



ISSN 1406-0485

EESTI VABARIIK



PATENDILEHT

EESTI



PATENDIAMETI AMETLIK VÄLJAANNE

1
2010
TALLINN

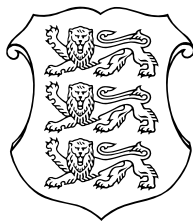

ISSN 1406-0485

EESTI VABARIIK

P
EESTI
PATENDILEHT

**PATENDIAMETI
AMETLIK VÄLJAANNE**

XVI aastakäik

**Käesolevas numbris
esitatud andmed
loetakse avaldatuks
15. veebruaril 2010. a.**

1
2010
**VEEBRUAR
TALLINN**

Eesti Patendilehte antakse välja patendiseaduse (jõustunud 23.05.1994) alusel.
The Estonian Patent Gazette is the official publication of the Estonian Patent Office.
Published under Patent Law of the Republic of Estonia (Coming into force 23 May 1994).
Date of publication of the data presented in this issue - 15 February 2010.

Patendiameti
infoosakond
Toompuiestee 7
15041 Tallinn
Tel 627 7907
Faks 627 7943
E-post Info@epa.ee

The Information Department
of the Estonian Patent Office
Toompuiestee 7
15041 Tallinn, ESTONIA
Phone +372 627 7907
Fax +372 627 7943
E-mail Info@epa.ee

Levitaja

Eesti Patendiraamatukogu
Olevimägi 8/10
10123 Tallinn
Tel 641 1248
Faks 641 1018
E-post patent@patentlib.ee

Distributor

Estonian Patent Library
Olevimägi 8/10
10123 Tallinn, ESTONIA
Phone +372 641 1248
Fax +372 641 1018
E-mail patent@patentlib.ee

SISUKORD**CONTENTS**

Bibliograafiliste andmete identifitseerimise rahvusvahelised numberkoodid (INID-koodid)	6
Riikide, teiste ühenduste ja valitsustevaheliste organisatsioonide koodid	7
I. EESTI PATENDID	8
BA1A. Avaldatud patenditaotlused	8
BB2A. Avaldatud rahvusvaheliste taotluste patendinõudluse tõlked	-
FG4A. Väljaantud patendid	10
GB1A. Avaldatud patenditaotluste õigusliku staatuse muudatused	40
HZ1A. Avaldatud patenditaotluste andmete parandused ja muudatused	41
LD4A. Muudatused patentides	-
TZ4A. Registreeringu andmete parandused ja muudatused	42
PZ4A. Patentide õigusliku staatuse muudatused	-
MZ4A. Patentide kehtivuse lõppemine	43
II. EUROOPA PATENDID	47
BB2A. Avaldatud Euroopa patenditaotluste patendinõudluse tõlked	47
FG4A. Eestis kehtivate Euroopa patentide patendikirjelduse tõlked	48
HH2A/HH4A. Euroopa patenditaotluste ja Eestis kehtivate Euroopa patentide patendikirjelduse tõlgete parandused	85
LD4A. Muudatused Euroopa patentides	-
TZ4A. Registreeringu andmete parandused ja muudatused	86
PZ4A. Euroopa patentide õigusliku staatuse muudatused	87
MZ4A. Euroopa patentide kehtivuse lõppemine	88
III. MEDITSIINITOODETE JA TAIME- KAITSETOODETE TÄIENDAV KAITSE	92
AA1Y. Täiendava kaitse taotlused	92

Internationally Agreed Numbers for the Identification of Data (INID Codes)	6
List of Codes of States, Other Entities and Intergovernmental Organizations	7
I. ESTONIAN PATENTS	8
BA1A. Published Patent Applications	8
BB2A. Translations of the Patent Claims of Published International Applications	-
FG4A. Granted Patents	10
GB1A. Changes in the Legal Status of Published Patent Applications	40
HZ1A. Corrections and Amendments to the Data Concerning Published Patent Applications	41
LD4A. Amendments to Patents	-
TZ4A. Corrections and Amendments to Registration Data	42
PZ4A. Changes in the Legal Status of Patents	-
MZ4A. Expiry of the Term of Patent Validity	43
II. EUROPEAN PATENTS	47
BB2A. Translations of the Claims of Published European Patent Applications	47
FG4A. Translations of the Specifications of European Patents Valid in Estonia	48
HH2A/HH4A. Corrections of the European Patent Applications and Translations of the Specifications of European Patents Valid in Estonia	85
LD4A. Amendments to European Patents	-
TZ4A. Corrections and Amendments to Registration Data	86
PZ4A. Changes in the Legal Status of European Patents	87
MZ4A. Expiry of the term of Validity of European Patents	88
III. SUPPLEMENTARY PROTECTION OF MEDICINAL PRODUCTS AND PLANT PROTECTION PRODUCTS	92
AA1Y. Applications for Supplementary Protection	92

FG1Y. Täiendava kaitse andmine	93	FG1Y. Grant of Supplementary Protection	93
FC1Y. Tagasilükatud täiendava kaitse taotlused	-	FC1Y. Refused Applications for Supplementary Protection	-
MZ1Y. Täiendava kaitse kehtivuse lõppemine	-	MZ1Y. Expiry of the term of Validity of Supplementary Protection	-
MC1Y. Täiendava kaitse tühistamine	-	MC1Y. Annulment of Supplementary Protection	-
IV. LITSENTSID JA PANDID	-	IV. LICENCES AND PAWNS	-
QB4A/QB1Y. Litsentside registreerimine	-	QB4A/QB1Y. Registering of Licences	-
RC4A/RC1Y. Pantide registreerimine	-	RC4A/RC1Y. Registering of Pawning	-
V. LOENDID	94	V. LISTS	94
BA1A. Avaldatud patenditaotluste süstemaatiline loend	94	BA1A. Systematic List of Published Patent Applications	94
FG4A. Väljaantud patentide süstemaatiline loend	94	FG4A. Systematic List of Granted Patents	94
FG4A. Väljaantud patentide patenditaotluste numbriline loend	94	FG4A. Numerical List of the Patent Applications of Granted Patents	94
BB2A. Avaldatud rahvusvaheliste taotluste patendinõudluse tõlgete numbriline loend	-	BB2A. Numerical List of the Translations of the Patent Claims of Published International Applications	-
BB2A. Avaldatud Euroopa patenditaotluste patendinõudluse tõlgete numbriline loend	94	BB2A. Numerical List of the Translations of the Claims of Published European Patent Applications	94
FG4A. Eestis kehtivate Euroopa patentide süstemaatiline loend	95	FG4A. Systematic List of European Patents Valid in Estonia	95
FG4A. Eestis kehtivate Euroopa patentide numbriline loend	96	FG4A. Numerical List of European Patents Valid in Estonia	96
FG4A. Eestis kehtivate Euroopa patentide patendi- kirjelduse tõlgete numbriline loend	97	FG4A. Numerical List of the Translations of the Specifications of European Patents Valid in Estonia	97
AA1Y. Täiendava kaitse taotluste numbriline loend	99	AA1Y. Numerical List of Supplementary Protection Applications	99
FG1Y. Täiendava kaitse tunnistuste numbriline loend	99	FG1Y. Numerical List of Supplementary Protection Certificates	99
AA1Y. Tagasilükatud täiendava kaitse taotluste numbriline loend	-	AA1Y. Numerical List of Refused Applications for Supplementary Protection	-
AASTALOENDID 2009	100	ANNUAL LISTS 2009	100
BA1A. Avaldatud patenditaotluste süstemaatiline loend	100	BA1A. Systematic List of Published Patent Applications	100
BA1A. Avaldatud patenditaotluste numbriline loend	102	BA1A. Numerical List of Published Patent Applications	102

BA1A. Avaldatud patenditaotluste patenditaotlejate tähestikuline loend	104	BA1A. Alphabetical List of the Applicants of Published Patent Applications	104
FG4A. Väljaantud patentide süstemaatiline loend .	105	FG4A. Systematic List of Granted Patents	105
FG4A. Väljaantud patentide numbriline loend	111	FG4A. Numerical List of Granted Patents	111
FG4A. Patendiomanike tähestikuline loend	117	FG4A. Alphabetical List of Patentees	117
FG4A. Väljaantud patentide patenditaotluste numbriline loend	118	FG4A. Numerical List of the Patent Applications of Granted Patents	118
BB2A. Avaldatud rahvusvaheliste taotluste patendinõudluse tõlgete numbriline loend -		BB2A. Numerical List of the Translations of the Patent Claims of Published International Applications	-
BB2A. Avaldatud Euroopa patenditaotluste patendinõudluse tõlgete numbriline loend .	119	BB2A. Numerical List of the Translations of the Claims of Published European Patent Applications	119
FG4A. Eestis kehtivate Euroopa patentide süstemaatiline loend	120	FG4A. Systematic List of European Patents Valid in Estonia	120
FG4A. Eestis kehtivate Euroopa patentide numbriline loend	140	FG4A. Numerical List of European Patents Valid in Estonia	140
FG4A. Eestis kehtivate Euroopa patentide patendiomanike tähestikuline loend	150	FG4A. Alphabetical List of Patentees of European Patents Valid in Estonia	150
AA1Y. Täiendava kaitse taotluste numbriline loend	163	AA1Y. Numerical List of Supplementary Protection Applications	163
FG1Y. Täiendava kaitse tunnistuste numbriline loend	163	FG1Y. Numerical List of Supplementary Protection Certificates	163
AA1Y. Tagasilükatud täiendava kaitse taotluste numbriline loend	-	AA1Y. Numerical List of Refused Applications for Supplementary Protection	-
ND4A. KEHTIVATE PATENTIDE NUMBRILINE LOEND SEISUGA 31.12.2009	164	ND4A. NUMERICAL LIST OF VALID PATENTS BY DEC. 31, 2009	164
ND4A. EESTIS KEHTIVATE EUROOPA PATENTIDE NUMBRILINE LOEND SEISUGA 31.12.2009	166	ND4A. NUMERICAL LIST OF EUROPEAN PATENTS VALID IN ESTONIA BY DEC. 31, 2009	166
ND1Y. KEHTIVATE TÄIENDAVA KAITSE SAANUD MEDITSIINITOODETE JA TAIMEKAITSETOODETE TUNNISTUSTE NUMBRILINE LOEND SEISUGA 31.12.2009	173	ND1Y. NUMERICAL LIST OF BASIC PATENTS OF SUPPLEMENTARY PROTECTION CERTIFICATES OF MEDICINAL PRODUCTS AND PLANT PROTECTION PRODUCTS BY DEC. 31, 2009	173
VI. PATENDIALASED ÕIGUSAKTID JA MUU INFO	174	VI. LEGAL ACTS AND INFORMATION .	174
Riiklikus patendivolinike registris registreeritud patendivolinike nimekiri	174	List of Patent Attorneys, Registered in the Estonian State Register of Patent Attorneys	178

**BIBLIOGRAAFILISTE ANDMETE
IDENTIFITSEERIMISE RAHVUSVAHELISED
NUMBERKOODID (INID-KOODID)
WIPO Standard ST. 9**

**INTERNATIONALLY AGREED NUMBERS FOR
THE IDENTIFICATION OF DATA
(INID CODES)
WIPO Standard ST. 9**

- | | |
|---|---|
| (10) Registreeringu number | (10) Registration number |
| (11) Dokumendi number | (11) Number of the document |
| (12) Dokumendi liik | (12) Kind of the document |
| (19) Dokumendi väljaandnud asutuse nimetus | (19) Name of the office publishing the document |
| (21) Patenditaotluse number | (21) Application number |
| (22) Patenditaotluse esitamise kuupäev | (22) Date of filing of the application |
| (23) Patendiseaduse § 8 lõikes 3 nimetatud teabe avalikustamise kuupäev | (23) Date of making available to the public of the information provided in § 8(3) of the Patent Act |
| (24) Patendi kehtivuse alguse kuupäev | (24) Date of the beginning of validity of the patent |
| (30) Prioriteediandmed (kuupäev, riigi või rahvusvahelise organisatsiooni kood, taotluse number) | (30) Priority data (date, code identifying the State or international organization, application number) |
| (43) Patenditaotluse avaldamise kuupäev | (43) Date of publication of the patent application |
| (45) Patendikirjelduse avaldamise kuupäev | (45) Date of publication of the specification |
| (48) Muudetud patenditaotluse või patendikirjelduse avaldamise kuupäev | (48) Date of issuance of the corrected patent application or specification |
| (51) Rahvusvahelise patendiklassifikatsiooni indeks(id) | (51) Symbol of the International Patent Classification |
| (54) Leiutise nimetus | (54) Title of the invention |
| (57) Leiutise olemuse lühikokkuvõte | (57) Abstract |
| (60) Leiutise olemust muutvate varasema patenditaotluse paranduste ja täienduste esitamise kuupäev ja varasema patenditaotluse number | (60) Filing date of the amendments and corrections to the previous patent application which alter the subject matter of the invention and number of the previous patent application |
| (62) Varasema patenditaotluse, millest patenditaotlus on eraldatud, esitamise kuupäev ja number | (62) Filing date and number of the earlier patent application from which patent application has been divided up |
| (66) Varasema, jätkatud taotluse esitamise kuupäev ja number | (66) Filing date and number of the earlier, continued patent application |
| (68) Aluspatendi number | (68) Number of the basic patent |
| (71) Patenditaotleja | (71) Applicant |
| (72) Leiutise autor | (72) Inventor |
| (73) Patendiomanik | (73) Owner |
| (74) Patendivolnik või ühine esindaja | (74) Patent attorney or common representative |
| (83) Bioloogilise aine, sealhulgas mikroorganismi tüve deponeerimise andmed | (83) Data of the deposit of a biological material, including microorganism strain |
| (85) Rahvusvahelise patenditaotluse siseriiklikku menetlusse esitamise kuupäev | (85) Date of entry into the national phase for the international patent application |
| (86) PCT taotluse esitamise andmed (rahvusvahelise esitamise kuupäev, taotluse number) | (86) Filing data of the PCT application (international filing date, application number) |
| (92) Meditsiini- või taimekaitsetoote registreerimist tõendava dokumendi number ja väljaandmise kuupäev | (92) For an SPC, number and date of the authorization to place the product on the market |
| (94) Täiendava kaitse kehtivuse lõppemise kuupäev | (94) Calculated date of expiry of the SPC or the duration of the SPC |
| (95) Meditsiini- või taimekaitsetoote nimetus | (95) Name of the product in respect of which the SPC has been applied for or granted |
| (96) Euroopa patenditaotluse andmed (esitamise kuupäev, number) | (96) Filing data of the European patent application (date of filing, application number) |
| (97) Euroopa patendi andmed (väljaandmisest teatamise kuupäev, number) | (97) Data of the European patent (date of mention of the grant of the patent, patent number) |

**RIIKIDE, TEISTE ÜHENDUSTE JA VALITSUSTEVÄHELISTE
ORGANISATSIOONIDE KOODID**

AD	Andorra	DZ	Alžeeria	JM	Jamaica	PW	Belau
AE	Araabia	EA	Euraasia	JO	Jordaania	PY	Paraguay
	Ühendemiraadid		Patendiorganisat-	JP	Jaapan	QA	Katar
AF	Afganistan		sioon (EAPO)	KE	Kenya	RO	Rumeenia
AG	Antigua ja Barbuda	EC	Ecuador	KG	Kõrgõzstan	RS	Serbia
AI	Anguilla	EE	Eesti	KH	Kambodža	RU	Venemaa
AL	Albaania	EG	Egiptus	KI	Kiribati	RW	Rwanda
AM	Armeenia	EH	Lääne-Sahara	KM	Komoorid	SA	Saudi Araabia
AN	Hollandi Antillid	EM	Siseturu	KN	Saint Kitts ja Nevis	SB	Saalomoni Saared
AO	Angola		Ühtlustamise	KP	Põhja-Korea	SC	Seišellid
AP	Aafrika Regionaalne		Amet (kaubamärgid	KR	Lõuna-Korea	SD	Sudaan
	Tööstusomandi Orga-		ja tööstusdisaini-	KW	Kuveit	SE	Rootsi
	nisatsioon (ARIPO)		lahendused) (OHIM)	KY	Kaimanisaared	SG	Singapur
AR	Argentina	EP	Euroopa	KZ	Kasahstan	SH	Saint Helena
AS	Ameerika Samoa		Patendiamet (EPO)	LA	Laos	SI	Sloveenia
AT	Austria	ER	Eritrea	LB	Liibanon	SK	Slovakkia
AU	Austraalia	ES	Hispaania	LC	Saint Lucia	SL	Sierra Leone
AW	Aruba	ET	Etiopia	LI	Liechtenstein	SM	San Marino
AZ	Aserbaidžaan	FI	Soome	LK	Sri Lanka	SN	Senegal
BA	Bosnia ja	FJ	Fidži	LR	Libeeria	SO	Somaalia
	Hertsegoviina	FK	Falklandi (Malviini)	LS	Lesotho	SR	Suriname
BB	Barbados		saared	LT	Leedu	ST	São Tomé ja Príncipe
BD	Bangladesh	FM	Mikroneesia	LU	Luksemburg	SV	El Salvador
BE	Belgia	FO	Fääri saared	LV	Läti	SY	Süüria
BF	Burkina Faso	FR	Prantsusmaa	LY	Liibüa	SZ	Svaasimaa
BG	Bulgaaria	GA	Gabon	MA	Maroko	TC	Turks ja Caicos
BH	Bahrein	GB	Ühendkuningriik	MC	Monaco	TD	Tšaad
BI	Burundi		(Suurbritannia)	MD	Moldova	TG	Togo
BJ	Benin	GC	Pärsia Lahe	ME	Montenegro	TH	Tai
BM	Bermuda		Koostöönõukogu	MG	Madagaskar	TJ	Tadžikistan
BN	Brunei	GD	Grenada	MH	Marshalli Saared	TM	Türkmenistan
BO	Boliivia	GE	Gruusia	MK	Makedoonia	TN	Tuneesia
BR	Brasiilia	GG	Guernsey	ML	Mali	TO	Tonga
BS	Bahama	GH	Ghana	MM	Myanmar (Birma)	TL	Ida-Timor
BT	Bhutan	GI	Gibraltar	MN	Mongoolia	TR	Türgi
BV	Bouvet' saar	GL	Gröönimaa	MO	Macao	TT	Trinidad ja Tobago
BW	Botswana	GM	Gambia	MP	Põhja-Mariaanid	TV	Tuvalu
BX	Beneluxi	GN	Guinea	MR	Mauritaania	TW	Taiwan (Hiina provints)
	Kaubamärgiamet	GQ	Ekvatoriaal-Guinea	MS	Montserrat	TZ	Tansaania
	(BBM) ja Beneluxi	GR	Kreeka	MT	Malta	UA	Ukraina
	Tööstusdisainilahen-	GS	Lõuna-Georgia ja	MU	Mauritius	UG	Uganda
	duste Amet (BBDM)		Lõuna-Sandwichi	MV	Maldiivid	US	Ameerika
BY	Valgevene		saared	MW	Malawi		Ühendriigid
BZ	Belize	GT	Guatemala	MX	Mehhiko	UY	Uruguay
CA	Kanada	GW	Guinea-Bissau	MY	Malaisia	UZ	Usbekistan
CF	Kesk-Aafrika	GY	Guyana	MZ	Mosambiik	VA	Vatikan (Püha Tool)
	Vabariik	HK	Hongkong	NA	Namiibia	VC	Saint Vincent ja
CG	Kongo	HN	Honduras	NE	Niger		Grenadiinid
CH	Šveits	HR	Horvaatia	NG	Nigeeria	VE	Venezuela
CI	Côte d'Ivoire	HT	Haiti	NI	Nicaragua	VG	Neitsisaared
CK	Cooki saared	HU	Ungari	NL	Holland	VN	Vietnam
CL	Tšiili	IB	Maailma	NO	Norra	VU	Vanuatu
CM	Kamerun		Intellektuaalomandi	NP	Nepal	WO	Maailma
CN	Hiina		Organisatsiooni	NR	Nauru		Intellektuaalomandi
CO	Kolumbia		(WIPO) Rahvus-	NZ	Uus-Meremaa		Organisatsioon
CR	Costa Rica		vaheline Büroo	OA	Aafrika Intellektuaal-		(WIPO) (Rahvus-
CU	Kuuba	ID	Indoneesia		omandi Organisat-		vaheline Büroo)
CV	Cabo Verde	IE	Iiri		sioon (OAPI)	WS	Samoa
CY	Küpros	IL	Iisrael	OM	Omaan	YE	Jeemen
CZ	Tšehhi	IM	Man'i saar	PA	Panama	ZA	Lõuna-Aafrika Vabariik
DE	Saksamaa	IN	India	PE	Peruu	ZM	Sambia
DJ	Djibouti	IQ	Iraak	PG	Paapua Uus-Guinea	ZR	Zaire
DK	Taani	IR	Iraan	PH	Filipiinid	ZW	Zimbabwe
DM	Dominica	IS	Island	PK	Pakistan		
DO	Dominikaani	IT	Itaalia	PL	Poola		
	Vabariik	JE	Jersey	PT	Portugal		

I OSA EESTI PATENDID

BA1A. AVALDATUD PATENDITAOTLUSED

Teade avaldatakse "Patendiseaduse" § 24 lõike 6 alusel.

Teates avaldatud andmed (leiutise nimetus, taotleja ja autori andmed), samuti "Patendiseaduse" § 24 lõike 1 kohaselt avaldatud patenditaotluse dokumendid avaldatakse patenditaotleja esitatud redaktsioonis (majandusministri 29. detsembri 1998. a määrusega nr 50 kehtestatud "Patenditaotluse avaldamise korra" punkt 18 (RTL 1999, 10, 117)).

<p>(51) A01H 4/00 (2010.01) (11) 200800036 A</p> <p>(22) 27.05.2008</p> <p>(21) P200800036</p> <p>(71) Eesti Maaviljeluse Instituut Teaduse 13, Saku, 75501 Harju maakond, EE</p> <p>(72) Katrin Kotkas Silla 3, Saku, 75501 Harju maakond, EE Viive Rosenberg EMMI24, Metsanurme küla, Saku, 75506 Harju maakond, EE</p> <p>(74) Sirje Kahu Patendibüroo Ustervall OÜ, Kivi 21-6, 51009 Tartu, EE</p> <p>(54) Meetod kartuli viirushaigustest tervendamiseks ja parandatud omadustega meristeemkloonide loomiseks, viirusvaba kartuli meristeemtaim ning viirusvaba kartul</p>	<p>midiiin-5-üül}vinüül}(4R, 6S)-2,2-dimetüül[1,3] dioksaan-4-üül}atsetaadi valmistamismeetod</p>
<hr/>	
<p>(51) A61K 31/505 (2009.01) (11) 200900043 A C07D 239/42 (2009.01) C07D 405/06 (2009.01) C07F 9/6512 (2009.01)</p> <p>(22) 15.02.2000</p> <p>(21) P200900043</p> <p>(30) 17.02.1999, GB, 9903472.0</p> <p>(62) 15.02.2000, P200100430</p> <p>(71) AstraZeneca AB SE-151 85 Södertälje, SE Shionogi & Co. Ltd. 1-8, Doshomachi 3-chome, Chuo-ku, Osaka 541-0045, JP</p> <p>(72) Haruo Koike 1-3 Kuise Terajima 2-Chome, Amagasaki-shi, Hyogo 660-0813, JP Mikio Kabaki 1-3 Kuise Terajima 2-Chome, Amagasaki-shi, Hyogo 660-0813, JP Nigel Philip Taylor Alderley Park, Macclesfield, Cheshire SK10 4TG, GB Louis Joseph Diorazio Mereside, Alderley Park, Macclesfield, Cheshire SK10 4TG, GB</p> <p>(74) Lembit Mitt AAA Patendibüroo OÜ, Tartu mnt 16, 10117 Tallinn, EE</p> <p>(54) Tert-butüül-(E)-(6-{2-[4-(4-fluorofenüül)-6-iso-propüül-2-[metüül(metüülsulfonüül)amino]püri-</p>	<p>(51) C07H 19/00 (2010.01) (11) 200800040 A C07H 19/073 (2010.01)</p> <p>(22) 02.06.2008</p> <p>(21) P200800040</p> <p>(71) Tallinna Tehnikaülikool Ehitajate tee 5, 19086 Tallinn, EE AS Cambrex Tallinn Akadeemia tee 15/1, 12618 Tallinn, EE AS Vähiuuringute Tehnoloogia Arenduskeskus Akadeemia tee 15, 12618 Tallinn, EE</p> <p>(72) Margus Lopp Trummi 32s, 12617 Tallinn, EE Anne Paju Akadeemia tee 48-95/102, 12613 Tallinn, EE Artur Jõgi Akadeemia tee 15-430, 12618 Tallinn, EE Kaarel Siirde Kivila 6-13, 13917 Tallinn, EE Raissa Jäälaid Akadeemia tee 48-53, 12613 Tallinn, EE Tõnis Pehk Trummi 6-21, 12616 Tallinn, EE</p> <p>(74) Tallinna Tehnikaülikool</p> <p>(54) 4'-arüül-2',3'-dideoksünukleosiidi analoogid</p>
<hr/>	
<p>(51) C30B 25/02 (2010.01) (11) 200800038 A C30B 29/04 (2010.01) C30B 29/60 (2010.01)</p> <p>(22) 29.05.2008</p> <p>(21) P200800038</p> <p>(71) Eesti Nanotehnoloogiate Arenduskeskuse AS Riia 142, 51014 Tartu, EE</p> <p>(72) Peter Kopylov Ostrovityanova 53-27, 129337 Moskva, RU Alexander Obraztsov Yaroslavskoe shosse 120-2-192, 129337 Moskva, RU</p> <p>(74) Mikk Putk Sarap ja Partnerid Patendibüroo, Akadeemia tee 19, 12618 Tallinn, EE</p> <p>(54) Teemandist nano-otsak ja meetod nano-otsaku valmistamiseks</p>	

(51) **F01C 1/063 (2010.01)** (11) **200800041 A**
F02B 53/00 (2010.01)

(22) 10.06.2008

(21) P200800041

(71) Veli-Ott Lüsi

Pärnu mnt 161-4, 11624 Tallinn, EE

(72) Veli-Ott Lüsi

Pärnu mnt 161-4, 11624 Tallinn, EE

(54) Samateljelijelise võnkreduktoril baseeruv mahtmasin ja samateljeline võnkreduktor

(51) **F03G 7/00 (2010.01)** (11) **200800042 A**
C01B 31/00 (2010.01)

(22) 10.06.2008

(21) P200800042

(66) 30.05.2008, P200800039

(71) Tartu Ülikool

Ülikooli 18, 50090 Tartu, EE

Carbon.ee OÜ

Riia 185, 51014 Tartu, EE

(72) Janno Torop

Mõniste küla, Mõniste vald, 66002 Võru maakond, EE

Jaan Leis

Pikk 82-4, 50606 Tartu, EE

Mati Arulepp

Riia 71-1, 50406 Tartu, EE

Urmas Johanson

Pärna 4-5, 50603 Tartu, EE

Alvo Aabloo

Orava 28, 51009 Tartu, EE

(74) Mart Enn Koppel

Patendibüroo Koppel OÜ,

Kajaka 4-10, 11317 Tallinn, EE

(54) Aktuaator

(51) **F24D 10/00 (2010.01)** (11) **200800046 A**

(22) 10.07.2008

(21) P200800046

(71) Tallinna Tehnikaülikool

Ehitajate tee 5, 19086 Tallinn, EE

(72) Teet-Andrus Kõiv

Ravi 19-14, 10138 Tallinn, EE

Alvar Toode

Nõgikikka 13-2, 13516 Tallinn, EE

Allan Hani

Särje 51/Kanarbiku 1, 10922 Tallinn, EE

(54) Soojusvõrgu dimensioneerimise meetod

(51) **G01N 21/64 (2009.01)** (11) **200800031 A**

(22) 21.05.2008

(21) P200800031

(71) OÜ AMS Elektronik

Asula 3, 11312 Tallinn, EE

(72) Uno Holmberg

Raja 11, Aruküla, Raasiku vald,

75201 Harju maakond, EE

(74) Riho Pikkor

Patendibüroo Turvaja OÜ,

Liivalaia 22, 10118 Tallinn, EE

(54) Meetod hapnikusisalduse mõõtmiseks optilise hapnikuanduriga

(51) **G01N 27/447 (2010.01)** (11) **200800037 A**
B01L 3/00 (2010.01)

(22) 27.05.2008

(21) P200800037

(71) Tallinna Tehnikaülikool

Ehitajate tee 5, 19086 Tallinn, EE

(72) Andrus Seiman

Mustamäe tee 159-54, 12913 Tallinn, EE

Merike Vaher

E. Vilde tee 92-29, 12914 Tallinn, EE

Mihkel Kaljurand

Mustamäe tee 177-93, 12913 Tallinn, EE

(54) Kapillaarelektroforeesi ristsisendseade kapillaar-elektroforeesi analüsaatorisse proovi sisestamiseks

PCT

(51) **H03M 1/12 (2010.01)** (11) **200900083 A**

(85) 16.11.2009

(21) P200900083

(30) 17.04.2007, US, 60/912269

(86) PCT/EE2008/000008, 16.04.2008

(71) Tallinna Tehnikaülikool

Ehitajate tee 5, 19086 Tallinn, EE

(72) Ivars Bilinskis

Caunes 10/1-60, LV-1006 Riia, LV

Mart Min

Sõpruse pst 188A-4, 13424 Tallinn, EE

Aleksanders Ribakovs

Raunas 22A-21, LV-1039 Riia, LV

(54) Siinussignaali ristumisel põhinev meetod andmehõiveks ebaühtlastelt sensorvõredelt

PCT

(51) **H03M 1/12 (2010.01)** (11) **200900084 A**
A61B 5/053 (2010.01)

(85) 16.11.2009

(21) P200900084

(30) 17.04.2007, US, 60/912233

(86) PCT/EE2008/000007, 16.04.2008

(71) Tallinna Tehnikaülikool

Ehitajate tee 5, 19086 Tallinn, EE

(72) Ivars Bilinskis

Caunes 10/1-60, LV-1006 Riia, LV

Mart Min

Sõpruse pst 188A-4, 13424 Tallinn, EE

Jurijs Artjuhs

Brivibas 318-13, LV-1006 Riia, LV

Paul Annus

Harju 5-12, 10146 Tallinn, EE

Raul Land

Akadeemia tee 7A-17, 12611 Tallinn, EE

Olev Märten

Sügislase 20/1, 11913 Tallinn, EE

(54) Ebaühtlase diskreetimise ja demoduleerimise meetod laiaribaliseks mitmesageduslikuks mõõtmiseks

FG4A. VÄLJAANTUD PATENDID

Patendid nr 05254 kuni 05279

Teade avaldatakse "Patendiseaduse" § 35 lõike 8 alusel.

EE 05254 B1

(11) **EE 05254 B1**

(51) Int.Cl.
A01N 1/00 (2009.01)
C05F 17/00 (2009.01)
F26B 5/06 (2009.01)

(12) **PATENDIKIRJELDUS**

(21) Patenditaotluse number: **P200200279**

(85) Rahvusvahelise patendi-
taotluse siseriiklikku
menetluse esitamise
kuupäev: **03.06.2002**

(86) Rahvusvahelise patendi-
taotluse number: **PCT/SE00/02429**

(86) Rahvusvahelise patendi-
taotluse esitamise kuupäev: **04.12.2000**

(30) Prioriteediandmed: **03.12.1999**
SE 9904433-1

(24) Patendi kehtivuse
alguse kuupäev: **04.12.2000**

(43) Patenditaotluse
avaldamise kuupäev: **16.06.2003**

(45) Patendikirjelduse
avaldamise kuupäev: **15.02.2010**

(73) Patendiomanik:
Promessa AB
Barkedal 7747, SE-474 96 Nösund, SE

(72) Leiutise autor:
Susanne Wiigh-Mäsak
Barkedal 7747, S-474 96 Nösund, SE

(74) Patendivolinik:
Arno Anijalg
Patendibüroo Ustervall OÜ
Kivi 21-6, 51009 Tartu, EE

(54) **Kõrvaldamise meetod ja seade**

(57) Leiutis käsitleb meetodit orgaanilise materjali töötlemiseks enne lagunemist või külmutuskuivatamist. Antud meetodi korral orgaaniline materjal, eelistatavalt jahutatud või külmutatud, allutatakse lõhustamisprotsessile. Järgnevalt materjal külmutuskuivatatakse ja ladustatakse lagunemiseks. Leiutis käsitleb ka lagundatavat konteinerit ja seadet esitatud meetodi teostamiseks.

(57) The invention relates to a method for treating organic material before decay or freeze drying. In the method, organic material, preferably refrigerated or frozen, is subjected to a splitting treatment. Subsequently, the material is freeze dried. Next, the material is deposited for decay. The invention also relates to a decayable container, as well as an apparatus for performing the disclosed method.

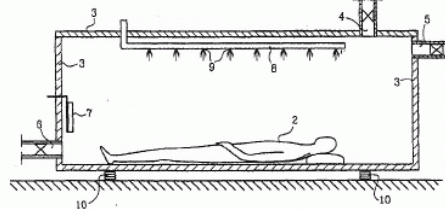

EE 05254 B1

EE 05255 B1

(11) **EE 05255 B1**

(51) Int.Cl.
A01N 51/00 (2009.01)
A01N 61/00 (2009.01)

(12) **PATENDIKIRJELDUS**

(21) Patenditaotluse number: P200000485	(73) Patendiomanik: Bayer Animal Health GmbH 51368 Leverkusen, DE
(85) Rahvusvahelise patendi- taotluse siseriiklikku menetlusse esitamise kuupäev: 22.08.2000	(72) Leiutise autorid: Kirkor Sirinyan Humperdinckstrasse 12, D-51467 Bergisch Gladbach, DE
(86) Rahvusvahelise patendi- taotluse number: PCT/EP99/00875	Hubert Dorn Pahlkestrasse 71, D-42115 Wuppertal, DE
(86) Rahvusvahelise patendi- taotluse esitamise kuupäev: 10.02.1999	Ulrich Heukamp Am Domberg 2, D-51515 Kürten, DE
(30) Prioriteediandmed: 23.02.1998 DE 19807633,9	(74) Patendivolinik: Jaak Ostrat OÜ Lasvet Suurtüki 4a, 10133 Tallinn, EE
(24) Patendi kehtivuse alguse kuupäev: 10.02.1999	
(43) Patenditaotluse avaldamise kuupäev: 15.02.2002	
(45) Patendikirjelduse avaldamise kuupäev: 15.02.2010	

(54) **Nahal kasutatavad parasititsiidide vettsisaldavad preparaadid**

(57) Leiutis käsitleb vett sisaldavaid preparaate parasititputukate ja lestade vastu võitlemiseks loomade nahal. Preparaadid on järgmise koostisega: a) imidaklopriid kontsentratsioonis 1 kuni 20 massiprotsenti preparaadi üldmassist; b) vesi kontsentratsioonis 2,5 kuni 15 massiprotsenti preparaadi üldmassist; c) alkoholide hulgast valitud lahustid või vajadusel asendatud pürrolidoonid kontsentratsioonis vähemalt 20 massiprotsenti preparaadi üldmassist; d) tsükliliste karbonaatide või laktoomide hulgast valitud lahustid kontsentratsioonis 5 kuni 50 massiprotsenti preparaadi üldmassist; e) vajadusel teised paksendite, määrdeainete, värvainete, antioksidantide, propellentide, säilitusainete, deposiitainete ja emulgaatorite hulgast valitud abiainedkontsentratsioonis 0,025 kuni 10 massiprotsenti preparaadi üldmassist ja f) vajadusel teised toimeained.

(57) The invention relates to aqueous formulations for combating parasitic insects and acarina on the skin of animals, having the following composition: a) imidacloprid in a concentration of 1 to 20 wt. % in relation to the overall weight of the formulation; b) water in a concentration of 2.5 to 15 wt. % in relation to the overall weight of the formulation; c) solvents from the group of alcohols or optionally substituted pyrrolidone in a concentration of at least 20 wt. % in relation to the overall weight of the formulation; d) solvents from the group of cyclic carbonates or lactones in a concentration of 5 to 50.0 wt. % in relation to the overall weight of the formulation; e) optionally, other adjuvants from the group of the thickening agents, spreading agents, colorants, anti-oxidants, expanding agents, preserving agents, deposit builders and emulgators in a concentration of 0.025 to 10 wt. % in relation to the overall weight of the formulation and f) if desired, further active compounds.

EE 05255 B1

EE 05256 B1

(11) **EE 05256 B1**

(51) Int.Cl.
A61K 9/20 (2009.01)
A61K 9/16 (2009.01)
A61K 31/44 (2009.01)
A61K 9/48 (2009.01)

(12) **PATENDIKIRJELDUS**

(21) Patenditaotluse number: P200300235	(73) Patendiomanik: Nycomed GmbH Byk-Gulden-Strasse 2, 78467 Konstanz, DE
(85) Rahvusvahelise patendi- taotluse siseriiklikku menetlusse esitamise kuupäev: 18.06.2003	(72) Leiutise autorid: Rango Dietrich Im Tiergarten 16, 78465 Konstanz, DE Rudolf Linder Lindauerstr. 40, 78464 Konstanz, DE Hartmut Ney Peter-Thumb-Str. 46, 78464 Konstanz, DE
(86) Rahvusvahelise patendi- taotluse number: PCT/EP01/14307	(74) Patendivolinik: Enn Urgas Patendibüroo Turvaja OÜ Liivalaia 22, 10118 Tallinn, EE
(86) Rahvusvahelise patendi- taotluse esitamise kuupäev: 06.12.2001	
(30) Prioriteediandmed: 07.12.2000 EP 00126847.3	
(24) Patendi kehtivuse alguse kuupäev: 06.12.2001	
(43) Patenditaotluse avaldamise kuupäev: 15.08.2003	
(45) Patendikirjelduse avaldamise kuupäev: 15.02.2010	

(54) Ravimpreparaat, milles aktiivne ingredient on ühtlaselt dispergeeritud abiainetete alussegus, ning seda sisaldav doseerimisvorm

(57) Käesolev leiutis kuulub farmaatsiavaldkonda ning käsitleb aktiivset ingrediendi sisaldavat preparaati, millel on paremad omadused. Uudne preparaat leiab kasutust mitmesuguste farmatseutiliste doseerimisvormide valmistamisel. Preparaadi omapäraks on see, et aktiivne ingredient on ühtlaselt dispergeeritud abiainetete alussegus, viimane koosneb ühest või mitmest abiaainest, mis on valitud rasvalkoholi, triglütseriidi, osalise glütseriidi ja rasvhapppeestri seast.

(57) The present invention relates to the field of pharmaceutical technology and describes a novel advantageous preparation for an active ingredient. The novel preparation is suitable for producing a large number of pharmaceutical dosage forms. In the new preparation an active ingredient is present essentially uniformly dispersed in an excipient matrix composed of one or more excipients selected from the group of fatty alcohol, triglyceride, partial glyceride and fatty acid ester.

EE 05256 B1

EE 05257 B1

(11) **EE 05257 B1**

(51) Int.Cl.
A61K 9/72 (2007.01)
A61K 9/14 (2007.01)

(12) **PATENDIKIRJELDUS**

(21) Patenditaotluse number: P200200593	(73) Patendiomanik: Chiesi Farmaceutici S.p.A. Via Palermo, 26/A, I-43100 Parma, IT
(85) Rahvusvahelise patendi- taotluse siseriiklikku menetlusse esitamise kuupäev: 16.10.2002	(72) Leiutise autorid: John Nicholas Staniforth Via Palermo, 26/A, I-43100 Parma, IT
(86) Rahvusvahelise patendi- taotluse number: PCT/EP01/04338	David Alexander Vodden Morton Via Palermo, 26/A, I-43100 Parma, IT
(86) Rahvusvahelise patendi- taotluse esitamise kuupäev: 17.04.2001	Rajbir Gill Via Palermo, 26/A, I-43100 Parma, IT
(30) Prioriteediandmed: 17.04.2000 GB 0009469.8	Gaetano Brambilla Via Palermo, 26/A, I-43100 Parma, IT
27.06.2000 EP 00113608.4	Rossella Musa Via Palermo, 26/A, I-43100 Parma, IT
(24) Patendi kehtivuse alguse kuupäev: 17.04.2001	Lorenzo Ferrarini Via Palermo, 26/A, I-43100 Parma, IT
(43) Patenditaotluse avaldamise kuupäev: 15.04.2004	(74) Patendivolinik: Jaak Ostrat OÜ Lasvet Suurtüki 4a, 10133 Tallinn, EE
(45) Patendikirjelduse avaldamise kuupäev: 15.02.2010	

(54) **Kõvade pelletite vormis farmatseutilised preparaadid kuivpulberinhalaatoritele**

(57) Leiutis esitab kuivpulbrina inhaleerimise teel manustatava preparaadi, mis sobib kopsuhaigusi, nagu astma, põdevatele patsientidele toimeainete efektiivseks manustamiseks alumistesse hingamisteedesse. Täpsemalt esitab leiutis vabalt voolava kuivpulbrina inhaleerimise teel manustatava preparaadi, mida võib valmistada lihtsal viisil, mis on füüsikaliselt ning keemiliselt stabiilne ja võimaldab nii täpsete annuste kui ka nõrgatoimeliste toimeainete osakeste peenfraktsiooni manustamist suure või keskmise takistusega inhalatsioonivahendiga.

(57) The invention provides a formulation to be administered as dry powder for inhalation suitable for efficacious delivery of active ingredients into the low respiratory tract of patients suffering of pulmonary diseases such as asthma. In particular, the invention provides a formulation to be administered as dry powder for inhalation freely flowable, which can be produced in a simple way, physically and chemically stable and able of delivering either accurate doses and high fine particle fraction of low strength active ingredients by using a high or medium resistance device.

EE 05257 B1

EE 05258 B1

(11) **EE 05258 B1**

(51) Int.Cl.
A61K 31/4725 (2009.01)
A61K 31/5025 (2009.01)
A61P 9/10 (2009.01)
A61P 17/06 (2009.01)
A61P 19/02 (2009.01)
A61P 29/00 (2009.01)
A61P 31/12 (2009.01)
A61P 31/22 (2009.01)
A61P 35/00 (2009.01)
C07D 401/06 (2009.01)
C07D 401/12 (2009.01)
C07D 401/14 (2009.01)
C07D 403/12 (2009.01)
C07D 403/14 (2009.01)
C07D 405/14 (2009.01)
C07D 417/12 (2009.01)
C07D 487/04 (2009.01)
C07D 491/048 (2009.01)
C07D 495/04 (2009.01)
C07D 513/04 (2009.01)

(12) **PATENDIKIRJELDUS**

(21) Patenditaotluse number: P200200161	(73) Patendiomanik: Bayer Corporation 100 Bayer Road, Pittsburgh, PA 15205, US
(85) Rahvusvahelise patenditaotluse siseriiklikku menetlusse esitamise kuupäev: 27.03.2002	(72) Leiutise autorid: Autorite andmed lisalehel
(86) Rahvusvahelise patenditaotluse number: PCT/US00/26500	(74) Patendivolinik: Enn Urgas Patendibüroo Turvaja OÜ Liivalaia 22, 10118 Tallinn, EE
(86) Rahvusvahelise patenditaotluse esitamise kuupäev: 26.09.2000	
(30) Prioriteediandmed: 28.09.1999 US 09/407600	
(24) Patendi kehtivuse alguse kuupäev: 26.09.2000	
(43) Patenditaotluse avaldamise kuupäev: 15.08.2003	
(45) Patendikirjelduse avaldamise kuupäev: 15.02.2010	

(54) **Asendatud püridiinid ja püridasiinid, nende kasutamine angiogeneesi pärssimiseks ning neid sisaldav farmatseutiline kompositsioon**

(57) Käsitletakse angiogeneesi inhibeeriva toimega asendatud püridiine ja püridasiine üldstruktuuriga (I), milles A, B, D, E ja L rühmadest koosnev tsükkel on fentüülsükkel või lämmastikku sisaldav heterotsükkel; X ja Y on mis tahes määratletud sidestusrühm; R¹ ja R² on sõltumatud asendajad või võivad moodustada koos tsükliina määratletud silla; tsükkel J on arüül-, püridüül- või tsükloalküülrühm; G rühmaks võib olla mis tahes defineeritud asendaja. Samuti käsitletakse neid ühendeid sisaldavaid farmatseutilisi kompositsioone ning nende kasutamist imetajal ebanormaalse angiogeneesi või liigpermeaabluse ilmingutega iseloomustatava seisundi ravimiseks.

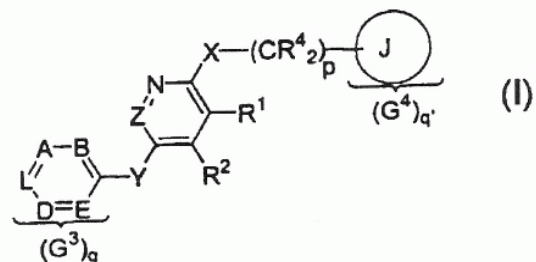

(57) Substituted pyridines and pyridazines having angiogenesis inhibiting activity and generalized structural formula (I) wherein the ring containing A, B, D, E, and L is phenyl or a nitrogen-containing heterocycle; groups X and Y may be any of a variety of defined linking units; R¹ and R² may be defined independent substituents or together may be a ring-defining bridge; ring J may be an aryl, pyridyl, or cycloalkyl group; and G groups may be any of a variety of defined substituents. Pharmaceutical compositions containing these materials, and methods of treating a mammal having a condition characterized by abnormal angiogenesis or hyperpermeability processes using these materials are also disclosed.

EE 05258 B1

EE 05258 B1

(72) Leiutise autorid:

Jacques P. Dumas
98 Farmview Road, Bethany, CT 06524, US

Stephen J. Boyer
233 Colony Street, Fairfield, CT 06430, US

Julie A. Dixon
81 Peck Road, Bethany, CT 06524, US

Teddy Kite Joe
1427 Jork Avenue, Apt. 2D, New York, NY 10021, US

Harold C. E. Kluender
27 Academy Road, Trumbull, CT 06611, US

Wendy Lee
282 Evergreen Avenue, Hamden, CT 06518, US

Dhanapalan Nagarathnam
52 Virginia Rail Drive, Bethany, CT 06524, US

Robert N. Sibley
1187 Mount Carmel Avenue, North Haven, CT 06473, US

Ning Su
121 October Hill Road, Hamden, CT 06518, US

EE 05259 B1

(11) **EE 05259 B1**

(51) Int.Cl.
A61K 31/56 (2008.04)
A61P 35/00 (2008.04)

(12) **PATENDIKIRJELDUS**

(21) Patenditaotluse number: P200300155	(73) Patendiomanik: Schering Aktiengesellschaft Müllerstrasse 178, 13353 Berlin, DE
(85) Rahvusvahelise patendi- taotluse siseriiklikku menetlusse esitamise kuupäev: 17.04.2003	(72) Leiutise autorid: Jens Hoffmann Walterstrasse 13, 16567 Mühlenbeck, DE
(86) Rahvusvahelise patendi- taotluse number: PCT/EP01/12005	Rosemarie Lichtner Belziger Strasse 39, 10823 Berlin, DE
(86) Rahvusvahelise patendi- taotluse esitamise kuupäev: 17.10.2001	Gerd Siemeister Reimerswalder Steig 26, 13503 Berlin, DE
(30) Prioriteediandmed: 18.10.2000 EP 00250341.5	Martin Schneider Schluchseestrasse 6a, 13469 Berlin, DE
	Ulrike Fuhrmann Charlottenburger Ufer 4, 10587 Berlin, DE
(24) Patendi kehtivuse alguse kuupäev: 17.10.2001	(74) Patendivolinik: Jaak Ostrat OÜ Lasvet Suurtüki 4a, 10133 Tallinn, EE
(43) Patenditaotluse avaldamise kuupäev: 15.08.2003	
(45) Patendikirjelduse avaldamise kuupäev: 15.02.2010	

(54) **Antiprogestiinide kasutamine hormoonsõltuvate haiguste profülaktikaks ja raviks**

(57) Leiutis käsitleb hormoonsõltuva haiguse, eriti rinnaäärnevähi preventsiiooni- või ravimeetodeid ja nende kasutamist imetajal, kasutades antiprogestiine, eriti antiprogestiini 11 β -(4-atsetüül-fenüül)-17 β -hüdrosü-17 α -(1,1,2,2,2-pentafluoroetüül)östra-4,9-dien-3-ooni või selle farmatseutiliselt aktsepteeritavat derivaati või analoogi. Leiutis käsitleb veel nimetatud antiprogestiine sisaldavaid farmatseutilisi kompositsioone.

(57) The present invention relates to methods and uses for preventing or treating hormone-dependent disease, in particular breast cancer, in a mammal by antiprogestins, in particular antiprogestin 11 β -(4-acetylphenyl)-17 β -hydroxy-17 α -(1,1,2,2,2-pentafluoroethyl)-estra-4,9-dien-3-one or a pharmaceutically acceptable derivative or analogue thereof. The invention further relates to pharmaceutical compositions comprising said antiprogestins.

EE 05259 B1

EE 05260 B1

(11) **EE 05260 B1**

(51) Int.Cl.
A61K 31/64 (2007.10)
A61K 31/155 (2007.10)
A61K 31/175 (2007.10)
A61P 31/10 (2007.10)

(12) **PATENDIKIRJELDUS**

(21) Patenditaotluse number: P200200242	(73) Patendiomanik: Bristol-Myers Squibb Company Lawrenceville-Princeton Road, Princeton, NJ 08543-4000, US
(85) Rahvusvahelise patenditaotluse siseriiklikku menetluse esitamise kuupäev: 03.05.2002	(72) Leiutise autor: Beth Anne Piper 80 Aunt Molly Road, Hopewell, NJ 08525, US
(86) Rahvusvahelise patenditaotluse number: PCT/US00/28311	(74) Patendivolinik: Jüri Käosaar Patendibüroo Käosaar & Co OÜ Tähe 94, 50107 Tartu, EE
(86) Rahvusvahelise patenditaotluse esitamise kuupäev: 13.10.2000	
(30) Prioriteediandmed: 03.11.1999 US 432465	
14.12.1999 US 460920	
(24) Patendi kehtivuse alguse kuupäev: 13.10.2000	
(43) Patenditaotluse avaldamise kuupäev: 15.12.2003	
(45) Patendikirjelduse avaldamise kuupäev: 15.02.2010	

(54) **Metformiini ja glüburidi kombinatsiooni väikese annuse kasutamine 2. tüüpi suhkurtõve esimese rea raviks**

(57) Leiutis käsitleb metformiini ja glüburidi kombinatsiooni kasutamist 2. tüüpi suhkurtõve esimese rea raviks. Samuti käsitletakse ülalmainitud preparaadi kasutamist 2. tüüpi suhkurtõve raviks ravimit mitte saanud patsientidel insuliiniresistentsuse ja/või söögijärgse veresuhkrutaseme muutuse vähendamiseks ja/või hemoglobiin-A_{1c} taseme alandamiseks ja/või söögijärgse insuliinitaseme suurendamiseks, ravides seeläbi suhkurtõbe.

(57) A use of a combination of metformin and glyburide is provided for first line treatment of type 2 diabetes. A use of the above formulation for treating diabetes in drug naive human patients is also provided to reduce insulin resistance and/or post-prandial glucose excursion and/or hemoglobin 1Ac, and/or increase post-prandial insulin, thereby the diabetes.

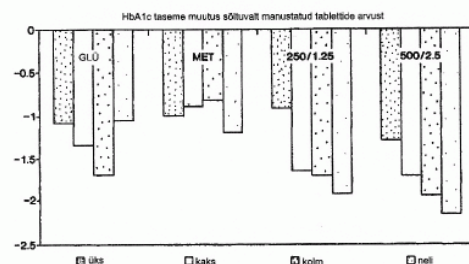

EE 05260 B1

EE 05261 B1

(11) **EE 05261 B1**

(51) Int.Cl.
A61K 33/24 (2008.04)
A61K 31/337 (2008.04)
A61K 31/7068 (2008.04)
A61P 35/00 (2008.04)
A61K 45/06 (2008.04)

(12) **PATENDIKIRJELDUS**

(21) Patenditaotluse number: P200200648	(73) Patendiomanik: AnorMED Inc. No. 200-20353 64th Avenue, Langley, British Columbia V2Y 1N5, CA
(85) Rahvusvahelise patendi- taotluse siseriiklikku menetlusse esitamise kuupäev: 18.11.2002	(72) Leiutise autorid: Mark Peart Smith Alderley Park, Macclesfield, Cheshire SK10 4TG, GB Trevor Charles Stephens Alderley Park, Macclesfield, Cheshire SK10 4TG, GB
(86) Rahvusvahelise patendi- taotluse number: PCT/GB01/02060	
(86) Rahvusvahelise patendi- taotluse esitamise kuupäev: 10.05.2001	
(30) Prioriteediamdmed: 18.05.2000 GB 0011903.2	(74) Patendivolinik: Heinu Koitel Patendi- & Kaubamärgibüroo Koitel OÜ Tartu mnt 65, 10115 Tallinn, EE
(24) Patendi kehtivuse alguse kuupäev: 10.05.2001	
(43) Patenditaotluse avaldamise kuupäev: 15.06.2004	
(45) Patendikirjelduse avaldamise kuupäev: 15.02.2010	

(54) Kombineeritud kemoterapia, milles kasutatakse (SP-4-3)-(cis-amiindikloro-[2-metüül-püridiin]plaatina (II) kombinatsioonis vähivastase vahendiga, mis ei põhine plaatinal

(57) Leiutis käsitleb farmatseutilist kompositsiooni, terapeutilist ühendprodukti ja ravimikomplekti, mis sisaldab steriilselt takistatud plaatina kompleksühendit ning vähivastast ainet, mis ei põhine plaatinal, ja farmatseutiliselt vastuvõetavat kandjat või lahendit; selle kasutamist ravimi tootmiseks, et inhibeerida vähirakkude kasvu vähki põdeval inimesel; vähki põdeval inimesel vähirakkude kasvu inhibeerimise meetodit, mis sisaldab niisugusele inimesele leiutise terapeutilise ühendprodukti või farmatseutilise kompositsiooni efektiivse koguse manustamist, mis inhibeerib vähirakkude kasvu; eriti kui steriilselt takistatud plaatina kompleksühend on (SP-4-3)-(cis-amiindikloro-[2-metüülpüridiin]plaatina (II) või selle eellasravim ning vähivastane aine, mis ei põhine plaatinal, on valitud taksooli, gemtsitabiini, navelbiini, doksiili, 5-FU ja taksoteeri seast.

(57) The invention relates to a pharmaceutical composition, a therapeutic combination product and a kit comprising a sterically hindered platinum coordination compound and a non-platinum based anti-cancer agent and a pharmaceutically-acceptable carrier or diluent; to the use thereof for the manufacture of a medicament for inhibiting the growth of tumour cells in a human afflicted therewith; to a method of inhibiting the growth of tumour cells in a human afflicted therewith which comprises administering to such human an effective tumour cell growth inhibiting amount of such a therapeutic combination product or of a pharmaceutical composition of the invention; in particular when the sterically hindered platinum coordination compound is (SP-4-3)-(cis)-amminedichloro-[2-methylpyridine]platinum (II), or a pro-drug thereof, and the non-platinum based anti-cancer agent is selected from Taxol, Gemcitabine, Navelbine, Doxil, 5-FU and Taxotere.

EE 05261 B1

EE 05262 B1

(19)  **EESTI VABARIIK**
PATENDIAMET(11) **EE 05262 B1**(51) Int.Cl.
A61K 38/22 (2009.01)
A61K 38/18 (2009.01)
A61K 48/00 (2009.01)
A61P 9/00 (2009.01)
A61P 9/14 (2009.01)
A61P 15/08 (2009.01)
A61P 35/00 (2009.01)(12) **PATENDIKIRJELDUS**(21) Patenditaotluse number: **P200200116**(85) Rahvusvahelise patendi-
taotluse siseriiklikku
menetluse esitamise
kuupäev: **04.03.2002**(86) Rahvusvahelise patendi-
taotluse number: **PCT/IL00/00525**(86) Rahvusvahelise patendi-
taotluse esitamise kuupäev: **04.09.2000**(30) Prioriteediandmed: **05.09.1999**
IL 131739**10.10.1999**
IL 132312(24) Patendi kehtivuse
alguse kuupäev: **04.09.2000**(43) Patenditaotluse
avaldamise kuupäev: **15.04.2003**(45) Patendikirjelduse
avaldamise kuupäev: **15.02.2010**

(73) Patendiomanik:

Yeda Research and Development Co. Ltd.
Weizmann Institute of Science, P.O. Box 95,
76100 Rehovot, IL

(72) Leiutise autorid:

Menachem Rubinstein
Hatomer Street 16, 54042 Givat Shmuel, IL**Batya Cohen**
Rechov Arlosoroff 182, 64923 Tel Aviv, IL**Dalit Barkan**
Vilkomitch Street 22a, 76448 Rehovot, IL

(74) Patendivolinik:

Harald Tehver
Patendibüroo Turvaja OÜ
Liivalaia 22, 10118 Tallinn, EE(54) **Leptiini või selle homoloogi või derivaadi kasutamine, farmatseutiline kompositsioon ja segu**

(57) Leiutis kirjeldab leptiini kasutamist, vajadusel koos VEGF inhibiitoritega, endoteelirakkude proliferatsiooni inhibeerimisel ja angiogeneesi moduleerimisel.

(57) Disclosed is the use of leptin, optionally together with VEGF inhibitors, in inhibition of endothelial cell proliferation and modulation of angiogenesis.

EE 05262 B1

EE 05263 B1

(11) **EE 05263 B1**

(51) Int.Cl.
A61K 39/395 (2008.04)
A61K 38/17 (2008.04)
A61K 38/19 (2008.04)
A61K 38/21 (2008.04)
A61K 31/00 (2008.04)
A61K 48/00 (2008.04)
A61P 25/00 (2008.04)

(12) **PATENDIKIRJELDUS**

(21) Patenditaotluse number: P200300582	(73) Patendiomanik: Ares Trading S.A. Zone Industrielle de l'Ouriettaz, CH-1170 Aubonne, CH
(85) Rahvusvahelise patendi- taotluse siseriiklikku menetlusse esitamise kuupäev: 22.12.2003	(72) Leiutise autor: Esther Shohami Meron Street 34/1, 90805 Mevasseret Zion, IL
(86) Rahvusvahelise patendi- taotluse number: PCT/EP02/05666	(74) Patendivolinik: Harald Tehver Patendibüroo Turvaja OÜ Liivalaia 22, 10118 Tallinn, EE
(86) Rahvusvahelise patendi- taotluse esitamise kuupäev: 23.05.2002	
(30) Prioriteediandmed: 25.05.2001 EP 01112067.2	
(24) Patendi kehtivuse alguse kuupäev: 23.05.2002	
(43) Patenditaotluse avaldamise kuupäev: 16.02.2004	
(45) Patendikirjelduse avaldamise kuupäev: 15.02.2010	

(54) **IL-18 inhibiitorite kasutamine kesknärvisüsteemi kahjustuste raviks või ennetamiseks**

(57) Leiutis käsitleb IL-18 inhibiitorite kasutamist ravimi valmistamiseks kesknärvisüsteemi kahjustuse, eriti traumaatilise ajukahjustuse, raviks ja/või ennetamiseks.

(57) The invention relates to the use of inhibitors of IL-18 in the preparation of a medicament for treatment and/or prevention of central nervous system injury, in particular of traumatic head injury.

EE 05263 B1

EE 05264 B1(11) **EE 05264 B1**

(51) Int.Cl.
A61K 47/12 (2009.01)
A61K 31/445 (2009.01)
A61P 1/00 (2009.01)
A61P 13/10 (2009.01)

(12) **PATENDIKIRJELDUS**

(21) Patenditaotluse number: P200100539	(73) Patendiomanik: Movetis N.V. Veediijk 58, B-2300 Turnhout, BE
(85) Rahvusvahelise patendi- taotluse siseriiklikku menetlusse esitamise kuupäev: 16.10.2001	(72) Leiutise autor: Eddy André Josée De Proost Janssen Pharmaceutica N.V., Turnhoutseweg 30, B-2340 Beerse, BE
(86) Rahvusvahelise patendi- taotluse number: PCT/EP00/03739	(74) Patendivolinik: Olga Treufeldt Patendibüroo Turvaja OÜ Liivalaia 22, 10118 Tallinn, EE
(86) Rahvusvahelise patendi- taotluse esitamise kuupäev: 20.04.2000	
(30) Prioriteediandmed: 29.04.1999 EP 99201335.9	
(24) Patendi kehtivuse alguse kuupäev: 20.04.2000	
(43) Patenditaotluse avaldamise kuupäev: 16.12.2002	
(45) Patendikirjelduse avaldamise kuupäev: 15.02.2010	

(54) **Prukalopriidi vesilahus suukaudseks manustamiseks ning selle valmistamise meetod**

(57) Leiutis käsitleb heade organoleptiliste omadustega suu kaudu manustatavat vesilahust, mis sisaldab prukalopriidi või selle farmatseutiliselt vastuvõetavaid happeliitsooli.

(57) The present invention is concerned with an oral aqueous solution comprising prucalopride or pharmaceutically acceptable acid addition salts thereof having good organoleptic properties.

EE 05264 B1

EE 05265 B1

(11) **EE 05265 B1**(51) Int.Cl.
A61M 15/06 (2009.01)(12) **PATENDIKIRJELDUS**

(21) Patenditaotluse number:	P200400123
(85) Rahvusvahelise patenditaotluse siseriiklikku menetlusse esitamise kuupäev:	13.12.2004
(86) Rahvusvahelise patenditaotluse number:	PCT/DE02/01712
(86) Rahvusvahelise patenditaotluse esitamise kuupäev:	13.05.2002
(24) Patendi kehtivuse alguse kuupäev:	13.05.2002
(43) Patenditaotluse avaldamise kuupäev:	15.02.2005
(45) Patendikirjelduse avaldamise kuupäev:	15.02.2010

(73) Patendiomanik:

Inhaleness B.V.
Rouwkooplaan 5,
2251 AP Voorschoten, NL

(72) Leiutise autor:

Ralf Esser
Wehrstr. 71, 53773 Hennef, DE

(74) Patendivolinik:

Raivo Koitel
Patendi- & Kaubamärgibüroo Koitel OÜ
Tartu mnt 65, 10115 Tallinn, EE

(54) **Inhalaator**

(57) Leiutis käsitleb inhalaatorit, mis sisaldab katalüütilise põleti ja selle põletiga ühendatud vesinikkusisaldava kütusemahuti (6), mahuti (15) sissehingamislisandite, näiteks aromaatsete ainete ja/või aktiivlisandite jaoks, vähemalt ühe sissevooluava (2) hapnikku sisaldava gaasisegu, sealhulgas õhu jaoks ning väljavooluava (3) aromaatsaid aineid ja/või aktiivlisandeid sisaldava sissehingamissegu jaoks.

(57) The invention relates to an inhaler comprising a catalytic burner and a fuel tank (6) containing hydrogen that is connected to said burner, a container (15) for inhalation additives such as aromatic substances and/or active ingredients, at least one inlet (2) for a gaseous mixture containing oxygen, in particular for air and an outlet (3) for an inhalation mixture containing aromatic substances and/or active ingredients.

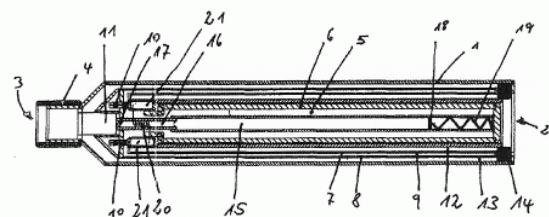

EE 05265 B1

EE 05266 B1

(11) **EE 05266 B1**

(51) Int.Cl.
B27K 3/15 (2009.01)
B27K 3/50 (2009.01)
B27K 3/52 (2009.01)

(12) **PATENDIKIRJELDUS**

(21) Patenditaotluse number: P200300352	(73) Patendiomanik: Kebony ASA Oscarsgate 30, 0352 Oslo, NO
(85) Rahvusvahelise patendi- taotluse siseriiklikku menetlusse esitamise kuupäev: 25.08.2003	(72) Leiutise autor: Marc H. Schneider 999 Clements Drive, Fredricton, New Brunswick E3A 7J3, CA
(86) Rahvusvahelise patendi- taotluse number: PCT/NO02/00043	(74) Patendivolinik: Tõnu Nelsas AAA Patendibüroo OÜ Tartu mnt 16, 10117 Tallinn, EE
(86) Rahvusvahelise patendi- taotluse esitamise kuupäev: 01.02.2002	
(30) Prioriteediandmed: 01.02.2001 NO 20010558	
(24) Patendi kehtivuse alguse kuupäev: 01.02.2002	
(43) Patenditaotluse avaldamise kuupäev: 15.10.2003	
(45) Patendikirjelduse avaldamise kuupäev: 15.02.2010	

(54) **Furaanpolümeeriga immutatud puit**

(57) Leiutises kirjeldatakse furaanpolümeeriga immutatud puitu, mis kujutab enesest puitu, mis on immutatud polümeriseeruva furfuroolalkoholi monomeeri lahusega, mis sisaldab eneses vähemalt vett, stabilisaatoreid ja furfuroolalkoholi ning vähemalt veel ühte ühendit, mis on valitud rühma hulgast, mis koosneb anhüdriididest, hapetest ja nende kombinatsioonidest. Samuti kirjeldatakse meetodit furaanpolümeeriga immutatud puidu valmistamiseks ja kasutamiseks.

(57) A furan polymer impregnated wood which comprises wood impregnated with a polymerizable furfural alcohol monomer solution containing at least water, stabilizers, and furfuryl alcohol, and at least one further compound selected from the group consisting of anhydrides, acids and combinations thereof is described. A method for preparing a furan polymer impregnated wood and uses thereof is also described.

EE 05266 B1

EE 05267 B1

(11) **EE 05267 B1**

(51) Int.Cl.
C07C 311/21 (2009.01)
C07C 311/29 (2009.01)
C07C 311/08 (2009.01)
C07C 311/44 (2009.01)
C07D 213/40 (2009.01)
C07D 213/64 (2009.01)
C07D 233/64 (2009.01)
C07D 235/14 (2009.01)
C07D 307/52 (2009.01)
C07D 277/28 (2009.01)
C07D 215/12 (2009.01)
A61K 31/18 (2009.01)

(12) **PATENDIKIRJELDUS**

(21) Patenditaotluse number: **P200300529**

(85) Rahvusvahelise patendi-
taotluse siseriiklikku
menetluse esitamise
kuupäev: **26.11.2003**

(86) Rahvusvahelise patendi-
taotluse number: **PCT/EP02/04138**

(86) Rahvusvahelise patendi-
taotluse esitamise kuupäev: **13.04.2002**

(30) Prioriteediandmed: **28.04.2001**
DE 10121003.5

(24) Patendi kehtivuse
alguse kuupäev: **13.04.2002**

(43) Patenditaotluse
avaldamise kuupäev: **16.02.2004**

(45) Patendikirjelduse
avaldamise kuupäev: **15.02.2010**

(73) Patendiomanik:

Sanofi-Aventis Deutschland GmbH
Brüningstrasse 50,
D-65929 Frankfurt am Main, DE

(72) Leiutise autorid:

Autorite andmed lisalehel

(74) Patendivolinik:

Harald Tehver
Patendibüroo Turvaja OÜ
Liivalaia 22, 10118 Tallinn, EE

(54) **Antraniilhappe amiidid, nende kasutamine ja farmatseutiline preparaat**

(57) Leiutis käsitleb antraniilhappe amiide, nende valmistamis-meetodit, nende kasutamist ravimina ning neid antraniilhappe amiide sisaldavaid farmatseutilisi preparaate. Antraniilhappe amiidideks on ühendid valemiga (I), milles R(1) kuni R(7) on määratletud nõudluspunktides. Nad toimivad nn Kv1.5 kaaliumi-kanalile ja pärsivad kaaliumivoolu, mida kirjeldatakse kui "ülkiirelt aktiveeruvat viitega alaldit" inimese südamekojas. Need ühendid on seetõttu iseäranis sobilikud uute arütmiaavastaste toimeainetena, eriti kodade rütmihäirete, näiteks kodade virvenduse (AF) või kodade laperduse ravil ja ennetamisel.

(57) The invention relates to anthranilic acid amides, to a method for the production thereof, to their use as a medicament, and to pharmaceutical preparations containing these anthranilic acid amides. The anthranilic acid amides consist of compounds of formula (I) in which R(1) to (R7) have the meanings as cited in the claims, act upon the Kv1.5 potassium channel, and inhibit a potassium stream described as an "ultra-rapidly activating delayed rectifier" in the human cardiac atrium. The compounds are therefore especially suited as novel antiarrhythmic active substances, particularly for treating and preventing atrial arrhythmias, e.g. atrial fibrillation AF or atrial flutter.

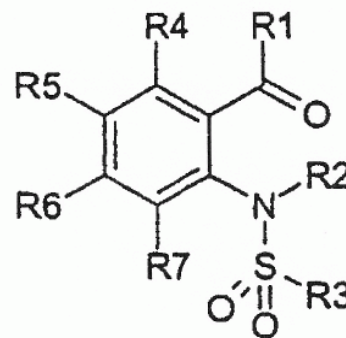

(I)

EE 05267 B1

EE 05267 B1

(72) Leiutise autorid:

Joachim Brendel
Landgrabenstrasse 23, 61118 Bad Vilbel, DE

Bernard Pirard
Eckenheimer Landstrasse 39, 60318 Frankfurt, DE

Stefan Peukert
Heiligkreuzgasse 9a, 60313 Frankfurt, DE

Heinz-Werner Kleemann
Mainstrasse 29, 65474 Bischofsheim, DE

Horst Hemmerle
8681 Jaffa Court E. Drive, Apt. #22, Indianapolis, IN 46240, US

EE 05268 B1

(19)  EESTI VABARIIK
PATENDIAMET(11) **EE 05268 B1**(51) Int.Cl.
C07D 209/42 (2009.01)
A61K 31/475 (2009.01)
A61K 31/404 (2009.01)
A61P 9/12 (2009.01)(12) **PATENDIKIRJELDUS**(21) Patenditaotluse number: **P200300001**(85) Rahvusvahelise patendi-
taotluse siseriiklikku
menetluse esitamise
kuupäev: **03.01.2003**(86) Rahvusvahelise patendi-
taotluse number: **PCT/FR01/02167**(86) Rahvusvahelise patendi-
taotluse esitamise kuupäev: **06.07.2001**(30) Prioriteediandmed: **06.07.2000**
FR 00/08793(24) Patendi kehtivuse
alguse kuupäev: **06.07.2001**(43) Patenditaotluse
avaldamise kuupäev: **16.08.2004**(45) Patendikirjelduse
avaldamise kuupäev: **15.02.2010**

(73) Patendiomanik:

Les Laboratoires Servier
12, place de la Défense,
92415 Courbevoie Cedex, FR

(72) Leiutise autorid:

Bruno Pfeiffer
47, rue Ernest Renan,
F-95320 Saint Leu la Forêt, FR**Yves-Michel Ginot**
8, quai Saint Laurent,
F-45000 Orléans, FR**Gérard Coquerel**
192, rue de l'Eglise,
F-76520 Boos, FR**Stéphane Beilles**
35, place de la Basse, Vieille Tour,
F-76000 Rouen, FR

(74) Patendivolinik:

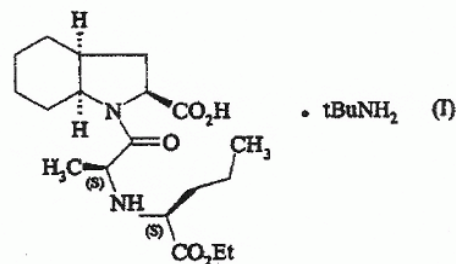
Juhan Hämmalov
OÜ Intels
Riia 11-3, 51010 Tartu, EE(54) **Perindopriili tert-butüülamiinsoola kristalliline α -vorm, selle valmistamisprotsess ja seda sisaldavad farmatseutilised kompositsioonid**(57) Valemile (I) perindopriili tert-butüülamiinsoola kristalliline α -vorm, mida iseloomustab selle pulber-röntgendifraktsiooni-diagramm. Ravimid.(57) The invention concerns α crystalline form of perindopril tert-butylamine salt of formula (I), characterised by its X-ray diffraction pattern on powder. The invention is useful for preparing medicines.

EE 05268 B1

EE 05269 B1

(11) **EE 05269 B1**

(51) Int.Cl.
C07D 239/94 (2009.01)
C07D 405/12 (2009.01)
C07D 413/12 (2009.01)
C07D 413/14 (2009.01)
A61K 31/517 (2009.01)
A61P 35/00 (2009.01)

(12) **PATENDIKIRJELDUS**

(21) Patenditaotluse number: P200300077	(73) Patendiomanik: Boehringer Ingelheim Pharma GmbH & Co. KG Binger Strasse 173, 55216 Ingelheim am Rhein, DE
(85) Rahvusvahelise patendi- taotluse siseriiklikku menetluse esitamise kuupäev: 25.02.2003	(72) Leiutise autorid: Frank Himmelsbach Ahornweg 16, 88441 Mittelbiberach, DE Elke Langkopf Schloss 3, 88447 Warthausen, DE Birgit Jung Muehlstrasse 23, 55270 Schwabenheim, DE Stefan Blech Müllerweg 9, 88447 Warthausen, DE Flavio Solca Fimbingergasse 1/9, A-1230 Wien, AT
(86) Rahvusvahelise patendi- taotluse number: PCT/EP01/09532	
(86) Rahvusvahelise patendi- taotluse esitamise kuupäev: 18.08.2001	
(30) Prioriteediandmed: 26.08.2000 DE 10042058.3	
(24) Patendi kehtivuse alguse kuupäev: 18.08.2001	
(43) Patenditaotluse avaldamise kuupäev: 15.12.2004	
(45) Patendikirjelduse avaldamise kuupäev: 15.02.2010	(74) Patendivolinik: Ljubov Kesselman OÜ Kesna Tedre 77-52, 10616 Tallinn, EE

(54) **Bitsüklilised heterotsüklilised ühendid, neid ühendeid sisaldavad ravimid, nende kasutamine ja meetodid nende valmistamiseks**

(57) Käesolev leiutis käsitleb bitsüklilisi heterotsüklilisi ühendeid üldvalemiga (I), milles R_a kuni R_c vastavad nõudluspunktides 1 kuni 7 defineeritud, nende tautomeere, stereoisomeere ja nende sooli, eriti nende füsioloogiliselt sobivaid sooli anorgaaniliste või orgaaniliste hapete või alustega, millel on väärtuslikke farmakoloogilisi omadusi, nimelt inhibeeriv toime türosiinkinaaside poolt vahendatavale signaaliülekandele, ning nende kasutamist haiguste ravimisel, eriti kasvaja, kopsuhaiguste ja hingamisteede haiguste ravimisel, ja nende ühendite valmistamise meetodit.

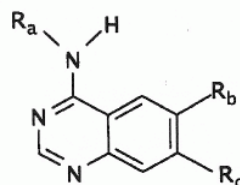

(I)

(57) The invention relates to bicyclic heterocycles of general formula (I), in which R_a to R_c are defined as referred to in Claims Nos. 1 to 7, to their tautomers, their stereoisomers, and to their salts, particularly their physiologically compatible salts with inorganic or organic acids or bases, which have valuable pharmacological properties, in particular, an inhibitive effect on the signal transduction imparted by tyrosine kinases. The invention also relates to the use of said bicyclic heterocycles for treating diseases, especially tumor diseases, disorders of the lung and of the respiratory tract, and to the production thereof.

EE 05269 B1

EE 05270 B1

(11) **EE 05270 B1**

(51) Int.Cl.
C07D 405/06 (2009.01)
C07D 207/34 (2009.01)

(12) **PATENDIKIRJELDUS**

(21) Patenditaotluse number: P200300333	(73) Patendiomanik: Lek Pharmaceuticals d.d. Verovškova 57, 1526 Ljubljana, SI
(85) Rahvusvahelise patenditaotluse siseriiklikku menetlusse esitamise kuupäev: 14.08.2003	(72) Leiutise autor: Gorazd Sorsak Lackova 5, 2325 Kidricevo, SI
(86) Rahvusvahelise patenditaotluse number: PCT/IB02/00161	(74) Patendivolinik: Jüri Käosaar Patendibüroo Käosaar & Co OÜ Tähe 94, 50107 Tartu, EE
(86) Rahvusvahelise patenditaotluse esitamise kuupäev: 22.01.2002	
(30) Prioriteediandmed: 23.01.2001 SI P-01100010	
(24) Patendi kehtivuse alguse kuupäev: 22.01.2002	
(43) Patenditaotluse avaldamise kuupäev: 15.10.2003	
(45) Patendikirjelduse avaldamise kuupäev: 15.02.2010	

(54) **Mittekristallilise kaltsiumatorvastatiini valmistamismeetod**

(57) Kaltsiumatorvastatiin, aine, mida tuntakse keemilise nimetuse [(R-(R*,R*))]-2-(4-fluorofenüül)-b,d-dihüdroksü-5-(1-metüületüül)-3-fenüül-4-[(fenüülamino)karbonüül]-1H-pürrool-1-heptaanhappe hemikaltsiumisoola järgi, on tuntud kui HMG-CoA reduktaasiinhibiitor ning seda kasutatakse antihüperkolesteroleemilise ainenä. Atorvastatiini valmistatakse tavaliselt selle kaltsiumisoolana, kuna see võimaldab atorvastatiini mugavalt farmatseutiliste retseptuuride, näiteks tablettide, kapslite, pulbrite ja muude taoliste suu kaudu manustamiseks mõeldud preparaate koosseisu lülitada. Kaltsiumatorvastatiin võib eksisteerida amorfsetel kujul või ühel kristallilistest vormidest (vorm I, II, III ja IV). Kaltsiumatorvastatiin on aine, mis on väga nõrgalt vees lahustuv, ning on leitud, et kristallilised vormid on vähem lahustuvad kui amorfne vorm, mis võib tekitada probleeme atorvastatiini bioloogilise omastatavusega organismis. Käesolev leiutus käsitleb uudset meetodit, atorvastatiini sünteesi vahetühendi valemiga (I) või atorvastatiinlaktosi muundamist mittekristalliliseks kaltsiumatorvastatiiniks, milles A tähistab ühte tavapärasid kaitserühma või eraldi kaitserühmasid dihydroksürühmale ning B tähistab ühte karboksüülhappe kaitserühma.

(57) Atorvastatin calcium, the substance known by the chemical name [(R-(R*,R*))]-2-(4-fluorophenyl)-b,d-dihydroxy-5-(1-methylethyl)-3-phenyl-4-[(phenylamino)carbonyl]-1H-pyrrole-1-heptanoic acid hemi calcium salt is known as HMG-CoA reductase inhibitor and is used as an antihypercholesterolemic agent. Atorvastatin is usually prepared as its calcium salt since it enable atorvastatin to be conveniently formulated in the pharmaceutical formulations, for example, in tablets, capsules, powders and the like for oral administration. Atorvastatin calcium can exist in an amorphous form or in one of the crystalline forms (Form I, Form II, Form III and Form IV). Atorvastating calcium is the substance which is very slightly water-soluble, and it has been found that the crystalline forms are less readily soluble than the amorphous form which may cause problems in the bioavailability of atorvastatin in the body. The present invention relates to a novel process for converting the intermediate in the synthesis of atorvastatin having the following formula (I) or atorvastatin lactose into the non-crystalline atorvastatin calcium: wherein A denotes a common protection group or separate protection groups for the dihydroxy group and B denotes a carboxylic acid protection group.

EE 05270 B1

EE 05271 B1

(11) **EE 05271 B1**

(51) Int.Cl.
C07D 471/04 (2009.01)
A61P 11/00 (2009.01)
A61K 31/40 (2009.01)
A61K 31/444 (2009.01)

(12) **PATENDIKIRJELDUS**

(21) Patenditaotluse number: P200300166	(73) Patendiomanik: Elbion AG Meissner Strasse 191, 01445 Radebeul, DE
(85) Rahvusvahelise patendi- taotluse siseriiklikku menetlusse esitamise kuupäev: 25.04.2003	(72) Leiutise autorid: Norbert Höfgen Hufenweg 1, 01458 Ottendorf-Okrilla, DE
(86) Rahvusvahelise patendi- taotluse number: PCT/EP01/12376	Ute Egerland Magdalenenstrasse 1, 01445 Radebeul, DE
(86) Rahvusvahelise patendi- taotluse esitamise kuupäev: 25.10.2001	Thomas Kronbach Elbstrasse 3b, 01445 Radebeul, DE
(30) Prioriteediandmed: 27.10.2000 DE 10053275.6	Degenhard Marx Fichtenstrasse 6, 78315 Radolfzell, DE
	Stefan Szelenyi Händelstrasse 32, 90571 Schwaig, DE
(24) Patendi kehtivuse alguse kuupäev: 25.10.2001	Hildegard Kuss Kieler Strasse 6, 01109 Dresden, DE
(43) Patenditaotluse avaldamise kuupäev: 15.08.2003	Emmanuel Polymeropoulos Beethovenstrasse 60, 60325 Frankfurt am Main, DE
(45) Patendikirjelduse avaldamise kuupäev: 15.02.2010	(74) Patendivolinik: Arvo Salumäe OÜ Amende Patendibüroo J. Köleri 8, 10150 Tallinn, EE

(54) **7-asaindoolid, meetod nende sünteesimiseks, nende kasutamine TNF α või fosfodiesteras-4 inhibeerivate ravimite valmistamiseks ning neid sisaldavad ravimid**

(57) Leiutis käsitleb asendatud 7-asaindooli üldvalemiga 1, meetodeid nende sünteesimiseks ning neid sisaldavaid ravimipreparaate, mis leiavad kasutust fosfodiesteras-4 inhibiitoritena.

(57) The invention relates to 7-azaindoles, the use thereof as phosphodiesterase 4 inhibitors and a method for producing the same.

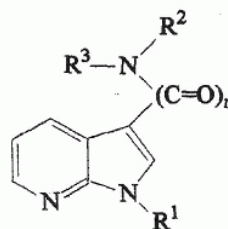
**1****EE 05271 B1**

EE 05272 B1

(11) **EE 05272 B1**

(51) Int.Cl.
C07D 471/04 (2009.01)
A61K 31/55 (2009.01)
A61P 9/04 (2009.01)

(12) **PATENDIKIRJELDUS**

(21) Patenditaotluse number: P200300500	(73) Patendiomanik: Sanofi-Aventis Deutschland GmbH Brüningstrasse 50, D-65929 Frankfurt am Main, DE
(85) Rahvusvahelise patendi- taotluse siseriiklikku menetluse esitamise kuupäev: 11.11.2003	(72) Leiutise autorid: Gary A. Flynn 9750 N. Cliff View Place, Tucson, AZ 85737, US
(86) Rahvusvahelise patendi- taotluse number: PCT/EP02/03668	Shujaath Mehdi 43 N. 14th Avenue, Appartment 2, Manville, NJ 08835, US
(86) Rahvusvahelise patendi- taotluse esitamise kuupäev: 03.04.2002	Jack Roger Koehl 168 Aster Court, Whitehouse Station, NJ 08889, US
(30) Prioriteediandmed: 12.04.2001 US 60/283305	Barbara Ann Anderson 239 Forestwood Drive, Cincinnati, OH 45216, US
	Manfred Gerken Lahnblick 13, 35041 Marburg, DE
(24) Patendi kehtivuse alguse kuupäev: 03.04.2002	Bernd Jablonka Im Wingert 5, 61440 Oberursel, DE
(43) Patenditaotluse avaldamise kuupäev: 15.12.2003	Heinz-Werner Kleemann Mainstrasse 29, 65474 Bischofsheim, DE
(45) Patendikirjelduse avaldamise kuupäev: 15.02.2010	Wolfgang Linz Huxelrebenweg 54, 55129 Mainz, DE
	Werner Seiz Gartenstrasse 42, 60596 Frankfurt am Main, DE
	Bernhard Seuring Frankfurter Strasse 19, 65719 Hofheim, DE
	(74) Patendivolinik: Harald Tehver Patendibüroo Turvaja OÜ Liivalaia 22, 10118 Tallinn, EE

(54) **Merkaptoatsetüülamiidi derivaadid, nende valmistamismeetod ja kasutamine**

(57) Leiutis käsitleb teatud tüüpi merkaptoatsetüülamiidi derivaate. Kirjeldatakse ka neid ühendeid sisaldavaid farmatseutilisi kompositsioone ning nende ühendite valmistamismeetodeid. Samuti kirjeldatakse nende ühendite kasutamist ravimi valmistamiseks kardiovaskulaarse haiguseisundi raviks.

(57) The invention discloses a series of mercaptoacetylamine derivatives. Also disclosed are pharmaceutical compositions incorporating these compounds and processes for preparing said compounds. The use of said compounds for inhibition of the preparatiuon of a medicament for treating a cardiovascular disease condition is also disclosed.

EE 05272 B1

EE 05273 B1

(11) **EE 05273 B1**

(51) Int.Cl.
C07D 491/04 (2009.01)
C07D 491/044 (2009.01)
A61K 31/425 (2009.01)
A61P 35/00 (2009.01)

(12) **PATENDIKIRJELDUS**

(21) Patenditaotluse number: P200300063	(73) Patendiomanik: Bristol-Myers Squibb Company Lawrenceville-Princeton Road, Princeton, NJ 08543-4000, US
(85) Rahvusvahelise patendi- taotluse siseriiklikku menetlusse esitamise kuupäev: 13.02.2003	(72) Leiutise autorid: Autorite andmed lisalehel
(86) Rahvusvahelise patendi- taotluse number: PCT/US01/24540	(74) Patendivolinik: Jüri Käosaar Patendibüroo Käosaar & Co OÜ Tähe 94, 50107 Tartu, EE
(86) Rahvusvahelise patendi- taotluse esitamise kuupäev: 01.08.2001	
(30) Prioriteediandmed: 16.08.2000 US 60/225590	
(24) Patendi kehtivuse alguse kuupäev: 01.08.2001	
(43) Patenditaotluse avaldamise kuupäev: 15.12.2004	
(45) Patendikirjelduse avaldamise kuupäev: 15.02.2010	

(54) **Epotilooni analoogi polümorfid, meetod nende saamiseks ning kasutamine**

(57) Leiutises esitatakse epotilooni analoogi valemiga I kaks kristalset polümorfi, mida tähistatakse vastavalt kui vorm A ja vorm B, samuti esitatakse meetodid uute polümorfide moodustamiseks, nende plümorfide kasutamine ravimi valmistamiseks vähi või teiste proliferatiivsete haiguste raviks ja neid sisaldavad ravimkoostised.

(57) There are provided in accordance with the present invention two crystalline polymorphs, designated Form A and Form B, respectively, as well as mixtures thereof, of an epothilone analog represented by the formula I. Also provided are methods of forming the novel polymorphs, their use for the manufacture of a medicament for treating cancer or other proliferative diseases and pharmaceutical compositions containing them.

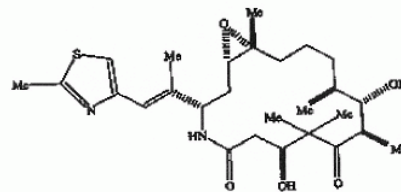

I

EE 05273 B1

EE 05273 B1

(72) Leiutise autorid:

John D. Dimarco
16 Neal Drive, East Brunswick, NJ 08816, US

Jack Z. Gougoutas
101 Westerly Road, Princeton, NJ 08540, US

Imre M. Vitez
117 Main Street,
Whitehouse Station, NJ 08889, US

Martha Davidovich
159 Fern Road,
East Brunswick, NJ 08816, US

Michael Galella
3 Evergreen Court, Belle Mead, NJ 08502, US

Timothy M. Malloy
1902 Makefield Road, Yardley, PA 19067, US

Zhenrong Guo
21 Augusta Place,
East Brunswick, NJ 08816, US

Denis Favreau
5065 Terrasse Beaudry, Saint-Hubert, Quebec J3Y 6L2, CA

EE 05274 B1



(19) **EESTI VABARIIK**
PATENDIAMET



(11) **EE 05274 B1**

(51) Int.Cl.
C07J 1/00 (2009.01)
A61K 31/565 (2009.01)
A61P 5/26 (2009.01)

(12) **PATENDIKIRJELDUS**

(21) Patenditaotluse number: P200300346	(73) Patendiomanik: Schering Aktiengesellschaft Müllerstrasse 178, 13353 Berlin, DE
(85) Rahvusvahelise patendi- taotluse siseriiklikku menetlusse esitamise kuupäev: 22.08.2003	(72) Leiutise autorid: Rolf Bohlmann Kühler Weg 6a, 14055 Berlin, DE
(86) Rahvusvahelise patendi- taotluse number: PCT/EP02/00722	Hermann Künzer Turiner Str. 4, 13347 Berlin, DE
(86) Rahvusvahelise patendi- taotluse esitamise kuupäev: 24.01.2002	Reinhard Nubbemeyer Am Springbruch 11, 13469 Berlin, DE
(30) Prioriteediandmed: 24.01.2001 DE 10104327.9	Dieter Zopf Neuwerker Weg 15A, 14167 Berlin, DE
(24) Patendi kehtivuse alguse kuupäev: 24.01.2002	(74) Patendivolinik: Jaak Ostrat OÜ Lasvet Suurtüki 4a, 10133 Tallinn, EE
(43) Patenditaotluse avaldamise kuupäev: 15.12.2003	
(45) Patendikirjelduse avaldamise kuupäev: 15.02.2010	

(54) **Androgeensed 7-asendatud 11-halogenosteroidid ja neid sisaldavad farmatseutilised kompositsioonid**

(57) Leiutis käsitleb 11 β -halogenosteroidide üldvalemiga I, milles R¹¹ on halogeeniaatom, X-Y-Z on üks kahest rühmast struktuuriga CH=C-C või CH₂-C=C ja teised asendajad on tähendustega, mis on näidatud nõudluspunktides, samuti nende ühendite valmistamist ja kasutamist farmatseutiliste ainete ning 11 β -halogenosteroidide sisaldavate farmatseutiliste preparaate valmistamiseks.

(57) The invention relates to 11 β -halogen steroids with general formula I, whereby R¹¹ is halogen, X-Y-Z represents a group with one of the two structures CH=C-C or CH₂-C=C and the other radicals have the meaning that is indicated in the claims, also the production and use of these compounds for the production of pharmaceutical agents as well as pharmaceutical preparations that contain 11 β -halogen steroids.

EE 05274 B1

EE 05275 B1

(11) **EE 05275 B1**

(51) Int.Cl.
C09D 5/16 (2009.01)
C09D 171/00 (2009.01)
C09D 183/04 (2009.01)
C09D 183/10 (2009.01)
C09D 201/04 (2009.01)

(12) **PATENDIKIRJELDUS**

(21) Patenditaotluse number: P200300401	(73) Patendiomanik: Akzo Nobel N.V. Velperweg 76, NL-6824 BM Arnhem, NL
(85) Rahvusvahelise patendi- taotluse siseriiklikku menetlusse esitamise kuupäev: 19.09.2003	(72) Leiutise autorid: David Neil Williams 22A Woolsington Gardens, Woolsington, Newcastle upon Tyne NE13 8AR, GB
(86) Rahvusvahelise patendi- taotluse number: PCT/EP02/03046	Nigel Ivor Edward Shewring 24 Albemarle Avenue, High West Jesmond, Newcastle upon Tyne NE2 3NQ, GB
(86) Rahvusvahelise patendi- taotluse esitamise kuupäev: 18.03.2002	Adrian James Lee 12 Wiseton Court, South Gosforth, Newcastle upon Tyne NE7 7NT, GB
(30) Prioriteediandmed: 21.03.2001 EP 01201071.6	(74) Patendivolinik: Lembit Mitt AAA Patendibüroo OÜ Tartu mnt 16, 10117 Tallinn, EE
(24) Patendi kehtivuse alguse kuupäev: 18.03.2002	
(43) Patenditaotluse avaldamise kuupäev: 15.12.2003	
(45) Patendikirjelduse avaldamise kuupäev: 15.02.2010	

(54) Reostusvastased kompositsioonid fluoritud alküül- või alkoksürühma sisaldava polümeeri või oligomeeriga

(57) Leiutis käsitleb reostusvastast kompositsiooni, mis sisaldab kõvenevat või ristseotud polümeeri, mis on vaba perfluorpolüeteeri osadest, ning vedelikku, mis on fluoritud alküül- või alkoksürühma sisaldava polümeeri või oligomeeriga. Eelistatavalt sisaldab fluoritud alküül- või alkoksürühma sisaldav polümeer või oligomeer korduvat ühikut üldvalemi $-[\text{CFR}-(\text{CFR})_m-(\text{O})_n-\text{[CFR-O]}_q]-$ järgi, milles n on 0 või 1, m on täisarv alates 0 kuni 4, R on sõltumatult H, F, Cl, Br, või CF_3 , ja suhe q/p on 0-10, ning fluorivaba polümeer on organosiloksaani sisaldav polümeer, mis sisaldab korduvat ühikut üldstruktuuri $-\text{[SiR}_1\text{R}_2\text{-O]}-$ järgi, milles R_1 ja R_2 on sõltumatult valitud vesiniku, alküüli, aralküüli ja vinüülrühma hulgast.

(57) The invention pertains to an anti-fouling composition which comprises a cured or cross-linked polymer free of perfluoropolyether moieties and a fluid fluorinated alkyl- or alkoxy-containing polymer or oligomer. Preferably, the fluorinated alkyl- or alkoxy-containing polymer or oligomer comprises a repeating unit of the general formula: $-[\text{CFR}-(\text{CFR})_m-(\text{O})_n-\text{[CFR-O]}_q]-$ wherein n is 0 or 1, m is an integer from 0 to 4, R independently is H, F, Cl, Br, or CF_3 , and the ratio q/p is 0 - 10, and the fluorine-free polymer is an organosiloxane-containing polymer comprising a repeating unit of the general structure $-\text{[SiR}_1\text{R}_2\text{-O]}-$, wherein R_1 and R_2 are independently selected from hydrogen, alkyl, aryl, aralkyl, and a vinyl group.

EE 05275 B1

EE 05276 B1(19)  **EESTI VABARIIK**
PATENDIAMET(11) **EE 05276 B1**(51) Int.Cl.
C12N 15/28 (2009.01)
C07K 14/525 (2009.01)
C07K 16/24 (2009.01)
C12N 15/11 (2009.01)
A61K 48/00 (2009.01)
C12N 5/10 (2009.01)
A61K 39/395 (2009.01)
A61K 38/19 (2009.01)
C07K 14/705 (2009.01)
A61P 35/00 (2009.01)
A61P 37/00 (2009.01)(12) **PATENDIKIRJELDUS**

(21) Patenditaotluse number: **P199900043**

(85) Rahvusvahelise patendi-
taotluse siseriiklikku
menetluse esitamise
kuupäev: **05.02.1999**

(86) Rahvusvahelise patendi-
taotluse number: **PCT/US97/13945**

(86) Rahvusvahelise patendi-
taotluse esitamise kuupäev: **07.08.1997**

(30) Prioriteediandmed: **07.08.1996**
US 60/023541
18.10.1996
US 60/028515
18.03.1997
US 60/040820

(24) Patendi kehtivuse
alguse kuupäev: **07.08.1997**

(43) Patenditaotluse
avaldamise kuupäev: **16.08.1999**

(45) Patendikirjelduse
avaldamise kuupäev: **15.02.2010**

(73) Patendiomanikud:

Biogen Idec MA Inc.
14 Cambridge Center,
Cambridge, MA 02142, US**The Faculty of medicine**
of the University of Geneva
1, rue Michel Servet, CH-1211 Geneva 4, CH

(72) Leiutise autorid:

Yves Chicheportiche
8, chemin de la fontaine,
CH-1224 Chêne-Bougeries, CH**Jeffrey L. Browning**
32 Milton Road, Brookline, MA 02146, US

(74) Patendivolinik:

Lembit Mitt
AAA Patendibüroo OÜ
Tartu mnt 16, 10117 Tallinn, EE**(54) Kasvaja nekroosifaktori sugulasligand**

(57) Kasvaja nekroosifaktori sugulasligand (Tumor Necrosis Factor Related Ligand, TRELL), uus kasvaja nekroosifaktori (TNF) perekonna liige, modifitseeritud TRELL ja neid sisaldavad farmatseutilised kompositsioonid.

(57) Tumor necrosis factor related ligand (TRELL), a novel member of the tumor necrosis factor family (TNF), modified TRELL, and pharmaceutical compositions comprising them.

EE 05276 B1

EE 05277 B1

(11) **EE 05277 B1**

(51) Int.Cl.
D21H 17/66 (2009.01)
A61L 15/18 (2009.01)
A61L 15/28 (2009.01)
D21C 9/00 (2009.01)

(12) **PATENDIKIRJELDUS**(21) Patenditaotluse number: **P199900520**

(85) Rahvusvahelise patendi-
taotluse siseriiklikku
menetlusse esitamise
kuupäev: **06.11.1999**

(86) Rahvusvahelise patendi-
taotluse number: **PCT/SE98/00585**

(86) Rahvusvahelise patendi-
taotluse esitamise kuupäev: **30.03.1998**

(30) Prioriteediandmed: **07.05.1997**
SE 9701711-5

(24) Patendi kehtivuse
alguse kuupäev: **30.03.1998**

(43) Patenditaotluse
avaldamise kuupäev: **15.06.2000**

(45) Patendikirjelduse
avaldamise kuupäev: **15.02.2010**

(73) Patendiomanik:

Stora Enso Aktiebolag
Åsgatan 22, SE-791 80 Falun, SE

(72) Leiutise autor:

Leif Norlander
Länsmansvägen 7, S-791 61 Falun, SE

(74) Patendivolinik:

Toom Pungas
OÜ Synest
pk 977, 13402 Tallinn, EE

(54) **Tselluloosipulbi valmistamise meetod, tselluloosipulbi kasutamine imavates toodetes ning imav toode**

(57) Leiutis on seotud tselluloosipulbi valmistamise meetodiga, kus tselluloosipulp peaks olema ebemeline, tootmaks imavates toodetes sisalduvaid imavaid materjale. Eristavateks iseloomustavateks tunnusteks on vähemalt mõne vees lahustuva mittepolümeerse alumiiniumsoola lisamine tselluloosikiududele vesilahuses, et moodustada sellisest fiibri pulbist võrk, mis oleks veetustatud ja kuivatatud ning mille niiskussisaldus oleks reguleeritud suuremaks kui 8%, aga mitte rohkem kui 20% vahetult enne kiustamist. Leiutis on seotud ka tselluloosipulbiga, mis sobib ebemeliseks muutmiseks, ning samuti ebemeliseks tehtud tselluloosipulbiga ja sellest valmistatud imavate toodetega.

(57) The invention relates to a method for the preparation of a cellulose pulp adapted to be defibrated (fluffed) for production of absorbent material intended to be included as a constituent in absorbent products. The distinguishing features are that at least some non polymeric aluminium salt, which is water soluble, is added to a stock of cellulose fibres in a water suspension, that this fibre pulp is formed to a web which is dewatered and dried, and that its moisture content is adjusted to more than 8 % but not more than 20 % at the latest before defibration. The invention also relates to cellulose pulp which is adapted to be defibrated as well as to the defibrated cellulose pulp and absorption products produced therefrom.

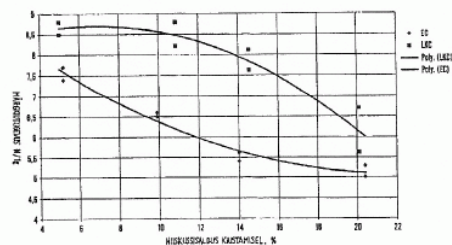

EE 05277 B1

EE 05278 B1

(11) **EE 05278 B1**

(51) Int.Cl.
G01N 21/84 (2009.01)
C10L 1/00 (2009.01)

(12) **PATENDIKIRJELDUS**

(21) Patenditaotluse number: P200400072	(73) Patendiomanik: AS Laser Diagnostic Instruments Kadaka tee 113A, 12915 Tallinn, EE
(22) Patenditaotluse esitamise kuupäev: 23.03.2004	(72) Leiutise autorid: Sergei Babitšenko Kuslapuu 9, 12012 Tallinn, EE
(24) Patendi kehtivuse alguse kuupäev: 23.03.2004	Alexander Dudelzak 48 Sheahan Crescent, Nepean, Ontario K2H 8M2, CA
(43) Patenditaotluse avaldamise kuupäev: 15.12.2005	Larissa Porõvkina Trummi põik 15a-25, 12616 Tallinn, EE
(45) Patendikirjelduse avaldamise kuupäev: 15.02.2010	(74) Patendivolinik: Andres Mutt OÜ Lasvet Suurtüki 4a, 10133 Tallinn, EE

(54) **Meetod vedelike automaatseks krüpteerimisega markeerimiseks ja järgnevaks identifitseerimiseks**

(57) Leiutises on välja pakutud meetod vedelike automaatseks krüpteerimisega markeerimiseks ja seda meetodit kasutades markeeritud vedelike identifitseerimiseks. Markeerimiseks valitakse teatud arv markereid ja iga markeri jaoks genereeritakse juhuslik arv, mis määrab markeri koguse. Markerite arvu, nende mõõdetud kontsentratsiooni ja kontsentratsioonide suhte põhjal markeeritavas vedelikus moodustatakse spetsiifiline, ainult seda vedelikku identifitseeriv markeerimiskood. Markeerimiskood krüpteeritakse ja edastatakse toote volitatud kasutajale (ametlikule tellijale). Saadud krüpteeritud markeerimiskoodis dekrüpteeritakse ja selles sisalduvaid markerite parameetreid võrreldakse vedelikus tegelikult sisalduvate markerite kohapeal kindlaksmääratud parameetritega, ja nende andmete võrdlemisel vedelik identifitseeritakse. Identifitseerimine toimub automaatselt reaajas ilma vajaduseta teostada seni kohustuslikuks olnud laboratoorseid analüüse, tagades inimfaktori täieliku välistamise nii markeerimis- kui ka identifitseerimisprotsessides. Sellega suureneb oluliselt vedelike markeerimise turvalisus.

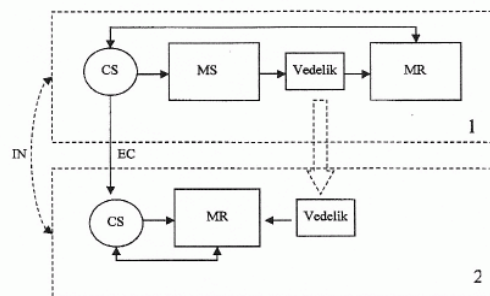

(57) The invention provides a method for automatic encrypted marking of liquids and for identifying liquids marked by using this method. For marking a certain number of markers is selected and for every marker a random number is generated, the value of which defines the amount of a marker. Based on the number of markers, their measured concentrations and the relation of markers concentrations in the marked liquid a specific marking code is compiled, characteristic only for this liquid. The marking code is encrypted and delivered to an authorized user (official purchaser). The encrypted marking code is decrypted and for identifying of the liquid the original parameters contained in the marking code are compared with parameters actually measured on site. This identification is carried out automatically in real time without any need for laboratory analyses, thus practically excluding human factor in both the marking and identification processes. By using the proposed method the security level of marking liquids is remarkably improved.

EE 05278 B1

EE 05279 B1

(11) **EE 05279 B1**

(51) Int.Cl.
G06Q 50/00 (2009.01)
G06Q 30/00 (2009.01)

(12) **PATENDIKIRJELDUS**

(21) Patenditaotluse number: **P200700023**

(85) Rahvusvahelise patenditaotluse siseriiklikku menetlusse esitamise kuupäev: **14.05.2007**

(86) Rahvusvahelise patenditaotluse number: **PCT/MX2005/000088**

(86) Rahvusvahelise patenditaotluse esitamise kuupäev: **30.09.2005**

(30) Prioriteediandmed: **12.10.2004**
MX PA/a/2004/010077

(24) Patendi kehtivuse alguse kuupäev: **30.09.2005**

(43) Patenditaotluse avaldamise kuupäev: **15.08.2007**

(45) Patendikirjelduse avaldamise kuupäev: **15.02.2010**

(73) Patendiomanik:

Iusa S.A. de C.V.
KM 109, Carretera Panamericana,
México-Querétano, C.P. 50700 Pasteje,
Jocotitlan, MX

(72) Leiutise autor:

Eduardo Agustín Neri-Badillo
KM 109, Carretera Panamericana,
México-Querétano, C.P. 50700 Pasteje,
Jocotitlan, MX

(74) Patendivolinik:

Jüri Käosaar
Patendibüroo Käosaar & Co OÜ
Tähe 94, 50107 Tartu, EE

(54) **Elektrienergia ettemaksemeetod, meetod elektrienergia tarneks mõõteseadmesse ning ettemakse ja elektrienergia tarne juhtimise süsteem**

(57) Käesolev leiutis käsitleb sellise mõõteseadme kasutamist, mis on täielikult liidetud ühte esemisse, mis on üleni kaetud ega oma kokkupuudet väliskeskkonnaga, sisaldab ettemaksesüsteemi ja täiustatud elektrienergia tarne juhtimise süsteemi ning kogub kontaktivabade kiipkaartide abil mõõteseadmelt täielikumat teavet.

(57) The present invention refers to the use of a meter completely integrated on a single piece, totally covered and without contact with the exterior that incorporates a prepayment system and a more efficient method to control the electric energy supply and obtains excellent information from the meter by means of contactless intelligent cards.

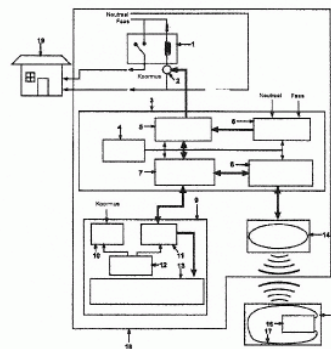

EE 05279 B1

**GB1A. AVALDATUD PATENDITAOTLUSTE ÕIGUSLIKU
STAATUSE MUUDATUSED**

Eesti Patendi- lehe number	Patenditaotluse number	Rahvusvahelise patendiklassi- fikatsiooni indeksid	Avaldatud andmed	Muudetud andmed	Kood (WIPO ST. 17)
2006, 1	P200400091	C01B 31/08	Carbon.ee OÜ Riia 185, 51014 Tartu, EE (Eesti Patendileht 2009, 1 I osa GB1A)	HLR Development OÜ Risti 12, 50303 Tartu, EE	GB1A
2006, 6	P200500009	C01B 31/02 C01B 31/00	Carbon.ee OÜ Riia 185, 51014 Tartu, EE (Eesti Patendileht 2009, 1 I osa GB1A)	HLR Development OÜ Risti 12, 50303 Tartu, EE	GB1A

HZ1A. AVALDATUD PATENDITAOTLUSTE ANDMETE PARANDUSED JA MUUDATUSED

Eesti Patendi- lehe number	Patenditaotluse number	Rahvusvahelise patendiklassi- fikatsiooni indeksid	Avaldatud andmed	Parandatud ja muudetud andmed	Kood (WIPO ST. 17)
2003, 5	P200300333	C07D 207/34 C07D 405/06	Gorazd Sorsak Lackova 5, 2325 Kidricevo, SL	Gorazd Sorsak Lackova 5, 2325 Kidricevo, SI	HK1A
2004, 1	P200300552	C07K 14/52 C07K 14/525 A61K 38/19 C12N 5/10 C12N 15/28	Hosung Min 3875 Conner Court, Newbury Park, CA 91320, US Hailing Hsu 11623 Blossomwood Moorpark, CA 93021, US	Hosung Min 3875 Conner Court, Newbury Park, CA 91320, US Hailing Hsu 11623 Blossomwood Moorpark, CA 93021, US Fei Xiong 2757 Autumn Ridge Drive, Thousand Oaks, CA 91362, US	HK1A
2008, 6	P200700016	B63B 35/79	Arno Anijalg OÜ Ustervall Kivi 21-6, 51009 Tartu, EE	Mart Enn Koppel Patendibüroo Koppel OÜ Kajaka 4-10, 11317 Tallinn, EE	HC1A HC1A HE1A
2009, 4	P200800001	B65G 33/00 B65G 33/08 B65G 33/14 B65G 33/26 B65G 33/34	Jüri Käosaar Patendibüroo Käosaar & Co OÜ, Tähe 94, 50107 Tartu, EE	Margus Sarap Sarap ja Partnerid Patendibüroo, Riia 185A, 51014 Tartu, EE	HC1A HC1A HE1A

TZ4A. REGISTREERINGU ANDMETE PARANDUSED JA MUUDATUSED

Eesti Patendi- lehe number	Patendi number	Rahvusvahelise patendiklassi- fikatsiooni indeksid	Avaldatud andmed	Parandatud ja muudetud andmed	Kood (WIPO ST. 17)
2008, 6 I osa TZ4A	02943	C08J 11/12 C10G 1/10	Jüri Käosaar Patendibüroo Käosaar & Co OÜ, Tähe 94, 50107 Tartu, EE	Margus Sarap Sarap ja Partnerid Patendibüroo, Riia 185A, 51014 Tartu, EE	TC4A TC4A TE4A
2008, 6 I osa TZ4A	04502	C10B 53/06 C10G 1/02 C10B 1/10	Jüri Käosaar Patendibüroo Käosaar & Co OÜ, Tähe 94, 50107 Tartu, EE	Margus Sarap Sarap ja Partnerid Patendibüroo, Riia 185A, 51014 Tartu, EE	TC4A TC4A TE4A

MZ4A. PATENTIDE KEHTIVUSE LÕPPEMINE

Teade avaldatakse "Patendiseaduse" § 38 lõike 2 ja § 50 lõike 5 alusel.

Eesti Patendilehe number	Patendi number	Rahvusvahelise patendiklassifikatsiooni indeksid	Patendi kehtivuse lõppemise kuupäev	Kood (WIPO ST. 17)
2000, 5	03296	A61K 31/15 A61K 31/455 C07C 259/02 C07D 213/78 C07D 295/088	04.05.2009	MM4A
2000, 6	03307	A61M 15/00	26.05.2009	MM4A
2000, 6	03309	B29C 31/04	17.05.2009	MM4A
2000, 6	03311	C07D 213/81 C07C 259/18 C07C 257/18 C07C 257/20 A61K 31/155	03.06.2009	MM4A
2001, 6	03554	B01D 15/02 B01J 20/00	27.06.2009	MM4A
2001, 6	03563	C07B 59/00 C07D 263/58 C07D 277/82 A61K 31/42 A61K 31/425 A61K 51/04	02.05.2009	MM4A
2002, 1	03646	H04M 1/02 H04R 1/30	02.05.2009	MM4A
2002, 2	03713	G02F 1/13 H01R 12/16 H01R 13/24 H05K 3/30	22.06.2009	MM4A
2002, 3	03788	H03M 13/41 H03M 13/45	12.05.2009	MM4A
2002, 6	03917	C03B 35/10	28.06.2009	MM4A
2003, 1	03978	E06C 7/00 E06C 7/08	15.06.2009	MM4A
2003, 2	04018	C07D 495/04 C07D 495/00	18.05.2009	MM4A
2003, 2	04026	E06C 7/08 E06C 9/04	15.06.2009	MM4A
2003, 2	04032	H04R 23/00	07.05.2009	MM4A
2003, 5	04140	A61K 8/11 A61K 8/34 A61K 8/58 A61K 8/92 A61Q 11/00	26.06.2009	MM4A

Eesti Patendilehe number	Patendi number	Rahvusvahelise patendiklassifikatsiooni indeksid	Patendi kehtivuse lõppemise kuupäev	Kood (WIPO ST. 17)
2003, 5	04149	C07C 323/58 A61K 31/197	27.05.2009	MM4A
2003, 5	04153	C07D 401/04 C07D 403/04 C07D 231/14 C07D 231/56 C07D 261/20 C07D 401/14 C07D 413/04 C07D 413/14 A61K 31/4709 A61K 31/422	18.06.2009	MM4A
2003, 6	04182	B60N 3/04	06.06.2009	MM4A
2004, 2	04269	B65C 9/18	24.06.2009	MM4A
2004, 3	04311	C07D 405/14 A61K 31/495 C07D 249/12	06.05.2009	MM4A
2004, 3	04320	E05C 9/00	18.05.2009	MM4A
2004, 4	04346	C07D 249/12 C07D 521/00 C07D 405/14 A61K 31/495	06.05.2009	MM4A
2004, 5	04378	C12N 15/12 C07K 14/725 C07K 16/28 A61K 38/17 A61K 39/395 G01N 33/53	03.06.2009	MM4A
2005, 1	04442	F02M 31/16 F02M 37/22 F02B 3/06	20.06.2009	MM4A
2005, 2	04478	H04B 1/40 H04B 1/48	21.05.2009	MM4A
2005, 3	04492	C07C 225/22 C07C 235/38 C07C 235/84 C07C 255/57 C07D 237/32 C07D 249/18 C07D 265/02 C07D 271/08 C07D 285/10 C07D 307/88 C07D 307/94 C07D 311/76 C07D 333/72 C07D 409/12	02.06.2009	MM4A

Eesti Patendilehe number	Patendi number	Rahvusvahelise patendiklassifikatsiooni indeksid	Patendi kehtivuse lõppemise kuupäev	Kood (WIPO ST. 17)
2006, 1	04581	A61K 38/00 A61K 39/00 A61K 31/445 C12N 15/00	19.05.2009	MM4A
2006, 1	04594	A61K 31/70 A61P 31/04 C07H 17/08	02.05.2009	MM4A
2006, 3	04638	C07C 213/02 C07C 217/12	10.05.2009	MM4A
2006, 3	04639	C07D 207/16 A61K 31/40	28.05.2009	MM4A
2006, 3	04653	H02H 1/06 H02H 3/05 H02H 3/33	11.06.2009	MM4A
2006, 5	04703	A61K 31/445 A61K 31/42 A61K 31/41 A61K 31/52	14.06.2009	MM4A
2006, 5	04704	A61K 31/496 A61K 9/10	08.05.2009	MM4A
2006, 5	04728	G01N 21/90	13.05.2009	MM4A
2007, 1	04772	A61P 3/04 A61P 3/06 A61P 3/10 A61P 9/10 A61K 31/192 A61K 31/255 C07C 217/76 C07C 309/66 C07C 309/73 C07C 317/22	31.05.2009	MM4A
2007, 2	04804	B05C 9/06 B05C 5/02 B32B 7/14 C09J 5/04	16.06.2009	MM4A
2007, 3	04845	B62D 21/02 B62D 21/18	30.05.2009	MM4A
2007, 3	04853	C07D 473/34 C07H 19/16 A61K 31/7076 A61K 31/52 A61P 3/06 A61P 3/10 A61P 9/06 A61P 9/08	21.06.2009	MM4A

Eesti Patendilehe number	Patendi number	Rahvusvahelise patendiklassifikatsiooni indeksid	Patendi kehtivuse lõppemise kuupäev	Kood (WIPO ST. 17)
2007, 6	04938	C07D 213/36 C07D 213/38 C07D 405/12 C07D 401/12 A61K 31/44 A61P 35/00	08.05.2009	MM4A
2007, 6	04941	C07D 471/04 A61K 31/4375 A61K 31/444 A61P 25/00 A61P 25/28 A61P 25/18	12.06.2009	MM4A
2008, 1	04968	E01B 7/00 E01B 29/00 E01B 29/02	07.05.2009	MM4A
2008, 2	05007	C07H 17/08 A61K 31/7048 A61P 31/04	02.05.2009	MM4A
2008, 2	05009	E21C 41/26	31.05.2009	MM4A
2008, 3	05042	G01R 29/10	13.06.2009	MM4A
2008, 3	05048	H04Q 7/36 H04Q 7/38	18.05.2009	MM4A
2008, 4	05068	C07H 17/08 A61K 31/7052 A61P 31/04 A61P 33/02	13.06.2009	MM4A
2008, 5	05097	H04N 7/173 H04N 7/16	30.06.2009	MM4A
2009, 1	05143	H01H 51/08 H01H 50/54	10.05.2009	MM4A
2009, 2	05147	A61K 9/10 A61K 9/50 A61K 31/5383 A61K 47/04 A61K 47/18 A61K 47/26 A61K 47/32 A61K 47/38	21.06.2009	MM4A

II OSA EUROOPA PATENDID

BB2A. AVALDATUD EUROOPA PATENDITAOTLUSTE PATENDINÕUDLUSE TÕLKED

Teade avaldatatakse "Euroopa patentide väljaandmise konventsiooni kohaldamise seaduse" § 20 lõige 1 punkti 2 ja majandusministri 24. juuli 2002. a määruse nr 46 "Euroopa patenditaotluse Eesti Patendiametile esitamise ja Euroopa Patendiametile edastamise, Euroopa patenditaotluse patendinõudluse ja patendikirjelduse tõlke esitamise ja avalikustamise ning Euroopa patenditaotluse siseriiklikuks patenditaotluseks ja kasuliku mudeli registreerimise taotluseks muutmise kord" § 23 lõike 1 alusel.

- (11) 0036
 - (96) 09159736.9
 - (96) 08.05.2009
 - (30) 08.05.2008, 10.07.2008, 30.11.2008, 25.02.2009
 - (51) **F16M13/02, F16M11/10**
 - (54) Kuvari tõsteseade
 - (71) Samsung Electronics Co., Ltd
416 Maetan-dong Yeongtong-gu, Suwon-si,
Gyeonggi-do 442-742, KR
 - (74) Tõnu Nelsas
AAA Patendibüroo OÜ
Tartu mnt 16, 10117 Tallinn, EE
-

FG4A. EESTIS KEHTIVATE EUROOPA PATENTIDE PATENDIKIRJELDUSE TÕLKED

Registreeringud nr E003726 kuni E003901

Teade avaldatatakse "Euroopa patentide väljaandmise konventsiooni kohaldamise seaduse" § 20 lõige 1 punkti 2 ja majandusministri 24. juuli 2002. a määruse nr 46 "Euroopa patenditaotluse Eesti Patendiametile esitamise ja Euroopa Patendiametile edastamise, Euroopa patenditaotluse patendinõudluse ja patendikirjelduse tõlke esitamise ja avalikustamise ning Euroopa patenditaotluse siseriiklikuks patenditaotluseks ja kasuliku mudeli registreerimise taotluseks muutmise kord" § 30 lõike 2 alusel.

- | | |
|--|--|
| <p>(51) A01B 73/02 (2006.01) (10) E003726
 (11) EE-EP 1859665 B1
 (30) 26.05.2006, DE, 102006024479
 (96) 18.05.2007, 07009936.1
 (97) 12.08.2009, EP 1859665
 (54) Järeleveetav suure töölaieuga põllumajanduslik tööriist
 (73) Amazonen-Werke H. Dreyer GmbH & Co. KG
 Am Amazonenwerk 9-13, 49205 Hasbergen, DE
 (72) Thielicke, René, Dr.
 Buchenweg 19, 04420 Markranstädt, DE
 Sosnicki, Jürgen
 Uranusstrasse 2, 04205 Leipzig, DE
 Faber, Andreas
 Dewizter Strasse 108, 04425 Taucha, DE
 (74) Jüri Käosaar
 Patendibüroo Käosaar & Co OÜ
 Tähe 94, 50107 Tartu, EE
 Patendikirjelduse tõlke esitamise kuupäev 11.11.2009</p> | <p>67056 Ludwigshafen, DE
 (72) SEMAR, Martin
 Im Altengarten 5, 76889 Gleiszellen-gleishorbach, DE
 STROBEL, Dieter
 Dackenheimer Weg 23, 67273 Herxheim Am Berg, DE
 BRUNS, Jens
 Albert-schweitzer 12, 67435 Neustadt, DE
 STIERL, Reinhard
 Jahnstr.8, 67251 Freinsheim, DE
 WERNER, Frank
 Erschigweg 9, 67434 Neustadt, DE
 (74) Leevi Markus
 Patendibüroo Käosaar & Co OÜ
 Tähe 94, 50107 Tartu, EE
 Patendikirjelduse tõlke esitamise kuupäev 08.12.2009</p> |
| <p>(51) A01K 13/00 (2006.01) (10) E003727
 (11) EE-EP 1665927 B1
 (30) 11.03.2005, IT, BS20050032
 (96) 23.01.2006, 06100699.5
 (97) 19.08.2009, EP 1665927
 (54) Seade kariloomade harjamiseks
 (73) Agricow S.r.l.
 Via Caduti del Lavoro, 88,
 25013 Carpenedolo (BS), IT
 (72) Musicco, Alberto
 c/o Agricow S.r.l., Via Caduti del Lavoro, 88,
 25013 Carpenedolo BS, IT
 (74) Andres Mutt
 OÜ Lasvet
 Suurtüki 4a, 10133 Tallinn, EE
 Patendikirjelduse tõlke esitamise kuupäev 10.11.2009</p> | <p>(51) A23C 9/13 (2006.01) (10) E003729
 A23D 7/00 (2006.01)
 A23D 9/00 (2006.01)
 A23L 1/29 (2006.01)
 A23L 1/30 (2006.01)
 (11) EE-EP 1959746 B1
 (30) 18.11.2005, FI, 20051184
 (96) 20.11.2006, 06820063.3
 (97) 12.08.2009, EP 1959746
 (54) Täiustatud rasva kompositsioon
 (73) Raisio Oyj
 P.O. Box 101, 21201 Raisio, FI
 (72) WESTER, Ingmar
 Stålarinkatu 19 As. 2, FI-20810 Turku, FI
 PIISPA, Eija
 Kaljalantie 3 B 6, FI-21530 Paimio, FI
 (74) Leevi Markus
 Patendibüroo Käosaar & Co OÜ
 Tähe 94, 50107 Tartu, EE
 Patendikirjelduse tõlke esitamise kuupäev 10.11.2009</p> |
| <p>(51) A01N 43/653 (2006.01) (10) E003728
 A01N 37/42 (2006.01)
 A01P 3/00 (2006.01)
 A01P 21/00 (2006.01)
 (11) EE-EP 1933623 B1
 (30) 07.10.2005, DE, 102005048432
 (96) 29.09.2006, 06793900.9
 (97) 09.09.2009, EP 1933623
 (54) Fungitsiidid ja bioregulaatoorsed segud
 (73) BASF SE</p> | <p>(51) A23L 1/01 (2006.01) (10) E003730
 A23L 1/164 (2006.01)
 A23L 1/217 (2006.01)
 (11) EE-EP 1605774 B1
 (30) 21.02.2003, US, 371448
 (96) 06.02.2004, 04709050.1
 (97) 01.07.2009, EP 1605774
 (54) Meetod akrüülamiidi koguse vähendamiseks</p> |

- (73) termiliselt töödeldud toiduainetes
Frito-Lay North America, Inc.
7701 Legacy Drive, Plano, TX 75024-4099, US
- (72) BARRY, David, Lawrence
2745 Quail Ridge Court, Highland Village,
TX 75077, US
BURNHAM, Colin, Jeffrey
37 Station Road, Quorn, Leicestershire, LE12 8BP,
GB
DESAI, Pravin, Maganlal, Desai
3203 Willow Ridge Trail, Carrollton, TX 75007, US
JOSEPH, Ponnattu, Kurian
701 Rosita Street, Irving, TX 75062, US
LEUNG, Henry, Kin-Hang
3704 Ellington Drive, Plano, TX 75093, US
MASSON, John, Richard
20 St. Catherines Way, Houghton on the Hill,
Leicester LE7 9HE, GB
RAO, Mohan, V., N.
3609 Whitehaven Drive, Plano, TX 75093, US
SAUNDERS, Robert, William
10 Petersham Mews, Nottingham NG7 1HF, GB
STALDER, James, William
4146 Creekdale Drive, Dallas, TX 75229, US
TOPOR, Michael, Grant
2312 Evergreen, Carrollton, TX 75006, US
- (74) Leevi Markus
Patendibüroo Käosaar & Co OÜ
Tähe 94, 50107 Tartu, EE
Patendikirjelduse tõlke esitamise kuupäev 21.09.2009

- (51) **A23L 1/30 (2006.01)** (10) **E003732**
A23L 1/308 (2006.01)
A61P 31/18 (2006.01)
A61K 31/201 (2006.01)
A61K 31/202 (2006.01)
A61K 45/06 (2006.01)
A61K 31/702 (2006.01)
- (11) **EE-EP 1758469 B1**
(30) 22.06.2004, WO, PCT/NL2004/000444
21.04.2005, EP, 05103257
21.04.2005, EP, 05103260
(96) 22.06.2005, 05755280.4
(97) 28.10.2009, EP 1758469
(54) HIV patsientide intestinaalse barjääri terviklikkuse
parandamine rasvhapete kasutamise abil
(73) N.V. Nutricia
Eerste Stationsstraat 186, 2712 HM Zoetermeer, NL
(72) VAN TOL, Eric, Alexander, Franciscus
Roemer Visscherstraat 62, NL-6824 MZ Arnhem,
NL
WILLEMSSEN, Linette, Eustachia, Maria
Croesestraat 94, NL-3522 AJ Utrecht, NL
KOETSIER, Marleen, Antoinette
Abraham Kuijperstraat 3, NL-8161 DW EPE, NL
BEERMANN, Christopher
Bahnhofstrasse 120a, 61267 Neu-Anspach, DE
STAHL, Bernd
Breslauer Strasse 77, 61191 Rosbach, DE
- (74) Tõnu Nelsas
AAA Patendibüroo OÜ
Tartu mnt 16, 10117 Tallinn, EE
Patendikirjelduse tõlke esitamise kuupäev 07.01.2010

- (51) **A23L 1/0528 (2006.01)** (10) **E003731**
A23L 1/09 (2006.01)
A23L 1/29 (2006.01)
A23L 1/30 (2006.01)
A61K 31/01 (2006.01)
A61K 31/702 (2006.01)
A61K 31/715 (2006.01)
A61K 31/733 (2006.01)
- (11) **EE-EP 1927292 B1**
(30) 17.05.2004, EP, 04076479
(96) 17.05.2005, 08151202.2
(97) 26.08.2009, EP 1927292
(54) GOS (galakto-oligosahhariidide) ja polüfruktoosi
sünergism
(73) N.V. Nutricia
Eerste Stationsstraat 186, 2712 HM Zoetermeer, NL
(72) Speelmans, Gelske
Opal 15, 6708 LW, Wageningen, NL
Govers, Maria Johanna Adriana Petronella
Bosmeesterkamp 6a, 6721 AJ, Bennekom, NL
Knol, Jan
Johan Beenstraat 10, 6708 SM, Wageningen, NL
van Tol, Eric Alexander Franciscus
Roemer Visscherstraat 62, 6824 MZ, Arnhem, NL
- (74) Tõnu Nelsas
AAA Patendibüroo OÜ
Tartu mnt 16, 10117 Tallinn, EE
Patendikirjelduse tõlke esitamise kuupäev 24.11.2009

- (51) **A23L 2/02 (2006.01)** (10) **E003733**
(11) **EE-EP 1679981 B1**
(30) 20.10.2003, DE, 10348539
(96) 30.09.2004, 04787066.2
(97) 23.09.2009, EP 1679981
(54) Valgupulber ja sellest saadud valku sisaldav jook
(73) RUDOLF WILD GmbH & CO. KG
Postfach 106220, 69052 Heidelberg, DE
(72) WILD, Hans-Peter
Rudolf-Wild-Strasse 4-6, 69214 Eppelheim, DE
ELLER, Thomas
Nienkemperstrasse 9, 14167 Berlin, DE
SASS, Matthias
Röhlichstrasse 27, 68723 Oftersheim, DE
RIMMLER, Susanne
Karl-Theodor-Strasse 13, 68723 Plankstadt, DE
- (74) Piret Niidas
OÜ Lasvet
Suurtüki 4a, 10133 Tallinn, EE
Patendikirjelduse tõlke esitamise kuupäev 07.12.2009

- (51) **A24D 3/04 (2006.01)** (10) **E003734**
A24D 3/06 (2006.01)
A24D 3/16 (2006.01)
- (11) **EE-EP 1889550 B1**
(96) 04.08.2006, 06254102.4

- (97) 29.07.2009, EP 1889550
 (54) Mitmekomponentne filter mitme maitse intensiivistamiseks
 (73) Philip Morris Products S.A.
 Quai Jeanrenaud 3, 2000 Neuchâtel, CH
 (72) Seitert, Hughes
 Rue Guillaume-Farel 18, CH-2000 Neuchatel, CH
 Lekili, Levent
 Chemin des Ruaux 18, CH-2013 Colombier, CH
 Gawad, Ahmed
 Chemin de la Clergere 5, CH-1027 Lonay, CH
 Kuersteiner, Charles
 Promenade de Flusel 30,
 CH-1008 Jouxens-Mezery, CH
 (74) Toom Pungas
 OÜ Synest
 pk 977, 13402 Tallinn, EE
 Patendikirjelduse tõlke esitamise kuupäev 29.12.2009

- (51) **A24F 47/00 (2006.01)** (10) **E003735**
A24B 15/28 (2006.01)
 (11) **EE-EP 1827146 B1**
 (30) 02.11.2004, US, 979103
 (96) 02.11.2005, 05806873.5
 (97) 30.09.2009, EP 1827146
 (54) Elektriliselt soojendatav sigaret, mis sisaldab kontrollitult vabastatavat lõhna- ja maitseainet
 (73) Philip Morris Products S.A.
 Quai Jeanrenaud 3, 2000 Neuchâtel, CH
 (72) NEWMAN, Deborah, J.
 11866 Centennial Road, Prince George, VA 23875,
 US
 WOODSON, Beverley, C.
 722 Lake Caroline Drive, Ruther Glen, VA 22546,
 US
 (74) Toom Pungas
 OÜ Synest
 pk 977, 13402 Tallinn, EE
 Patendikirjelduse tõlke esitamise kuupäev 30.12.2009

- (51) **A41B 11/02 (2006.01)** (10) **E003736**
 (11) **EE-EP 1796490 B1**
 (30) 02.09.2004, DE, 202004013816 U
 (96) 17.08.2005, 05777586.8
 (97) 21.10.2009, EP 1796490
 (54) Sokk
 (73) X-Technology Swiss, GmbH
 Samstager Strasse 45, 8832 Wollerau, CH
 (72) LAMBERTZ, Bodo, W.
 Etzelstrasse 25, 8808 Pfäffikon, CH
 (74) Riho Pikkor
 Patendibüroo Turvaja OÜ
 Liivalaia 22, 10118 Tallinn, EE
 Patendikirjelduse tõlke esitamise kuupäev 22.12.2009

- (51) **A47B 96/14 (2006.01)** (10) **E003737**
F16S 3/04 (2006.01)
 (11) **EE-EP 1872685 B1**

- (30) 23.03.2005, ES, 200500695
 (96) 17.03.2006, 06725824.4
 (97) 07.10.2009, EP 1872685
 (54) Riiulite kinnitussüsteem
 (73) Esmena S.L.
 La Picota S/N, 33211 Gijon, ES
 (72) MENENDEZ RUIZ, Manuel Jesus
 La Picota, Tremañes, E-33211 Gijon, ES
 (74) Andres Mutt
 OÜ Lasvet
 Suurtüki 4a, 10133 Tallinn, EE
 Patendikirjelduse tõlke esitamise kuupäev 18.12.2009

- (51) **A47C 27/14 (2006.01)** (10) **E003738**
 (11) **EE-EP 1956945 B1**
 (30) 31.10.2005, NO, 20055064
 (96) 31.10.2006, 06812806.5
 (97) 01.07.2009, EP 1956945
 (54) Mööbli polster
 (73) Ekornes ASA
 6222 Ikornnes, NO
 (72) EKORNES, Arve
 6222 Ikornnes, NO
 (74) Jüri Käosaar
 Patendibüroo Käosaar & Co OÜ
 Tähe 94, 50107 Tartu, EE
 Patendikirjelduse tõlke esitamise kuupäev 09.09.2009

- (51) **A47J 31/40 (2006.01)** (10) **E003739**
 (11) **EE-EP 1867257 B1**
 (96) 14.06.2006, 06012333.8
 (97) 14.10.2009, EP 1867257
 (54) Meetod kohvi tõmbamiseks kohviautomaadis
 (73) Rhea Vendors S.p.A.
 Via Trieste, 49, 21042 Caronno Pertusella VA, IT
 (72) Doglioni Majer, Luca
 Via Dei Cristoforis, 14/16,
 22010 Carate Urio (COMO), IT
 (74) Riho Pikkor
 Patendibüroo Turvaja OÜ
 Liivalaia 22, 10118 Tallinn, EE
 Patendikirjelduse tõlke esitamise kuupäev 03.12.2009

- (51) **A61B 5/00 (2006.01)** (10) **E003740**
A61B 5/103 (2006.01)
 (11) **EE-EP 1694203 B1**
 (30) 08.01.2004, GB, 0400281
 (96) 10.01.2005, 05701821.0
 (97) 26.08.2009, EP 1694203
 (54) Süsteem või meetod patsiendi perifeerse vereringe hindamiseks
 (73) DIALOG DEVICES LIMITED
 Rutland Hall Epinal Way Loughborough,
 Leicestershire LE11 3TU, GB
 (72) CRABTREE, Vincent, Peter
 7 Rudyard Close, Loughborough,
 Leicestershire LE11 3TU, GB
 SMITH, Peter Richard

4 Batsons Court, Top Road, Griffydam,
Leicestershire LE67 8HX, GB
(74) Jüri Käosaar
Patendibüroo Käosaar & Co OÜ
Tähe 94, 50107 Tartu, EE
Patendikirjelduse tõlke esitamise kuupäev 25.11.2009

(51) **A61F 2/16 (2006.01)** (10) **E003741**
(11) **EE-EP 1980219 B1**
(30) 11.04.2007, US, 734084
(96) 29.02.2008, 08102172.7
(97) 02.09.2009, EP 1980219
(54) Läätse paigaldussüsteemi kassett ja meetod
(73) Alcon, Inc.
P.O. Box 62, Bösch 69, 6331 Hünenberg, CH
(72) Downer, David A.
5217 Spanish River Trail, Fort Worth, TX 76137,
US
Brown, Kyle
5909 River Bend Drive, Fort Worth, TX 76132, US
Muchala, Sushant
1009 Belmont Drive, Kennedale, TX 76060, US
Cam Tran, Tu
4113 Mapleridge Drive, Grapevine, TX 76051, US
Yan, Dengzhu
4900 Thoroughbred Drive, Arlington, TX 76017, US
(74) Arno Anijalg
Patendibüroo Ustervall OÜ
Kivi 21-6, 51009 Tartu, EE
Patendikirjelduse tõlke esitamise kuupäev 25.11.2009

(51) **A61K 8/90 (2006.01)** (10) **E003742**
A01N 25/02 (2006.01)
A01N 25/04 (2006.01)
A01N 43/90 (2006.01)
A61K 8/67 (2006.01)
A61K 8/98 (2006.01)
A61K 9/14 (2006.01)
A61K 35/04 (2006.01)
A61K 38/28 (2006.01)
A61Q 5/02 (2006.01)
(11) **EE-EP 1993515 B1**
(30) 10.03.2006, CH, 377062006
(96) 09.03.2007, 07710794.4
(97) 29.07.2009, EP 1993515
(54) Meetod ainete solubiliseerimiseks, dispergeerimiseks ja stabiliseerimiseks, sellel meetodil valmistatud tooted ja nende kasutamine
(73) Laboswiss AG
Promenade 87, 7270 Davos-Platz, CH
(72) STROBEL, Hanspeter
Promenade 46, CH-7270 Davos-Platz, CH
(74) Harald Tehver
Patendibüroo Turvaja OÜ
Liivalaia 22, 10118 Tallinn, EE
Patendikirjelduse tõlke esitamise kuupäev 16.11.2009

(51) **A61K 9/00 (2006.01)** (10) **E003743**
A61K 9/19 (2006.01)
C08L 5/08 (2006.01)
C08B 37/00 (2006.01)
(11) **EE-EP 1978925 B1**
(96) 23.12.2005, 05824526.7
(97) 12.08.2009, EP 1978925
(54) Hüdrogeeli moodustav termoreaktiivne neutraalne kitosaani kompositsioon, lüofilisaat ning meetodid nende valmistamiseks
(73) LABORATOIRE MEDIDOM S.A.
24, avenue de Champel, 1206 Geneva, CH
(72) SCHUETZ, Yannic
Croix-du-Nant 13, CH-1872 Troistorrens, CH
CARATTI-BESSON, Virginie
6, ch. de la Brume, CH-1110 Morges, CH
JORDAN, Olivier
15a, ch. Sous-le-Bois, CH-1197 Prangins, CH
GURNY, Robert
7, rue Calvin, CH-1204 Genève, CH
(74) Leevi Markus
Patendibüroo Käosaar & Co OÜ
Tähe 94, 50107 Tartu, EE
Patendikirjelduse tõlke esitamise kuupäev 09.11.2009

(51) **A61K 9/107 (2006.01)** (10) **E003744**
A61K 31/216 (2006.01)
(11) **EE-EP 1648413 B1**
(30) 23.07.2003, US, 489559 P
(96) 21.07.2004, 04757141.9
(97) 07.10.2009, EP 1648413
(54) Lühiajalise toimega rahustava uinuti ravimkoostised
(73) Theravance, Inc.
901 Gateway Boulevard, South San Francisco,
CA 94080, US
(72) JENKINS, Thomas E.
190 Canada Vista Drive, Box 755, La Honda,
CA 94020, US
BOLTON, Jennifer
2375 Mariposa Street 1, San Francisco, CA 94110,
US
(74) Leevi Markus
Patendibüroo Käosaar & Co OÜ
Tähe 94, 50107 Tartu, EE
Patendikirjelduse tõlke esitamise kuupäev 04.12.2009

(51) **A61K 9/12 (2006.01)** (10) **E003745**
A61P 9/14 (2006.01)
(11) **EE-EP 1694292 B1**
(30) 17.11.2003, GB, 0326768
10.02.2004, US, 542867 P
10.02.2004, US, 542866 P
07.10.2004, GB, 0422307
(96) 17.11.2004, 04798566.8
(97) 22.07.2009, EP 1694292
(54) Terapeutiline vaht, mis sisaldab skleroseerivat lahust ja vähest kogust gaasilist lämmastiku
(73) BTG INTERNATIONAL LIMITED
5 Fleet Place, London EC4M 7RD, GB

- (72) WRIGHT, David Dakin Iorwerth
2 Austenwood Close, High Wycombe,
Buckinghamshire HP11 1PT, GB
HARMAN, Anthony David
7 Grange Avenue, Rotherfield Peppard,
Henley on Thames, Oxfordshire RG9 5JP, GB
ROBINSON, Nikki
1 Anchor Cottages, High Street, Cowley,
Uxbridge UB8 2EE, GB
HODGES, Garry
Keaton House, Widewater Place, South Harefield,
Middx UB9 6NS, GB
KADAR, Adil
Keaton House, Widewater Place, South Harefield,
Middx UB9 6NS, GB
MOGGRIDGE, Geoffrey, D.
University of Cambridge Dept. of Chemical
Engineering, New Museums Site, Pembroke Street,
Cambridge CB2 3RA, GB
VAN LIEW, Hugh
100 Goodview Way, Barnstable, MA 02630, US
- (74) Leevi Markus
Patendibüroo Käosaar & Co OÜ
Tähe 94, 50107 Tartu, EE
- Patendikirjelduse tõlke esitamise kuupäev 21.10.2009

-
- (51) **A61K 9/14 (2006.01)** (10) **E003746**
A61K 9/72 (2006.01)
A61M 15/00 (2006.01)
A61J 1/00 (2006.01)
A61K 31/46 (2006.01)
A61P 11/06 (2006.01)
A61P 11/08 (2006.01)
- (11) **EE-EP 1991202 B1**
(30) 03.12.2003, SE, 0303270
(96) 02.12.2004, 04801708.1
(97) 18.11.2009, EP 1991202
(54) Tiotroopiumi manustamise meetod
- (73) Boehringer Ingelheim International GmbH
Binger Strasse 173, 55216 Ingelheim am Rhein, DE
- (72) NILSSON, Thomas
Hagavägen 3, S-647 32 Mariefred, SE
MYRMAN, Mattias
Sundbyvägen 24, S-64551 Strängnäs, SE
CALANDER, Sven
Dalängsgatan 4, S-645 32 Strängnäs, SE
NIEMI, Alf
Bollvägen 1, S-645 50 Strängnäs, SE
- (74) Jürgen Toome
OÜ Lasvet
Suurtüki 4a, 10133 Tallinn, EE
- Patendikirjelduse tõlke esitamise kuupäev 15.12.2009

-
- (51) **A61K 9/14 (2006.01)** (10) **E003747**
(11) **EE-EP 1765290 B1**
(30) 10.03.2004, EP, 04075714
10.03.2004, US, 551330 P
(96) 10.03.2005, 05718248.7
(97) 09.09.2009, EP 1765290

- (54) Steroidsete ravimite stabiliseeritud üleküllastunud tahked lahused
- (73) Bayer Schering Pharma Aktiengesellschaft
Müllerstrasse 178, 13353 Berlin, DE
- (72) FUNKE, Adrian
Arcostrasse 7, 10587 Berlin, DE
WAGNER, Torsten
Strasse 163, Nr. 4, 13127 Berlin, DE
LIPP, Ralph
11780 Auburn Creek Crossing, Zionsville,
IN 46077, US
- (74) Enn Urgas
Patendibüroo Turvaja OÜ
Liivalaia 22, 10118 Tallinn, EE
- Patendikirjelduse tõlke esitamise kuupäev 16.11.2009

-
- (51) **A61K 9/22 (2006.01)** (10) **E003748**
(11) **EE-EP 1803447 B1**
(96) 09.09.2004, 04774809.0
(97) 22.07.2009, EP 1803447
(54) Hüdralasiini väga aeglaselt vabastav farmatseutiline kompositsioon ja selle kasutamine toetava vahendina vähiravis
- (73) Psicofarma, S.A. De C.V.
Calzada de Tlalpan 4369, Col. Toriel Guerra, C.P. 14050, MX
- (72) ESTRADA FLORES Luis
Calzada de Tlalpan 4369, Col. Toriel Guerra, C.P. 14050, MX
DUEÑAS GONZÁLEZ, Alfonso
Calzada de Tlalpan 4369, Col. Toriel Guerra, C.P. 14050, MX
BORBOLLA GARCÍA, Arturo
Calzada de Tlalpan 4369, Col. Toriel Guerra, C.P. 14050, MX
SERNA MARTÍNEZ, Raúl
Calzada de Tlalpan 4369, Col. Toriel Guerra, C.P. 14050, MX
RIVERA HERNÁNDEZ, Alfredo
Calzada de Tlalpan 4369, Col. Toriel Guerra, C.P. 14050, MX
MOHAR BETANCOURT, Alejandro
Calzada de Tlalpan 4369, Col. Toriel Guerra, C.P. 14050, MX
- (74) Piret Niidas
OÜ Lasvet
Suurtüki 4a, 10133 Tallinn, EE
- Patendikirjelduse tõlke esitamise kuupäev 22.10.2009

-
- (51) **A61K 9/48 (2006.01)** (10) **E003749**
A61K 9/28 (2006.01)
A61P 25/18 (2006.01)
A61K 31/498 (2006.01)
- (11) **EE-EP 1853232 B1**
(30) 18.02.2005, US, 654149 P
(96) 17.02.2006, 06708346.9
(97) 19.08.2009, EP 1853232
(54) Bifeprunoksmesülaadi stabiilne kristallivorm, selle ravimvormid ja meetodid nende kasutamiseks

- (73) Solvay Pharmaceuticals B.V.
C.J. van Houtenlaan 36, 1381 CP Weesp, NL
- (72) EIJGENDAAL, Irene
IPSI Department C.j. Van Houtenlaan 36,
NL-1381 CP Weesp, NL
KLEIN, Gerrit
IPSI Department C.j. Van Houtenlaan 36,
NL-1381 CP Weesp, NL
TERHORST-VAN AMSTEL, Maria J.I.
IPSI Department C.j. Van Houtenlaan 36,
NL-1381 CP Weesp, NL
ZWIER, Klaas
IPSI Department C.j. Van Houtenlaan 36,
NL-1381 CP Weesp, NL
BRUINS, Nico
IPSI Department C.j. Van Houtenlaan 36,
NL-1381 CP Weesp, NL
RIGTER, Hendrikus T.
IPSI Department C.j. Van Houtenlaan 36,
NL-1381 CP Weesp, NL
GOUT, Eric
IPSI Department C.j. Van Houtenlaan 36,
NL-1381 CP Weesp, NL
BOON, Caroline
IPSI Department C.j. Van Houtenlaan 36,
NL-1381 CP Weesp, NL
DE VRIES, Michiel H.
IPSI Department C.j. Van Houtenlaan 36,
NL-1381 CP Weesp, NL
- (74) Piret Niidas
OÜ Lasvet
Suurtüki 4a, 10133 Tallinn, EE
Patendikirjelduse tõlke esitamise kuupäev 18.11.2009

- (51) **A61K 9/48 (2006.01)** (10) **E003750**
A61K 8/11 (2006.01)
B01J 13/04 (2006.01)
A23L 1/00 (2006.01)
- (11) **EE-EP 1898889 B1**
(30) 21.06.2005, WO, PCT/EP2005/008502
05.08.2005, WO, PCT/EP2005/009226
(96) 21.06.2006, 06809049.7
(97) 07.10.2009, EP 1898889
(54) Gellaanist purustatav õmblusteta kapsel ja meetod selle valmistamiseks
- (73) V. Mane Fils
620, route de Grasse, 06620 Bar sur Loup, FR
- (72) HARTMANN, Didier
83, avenue Maurice Chevalier, Résidence
La Boissière, Bat. Bambou,
F-06150 Cannes La Bocca, FR
HANNETEL, Jean-Michel
6, rue Jeanne Jugan, F-06130 Grasse, FR
COURSIERES, Nathalie
580 chemin de la Stèle,
F-06530 St Cézaire sur Siagne, FR
MANE, Jean
Domaine Saint-Mathieu,
290, route de Saint-Mathieu, F-06130 Grasse, FR
- (74) Enn Urgas

Patendibüroo Turvaja OÜ
Liivalaia 22, 10118 Tallinn, EE
Patendikirjelduse tõlke esitamise kuupäev 29.12.2009

- (51) **A61K 31/047 (2006.01)** (10) **E003751**
A61K 31/22 (2006.01)
A61P 27/02 (2006.01)
- (11) **EE-EP 1744736 B1**
(30) 14.05.2004, US, 571162 P
(96) 12.05.2005, 05751168.5
(97) 18.11.2009, EP 1744736
(54) Meetod kuiva silma haiguste ja soonkestapõletiku ravimiseks
- (73) Alcon, Inc.
Bosch 69, P.O. Box 62, 6331 Hünenberg, CH
- (72) KLIMKO, Peter, G.
2115 Pembroke Drive, Fort Worth, TX 76110, US
HELLBERG, Mark, R.
3002 Oak Cove Road, Arlington, Texas 76017, US
GAMACHE, Daniel, A.
5610 Hunterwood Lane, Arlington, TX 76017, US
- (74) Raivo Koitel
Patendi- & Kaubamärgibüroo Koitel OÜ
Tartu mnt 65, 10115 Tallinn, EE
Patendikirjelduse tõlke esitamise kuupäev 05.01.2010

- (51) **A61K 31/135 (2006.01)** (10) **E003752**
A61K 31/55 (2006.01)
A61P 3/04 (2006.01)
- (11) **EE-EP 1833473 B1**
(30) 23.12.2004, US, 638667 P
08.06.2005, US, 688901 P
(96) 21.12.2005, 05855247.2
(97) 09.09.2009, EP 1833473
(54) 5-HT_{2C}-retseptori modulaatori kompositsioonid ja nende kasutamise meetodid
- (73) Arena Pharmaceuticals, Inc.
6166 Nancy Ridge Drive, San Diego, CA 92121, US
- (72) BEHAN, Dominic P.
11479 Weatherhill Way, San Diego, CA 92131, US
SMITH, Brian M.
13182 Mesa Crest Place, San Diego, CA 92129, US
BJENNING, Christina
768 Sonrisa Street, Solana Beach, CA 92075, US
- (74) Piret Niidas
OÜ Lasvet
Suurtüki 4a, 10133 Tallinn, EE
Patendikirjelduse tõlke esitamise kuupäev 30.11.2009

- (51) **A61K 31/137 (2006.01)** (10) **E003753**
A61K 31/18 (2006.01)
A61K 31/505 (2006.01)
A61K 45/00 (2006.01)
A61P 13/00 (2006.01)
- (11) **EE-EP 1728508 B1**
(30) 24.03.2004, JP, 2004004000
(96) 17.03.2005, 05721012.2
(97) 09.09.2009, EP 1728508

- (54) Ravim sagedase urineerimise või uriinipidamatus
 ennetamiseks või raviks
- (73) Kissei Pharmaceutical Co., Ltd.
 19-48, Yoshino Matsumoto-shi, Nagano 399-8710,
 JP
- (72) YAMAZAKI, Yoshinobu
 c/o Central Res. Lab., 4365-1, Oaza Kashiwabara,
 Hotaka-machi, Minamiazumi-gun, Nagano 3998304,
 JP
 KOJIMA, Masami
 c/o Central Res. Lab., 4365-1, Oaza Kashiwabara,
 Hotaka-machi, Minamiazumi-gun,
 Nagano 3998304, JP
- (74) Leevi Markus
 Patendibüroo Käosaar & Co OÜ
 Tähe 94, 50107 Tartu, EE
- Patendikirjelduse tõlke esitamise kuupäev 08.12.2009

- (51) **A61K 31/275 (2006.01)** (10) **E003754**
A61K 31/195 (2006.01)
A61K 9/28 (2006.01)
A61K 9/48 (2006.01)
A61K 9/16 (2006.01)
- (11) **EE-EP 1896006 B1**
 (30) 08.06.2005, US, 688334 P
 (96) 07.06.2006, 06755404.8
 (97) 07.10.2009, EP 1896006
- (54) Suukaudsetes ravimvormides kasutatavate entaka-
 pooni sisaldavate graanulite valmistamismeetod
- (73) Orion Corporation
 Orionintie 1, 02200 Espoo, FI
- (72) VAHERVUO, Kari
 Maininkitie 3 C 11, FI-002320 Espoo, FI
- (74) Tõnu Nelsas
 AAA Patendibüroo OÜ
 Tartu mnt 16, 10117 Tallinn, EE
- Patendikirjelduse tõlke esitamise kuupäev 21.12.2009

- (51) **A61K 31/335 (2006.01)** (10) **E003755**
 (11) **EE-EP 1814538 B1**
 (30) 24.11.2004, US, 630886 P
 (96) 31.10.2005, 05820776.2
 (97) 23.09.2009, EP 1814538
- (54) Meetod ninasprei väljutamiseks
- (73) Alcon, Inc.
 P.O. Box 62, Bösch 69, 6331 Hünenberg, CH
- (72) CAGLE, Gerald
 6309 Greenway, Fort Worth, Texas 76116, US
 WALL, G., Michael
 4417 Ledgeview Road, Fort Worth, TX 76109, US
- (74) Arno Anijalg
 Patendibüroo Ustervall OÜ
 Kivi 21-6, 51009 Tartu, EE
- Patendikirjelduse tõlke esitamise kuupäev 19.11.2009

- (51) **A61K 31/352 (2006.01)** (10) **E003756**
A61K 31/353 (2006.01)
A61K 31/357 (2006.01)

A61P 29/00 (2006.01)

- (11) **EE-EP 1973540 B1**
 (30) 19.12.2005, US, 751686 P
 15.02.2006, US, 773812 P
 18.12.2006, US, 612071
- (96) 19.12.2006, 06847800.7
- (97) 11.11.2009, EP 1973540
- (54) Bensokondenseerunud heterotsükliiliste sulfamiid-
 derivaatide kasutamine valu ravimiseks
- (73) Janssen Pharmaceutica N.V.
 Turnhoutseweg 30, 2340 Beerse, BE
- (72) SMITH-SWINTOSKY, Virginia L.
 3163 Line Lexington Road, Hatfield, PA 19440, US
 REITZ, Allen B.
 109 Greenbriar Road, Lansdale, PA 19446, US
- (74) Harald Tehver
 Patendibüroo Turvaja OÜ
 Liivalaia 22, 10118 Tallinn, EE
- Patendikirjelduse tõlke esitamise kuupäev 11.12.2009

- (51) **A61K 31/40 (2006.01)** (10) **E003757**
A61K 9/22 (2006.01)
A61K 9/24 (2006.01)
- (11) **EE-EP 1898904 B1**
 (30) 10.06.2005, US, 689719 P
 14.06.2005, US, 690309 P
- (96) 08.06.2006, 06772653.9
- (97) 07.10.2009, EP 1898904
- (54) Toimeainet modifitseeritud vabastav 1-[(3-hüdroksü-
 adamant-1-üülamino)-atsetüül]-pürrolidiin-2(S)-
 karbonitriili formulatsioon
- (73) Novartis AG
 Lichtstrasse 35, 4056 Basel, CH
- (72) KOWALSKI, James
 3727 Symes Drive, Belle Mead, NJ 08502, US
 LAKSHMAN, Jay, Parthiban
 215 Vista Drive, Cedar Knolls, NJ 07927, US
 SERAJUDDIN, Abu, T. M.
 172-11 35 Avenue, Flushing, Queens, NY 11358,
 US
 JOSHI, Yatindra
 38 Walker Drive, Princeton, NJ 08540, US
- (74) Leevi Markus
 Patendibüroo Käosaar & Co OÜ
 Tähe 94, 50107 Tartu, EE
- Patendikirjelduse tõlke esitamise kuupäev 07.01.2010

- (51) **A61K 31/40 (2006.01)** (10) **E003758**
A61K 31/58 (2006.01)
A61K 31/4015 (2006.01)
A61P 11/00 (2006.01)
A61P 29/00 (2006.01)
A61P 1/04 (2006.01)
A61P 11/06 (2006.01)
A61P 13/12 (2006.01)
A61P 17/06 (2006.01)
A61P 19/02 (2006.01)
A61P 25/28 (2006.01)
A61P 37/00 (2006.01)

- A61P 37/08 (2006.01)**
 (11) **EE-EP 1971369 B1**
 (30) 21.12.2005, US, 752058 P
 (96) 01.12.2006, 06829226.7
 (97) 19.08.2009, EP 1971369
 (54) R,R-glükopürrolaadi, roliprami ja budelsoniidi kombinatsioon, mis on ette nähtud põletikuliste haiguste raviks
 (73) MEDA Pharma GmbH & Co. KG
 Benzstrasse 1, 61352 Bad Homburg, DE
 (72) MAUS, Joachim
 Ludwigstrasse 30, 63165 Mühlheim, DE
 KASTRUP, Horst
 Heekweg 55, 48161 Münster, DE
 BAUHOFER, Artur
 Fachspann 12, 35039 Marburg, DE
 CNOTA, Peter
 Kaiser-Friedrich-Promenade 82,
 61348 Bad Homburg, DE
 SZELENYI, Istvan
 Händelstrasse 32, 90571 Schwaig, DE
 (74) Tõnu Nelsas
 AAA Patendibüroo OÜ
 Tartu mnt 16, 10117 Tallinn, EE
 Patendikirjelduse tõlke esitamise kuupäev 12.11.2009

- (51) **A61K 31/404 (2006.01)** (10) **E003759**
A61P 25/00 (2006.01)
A61P 25/24 (2006.01)
 (11) **EE-EP 1791537 B1**
 (30) 19.08.2004, US, 603348 P
 (96) 19.08.2005, 05785433.3
 (97) 14.10.2009, EP 1791537
 (54) 3-arüültioindool-2-karboksamiidderivaadid ja nende analoogid kui kaseiinkinaas I inhibiitorid
 (73) Aventis Pharmaceuticals Inc.
 300 Somerset Corporate Boulevard, Bridgewater,
 New Jersey 08807, US
 (72) METZ, William Arthur, Jr.
 45 Shannon Road, Bridgewater, NJ 08807, US
 (74) Harald Tehver
 Patendibüroo Turvaja OÜ
 Liivalaia 22, 10118 Tallinn, EE
 Patendikirjelduse tõlke esitamise kuupäev 06.01.2010

- (51) **A61K 31/416 (2006.01)** (10) **E003760**
A61P 3/10 (2006.01)
A61P 5/50 (2006.01)
A61P 9/12 (2006.01)
 (11) **EE-EP 1651213 B1**
 (30) 31.07.2003, DE, 10335027
 06.10.2003, DE, 10346260
 05.12.2003, DE, 10356815
 (96) 24.07.2004, 04763484.5
 (97) 23.09.2009, EP 1651213
 (54) Angiotensiin II retseptori antagonistide, eriti telmisartaani kasutamine insuliinitundlikkuse suurendamiseks
 (73) Boehringer Ingelheim International GmbH

- Binger Strasse 173, 55216 Ingelheim am Rhein, DE
 (72) KAUSCHKE, Stefan
 Akazienweg 47, 88400 Biberach, DE
 MARK, Michael
 Hugo-Haering-Strasse 50, 88400 Biberach, DE
 KINTSCHER, Ulrich
 Pappelallee 20, 10437 Berlin, DE
 SCHUPP, Michael
 Charité-Universitätsmedizin Berlin,
 Hessische Str. 3-4, 10115 Berlin, DE
 UNGER, Thomas
 Thannerpfad 11, 14195 Berlin, DE
 (74) Piret Niidas
 OÜ Lasvet
 Suurtüki 4a, 10133 Tallinn, EE
 Patendikirjelduse tõlke esitamise kuupäev 08.12.2009

- (51) **A61K 31/42 (2006.01)** (10) **E003761**
A61P 25/02 (2006.01)
 (11) **EE-EP 1817029 B1**
 (30) 16.11.2004, IT, MI20042187
 (96) 14.11.2005, 05815995.5
 (97) 16.09.2009, EP 1817029
 (54) Isoksasooli derivaadi kasutamine neuropaatilise valu leevendamiseks
 (73) ZAMBON S.p.A.
 Via Lillo del Duca, 10, 20091 Bresso MI, IT
 (72) NAPOLETANO, Mauro
 Via Venini, 37, I-20127 MILANO, IT
 MORIGGI, Ermanno
 Largo Crivelli, 5, I-21052 BUSTO ARSIZIO, IT
 (74) Leevi Markus
 Patendibüroo Käosaar & Co OÜ
 Tähe 94, 50107 Tartu, EE
 Patendikirjelduse tõlke esitamise kuupäev 14.12.2009

- (51) **A61K 31/47 (2006.01)** (10) **E003762**
A61K 31/4709 (2006.01)
C07D 215/14 (2006.01)
C07D 215/22 (2006.01)
C07D 215/38 (2006.01)
C07D 401/04 (2006.01)
C07D 401/06 (2006.01)
C07D 401/12 (2006.01)
C07D 401/14 (2006.01)
C07D 405/04 (2006.01)
C07D 405/06 (2006.01)
C07D 405/12 (2006.01)
C07D 405/14 (2006.01)
C07D 409/04 (2006.01)
C07D 409/14 (2006.01)
 (11) **EE-EP 1711181 B1**
 (30) 23.01.2004, US, 538907 P
 (96) 21.01.2005, 05701589.3
 (97) 30.09.2009, EP 1711181
 (54) Kinoliini derivaadid ja nende kasutamine mükobakteriaalsete inhibiitoritena
 (73) Janssen Pharmaceutica NV
 Turnhoutseweg 30, 2340 Beerse, BE

- (72) GUILLEMONT, J. E. G.
Johnson & Johnson R & D, Campus de Maigremon,
BP 615, 27106 Val-de-Reuil Cedex, FR
PASQUIER, E. T. J.
Johnson & Johnson R & D, Campus de Maigremon,
BP 615, 27106 Val-de-Reuil Cedex, FR
LANCOIS, D. F. A.
Johnson & Johnson R & D, Campus de Maigremon,
BP 615, 27106 Val-de-Reuil Cedex, FR
- (74) Harald Tehver
Patendibüroo Turvaja OÜ
Liivalaia 22, 10118 Tallinn, EE
- Patendikirjelduse tõlke esitamise kuupäev 17.12.2009

- (51) **A61K 31/47 (2006.01)** (10) **E003763**
C07D 215/26 (2006.01)
C07D 401/12 (2006.01)
A61P 29/00 (2006.01)
- (11) **EE-EP 1513531 B1**
(30) 07.06.2002, IT, MI20021247
(96) 05.06.2003, 03757025.6
(97) 21.10.2009, EP 1513531
- (54) Aluselised mittepeptiidsed bradükiniini antagonistid
ja neid sisaldavad ravimkompositsioonid
- (73) Menarini Ricerche S.p.A.
Via Tito Speri, 10, 00040 Pomezia, IT
- (72) CALVANI, Federico
Via Tito Speri, 10, I-00040 Pomezia, IT
CATRAMBONE, Fernando
Via Tito Speri, 10, I-00040 Pomezia, IT
FELICETTI, Patrizia
Via Tito Speri, 10, I-00040 Pomezia, IT
FINCHAM, Christopher, Ingo
Via Tito Speri, 10, I-00040 POMEZIA, IT
GIOLITTI, Alessandro
Via Tito Speri, 10, I-00040 Pomezia, IT
MAGGI, Carlo, Alberto
Via Tito Speri, 10, I-00040 Pomezia, IT
QUARTARA, Laura
Via Tito Speri, 10, I-00040 Pomezia, IT
ROSSI, Cristina
Via Tito Speri, 10, I-00040 Pomezia, IT
TERRACCIANO, Rosa
Via Tito Speri, 10, I-00040 Pomezia, IT
- (74) Enn Urgas
Patendibüroo Turvaja OÜ
Liivalaia 22, 10118 Tallinn, EE
- Patendikirjelduse tõlke esitamise kuupäev 28.12.2009

- (51) **A61K 31/485 (2006.01)** (10) **E003764**
A61K 9/22 (2006.01)
A61K 9/32 (2006.01)
- (11) **EE-EP 1897545 B1**
(30) 25.08.2006, US, 840244 P
(96) 24.08.2007, 07114982.7
(97) 30.09.2009, EP 1897545
- (54) Rikkumiskindlad suukaudsed opioidset analgeetikumi sisaldavad farmatseutilised annustamisvormid
- (73) Purdue Pharma LP

- One Stamford Forum, 201 Tresser Boulevard,
Stamford, CT 06901, US
- (72) Mannion, Richard Owen
3860 Green Ridge Road, Furlong, PA 18925, US
O'Donnell, Edward Patrick
38 Chestnut Court, Basking Ridge, NJ 07920, US
McKenna, William Henry
10 Longmeadow Road, Yonkers, NY 10704, US
Huang, Haiyong Hugh
33 Ketley Place, Princeton, NJ 08540, US
- (74) Raivo Koitel
Patendi- & Kaubamärgibüroo Koitel OÜ
Tartu mnt 65, 10115 Tallinn, EE
- Patendikirjelduse tõlke esitamise kuupäev 30.12.2009

- (51) **A61K 31/485 (2006.01)** (10) **E003765**
A61P 25/04 (2006.01)
A61K 9/20 (2006.01)
- (11) **EE-EP 1838318 B1**
(30) 18.01.2005, US, 645490 P
(96) 17.01.2006, 06700652.8
(97) 21.10.2009, EP 1838318
- (54) Oksükodooni kasutamine vistseraalse valu ravimiseks
- (73) EURO-CELTIQUE S.A.
2, avenue Charles de Gaulle, 1653 Luxembourg, LU
- (72) DREWES, Asbjorn Mohr
Himmelbjergvej 1, Laven, DK-8600 Silkeborg, DK
NIELSEN, Lars Arendt
M A Schultz Vej 7, DK-9000 Aalborg, DK
- (74) Raivo Koitel
Patendi- & Kaubamärgibüroo Koitel OÜ
Tartu mnt 65, 10115 Tallinn, EE
- Patendikirjelduse tõlke esitamise kuupäev 16.12.2009

- (51) **A61K 31/517 (2006.01)** (10) **E003766**
C07D 403/12 (2006.01)
C07D 401/14 (2006.01)
C07D 403/14 (2006.01)
- (11) **EE-EP 1463506 B1**
(30) 24.12.2001, EP, 01403357
(96) 20.12.2002, 02788214.1
(97) 21.10.2009, EP 1463506
- (54) Asendatud kinosaliini derivaadid Aurora kinaaside inhibiitoritena
- (73) AstraZeneca AB
151 85 Södertälje, SE
- (72) JUNG, Frederic Henri
Z.I. la pompelle, BP 1050, Cedex 2, 51689 Reims, FR
PASQUET, Georges Rene
Z.I. la pompelle, BP 1050, Cedex 2, 51689 Reims, FR
- (74) Enn Urgas
Patendibüroo Turvaja OÜ
Liivalaia 22, 10118 Tallinn, EE
- Patendikirjelduse tõlke esitamise kuupäev 04.12.2009

- (51) **A61K 31/55 (2006.01)** (10) **E003767**
A61P 15/12 (2006.01)
 GlaxoSmithKline, Medicines Research Centre,
 Gunnels Wood Road, Stevenage,
 Hertfordshire, SG1 2NY, GB
- (11) **EE-EP 1814555 B1**
 (30) 15.11.2004, EP, 04105778
 (96) 14.11.2005, 05808013.6
 (97) 19.08.2009, EP 1814555
 (54) *S*-mirtasapiini kasutamise kuumahoogude raviks
 (73) N.V. Organon
 Kloosterstraat 6, NL-5349 AB Oss, NL
- (72) PEETERS, B.W.M.M., Bernardus
 N.V. Organon, P.O. Box 20, NL-5340 BH Oss, NL
 ADANG, Anton Egbert Peter
 N.V. ORGANON, P.O. Box 20, NL-5340 BH OSS,
 NL
- (74) Leevi Markus
 Patendibüroo Käosaar & Co OÜ
 Tähe 94, 50107 Tartu, EE
 Patendikirjelduse tõlke esitamise kuupäev 13.11.2009
-
- (51) **A61K 31/55 (2006.01)** (10) **E003768**
C07D 223/16 (2006.01)
C07D 401/12 (2006.01)
C07D 403/12 (2006.01)
A61P 25/00 (2006.01)
C07D 401/14 (2006.01)
C07D 413/14 (2006.01)
C07D 417/14 (2006.01)
C07D 409/14 (2006.01)
C07D 417/12 (2006.01)
C07D 409/12 (2006.01)
C07D 413/12 (2006.01)
C07D 471/04 (2006.01)
C07D 491/04 (2006.01)
C07D 403/14 (2006.01)
- (11) **EE-EP 1572215 B1**
 (30) 20.12.2002, GB, 0229820
 02.06.2003, GB, 0312607
 (96) 18.12.2003, 03785885.9
 (97) 02.09.2009, EP 1572215
 (54) Neuroloogiliste häirete raviks kasutatavad
 benso[d]asepiini derivaadid
 (73) GLAXO GROUP LIMITED
 Glaxo Wellcome House, Berkeley Avenue,
 Greenford, Middlesex UB6 ONN, GB
- (72) BAMFORD, Mark
 GlaxoSmithKline, Medicines Research Centre,
 Gunnels Wood Road, Stevenage,
 Hertfordshire, SG1 2NY, GB
 DEAN, David, Kenneth
 GlaxoSmithKline, New Frontiers Science Park,
 South Third Avenue, Harlow, Essex CM19 5AW,
 GB
 SEHMI, Sanjeet, Singh
 GlaxoSmithKline, New Frontiers Science Park,
 South Third Avenue, Harlow, Essex CM19 5AW,
 GB
 WILSON, David, Matthew
 GlaxoSmithKline, Medicines Research Centre,
 Gunnels Wood Road, Stevenage,
 Hertfordshire, SG1 2NY, GB
 WITHERINGTON, Jason
- (74) Leevi Markus
 Patendibüroo Käosaar & Co OÜ
 Tähe 94, 50107 Tartu, EE
 Patendikirjelduse tõlke esitamise kuupäev 01.12.2009
-
- (51) **A61K 31/5513 (2006.01)** (10) **E003769**
 (11) **EE-EP 1727551 B1**
 (30) 19.03.2004, GB, 0406279
 (96) 18.03.2005, 05728747.6
 (97) 09.09.2009, EP 1727551
 (54) Farmatseutiline kompositsioon, mis sisaldab benso-
 diasepiini derivaati ja RSV fusioonvalgu inhibiitorit
 (73) Arrow Therapeutics Limited
 Britannia House, 7 Trinity Street, London SE1 1DA,
 GB
- (72) POWELL, Kenneth
 Arrow Therapeutics Limited
 Britannia House, 7 Trinity Street, London SE1 1DA,
 GB
 KELSEY, Richard
 Arrow Therapeutics Limited
 Britannia House, 7 Trinity Street, London SE1 1DA,
 GB
 CARTER, Malcom
 Arrow Therapeutics Limited
 Britannia House, 7 Trinity Street, London SE1 1DA,
 GB
 DOWDELL, Verity
 Arrow Therapeutics Limited
 Britannia House, 7 Trinity Street, London SE1 1DA,
 GB
 ALBER, Dagmar
 Arrow Therapeutics Limited
 Britannia House, 7 Trinity Street, London SE1 1DA,
 GB
 HENDERSON, Elisa
 Arrow Therapeutics Limited
 Britannia House, 7 Trinity Street, London SE1 1DA,
 GB
- (74) Piret Niidas
 OÜ Lasvet
 Suurtüki 4a, 10133 Tallinn, EE
 Patendikirjelduse tõlke esitamise kuupäev 20.11.2009
-
- (51) **A61K 31/70 (2006.01)** (10) **E003770**
A61K 47/10 (2006.01)
A61K 47/12 (2006.01)
A61K 47/26 (2006.01)
- (11) **EE-EP 1480653 B1**
 (30) 31.10.2001, US, 334751 P
 (96) 31.10.2002, 02786612.8
 (97) 19.08.2009, EP 1480653
 (54) Ribaviriini siirupi formulatsioonid
 (73) Schering Corporation
 2000 Galloping Hill Road,
 Kenilworth, NJ 07033-0530, US

- (72) HEIMBECHER, Susan, K.
5 Walsh Way, Morris Plains, NJ 07950, US
SEQUEIRA, Joel, A.
1453 Maseno Drive, Venice, Florida 34292, US
- (74) Leevi Markus
Patendibüroo Käosaar & Co OÜ
Tähe 94, 50107 Tartu, EE
- Patendikirjelduse tõlke esitamise kuupäev 18.11.2009

-
- (51) **A61K 31/7076 (2006.01)** (10) **E003771**
A61P 37/06 (2006.01)
- (11) **EE-EP 1891961 B1**
(96) 17.03.2005, 05728461.4
(97) 16.09.2009, EP 1891961
- (54) 5'-metüültioadenosiini (MTA) kasutamine autoimmuunhaiguste ja/või transplantaadi hülgamisreaktsiooni ärahoidmisel ja/või ravis
- (73) Proyecto de Biomedicina Cima, S.L.
C/Etxesakan 28, Oficina 5, (Pta. Baja),
31180 Cizur Mayor (Navarra), ES
- (72) VILLOSLADA DIAZ, Pablo
EDIFICIO CIMA, Avda Pio XII, 55,
E-31008 Pamplona, ES
AVILA ZARAGOZA, Matías
EDIFICIO CIMA, Avda Pio XII, 55,
E-31008 Pamplona, ES
MORENO BRUNA, Beatriz
EDIFICIO CIMA, Avda Pio XII, 55,
E-31008 Pamplona, ES
CORRALES IZQUIERDO, Fernando
EDIFICIO CIMA, Avda Pio XII, 55,
E-31008 Pamplona, ES
BERASAIN LASARTE, Carmen
EDIFICIO CIMA, Avda Pio XII, 55,
E-31008 Pamplona, ES
RUIZ GARCIA-TREVIJANO, Elena
C/Felix Pizcueta 3, pta. 5, 46004 Valencia, ES
- (74) Piret Niidas
OÜ Lasvet
Suurtüki 4a, 10133 Tallinn, EE
- Patendikirjelduse tõlke esitamise kuupäev 10.12.2009

-
- (51) **A61K 33/26 (2006.01)** (10) **E003772**
A61K 47/26 (2006.01)
A61P 25/28 (2006.01)
A61P 37/02 (2006.01)
- (11) **EE-EP 1848446 B1**
(30) 09.02.2005, EP, 05100907
(96) 18.01.2006, 06707742.0
(97) 14.10.2009, EP 1848446
- (54) Raud(III)-kompleksühendite kasutamine
- (73) VIFOR (INTERNATIONAL) AG
Rechenstrasse 37, 9001 St. Gallen, CH
- (72) TANNER-BAUMGARTNER, Jessica
Seeblickstrasse 6a, CH-9010 St. Gallen, CH
CHANDRA, Ranjeet
5229 Dundas Street West Suite 2108, Etobicoke,
Ontario M9B6L9, CA
GEISSER, Peter

- Maarweesstrasse 8, CH-9014 St. Gallen, CH
- (74) Enn Urgas
Patendibüroo Turvaja OÜ
Liivalaia 22, 10118 Tallinn, EE
- Patendikirjelduse tõlke esitamise kuupäev 15.12.2009

-
- (51) **A61K 35/74 (2006.01)** (10) **E003773**
A61K 31/80 (2006.01)
A61P 1/06 (2006.01)
A61P 1/14 (2006.01)
A61P 1/00 (2006.01)
- (11) **EE-EP 1782818 B1**
(30) 26.10.2005, IT, RM20050531
(96) 29.03.2006, 06425217.4
(97) 30.09.2009, EP 1782818
- (54) *Bacillus Coagulans*'i ja simetikooni sisaldav ravimkompositsioon gastrointestinaalsete patoloogiate raviks
- (73) D.M.G. Italia Srl
Via Laurentina Km 26,700, 00040 Pomezia (RM), IT
- (72) Mercuri, Luigi
Via Laurentina Km. 26,700, 00040 Pomezia (RM), IT
- (74) Enn Urgas
Patendibüroo Turvaja OÜ
Liivalaia 22, 10118 Tallinn, EE
- Patendikirjelduse tõlke esitamise kuupäev 11.12.2009

-
- (51) **A61K 38/36 (2006.01)** (10) **E003774**
A61P 7/00 (2006.01)
A61P 9/00 (2006.01)
- (11) **EE-EP 1691827 B1**
(30) 25.06.2004, AT, 10872004
13.01.2005, AT, 402005
(96) 24.06.2005, 05752350.8
(97) 19.08.2009, EP 1691827
- (54) Inimese fibrinogeeni Bbeetaahelast tulenevate peptiidide kasutamine šoki ravimiseks
- (73) Fibrex Medical Research & Development GmbH
Rabensteig 8/3A, 1010 Wien, AT
- (72) PETZELBAUER, Peter
Lechthalergasse 49, Haus 17, A-1230 Wien, AT
ZACHAROWSKI, Kai
Corellistrasse 15, 40593 Düsseldorf, DE
- (74) Raivo Koitel
Patendi- & Kaubamärgibüroo Koitel OÜ
Tartu mnt 65, 10115 Tallinn, EE
- Patendikirjelduse tõlke esitamise kuupäev 18.11.2009

-
- (51) **A61K 39/02 (2006.01)** (10) **E003775**
(11) **EE-EP 1523330 B1**
(30) 15.07.2002, GB, 0216414
29.08.2002, GB, 0220100
(96) 14.07.2003, 03763843.4
(97) 09.09.2009, EP 1523330
- (54) *Arthrobacter*'i rakkudel põhinev vaktsiin lõheliste riketsiosse septitseemia vastu
- (73) Novartis AG

(72) Lichtstrasse 35, 4056 Basel, CH
 SALONIUS, Kira
 22 Howard Street, Victoria,
 Prince Edward Island COA 2GO, CA
 GRIFFITHS, Steven, Gareth
 239 Weldon Street, Moncton,
 New Brunswick E1C 5 W8, CA
 (74) Leevi Markus
 Patendibüroo Käosaar & Co OÜ
 Tähe 94, 50107 Tartu, EE
 Patendikirjelduse tõlke esitamise kuupäev 03.12.2009

(51) **A61K 39/02 (2006.01)** (10) **E003776**
C12N 1/20 (2006.01)
 (11) **EE-EP 1651260 B1**
 (30) 25.07.2003, US, 490001 P
 (96) 15.07.2004, 04778282.6
 (97) 09.09.2009, EP 1651260
 (54) Euroopa päritoluga *Lawsonia intracellularis* ja vaktsiinid, diagnostilised ained ning nende kasutamise meetodid
 (73) BOEHRINGER INGELHEIM VETMEDICA, INC.
 2621 North Belt Highway,
 St. Joseph MO 64506-2002, US
 (72) ROOF, Michael, B
 3222 Tupelo Circle, Ames, IA 50016, US
 KROLL, Jeremy, J.
 14217 Maple Drive, Urbandale, IA 50323, US
 KNITTEL, Jeffrey, P.
 4400 Philodendron Court, Melbourne, FL 32934, US
 (74) Piret Niidas
 OÜ Lasvet
 Suurtüki 4a, 10133 Tallinn, EE
 Patendikirjelduse tõlke esitamise kuupäev 27.11.2009

(51) **A61K 39/395 (2006.01)** (10) **E003777**
C12P 21/08 (2006.01)
 (11) **EE-EP 1624891 B1**
 (30) 06.05.2003, US, 468837 P
 (96) 06.05.2004, 04751357.7
 (97) 26.08.2009, EP 1624891
 (54) Hüübimisfaktor Fc ja kimäärsed valgud hemofiilia raviks
 (73) SYNTONIX PHARMACEUTICALS, INC.
 9 Fourth Avenue, Waltham, MA 02451, US
 (72) RIVERA, Daniel, S.
 31 Barque Hill Drive, Nonwell, MA 02061, US
 PETERS, Robert, T.
 51 Newfield Street, West Roxbury, MA 02132, US
 BITONTI, Alan, J.
 32 Carlton Drive, Acton, MA 01720, US
 (74) Mart Enn Koppel
 Patendibüroo Koppel OÜ
 Kajaka 4-10, 11317 Tallinn, EE
 Patendikirjelduse tõlke esitamise kuupäev 26.11.2009

(51) **A61K 39/395 (2006.01)** (10) **E003778**
A61P 27/00 (2006.01)

(11) **EE-EP 1933869 B1**
 (30) 01.09.2005, US, 713792 P
 11.08.2006, US, 837312 P
 (96) 30.08.2006, 06813945.0
 (97) 14.10.2009, EP 1933869
 (54) IL-23 ja IL-17 antagonistide kasutamine autoimmuunse põletikulise silmahaiguse ravimiseks
 (73) Schering Corporation
 2000 Galloping Hill Road,
 Kenilworth, NJ 07033-0530, US
 The Government of the United States of America as represented by The Secretary of the Department of Health and Human Services,
 National Institutes of Health, Office of Technology Transfer, Suite 325, 6011 Executive Boulevard, Rockville, MD 20852-3804, US
 (72) CUA, Daniel, J.
 17418 Bear Creek Road, Boulder Creek, CA 95006, US
 KASTELEIN, Robert, A.
 463 Summit Drive, Redwood City, CA 94062, US
 TSAI, Van, T.
 12892 Ralston Circle, San Diego, CA 92130, US
 CASPI, Rachel
 4508 Avamere Street, Bethesda, MD 20814, US
 SILVER, Phyllis
 1921 Locust Grove Road, Silver Spring, MD 20910, US
 LUGER, Dror
 371 Congressional Lane, Rockville, MD 20852, US
 (74) Harald Tehver
 Patendibüroo Turvaja OÜ
 Liivalaia 22, 10118 Tallinn, EE
 Patendikirjelduse tõlke esitamise kuupäev 11.12.2009

(51) **A61K 39/395 (2006.01)** (10) **E003779**
A61P 37/08 (2006.01)
A61P 11/06 (2006.01)
G01N 33/53 (2006.01)
C07K 16/28 (2006.01)
 (11) **EE-EP 1482973 B1**
 (30) 15.03.2002, US, 364513 P
 (96) 13.03.2003, 03716515.6
 (97) 19.08.2009, EP 1482973
 (54) Meetodid CD200 retseptorite moduleerimiseks
 (73) Schering Corporation
 2000 Galloping Hill Road,
 Kenilworth, NJ 07033-0530, US
 (72) CHERWINSKI, Holly, M.,
 17100 Cougar Rock Road,
 Boulder Creek, CA 95006, US
 PHILLIPS, Joseph, H.,
 1511 Walnut Drive, Palo Alto, CA 94303, US
 SEDGWICK, Jonathon, D.,
 4047 North Pennsylvania Street,
 Indianapolis, IN 46205, US
 BIGLER, Michael, E.,
 3624 Highland Avenue, Redwood City, CA 94062, US
 (74) Leevi Markus

Patendibüroo Käosaar & Co OÜ
Tähe 94, 50107 Tartu, EE
Patendikirjelduse tõlke esitamise kuupäev 16.11.2009

-
- (51) **A61K 47/18 (2006.01)** (10) **E003780**
A61K 38/29 (2006.01)
A61P 19/08 (2006.01)
A61P 19/10 (2006.01)
(11) **EE-EP 1420827 B1**
(30) 17.08.2001, US, 313048 P
(96) 16.08.2002, 02794796.9
(97) 23.09.2009, EP 1420827
(54) 5-CNAC suukaudseks manustamiseks mõeldud
ainena paratüroidhormooni fragmentideks
(73) Novartis AG
Lichtstrasse 35, 4056 Basel, CH
(72) AZRIA, Moise
Bundesplatz 6, CH-4054 Basel, CH
BATEMAN, Simon, David
4 Farrington Lane, Randolph, NJ 07869, US
(74) Leevi Markus
Patendibüroo Käosaar & Co OÜ
Tähe 94, 50107 Tartu, EE
Patendikirjelduse tõlke esitamise kuupäev 21.12.2009

-
- (51) **A61K 47/26 (2006.01)** (10) **E003781**
A61K 31/167 (2006.01)
A61P 23/02 (2006.01)
(11) **EE-EP 1988924 B1**
(30) 16.02.2006, IT, MI20060282
(96) 14.02.2007, 07712215.8
(97) 16.09.2009, EP 1988924
(54) Prilokaiin-HCl-i sisaldav uus stabiilne hüperbaariline
kompositsioon, selle kasutamine intratekaalseks
anesteesiaks ning meetod selle valmistamiseks
(73) Sintetica S.A.
Via Penate, 5, 6850 Mendrisio, CH
(72) MITIDIERI, Augusto
Strecia Di Rossi, I-6922 Morcote, IT
DONATI, Elisabetta
Derta 6, I-22020 Cavallasca, IT
(74) Leevi Markus
Patendibüroo Käosaar & Co OÜ
Tähe 94, 50107 Tartu, EE
Patendikirjelduse tõlke esitamise kuupäev 04.12.2009

-
- (51) **A61K 47/34 (2006.01)** (10) **E003782**
A61K 9/06 (2006.01)
A61K 31/59 (2006.01)
A61K 8/00 (2006.01)
A61K 47/10 (2006.01)
A61K 47/14 (2006.01)
(11) **EE-EP 1893237 B1**
(30) 17.06.2005, FR, 0506183
(96) 15.06.2006, 06778599.8
(97) 16.09.2009, EP 1893237
(54) Farmatseutiline kompositsioon, mis sisaldab organo-
polüsiloksaanelastomeeri ja solubiliseeritud toime-

ainet

- (73) Galderma Research & Development
Les Templiers, 2400 Route des Colles, 06410 Biot,
FR
(72) BARTHEZ, Nathalie
La Valériane 91, avenue des Oliviers,
06700 SAINT LAURENT DU VAR, FR
TONGLET, Emilie
2 place des Arcades, 06250 Mougins Le Haut, FR
ORSONI, Sandrine
Les Jardins de Mandelieu, 522, rue de Boeri,
F-06210 Mandelieu, FR
FREDON, Laurent
Chemin du Camouyer, Lotissement Les Templiers,
Cidex 410 Bis, 06330 Roquefort les Pins, FR
(74) Piret Niidas
OÜ Lasvet
Suurtüki 4a, 10133 Tallinn, EE
Patendikirjelduse tõlke esitamise kuupäev 03.12.2009

-
- (51) **A61K 47/48 (2006.01)** (10) **E003783**
(11) **EE-EP 1463529 B1**
(30) 20.12.2001, CZ, 20014653
(96) 20.12.2002, 02805243.9
(97) 19.08.2009, EP 1463529
(54) Antratsükliini kantserostaatiliste ravimite pH-tund-
likud polümeersed konjugaadid sihipäraseks raviks
(73) Zentiva, k.s.
U kabelovny 130, Dolni Mecholupy, 102 37 Praha
10, CZ
(72) ULBRICH, Karel
Horáckova 8, 140 00 Prague 4, CZ
ETRYCH, Tomáš
Trnkovo nám. 1112/1, 152 00 Praha 5, CZ
RIHOVA, Blanka
Pod Terebkou 11/1136, 140 00 Prague 4, CZ
JELINKOVA, Markéta
Tavolniková 1841, 142 00 Praha 4, CZ
KOVAR, Marek
U zeleného ptáka 1148, 148 00 Praha 4, CZ
(74) Leevi Markus
Patendibüroo Käosaar & Co OÜ
Tähe 94, 50107 Tartu, EE
Patendikirjelduse tõlke esitamise kuupäev 18.11.2009

-
- (51) **A61K 49/04 (2006.01)** (10) **E003784**
(11) **EE-EP 1575621 B1**
(30) 12.12.2002, US, 432879 P
05.11.2003, US, 701586
(96) 07.11.2003, 03786628.2
(97) 04.11.2009, EP 1575621
(54) Parendatud bioloogilise tolerantsusega kontrastaine
formulatsioonid
(73) Biophysica, Inc.
2159 Avenida de la Playa, La Jolla CA 92037, US
(72) SOVAK, Milos Biophysica Research, Inc.
2159 Avenida de la Playa, Suite B,
La Jolla, CA 92037-3215, US
SELIGSON, Allen, L.

17826 Rancho del Sol, Ramona, CA 92065, US
 TERRY, Ronald C.
 4614 Chickasaw Court, San Diego,
 California 92117, US
 (74) Alla Hämmalov
 OÜ Intels
 Riia 11-3, 51010 Tartu, EE
 Patendikirjelduse tõlke esitamise kuupäev 17.11.2009

(51) **A61L 31/10 (2006.01)** (10) **E003785**
A61L 31/16 (2006.01)

(11) **EE-EP 1937328 B1**
 (30) 14.10.2005, US, 251441
 (96) 12.10.2006, 06791282.4
 (97) 26.08.2009, EP 1937328
 (54) Polümeerikate meditsiiniseadmete jaoks
 (73) CV THERAPEUTICS, INC.
 3172 Porter Drive, Palo Alto, CA 94304, US

(72) RYPACEK, Frantisek
 Heyrovsky Sq.2, Prague 16206, CZ
 LAPCIKOVA, Monika
 Heyrovsky Sq.2, Prague 16206, CZ
 MACHOVA, Ludka
 Heyrovsky Sq.2, Prague 16206, CZ
 (74) Tõnu Nelsas
 AAA Patendibüroo OÜ
 Tartu mnt 16, 10117 Tallinn, EE
 Patendikirjelduse tõlke esitamise kuupäev 25.11.2009

(51) **A61M 5/145 (2006.01)** (10) **E003786**

(11) **EE-EP 1465689 B1**
 (30) 18.12.2001, GB, 0130139
 (96) 16.12.2002, 02804960.9
 (97) 02.09.2009, EP 1465689
 (54) Meditsiiniline taimeriga süstimiseseade
 (73) DCA Design International Limited
 19 Church Street, Warwick CV34 4AB, GB
 (72) LANGLEY, Christopher, Nigel
 120 Leicester Lane, Leamington Spa,
 Warwickshire CV32 7HH, GB
 VEASEY, Robert, Frederick
 35 Hitchman Road, Leamington Spa, Warwickshire,
 GB
 WOOLSTON, Robert
 3 Chestnut Grove, Moreton Morrall,
 Warwickshire CV35 9DG, GB
 DAY, Shane, Alistair
 9 Brese Avenue, Warwick CV34 5TS, GB

(74) Riho Pikkor
 Patendibüroo Turvaja OÜ
 Liivalaia 22, 10118 Tallinn, EE
 Patendikirjelduse tõlke esitamise kuupäev 27.11.2009

(51) **A61M 15/00 (2006.01)** (10) **E003787**

(11) **EE-EP 1641508 B1**
 (30) 09.07.2003, IN, MU07002003
 (96) 09.07.2004, 04743323.0
 (97) 26.08.2009, EP 1641508

(54) Mitmeannuseline inhalaator
 (73) Cipla Ltd.
 289, Bellasis Road, Mumbai Central,
 Mumbai 400 008, Maharashtra, IN
 (72) LULLA, Amar
 131 Maker Towers L, 13th Floor, Cuffe Parade,
 Colaba, Mumbai 400 005, Maharashtra, IN
 MALHOTRA, Geena
 4 Anderson House, Opposite Mazgaon Post Office,
 Mazgaon, Mumbai 400 010, Maharashtra, IN
 RAO, Xerxes
 Flat N. 802 Moraba Mansion Plot N. 405, Linking
 Rd, Khar (W), Mumbai 400 052, Maharashtra, IN
 (74) Mart Enn Koppel
 Patendibüroo Koppel OÜ
 Kajaka 4-10, 11317 Tallinn, EE
 Patendikirjelduse tõlke esitamise kuupäev 24.11.2009

(51) **A61P 31/18 (2006.01)** (10) **E003788**

A61K 31/365 (2006.01)
A61K 31/635 (2006.01)
A61K 31/425 (2006.01)
A61K 31/435 (2006.01)
A61K 31/47 (2006.01)
A61K 31/495 (2006.01)
A61K 45/06 (2006.01)
 (11) **EE-EP 1458447 B1**
 (30) 12.12.2001, EP, 01204841
 (96) 12.12.2002, 02793018.9
 (97) 09.09.2009, EP 1458447
 (54) Tsütokroom p₄₅₀ sõltuvate proteaasi inhibiitorite
 kombinatsioon
 (73) Tibotec Pharmaceuticals
 Eastgate Village, Eastgate, Little Island, Co Cork, IE
 (72) VAN DER GEEST, Ronald
 Baronielaan 137A, NL-4818 PD Breda, NL
 STOFFELS, Paul
 Lindendreef 34, B-2320 Hoogstraten, BE
 GROEN, Cornelis
 Vaartweg 36, NL-4713 RA Oudenbosch, NL
 JOCHMANS, Dirk, Edward, Désiré
 Grote Spekstraat 21, B-3020 Herent, BE
 (74) Enn Urgas
 Patendibüroo Turvaja OÜ
 Liivalaia 22, 10118 Tallinn, EE
 Patendikirjelduse tõlke esitamise kuupäev 08.12.2009

(51) **A62C 4/00 (2006.01)** (10) **E003789**

(11) **EE-EP 1631358 B1**
 (30) 06.06.2003, DE, 10326150
 (96) 03.06.2004, 04738609.9
 (97) 02.09.2009, EP 1631358
 (54) Püsiva tulekindlusega leegipüüdja
 (73) Leinemann GmbH & Co. KG
 Industriestrasse 11, 38110 Braunschweig, DE
 (72) LEINEMANN, Christoph
 Myrtenweg 16, 38108 Braunschweig, DE
 (74) Jüri Käosaar
 Patendibüroo Käosaar & Co OÜ

Tähe 94, 50107 Tartu, EE
Patendikirjelduse tõlke esitamise kuupäev 30.11.2009

(51) **A63B 71/12 (2006.01)** (10) **E003790**
A41D 13/00 (2006.01)
A41D 13/015 (2006.01)
A41D 31/00 (2006.01)

(11) **EE-EP 1909928 B1**
(30) 02.08.2005, DE, 102005036170
(96) 17.07.2006, 06762642.4
(97) 23.09.2009, EP 1909928
(54) Säärekaitse
(73) S1Sport International Limited
Armenias 39A, 2003 Nicosia, CY
(72) Scheffer Harald
St. Georgstrasse 60a, 66663 Merzig, DE
(74) Andres Mutt
OÜ Lasvet
Suurtüki 4a, 10133 Tallinn, EE
Patendikirjelduse tõlke esitamise kuupäev 11.12.2009

(51) **B01D 29/00 (2006.01)** (10) **E003791**
C10G 2/00 (2006.01)
B01D 24/00 (2006.01)

(11) **EE-EP 1965885 B1**
(30) 20.12.2005, FR, 0513207
(96) 01.12.2006, 06841856.5
(97) 30.09.2009, EP 1965885
(54) Kolmefaasilises protsessis kasutatav teisese filtrimise seade
(73) Institut Français du Pétrole
1 & 4 Avenue de Bois-Préau,
92852 Rueil Malmaison Cedex, FR
ENI S.p.A.
Piazzale Enrico Mattei 1, 00144 Roma, IT
(72) ROLLAND, Matthieu
764, Route de Lyon, F-69390 Vernaison, FR
BRUNARD, Nathalie
3, rue des Pommiers, F-69630 Chaponost, FR
VIGUIE, Jean-Christophe
51, rue Tête d'Or, 69006 Lyon, FR
(74) Riho Pikkor
Patendibüroo Turvaja OÜ
Liivalaia 22, 10118 Tallinn, EE
Patendikirjelduse tõlke esitamise kuupäev 03.12.2009

(51) **B01D 63/06 (2006.01)** (10) **E003792**
B01D 35/26 (2006.01)
B01D 29/25 (2006.01)
B01D 29/56 (2006.01)

(11) **EE-EP 1752207 B1**
(30) 29.07.2005, FR, 0508131
(96) 05.07.2006, 06116658.3
(97) 16.09.2009, EP 1752207
(54) Filtreerimisseade, milles on ühendatud tsirkulatsioonikontuur ja tsirkulatsioonipump
(73) Société Industrielle de la Vallée de L' Aigues
S.I.V.A.

Z.A. Les Laurons, 26110 Nyons, FR
(72) Lescoche, Philippe
388 Chemin de la Montagne, 84110, FAUCON, FR
(74) Tõnu Nelsas
AAA Patendibüroo OÜ
Tartu mnt 16, 10117 Tallinn, EE
Patendikirjelduse tõlke esitamise kuupäev 02.12.2009

(51) **B01J 20/22 (2006.01)** (10) **E003793**

(11) **EE-EP 1841527 B1**
(30) 25.01.2005, US, 646780 P
(96) 16.12.2005, 05854430.5
(97) 30.09.2009, EP 1841527
(54) Kromatograafilised kandjad
(73) Mallinckrodt Baker, Inc.
222 Red School Lane, Phillipsburg,
New Jersey 08865, US
(72) DEORKAR, Nandu
14 Spruce Street, Cedar Knolls, New Jersey 07927,
US
BUSS, Robert, C.
1138 Loxley Lane, Allentown,
Pennsylvania 18103-4220, US
MLADOSICH, Joseph, M.
87 Gum Street, Nazareth, Pennsylvania 18064, US
BOUIS, Paul, A.
3875 Gloucester Drive, Bethlehem,
Pennsylvania 18020, US
(74) Harald Tehver
Patendibüroo Turvaja OÜ
Liivalaia 22, 10118 Tallinn, EE
Patendikirjelduse tõlke esitamise kuupäev 16.11.2009

(51) **B01J 20/34 (2006.01)** (10) **E003794**

(11) **EE-EP 1861198 B1**
(30) 24.03.2005, GB, 0506041
(96) 21.03.2006, 06726459.8
(97) 23.09.2009, EP 1861198
(54) Väljalahustamismeetod
(73) GE Healthcare Limited
Amersham Place Little Chalfont,
Buckinghamshire HP7 9NA, GB
(72) OSBORN, Nigel John
GE Healthcare Limited, The Grove Centre,
White Lion Road, Amersham,
Buckinghamshire HP7 9LL, GB
GRIGG, Julian
GE Healthcare Limited, The Grove Centre,
White Lion Road, Little Chalfont,
Buckinghamshire HP7 9LL, GB
(74) Enn Urgas
Patendibüroo Turvaja OÜ
Liivalaia 22, 10118 Tallinn, EE
Patendikirjelduse tõlke esitamise kuupäev 14.12.2009

(51) **B08B 9/032 (2006.01)** (10) **E003795**

B67D 1/07 (2006.01)
(11) **EE-EP 1740323 B1**

(30) 12.03.2004, IE, 20040152
 (96) 10.03.2005, 05718811.2
 (97) 24.06.2009, EP 1740323
 (54) Seade ja meetod joogitorude puhastamiseks
 (73) Moore, Gregory
 Bawnbreaky House, Moynalty, Kells,
 County Meath, IE
 (72) MOORE, Gregory
 Bawnbreaky House, Moynalty, Kells,
 County Meath, IE
 DONNELLAN, Clint
 Donore, Kells, County Meath, IE
 (74) Jüri Käosaar
 Patendibüroo Käosaar & Co OÜ
 Tähe 94, 50107 Tartu, EE
 Patendikirjelduse tõlke esitamise kuupäev 23.09.2009

(51) **B21B 1/46 (2006.01)** (10) **E003796**
 (11) **EE-EP 1909980 B1**
 (96) 19.07.2005, 05778845.7
 (97) 09.09.2009, EP 1909980
 (54) Meetod ja sellega seotud seade pikkade terastoodete
 katkematuks valmistamiseks
 (73) ARVEDI, Giovanni
 Via Mercatello, 26, I-26100 Cremona, IT
 (72) ARVEDI, Giovanni
 Via Mercatello, 26, I-25100 Cremona, IT
 (74) Tõnu Nelsas
 AAA Patendibüroo OÜ
 Tartu mnt 16, 10117 Tallinn, EE
 Patendikirjelduse tõlke esitamise kuupäev 20.11.2009

(51) **B21D 31/04 (2006.01)** (10) **E003797**
 (11) **EE-EP 1993754 B1**
 (30) 08.03.2006, DE, 102006010795
 (96) 28.02.2007, 07711713.3
 (97) 16.09.2009, EP 1993754
 (54) Rakis ja metallelementide avardamise meetod
 (73) Protektorwerk Florenz Maisch GmbH & Co. KG
 Viktoriastrasse 58, 76571 Gaggenau, DE
 (72) WILLERSCHEID, Heiner
 Im Silberloch 2, 77886 Lauf, DE
 GASPERINI, Mario
 Almenweg 9, 76571 Gaggenau, DE
 SPISSINGER, Bernd
 Roter Rain 10, 72270 Baiersbronn, DE
 KRETTENAUER, Kilian
 Wieseweg 19, 76571 Gaggenau, DE
 (74) Toom Pungas
 OÜ Synest
 pk 977, 13402 Tallinn, EE
 Patendikirjelduse tõlke esitamise kuupäev 15.12.2009

(51) **B23K 35/14 (2006.01)** (10) **E003798**
B23K 35/26 (2006.01)
 (11) **EE-EP 1623791 B1**
 (30) 03.08.2004, DE, 102004038280
 (96) 27.07.2005, 05076782.1

(97) 14.10.2009, EP 1623791
 (54) Meetod leegerivate komponentide rafineerimiseks ja
 homogeeneks jaotamiseks pehmejoodistes ning eba-
 soovitatavate reaktsioonisaaduste ja räbu kõrvalda-
 miseks nendest peene joodisepulbri valmistamise ajal
 (73) W.C. Heraeus GmbH
 Heraeusstrasse 12 - 14, 63450 Hanau, DE
 (72) Protsch, Walter, Dipl.-Ing.
 Nelkenstr. 7B, 14513 Teltow, DE
 Schulze, Jürgen, Dipl.-Chem
 Patrizierweg 9A, 14480 Potsdam, DE
 (74) Harald Tehver
 Patendibüroo Turvaja OÜ
 Liivalaia 22, 10118 Tallinn, EE
 Patendikirjelduse tõlke esitamise kuupäev 04.01.2010

(51) **B29C 63/26 (2006.01)** (10) **E003799**
B32B 17/02 (2006.01)
B32B 17/04 (2006.01)
B65D 90/04 (2006.01)
C08J 5/08 (2006.01)
 (11) **EE-EP 1952973 B1**
 (30) 02.02.2007, CH, 1772007
 (96) 07.01.2008, 08405003.8
 (97) 12.08.2009, EP 1952973
 (54) Klaaskiudriie ja sellest valmistatud kahekordsete
 seintega mahuti
 (73) OnO Waterprotection GmbH
 Eduard Bodem Gasse 6, 6020 Innsbruck, AT
 (72) Werner Bachmann
 Neuheim 6, 6275 Ballwil, CH
 (74) Raivo Koitel
 Patendi- & Kaubamärgibüroo Koitel OÜ
 Tartu mnt 65, 10115 Tallinn, EE
 Patendikirjelduse tõlke esitamise kuupäev 01.12.2009

(51) **B42C 9/00 (2006.01)** (10) **E003800**
B42D 3/00 (2006.01)
 (11) **EE-EP 1993851 B1**
 (30) 22.03.2006, BE, 200600179
 (96) 14.03.2007, 07733981.0
 (97) 08.07.2009, EP 1993851
 (54) Lahtiste lehtede termilise kokkukõitmise meetod
 (73) Unibind Limited
 Margarita House 15, Them. Dervis Street,
 136 Nicosia, CY
 (72) PELEMAN, Guido
 Jan Van Rijswijcklaan 76, B-2018 Antwerpen, BE
 (74) Jüri Käosaar
 Patendibüroo Käosaar & Co OÜ
 Tähe 94, 50107 Tartu, EE
 Patendikirjelduse tõlke esitamise kuupäev 30.09.2009

(51) **B60C 11/16 (2006.01)** (10) **E003801**
 (11) **EE-EP 1798069 B1**
 (30) 16.12.2005, FI, 20055676
 (96) 13.12.2006, 06125990.9
 (97) 28.10.2009, EP 1798069

- (54) Naastrehvi naast 3 rue Césaire Levillain, 76300 Sotteville les Rouen, FR
- (73) Scason Oy
Silakatu 3b, 20380 Turku, FI
- (72) Hagelin, Pentti
Kidekatu 4, 20780 Kaarina, FI
- (74) Andres Mutt
OÜ Lasvet
Suurtüki 4a, 10133 Tallinn, EE
- Patendikirjelduse tõlke esitamise kuupäev 03.12.2009
-
- (51) **B60J 5/04 (2006.01)** (10) **E003802**
B60J 10/04 (2006.01)
- (11) **EE-EP 1422095 B1**
- (30) 22.11.2002, DE, 20218156 U
- (96) 06.11.2003, 03025287.8
- (97) 30.09.2009, EP 1422095
- (54) Aknašahti kattekonstruktsioon
- (73) Süddeutsche Aluminium Manufaktur GmbH
Kolomanstrasse 16, 89558 Böhmenkirch, DE
- (72) Schabel, Wolfgang
Adlerstrasse 27, 73113 Ottenbach, DE
Binder, Hans
Im Wiesengrund 10, 89558 Böhmenkirch, DE
- (74) Raivo Koitel
Patendi- & Kaubamärgibüroo Koitel OÜ
Tartu mnt 65, 10115 Tallinn, EE
- Patendikirjelduse tõlke esitamise kuupäev 30.12.2009
-
- (51) **B60R 11/02 (2006.01)** (10) **E003803**
- (11) **EE-EP 1740416 B1**
- (30) 16.04.2004, DE, 102004019188
- (96) 15.04.2005, 05729620.4
- (97) 18.11.2009, EP 1740416
- (54) Hoidmiseseadis mobiilse lõppseadme/ekraani mahutamiseks
- (73) Wobben, Aloys
Argestrasse 19, 26607 Aurich, DE
- (72) Wobben, Aloys
Argestrasse 19, 26607 Aurich, DE
- (74) Tarmo Rosman
Rosman ja Partnerid OÜ
pk 652, 12602 Tallinn, EE
- Patendikirjelduse tõlke esitamise kuupäev 23.11.2009
-
- (51) **B61L 1/20 (2006.01)** (10) **E003804**
B61L 1/16 (2006.01)
- (11) **EE-EP 1308365 B1**
- (30) 30.10.2001, FR, 0114061
- (96) 30.10.2002, 02292690.1
- (97) 24.06.2009, EP 1308365
- (54) Seade raudteeveeremi telgede arvutamiseks seotud vigade kõrvaldamiseks, vastav veeremi pöördvanker ja meetod raudteelõigul liikuva veeremi üksusest läbipääsu kontrollimiseks
- (73) Société Nationale des Chemins de Fer Français
34, rue du Commandant René Mouchotte,
75014 Paris, FR
- (72) Tremblais, Michel
-
- (74) Tõnu Nelsas
AAA Patendibüroo OÜ
Tartu mnt 16, 10117 Tallinn, EE
- Patendikirjelduse tõlke esitamise kuupäev 21.09.2009
-
- (51) **B63H 25/38 (2006.01)** (10) **E003805**
B63H 25/52 (2006.01)
B63B 3/40 (2006.01)
- (11) **EE-EP 2033891 B1**
- (30) 05.09.2007, DE, 202007012480 U
- (96) 29.11.2007, 07023105.5
- (97) 28.10.2009, EP 2033891
- (54) Laevarool
- (73) becker marine systems GmbH & Co. KG
Neuländer Kamp 3, 21079 Hamburg, DE
- (72) Kluge, Mathias
Dorotheenstrasse 182 A, 22299 Hamburg, DE
Kuhlmann, Henning
Rackertwiete 7, 22559 Hamburg, DE
- (74) Riho Pikkor
Patendibüroo Turvaja OÜ
Liivalaia 22, 10118 Tallinn, EE
- Patendikirjelduse tõlke esitamise kuupäev 10.11.2009
-
- (51) **B65B 31/02 (2006.01)** (10) **E003806**
B65D 81/20 (2006.01)
- (11) **EE-EP 1935789 B1**
- (30) 22.12.2006, DE, 102006061309
- (96) 10.11.2007, 07021861.5
- (97) 07.10.2009, EP 1935789
- (54) Meetod ning seade toodete hermeetiliseks pakendamiseks
- (73) Jörg von Seggern Maschinenbau GmbH
An der Kolckwiese 10, 26133 Oldenburg, DE
- (72) Seggern, Jörg von
An der Kolckwiese 10, 26133 Oldenburg, DE
- (74) Riho Pikkor
Patendibüroo Turvaja OÜ
Liivalaia 22, 10118 Tallinn, EE
- Patendikirjelduse tõlke esitamise kuupäev 18.12.2009
-
- (51) **B65D 17/50 (2006.01)** (10) **E003807**
- (11) **EE-EP 1945522 B1**
- (30) 20.10.2005, EP, 05405593
- (96) 11.10.2006, 06806178.7
- (97) 16.09.2009, EP 1945522
- (54) Meetod kaanerõngast ja sulgurmembraani sisaldava purgikaane valmistamiseks
- (73) Alcan Technology & Management Ltd.
Badische Bahnhofstrasse 16,
8212 Neuhausen am Rheinfall, CH
- (72) BAUER, Sven
Alpenblick 20, 78256 Steisslingen, DE
DIETRICH, Christoph
Max-Porzig-Strasse 119, 78224 Singen, DE
GEISLER, Reinhart

Am Breitenstein 4, 78244 Gottmadingen, DE
 ZIEGLER, Andreas
 Buechackerstr. 6, 8234 Stetten, CH
 (74) Ljubov Kesselman
 OÜ Kesna
 Tedre 77-52, 10616 Tallinn, EE
 Patendikirjelduse tõlke esitamise kuupäev 15.12.2009

(51) **B65D 71/00 (2006.01)** (10) **E003808**
B26F 1/20 (2006.01)
 (11) **EE-EP 1497198 B1**
 (30) 20.12.2001, EP, 01830790
 (96) 18.12.2002, 02791849.9
 (97) 12.08.2009, EP 1497198
 (54) Pudelite termokahanev kilepakend ja selle pakendi valmistamise protsess
 (73) Cristofani, Alessandro
 Via Bergognone, 31, I-20144 Milano, IT
 (72) Cristofani, Alessandro
 Via Bergognone, 31, I-20144 Milano, IT
 (74) Jüri Käosaar
 Patendibüroo Käosaar & Co OÜ
 Tähe 94, 50107 Tartu, EE
 Patendikirjelduse tõlke esitamise kuupäev 11.11.2009

(51) **B65D 83/14 (2006.01)** (10) **E003809**
B65D 81/26 (2006.01)
 (11) **EE-EP 1843954 B1**
 (30) 11.01.2005, NL, 1027998
 (96) 11.01.2006, 06700424.2
 (97) 16.09.2009, EP 1843954
 (54) Rõhureguleeriseade mahuti jaoks
 (73) Heineken Supply Chain B.V.
 2e Weteringplantsoen 21, 1017 ZD Amsterdam, NL
 (72) WOLTERS, Wolter
 Zuiderkeerkring 39, 2408 MT Alphen a/d Rijn, NL
 VLOOSWIJK, Johannes, Jacobus, Thomas
 Diemerbroek 44a, NL-3464 HS Papekop, NL
 (74) Riho Pikkor
 Patendibüroo Turvaja OÜ
 Liivalaia 22, 10118 Tallinn, EE
 Patendikirjelduse tõlke esitamise kuupäev 24.11.2009

(51) **B65D 85/10 (2006.01)** (10) **E003810**
B65D 77/00 (2006.01)
 (11) **EE-EP 1861324 B1**
 (30) 14.03.2005, EP, 05251520
 (96) 14.03.2006, 06727563.6
 (97) 15.07.2009, EP 1861324
 (54) Pakitud mahuti sildiga
 (73) Philip Morris Products S.A.
 Quai Jeanrenaud 3, 2000 Neuchâtel, CH
 (72) TALLIER, Bernard
 Chemin du signal 11, CH-2016 Cortaillod, CH
 (74) Toom Pungas
 OÜ Synest
 pk 977, 13402 Tallinn, EE
 Patendikirjelduse tõlke esitamise kuupäev 15.10.2009

(51) **B65H 75/44 (2006.01)** (10) **E003811**
 (11) **EE-EP 2021269 B1**
 (30) 31.03.2006, IT, MI20060622
 (96) 27.03.2007, 07727392.8
 (97) 30.09.2009, EP 2021269
 (54) Elastne tagasikeriv voolikutrummel koos automaatse pidurdusseadmega
 (73) CLABER S.P.A.
 Via Pontebbana, 22, 33080 Fiume Veneto (PN), IT
 (72) ROMAN, Gianfranco
 Via Coletti, 24, I-33087 Pasiano, IT
 (74) Tõnu Nelsas
 AAA Patendibüroo OÜ
 Tartu mnt 16, 10117 Tallinn, EE
 Patendikirjelduse tõlke esitamise kuupäev 20.11.2009

(51) **C01F 17/00 (2006.01)** (10) **E003812**
C09K 3/14 (2006.01)
 (11) **EE-EP 1917214 B1**
 (30) 20.07.2005, AT, 12232005
 (96) 19.07.2006, 06760793.7
 (97) 30.09.2009, EP 1917214
 (54) Tseeriumi baasil põhineva klaasi poleerimise kompositsioon ja meetod selle valmistamiseks
 (73) Treibacher Industrie Aktiengesellschaft
 Auer-Welsbach-Strasse 1, A-9330 Treibach, AT
 (72) SCHERMANZ, Karl
 Buchbergstrasse 15, A-9314 Launsdorf, AT
 SCHÖNFELDER, Johann
 Ringstrasse 10, A-9330 Althofen, AT
 (74) Raivo Koitel
 Patendi- & Kaubamärgibüroo Koitel OÜ
 Tartu mnt 65, 10115 Tallinn, EE
 Patendikirjelduse tõlke esitamise kuupäev 30.12.2009

(51) **C07C 51/09 (2006.01)** (10) **E003813**
C07C 57/38 (2006.01)
C07C 57/58 (2006.01)
C07C 59/64 (2006.01)
C07D 257/04 (2006.01)
A61K 31/192 (2006.01)
A61P 25/28 (2006.01)
 (11) **EE-EP 1847524 B1**
 (96) 21.04.2006, 06112934.2
 (97) 14.10.2009, EP 1847524
 (54) Terfenüüli derivaadid Alzheimeri tõve raviks
 (73) Cellzome Limited
 Chesterford Research Park Little Chesterford,
 Cambridgeshire CB10 1XL, GB
 (72) Wilson, Francis
 71 Moorlands, Welwin Garden City,
 Herts. AL7 4QJ, GB
 Reid, Alison
 Marlborough House 60 High Street,
 Cottenham CB4 8SA, GB
 Reader, Valerie
 5 Coles Lane, Linton, Cambridge CB1 6JS, GB
 Harrison, Richard, John
 5 Saffron Court Station Rd., Saffron Walden,
 Essex CB11 3HB, GB

Sunose, Mihiro
33 Brewery Road, Pampisford Cambridge CB2 4EN,
GB
Hernandez-Perni, Remedios
7 Astley Grove, Stalybridge, Cheshire SK15 1NL,
GB
Major, Jeremy
10 Cigwell Court, Cambridge CB5 8TY, GB
Boussard, Cyrille
44 Harvey Way, Saffron Walden, Essex CB10 2AP,
GB
Smelt, Kathryn
25 Rosebery Court Rosebery Avenue,
London EC1R 5HP, GB
Le Formal, Adeline
14 Ozier Court, Saffron Walden CB11 4BH, GB
Cansfield, Andrew
4 The Limes, Harston, Cambridge CB2 5QT, GB
Burckhardt, Svenja
2 Grapevine Cottages Boxworth,
Cambridge CB3 8NG, GB
Taylor, Jess
12 The Coppens, Stotfold, Hitchin,
Hertfordshire SG5 4PJ, GB
(74) Enn Urgas
Patendibüroo Turvaja OÜ
Liivalaia 22, 10118 Tallinn, EE
Patendikirjelduse tõlke esitamise kuupäev 18.12.2009

(51) **C07C 213/08 (2006.01)** (10) **E003814**
(11) **EE-EP 1852415 B1**
(30) 09.07.2002, EP, 02015229
(96) 09.07.2003, 07015051.1
(97) 07.10.2009, EP 1852415
(54) Meetod *N*-monoasendatud β -aminoalkoholide
valmistamiseks
(73) Lonza AG
Münchensteinerstrasse 38, 4052 Basel, CH
(72) Michel, Dominique, Dr.
Rue du Stade 22, 3960 Sierre, CH
(74) Raivo Koitel
Patendi- & Kaubamärgibüroo Koitel OÜ
Tartu mnt 65, 10115 Tallinn, EE
Patendikirjelduse tõlke esitamise kuupäev 31.12.2009

(51) **C07C 227/16 (2006.01)** (10) **E003815**
C07C 229/26 (2006.01)
C07F 9/54 (2006.01)
(11) **EE-EP 1581475 B1**
(30) 08.01.2003, US, 338045
25.02.2003, US, 372627
(96) 19.12.2003, 03786222.4
(97) 16.09.2009, EP 1581475
(54) (*R*)- ja (*S*)-aminokarnitiini ning nende derivaatide
süntees *D*- ja *L*-asparagiinhapest
(73) SIGMA-TAU Industrie Farmaceutiche Riunite
S.p.A.
Viale Shakespeare, 47, 00144 Roma, IT
(72) GIANNESSI, Fabio

Fabio c/o Sigma-Tau Industrie Farmaceut. Riunite
S.p.A., Via Pontina Km. 30,400, I-00040 Pomezia,
IT
DELL'UOMO, Natalina
c/o Sigma-Tau Industrie Farmaceut. Riunite S.p.A.,
Via Pontina, Km 30,400, I-00040 Pomezia, IT
TINTI, Maria Ornella
c/o Sigma-Tau Industrie Farmaceut. Riunite S.p.A.,
Via Pontina, km 30,400, I-00040 Pomezia, IT
DE ANGELIS, Francesco
c/o Sigma-Tau Industrie Farmaceut. Riunite S.p.A.,
Via Pontina, km 30,400, I-00040 Pomezia, IT
(74) Piret Niidas
OÜ Lasvet
Suurtüki 4a, 10133 Tallinn, EE
Patendikirjelduse tõlke esitamise kuupäev 03.12.2009

(51) **C07C 227/32 (2006.01)** (10) **E003816**
C07C 229/16 (2006.01)
C07D 265/32 (2006.01)
C07C 229/12 (2006.01)
(11) **EE-EP 1362845 B1**
(96) 01.09.2003, 03292145.4
(97) 14.10.2009, EP 1362845
(54) Uus protsess *N*-((*S*)-1-karboksübutüül)-(*S*)-alaniini
estrite sünteesimiseks ning nende estrite kasutamine
perindopriili sünteesis
(73) Les Laboratoires Servier
12, Place de La Défense, 92415 Courbevoie Cedex,
FR
(72) Breard, Fabienne
75, rue de la République, 76140 Petit Quevilly, FR
Fugier, Claude
6, rue Thomas Becket, 76210 Gruchet le Valasse, FR
(74) Juhan Hämmalov
OÜ Intels
Riia 11-3, 51010 Tartu, EE
Patendikirjelduse tõlke esitamise kuupäev 17.12.2009

(51) **C07C 233/18 (2006.01)** (10) **E003817**
A61K 31/165 (2006.01)
A61P 25/00 (2006.01)
A61P 9/00 (2006.01)
A61P 15/00 (2006.01)
A61P 37/02 (2006.01)
A61P 35/00 (2006.01)
(11) **EE-EP 1873140 B1**
(30) 30.06.2006, FR, 0605917
(96) 29.06.2007, 07290819.7
(97) 30.09.2009, EP 1873140
(54) Uued naftaleeni derivaadid, meetod nende valmista-
miseks ja neid sisaldavad farmatseutilised kompos-
itsioonid
(73) Les Laboratoires Servier
12, Place de La Défense, 92415 Courbevoie Cedex,
FR
(72) Yous, Said
Résidence Marthe Alexandre 10, rue Lamartine,
Appt. 12, 59120 Loos, FR

Peres, Basile
 5, rue Pyrène, 09000 Foix, FR
 Sabaouni, Ahmed
 28, rue de Strasbourg, 59280 Armentieres, FR
 Berthelot, Pascal
 12, Mail du Bon Pêcheur, 59320 Haubourdin, FR
 Spedding, Michael
 6, rue Ampère, 78110 Le Vesinet, FR
 Delagrange, Philippe
 23 rue Victor Hugo, 92130 Issy les Moulineaux, FR
 Caignard, Daniel-Henri
 17, avenue des Coteaux, 95000 Boisemont, FR
 Millan, Mark
 19, rue du Président Wilson, 78230 Le Pecq, FR
 (74) Juhan Hämmalov
 OÜ Intels
 Riia 11-3, 51010 Tartu, EE
 Patendikirjelduse tõlke esitamise kuupäev 08.12.2009

(51) **C07C 233/41 (2006.01)** (10) **E003818**
C07D 295/12 (2006.01)
C07C 233/47 (2006.01)
C07D 295/08 (2006.01)
C07D 295/18 (2006.01)
C07C 255/58 (2006.01)
C07D 209/14 (2006.01)
C07D 277/62 (2006.01)
C07D 333/58 (2006.01)
A61K 31/132 (2006.01)
A61K 31/165 (2006.01)
A61K 31/404 (2006.01)
A61K 31/425 (2006.01)
A61P 25/04 (2006.01)
 (11) **EE-EP 1745010 B1**
 (30) 10.05.2004, DE, 102004023522
 (96) 06.05.2005, 05739598.0
 (97) 05.08.2009, EP 1745010
 (54) Asendatud tsükloheksüül-1,4-diamiini derivaadid
 (73) Grünenthal GmbH
 Zieglerstrasse 6, 52078 Aachen, DE
 (72) SUNDERMANN, Corinna
 Alte Vaalser Strasse 40 b, 52074 Aachen, DE
 SUNDERMANN, Bernd
 Alte Vaalser Strasse 40 b, 52074 Aachen, DE
 (74) Ljubov Kesselman
 OÜ Kesna
 Tedre 77-52, 10616 Tallinn, EE
 Patendikirjelduse tõlke esitamise kuupäev 30.12.2009

(51) **C07C 309/65 (2006.01)** (10) **E003819**
C07D 295/12 (2006.01)
C07D 277/46 (2006.01)
A61K 31/255 (2006.01)
A61P 11/00 (2006.01)
 (11) **EE-EP 1776336 B1**
 (30) 23.03.2004, EP, 04101202
 (96) 21.03.2005, 05729779.8
 (97) 30.09.2009, EP 1776336
 (54) 2-fenüülpropioonhappe derivaadid ja neid sisaldavad

ravimkompositsioonid
 (73) Dompe` S.P.A.
 Località Campo di Pile sne, 67100 L'Aquila, IT
 (72) ALLEGRETTI, Marcello
 Dompé S.P.A., Via Campo di Pile,
 I-67100 L'Aquila, IT
 BERTINI, Riccardo
 Dompé S.P.A., Via Campo di Pile,
 I-67100 L'Aquila, IT
 CESTA, Maria Candida
 Dompé S.P.A., Via Campo di Pile,
 I-67100 L'Aquila, IT
 MOSCA, Marco
 Dompé S.P.A., Via Campo di Pile,
 I-67100 L'Aquila, IT
 COLOTTA, Francesco
 Dompé S.P.A., Via Campo di Pile,
 I-67100 L'Aquila, IT
 (74) Enn Urgas
 Patendibüroo Turvaja OÜ
 Liivalaia 22, 10118 Tallinn, EE
 Patendikirjelduse tõlke esitamise kuupäev 10.12.2009

(51) **C07D 209/30 (2006.01)** (10) **E003820**
C07D 209/42 (2006.01)
A61K 31/405 (2006.01)
A61P 11/00 (2006.01)
A61P 37/00 (2006.01)
 (11) **EE-EP 1856045 B1**
 (30) 11.03.2005, GB, 0505048
 (96) 10.03.2006, 06726357.4
 (97) 09.09.2009, EP 1856045
 (54) PGD₂ suhtes antagonistliku toimega indool-1-
 äädikhappe derivaadid
 (73) Oxagen Limited
 91 Milton Park, Abingdon, Oxfordshire OX14 4RY,
 GB
 (72) ARMER, Richard, Edward
 91 Milton Park, Abingdon, Oxfordshire OX14 4RY,
 GB
 BOYD, Edward, Andrew
 Evotec OAI, 151 Milton Park, Abingdon,
 Oxon OX14 4RY, GB
 HAY, Philip, Andrew
 Evotec OAI, 151 Milton Park, Abingdon,
 Oxon OX14 4RY, GB
 (74) Leevi Markus
 Patendibüroo Käosaar & Co OÜ
 Tähe 94, 50107 Tartu, EE
 Patendikirjelduse tõlke esitamise kuupäev 08.12.2009

(51) **C07D 211/20 (2006.01)** (10) **E003821**
C07D 211/70 (2006.01)
C07D 243/08 (2006.01)
C07D 295/08 (2006.01)
 (11) **EE-EP 1749818 B1**
 (30) 04.10.2001, DK, 200101466
 (96) 02.10.2002, 06016609.7
 (97) 02.09.2009, EP 1749818

- (54) Fenüülpiperidiini derivaadid kui serotoniini tagasihaarde inhibiitorid
- (73) H. LUNDBECK A/S
Ottiliavej 9, 2500 Valby-Copenhagen, DK
- (72) Ruhland, Thomas
Mollehusene 15, 4000 Roskilde, DK
Smith, Garrick Paul
Aeblehaven 10, 2500 Valby, DK
Bang-Andersen, Benny
Lillegrund 33, 2300 Copenhagen S, DK
Püschl, Ask
Aksel Mollers Have 2, 4th, 2000 Frederiksberg, DK
Moltzen, Einer Knud
Toftekaersvej 29, 2820 Gentofte, DK
Andersen, Kim
744 Fernwood, Ct, Ridgewood, NJ07450, US
- (74) Tõnu Nelsas
AAA Patendibüroo OÜ
Tartu mnt 16, 10117 Tallinn, EE
- Patendikirjelduse tõlke esitamise kuupäev 30.11.2009

- (51) **C07D 211/90 (2006.01)** (10) **E003822**
A61K 31/44 (2006.01)
A61P 9/12 (2006.01)
- (11) **EE-EP 1600441 B1**
- (30) 06.08.2001, IT, MI20011726
- (96) 05.08.2002, 05106264.4
- (97) 30.12.2009, EP 1600441
- (54) Lerkanidipiinvesinikkloriidi kristalne vorm kasutamiseks antihüpertensiivse toimeainena
- (73) Recordati Ireland Limited
Raheens East Ringaskiddy, County Cork, IE
- (72) Bonifacio, Fausto
Via Guido d'Arezzo, 9, 04100 Latina, IT
Campana, Francesco
Via Mediana, 142, 00040 Rocca Priora, IT
De Iasi, Gianluca
Via dei Bersaglieri, 27/A, 04011 Aprilia, IT
Leonardi, Amedeo
Via Poliziano Angelo, 16, 20154 Milano, IT
- (74) Leevi Markus
Patendibüroo Käosaar & Co OÜ
Tähe 94, 50107 Tartu, EE
- Patendikirjelduse tõlke esitamise kuupäev 07.01.2010

- (51) **C07D 215/56 (2006.01)** (10) **E003823**
C07D 401/06 (2006.01)
C07D 409/06 (2006.01)
C07D 417/06 (2006.01)
C07D 471/04 (2006.01)
A61K 31/47 (2006.01)
A61K 31/4709 (2006.01)
A61K 31/5377 (2006.01)
A61K 31/4375 (2006.01)
A61P 31/12 (2006.01)
A61P 31/18 (2006.01)
A61P 43/00 (2006.01)
- (11) **EE-EP 1564210 B1**
- (30) 20.11.2002, JP, 2002336843

- 11.03.2003, JP, 2003065807
16.05.2003, JP, 2003139616
- (96) 20.11.2003, 03811532.5
- (97) 16.09.2009, EP 1564210
- (54) 4-oksokinoliinühendid ja nende kasutamine HIV integraasi inhibiitoritena
- (73) Japan Tobacco Inc.
2-1, Toranomom 2-chome, Minato-ku,
Tokyo 105-8422, JP
- (72) SATOH, Motohide
Japan Tobacco Inc. Central Pharm. Research Inst.,
1-1, Murasaki-cho, Takatsuki-shi, Osaka 569-1125, JP
KAWAKAMI, Hiroshi
Japan Tobacco Inc. Central Pharm. Research Inst.,
1-1, Murasaki-cho, Takatsuki-shi, Osaka 569-1125, JP
ITO, Yoshiharu
Japan Tobacco Inc. Central Pharm. Research Inst.,
1-1, Murasaki-cho, Takatsuki-shi, Osaka 569-1125, JP
SHINKAI, Hisashi
Japan Tobacco Inc. Central Pharm. Resrach Inst.,
1-1, Murasaki-cho, Takatsuki-shi, Osaka 569-1125, JP
MOTOMURA, Takahisa
Japan Tobacco Inc. Central Pharm. Research Inst.,
1-1, Murasaki-cho, Takatsuki-shi, Osaka 569-1125, JP
ARAMAKI, Hisateru
Japan Tobacco Inc. Central Pharm. Research Inst.,
1-1, Murasaki, Takatsuki-shi, Osaka 569-1125, JP
MATSUZAKI, Yuji
Japan Tobacco Inc. Central Pharm. Research Inst.,
1-1, Murasaki-cho, Takatsuki-shi, Osaka 569-1125, JP
WATANABE, Wataru
2nd Dept. of Biochem. School of Pharma. Sciences,
Kyushu Univ. of Health and Welfare, 1714-1,
Yoshino, Nobeoka, Miyazaki, 882-8508, JP
WAMAKI, Shuichi
Japan Tobacco Inc. Central Pharm. Research Inst.,
1-1, Murasaki-cho, Takatsuki-shi, Osaka 569-1125, JP
- (74) Enn Urgas
Patendibüroo Turvaja OÜ
Liivalaia 22, 10118 Tallinn, EE
- Patendikirjelduse tõlke esitamise kuupäev 01.12.2009

- (51) **C07D 217/24 (2006.01)** (10) **E003824**
A61K 31/472 (2006.01)
A61P 25/16 (2006.01)
- (11) **EE-EP 1501804 B1**
- (30) 26.04.2002, EP, 02009253
- (96) 14.04.2003, 03725018.0
- (97) 26.08.2009, EP 1501804
- (54) Isokinoliini derivaadid MAO-B inhibiitoritena
- (73) F. Hoffmann-La Roche AG
Grenzacherstrasse 124, 4070 Basel, CH
- (72) CESURA, Andrea

26, rue du Grand Pré, CH-1299 Crans-près-Celigny, CH
 RODRIGUEZ SARMIENTO, Rosa Maria
 Missionsstrasse 33, CH-4055 Basel, CH
 SCALONE, Michelangelo
 14 Baslerstrasse, CH-4127 Birsfelden, CH
 THOMAS, Andrew, William
 Zwinglistrasse 4, CH-4127 Birsfelden, CH
 WYLER, Rene
 Brandschenkestrasse 168, CH-8002 Zuerich, CH
 (74) Leevi Markus
 Patendibüroo Käosaar & Co OÜ
 Tähe 94, 50107 Tartu, EE
 Patendikirjelduse tõlke esitamise kuupäev 19.11.2009

Malakpet, Hyderabad, Andhra Pradesh 500036, IN
 KHANNA, Mahavir Singh
 C-36A Jitar Nagar, Parwana Road, New Delhi, Delhi 110051, IN
 PRASAD, Mohan
 House No. P-3/3, Phase - II, DLF Qutab Enclave, Gurgaon, Haryana 122001, IN
 KUMAR, Yatendra
 U-26/5, Phase - III, DLF Qutab Enclave, Gurgaon, Haryana 122001, IN
 (74) Enn Urgas
 Patendibüroo Turvaja OÜ
 Liivalaia 22, 10118 Tallinn, EE
 Patendikirjelduse tõlke esitamise kuupäev 03.12.2009

(51) **C07D 223/16 (2006.01)** (10) **E003825**
A61K 31/55 (2006.01)
A61P 3/04 (2006.01)
A61P 25/30 (2006.01)
A61P 25/24 (2006.01)
 (11) **EE-EP 1838677 B1**
 (30) 21.12.2004, US, 638221 P
 (96) 20.12.2005, 05855526.9
 (97) 09.09.2009, EP 1838677
 (54) (R)-8-kloro-1-metüül-2,3,4,5-tetrahydro-1H-3-bensasepiinvesinikkloriidi kristallivormid
 (73) Arena Pharmaceuticals, Inc.
 6166 Nancy Ridge Drive, San Diego, CA 92121, US
 (72) AGARWAL, Rajesh Kumar
 13237 Jacarte Court, San Diego, California 92130, US
 BETTS, III, William L.
 4518 Patria Drive, San Diego, California 92115, US
 HENSHILWOOD, James A.
 2501 Sombrosa Place, Carlsbad, California 92009, US
 KIANG, Yuan-Hon
 3871 Rodene Street, Newbury Park, California 91320, US
 POST, Noah
 3520 Lebon Drive, Apt. 5315, San Diego, California 92122, US
 (74) Piret Niidas
 OÜ Lasvet
 Suurtüki 4a, 10133 Tallinn, EE
 Patendikirjelduse tõlke esitamise kuupäev 30.11.2009

(51) **C07D 239/48 (2006.01)** (10) **E003827**
A61K 31/505 (2006.01)
A61P 35/00 (2006.01)
A61P 31/00 (2006.01)
 (11) **EE-EP 1902037 B1**
 (30) 01.07.2005, EP, 05106007
 (96) 30.06.2006, 06763989.8
 (97) 02.09.2009, EP 1902037
 (54) 2,4-diaminopürimidiinid kui Aurora inhibiitorid
 (73) Boehringer Ingelheim International GmbH
 Binger Strasse 173, 55216 Ingelheim am Rhein, DE
 (72) ZAHN, Stephan Karl
 Speisinger Strasse 113/10, A-1130 Wien, AT
 BOEHMELT, Guido
 Ebenfeldweg 11, A-2531 Gaaden, AT
 MANTOULIDIS, Andreas
 Forsthausgasse 10 Haus A1/Tür 16, A-1200 Wien, DE
 REISER, Ulrich
 Wittegassee 10/14, A-1130 Wien, AT
 TREU, Matthias
 Josefstaedter Strasse 47-49/2/11, A-1080 Wien, AT
 GUERTLER, Ulrich
 Bischoffgasse 14, A-1120 Wien, AT
 SCHOOP, Andreas
 Am Schwaigfeld 17, 82061 Neuried, AT
 SOLCA, Flavio
 Gesslgasse 10/6, A-1230 WIEN, AT
 TONTSCH-GRUNT, Ulrike
 Oetkerweg 23, A-2500 Baden, AT
 BRUECKNER, Ralph
 Gallgasse 68/2, A-1130 Wien, AT
 REITHER, Charlotte
 Ziedlergasse 9/13, A-1230 Wien, AT
 HERFURTH, Lars
 Neugasse 11, 55437 Appenheim, DE
 KRAEMER, Oliver
 Kleine Neugasse 3, A-1050 Wien, AT
 STADTMUELLER, Heinz
 Stachegasse 21/3/29, A-1120 Vienna, AT
 ENGELHARDT, Harald
 Hieronymus von Beck Strasse 27, A-2483 Ebreichsdorf, AT
 (74) Piret Niidas
 OÜ Lasvet

(51) **C07D 235/28 (2006.01)** (10) **E003826**
B01J 21/06 (2006.01)
 (11) **EE-EP 1802584 B1**
 (30) 11.10.2004, IN, DE19572004
 (96) 04.10.2005, 05790107.6
 (97) 16.09.2009, EP 1802584
 (54) Meetod asendatud sulfoksiidide valmistamiseks
 (73) Ranbaxy Laboratories Limited
 Plot No. 90, Sector- 32, Gurgaon, Haryana 122001, IN
 (72) KUMAR, Neela Praveen
 House No. 16-2-705/9/ A/8, Professors Colony,

Suurtüki 4a, 10133 Tallinn, EE
Patendikirjelduse tõlke esitamise kuupäev 20.11.2009

- (51) **C07D 241/20 (2006.01)** (10) **E003828**
C07D 241/18 (2006.01)
C07D 241/26 (2006.01)
C07D 401/12 (2006.01)
C07D 403/12 (2006.01)
C07D 405/12 (2006.01)
C07D 491/04 (2006.01)
C07D 409/12 (2006.01)
C07D 401/04 (2006.01)
C07D 401/14 (2006.01)
A61K 31/4965 (2006.01)
A61P 25/00 (2006.01)
- (11) **EE-EP 1446387 B1**
(30) 21.11.2001, US, 332052 P
21.02.2002, US, 358546 P
13.06.2002, US, 338285 P
13.09.2002, US, 410378 P
(96) 15.11.2002, 02780507.6
(97) 04.11.2009, EP 1446387
(54) Asendatud ariüül-1,4-pürasiinderivaadid
(73) Pharmacia & Upjohn Company LLC
7000 Portage Road, Kalamazoo, MI 49001, US
(72) VERHOEST, Patrick, R.
7150 Pin Oak Circle, Augusta, MI 49012, US
HOFFMAN, Robert, L.
5423 Telluride Drive, Kalamazoo, MI 49009, US
CORBETT, Jeffrey, W.
6427 Pepperidge Circle, Portage, MI 49024, US
ENNIS, Michael, D.
8355 Brandon Circle, Mattawan, MI 49071, US
FRANK, Kristine, E.
8117 Black Forest Drive, Portage, MI 49009, US
FU, Jian-Min
5123 Heathrow Avenue, Kalamazoo, MI 49009, US
(74) Raivo Koitel
Patendi- & Kaubamärgibüroo Koitel OÜ
Tartu mnt 65, 10115 Tallinn, EE
Patendikirjelduse tõlke esitamise kuupäev 18.12.2009

- (51) **C07D 261/20 (2006.01)** (10) **E003829**
C07D 413/04 (2006.01)
C07D 413/12 (2006.01)
A61K 31/423 (2006.01)
A61K 31/4439 (2006.01)
A61P 29/00 (2006.01)
- (11) **EE-EP 1888541 B1**
(30) 18.05.2005, DE, 102005023589
16.08.2005, DE, 102005038947
(96) 18.05.2006, 06742972.0
(97) 05.08.2009, EP 1888541
(54) Benso(D)isoksasool-3-üülamiin-ühendid ja nende kasutamine vanilloid-retseptori ligandidena
(73) Grünenthal GmbH
Zieglerstrasse 6, 52078 Aachen, DE
(72) FRANK, Robert
Luisenstr. 28, 52070 Aachen, DE

MERLA, Beatrix
Bodelschwingstrasse 36, 52078 Aachen, DE
REICH, Melanie
Nizzaallee 39, 52072 Aachen, DE
JOSTOCK, Ruth
Hostetstr. 35, 52223 Stolberg, DE
(74) Ljubov Kesselman
OÜ Kesna
Tedre 77-52, 10616 Tallinn, EE
Patendikirjelduse tõlke esitamise kuupäev 05.01.2010

- (51) **C07D 333/24 (2006.01)** (10) **E003830**
A61P 3/10 (2006.01)
A61K 31/381 (2006.01)
- (11) **EE-EP 1856090 B1**
(30) 11.02.2005, US, 652492 P
(96) 09.02.2006, 06720513.8
(97) 14.10.2009, EP 1856090
(54) Asendatud tiofeeni derivaadid glükagooni retseptori antagonistidena, nende valmistamine ja terapeutiline kasutamine
(73) ELI LILLY AND COMPANY
Lilly Corporate Center, Indianapolis, Indiana 46285, US
(72) CHAPPELL, Mark, Donald
541 Pitney Drive, Noblesville, IN 46060, US
CONNER, Scott, Eugene
8426 Carefree Circle, Indianapolis, Indiana 46236, US
TRIPP, Allie, Edward
219 Byrkit Street, Indianapolis, Indiana 46217, US
ZHU, Guoxin
Shanghai ChemExplorer Co., Ltd., No. 10 Building,
965 Halei Road, Pudong New Area,
Shanghai 201203, CN
(74) Leevi Markus
Patendibüroo Käosaar & Co OÜ
Tähe 94, 50107 Tartu, EE
Patendikirjelduse tõlke esitamise kuupäev 10.12.2009

- (51) **C07D 401/04 (2006.01)** (10) **E003831**
A61K 31/415 (2006.01)
A61P 35/00 (2006.01)
- (11) **EE-EP 1594858 B1**
(30) 28.08.2002, US, 406524 P
08.10.2002, US, 417047 P
(96) 14.08.2003, 03791110.4
(97) 14.10.2009, EP 1594858
(54) Antiproliferatiivsete ainetena kasulikud uued bensoimidiasooli derivaadid
(73) Pfizer Products Inc.
Eastern Point Road, Groton, Connecticut 06340, US
(72) KATH, John, Charles
Pfizer Global Res. and Dev., Eastern Point Road,
Groton, CT 06340, US
LYSSIKATOS, Joseph, Peter
23 Estrella Avenue, Piedmont, CA 94611, US
WANG, Huifen, Faye
Pfizer Global Research and Development, Groton,

(74) CT 06340, US
Raivo Koitel
Patendi- & Kaubamärgibüroo Koitel OÜ
Tartu mnt 65, 10115 Tallinn, EE
Patendikirjelduse tõlke esitamise kuupäev 01.12.2009

(51) **C07D 401/12 (2006.01)** (10) **E003832**
C07D 401/14 (2006.01)
C07D 413/14 (2006.01)
A61K 31/506 (2006.01)
A61K 31/4545 (2006.01)
A61P 3/00 (2006.01)
(11) **EE-EP 1911756 B1**
(30) 10.01.2005, US, 642840 P
(96) 09.01.2006, 07023528.8
(97) 21.10.2009, EP 1911756
(54) Asendatud püridinüül- ja pürimidinüül-derivaadid kui metabolismi ja sellega seotud haiguste ravi modulaatorid
(73) Arena Pharmaceuticals, Inc.
6166 Nancy Ridge Drive, San Diego, CA 92121, US
(72) Hurst, David
8082 Rancho Fanita Drive, Santee, California 92071, US
Jones, Robert M.
10937 Corte Luz Del Sol, San Diego, California 92130, US
Wong, Amy Siu-Ting
12956 Cree Drive, Poway, CA 92064, US
Lehmann, Juerg
9840 La Tortola Court, San Diego, California 92129, US
Shin, Young-jun
11051 Ice Skate Place, San Diego, California 92126, US
(74) Piret Niidas
OÜ Lasvet
Suurtüki 4a, 10133 Tallinn, EE
Patendikirjelduse tõlke esitamise kuupäev 06.01.2010

(51) **C07D 407/04 (2006.01)** (10) **E003833**
A61K 8/49 (2006.01)
A61Q 19/08 (2006.01)
(11) **EE-EP 1690862 B1**
(30) 03.02.2005, IT, MI20050151
(96) 02.02.2006, 06101214.2
(97) 08.07.2009, EP 1690862
(54) Sorbitüül-furfuraali rasvhapete monoestrid ning vastavad kosmeetilistel ja dermatoloogilistel eesmärkidel kasutatavad kompositsioonid
(73) Giuliani S.p.A.
Via Palagi, 2, 20129 Milano, IT
(72) Bertelli, Vittorio
Via Garibaldi 33, 20048 Carate Brianza, IT
(74) Leevi Markus
Patendibüroo Käosaar & Co OÜ
Tähe 94, 50107 Tartu, EE
Patendikirjelduse tõlke esitamise kuupäev 06.10.2009

(51) **C07D 417/14 (2006.01)** (10) **E003834**
C07D 417/12 (2006.01)
C07D 413/12 (2006.01)
A61K 31/428 (2006.01)
A61P 35/00 (2006.01)
A61P 37/00 (2006.01)
A61P 29/00 (2006.01)
(11) **EE-EP 1831209 B1**
(30) 17.12.2004, FR, 0413456
(96) 16.12.2005, 05826562.0
(97) 12.08.2009, EP 1831209
(54) Cdc25 fosfataaside inhibiitorid
(73) IPSEN PHARMA
65 Quai Georges Gorse,
92100 Boulogne-Billancourt, FR
(72) SIDHU, Alban
2, allée Jacques Anquetil, F-91070 Bondoufle, FR
PREVOST, Grégoire
19 rue Voltaire, 92160 ANTONY, FR
BIGG, Dennis
15 rue Juliette Adam Bât.A,
F-91190 GIF SUR YVETTE, FR
GALCERA CONTOUR, Marie-Odile
2, allée Jacques Anquetil, F-91070 BONDOUFLE, FR
(74) Piret Niidas
OÜ Lasvet
Suurtüki 4a, 10133 Tallinn, EE
Patendikirjelduse tõlke esitamise kuupäev 17.12.2009

(51) **C07D 453/02 (2006.01)** (10) **E003835**
C07D 519/00 (2006.01)
A61K 31/5365 (2006.01)
A61P 11/06 (2006.01)
(11) **EE-EP 1631569 B1**
(30) 02.05.2003, GB, 0310232
24.10.2003, GB, 0324887
(96) 30.04.2004, 04730519.8
(97) 26.08.2009, EP 1631569
(54) Muskariini M₃ retseptoritega seotud kinokliidiini derivaadid
(73) Novartis AG
Lichtstrasse 35, 4056 Basel, CH
(72) Collingwood, Stephen Paul
Novartis Horsham Research Centre, Wimblerhurst Road, Horsham, West Sussex RH12 5AB, GB
Cox, Brian
Novartis Horsham Research Centre, Wimblerhurst Road, Horsham, West Sussex RH12 5AB, GB
Baettig, Urs
Novartis Horsham Research Centre, Wimblerhurst Road, Horsham, West Sussex RH12 5AB, GB
Bhalay, Gurdip
Novartis Horsham Research Centre, Wimblerhurst Road, Horsham, West Sussex RH12 5AB, GB
Devereux, Nicholas James
Novartis Horsham Research Centre, Wimblerhurst Road, Horsham, West Sussex RH12 5AB, GB
(74) Leevi Markus
Patendibüroo Käosaar & Co OÜ
Tähe 94, 50107 Tartu, EE

Patendikirjelduse tõlke esitamise kuupäev 23.11.2009

- (51) **C07D 471/04 (2006.01)** (10) **E003836**
A61K 31/437 (2006.01)
A61P 25/00 (2006.01)
- (11) **EE-EP 1869038 B1**
(30) 08.04.2005, DE, 102005016547
(96) 07.04.2006, 06724098.6
(97) 08.07.2009, EP 1869038
(54) Asendatud 5,6,7,8-tetrahydro-imidaso(1,2-a) püridiin-2-üülamiin-ühendid ja nende kasutamine ravimite valmistamiseks
- (73) Grünenthal GmbH
Zieglerstrasse 6, 52078 Aachen, DE
- (72) FRANK, Robert
Luisenstr. 28, 52070 Aachen, DE
SUNDERMANN, Bernd
Alte Vaalser Str. 40b, 52074 Aachen, DE
SUNDERMANN, Corinna
Alte Vaalser Str. 40b, 52074 Aachen, DE
- (74) Ljubov Kesselman
OÜ Kesna
Tedre 77-52, 10616 Tallinn, EE

Patendikirjelduse tõlke esitamise kuupäev 07.12.2009

- (51) **C07D 471/04 (2006.01)** (10) **E003837**
A61K 31/437 (2006.01)
A61P 25/24 (2006.01)
- (11) **EE-EP 1730144 B1**
(30) 22.03.2004, DE, 102004014304
(96) 22.03.2005, 05716300.8
(97) 10.06.2009, EP 1730144
(54) Asendatud 1,4,8-triasaspiro[4,5]dekaan-2-oon-ühendid
- (73) Grünenthal GmbH
Zieglerstrasse 6, 52078 Aachen, DE
- (72) SUNDERMANN, Corinna
Alte Vaalser Str. 40b, 52074 Aachen, DE
SUNDERMANN, Bernd
Alte Vaalser Str. 40b, 52074 Aachen, DE
OBERBÖRSCH, Stefan
Weidenweg 10, 52074 Aachen, DE
ENGLBERGER, Werner
Sonnenweg 1, 52223 Stolberg, DE
HENNIES, Hagen-Heinrich
Eicherscheid 56, 52152 Simmerath, DE
- (74) Ljubov Kesselman
OÜ Kesna
Tedre 77-52, 10616 Tallinn, EE

Patendikirjelduse tõlke esitamise kuupäev 09.11.2009

- (51) **C07D 471/04 (2006.01)** (10) **E003838**
A61K 31/437 (2006.01)
A61P 29/00 (2006.01)
A61P 11/00 (2006.01)
- (11) **EE-EP 1539753 B1**
(30) 16.09.2002, GB, 0221455
23.12.2002, GB, 0230045

21.03.2003, GB, 0306595

07.04.2003, GB, 0308017

21.08.2003, GB, 0319708

09.09.2003, GB, 0321074

(96) 12.09.2003, 03778283.6

(97) 09.09.2009, EP 1539753

(54) Pürasolo(3,4-b)püridiinühendid ja nende kasutamine fosfodiesteri inhiibitoritena

(73) GLAXO GROUP LIMITED

Glaxo Wellcome House, Berkeley Avenue
Greenford, Middlesex UB6 0NN, GB

(72) ALLEN, David, George

GlaxoSmithKline, Gunnels Wood Road, Stevenage,
Hertfordshire SG1 2NY, GB

COE, Diane, Mary

GlaxoSmithKline, Gunnels Wood Road, Stevenage,
Hertfordshire SG1 2NY, GB

COOK, Caroline, Mary

GlaxoSmithKline, Gunnels Wood Road, Stevenage,
Hertfordshire SG1 2NY, GB

DOWLE, Michael, Dennis

c/o GlaxoSmithKline, Gunnels Wood Road,
Stevenage, Hertfordshire SG1 2NY, GB

EDLIN, Christopher, David

c/o GlaxoSmithKline, Gunnels Wood Road,
Stevenage, Hertfordshire SG1 2NY, GB

HAMBLIN, Julie, Nicole

GlaxoSmithKline, Gunnels Wood Road, Stevenage,
Hertfordshire SG1 2NY, GB

JOHNSON, Martin, Redpath

c/o GlaxoSmithKline, Gunnels Wood Road,
Stevenage, Hertfordshire SG1 2NY, GB

JONES, Paul, Spencer

GlaxoSmithKline, Gunnels Wood Road, Stevenage,
Hertfordshire SG1 2NY, GB

KNOWLES, Richard, Graham

GlaxoSmithKline, Gunnels Wood Road, Stevenage,
Hertfordshire SG1 2NY, GB

LINDVALL, Mika, Kristian

c/o GlaxoSmithKline, Gunnels Wood Road,
Stevenage, Hertfordshire SG1 2NY, GB

MITCHELL, Charlotte, Jane

GlaxoSmithKline, Gunnels Wood Road, Stevenage,
Hertfordshire SG1 2NY, GB

REDGRAVE, Alison, Judith

GlaxoSmithKline, Gunnels Wood Road, Stevenage,
Hertfordshire SG1 2NY, GB

WARD, Peter

c/o GlaxoSmithKline, Gunnels Wood Road,
Stevenage, Hertfordshire SG1 2NY, GB

(74) Leevi Markus

Patendibüroo Käosaar & Co OÜ

Tähe 94, 50107 Tartu, EE

Patendikirjelduse tõlke esitamise kuupäev 30.11.2009

(51) **C07D 471/04 (2006.01)** (10) **E003839**
A61K 31/4709 (2006.01)
A61P 31/04 (2006.01)

(11) **EE-EP 1737859 B1**

(30) 01.04.2004, DE, 102004015981

- (96) 19.03.2005, 05716236.4
 (97) 02.12.2009, EP 1737859
 (54) 8-tsüano-1-tsüklopropüül-7-(1S,6S-2,8-diasabi-
 tsüklo[4.3.0]nonaan-8-üül)-6-fluoro-1,4-dihüdro-4-
 okso-3-kinoliinkarboksüülhappe uus kristallivorm
 (73) Bayer Animal Health GmbH
 51368 Leverkusen, DE
 (72) RAST, Hubert
 Auf dem Bruch 77a, 51381 Leverkusen, DE
 HEEP, Iris
 Grüner Weg 7a, 50859 Köln, DE
 GRUNENBERG, Alfons
 Gneisenastr. 15, 41539 Dormagen, DE
 HALLENBACH, Werner
 Lichtenbergerstr. 68, 40789 Monheim, DE
 BENET-BUCHHOLZ, Jordi
 Placa Romani 3A, 43893 Altafulla, ES
 (74) Piret Niidas
 OÜ Lasvet
 Suurtüki 4a, 10133 Tallinn, EE
 Patendikirjelduse tõlke esitamise kuupäev 17.12.2009

- (51) **C07D 471/04 (2006.01)** (10) **E003840**
C07D 487/04 (2006.01)
A61K 31/498 (2006.01)
A61P 35/00 (2006.01)
 (11) **EE-EP 1953161 B1**
 (30) 02.02.2007, FR, 0700741
 (96) 01.02.2008, 08290088.7
 (97) 26.08.2009, EP 1953161
 (54) Uued tritsükliised derivaadid, meetod nende
 valmistamiseks ning neid sisaldavad farmatseutilised
 kompositsioonid
 (73) Les Laboratoires Servier
 12, Place de La Défense, 92415 Courbevoie Cedex,
 FR
 (72) Casara, Patrick
 740, Chemin Pré Seigneur,
 78670 Villennes sur Seine, FR
 Le Diguarher, Thierry
 2, rue Jean de la Fontaine, 92500 Rueil Malmaison,
 FR
 Geneste, Olivier
 Bâtiment A 17 rue Crevel Duval,
 92500 Rueil Malmaison, FR
 Hickman, John
 126, boulevard Pereire, 75017 Paris, FR
 (74) Juhan Hämmalov
 OÜ Intels
 Riia 11-3, 51010 Tartu, EE
 Patendikirjelduse tõlke esitamise kuupäev 25.11.2009

- (51) **C07D 471/18 (2006.01)** (10) **E003841**
A61K 31/439 (2006.01)
A61P 25/00 (2006.01)
 (11) **EE-EP 1915375 B1**
 (30) 12.08.2005, FR, 0508528
 (96) 07.08.2006, 06794298.7
 (97) 07.10.2009, EP 1915375

- (54) 5-püridinüül-1-asabitsüklo[3.2.1]oktaani derivaadid,
 nende valmistamismeetod ja kasutamine ravis
 (73) Sanofi-Aventis
 174, Avenue de France, 75013 Paris, FR
 (72) GALLI, Frédéric
 6 avenue de Rueil, F-92420 Vaucresson, FR
 LECLERC, Odile
 11 rue Winston Churchill, F-91300 Massy, FR
 LOCHEAD, Alistair
 95 rue de Paris, F-94220 Charenton le Pont, FR
 VACHE, Julien
 2 Rue Du Grand Prieuré, F-75011 Paris, FR
 (74) Enn Urgas
 Patendibüroo Turvaja OÜ
 Liivalaia 22, 10118 Tallinn, EE
 Patendikirjelduse tõlke esitamise kuupäev 10.12.2009

- (51) **C07D 491/22 (2006.01)** (10) **E003842**
A61K 31/4375 (2006.01)
A61P 35/00 (2006.01)
A61P 31/12 (2006.01)
A61P 33/00 (2006.01)
 (11) **EE-EP 1509529 B1**
 (30) 31.05.2002, IT, RM20020306
 (96) 28.05.2003, 03730481.3
 (97) 12.08.2009, EP 1509529
 (54) Kamptotetsiini estrid 20 positsioonis
 (73) SIGMA-TAU Industrie Farmaceutiche Riunite
 S.p.A.
 Viale Shakespeare, 47, 00144 Roma, IT
 ISTITUTO NAZIONALE PER LO STUDIO E LA
 CURA DEI TUMORI
 Via Venezian, 1, I-20133 Milano, IT
 (72) MARZI, Mauro
 Sigma-Tau Ind. Farmac. Riunite, Via Pontina,
 Km 3400, I-00040 Pomezia, IT
 ALLOATTI, Domenico
 Sigma-Tau Ind. Farmac. Riunite, Via Pontina,
 Km 30400, I-00040 Pomezia, IT
 PISANO, Claudio
 Sigma-Tau Ind. Farmac. Riunite, Via Pontina,
 Km 30400, I-00040 Pomezia, IT
 TINTI, Maria Ornella
 Sigma-Tau Ind. Farmac. Riunite, Via Pontina,
 Km 30400, I-00040 Pomezia, IT
 VESCI, Loredana
 Sigma-Tau Ind. Farmac. Riunite SPA, Via Pontina,
 Km 30400, I-00040 Pomezia, IT
 ZUNINO, Franco
 Ist.N. per lo Studio e la Cura Tumo,
 Via Venezian, 1, I-20133 Milano, IT
 (74) Leevi Markus
 Patendibüroo Käosaar & Co OÜ
 Tähe 94, 50107 Tartu, EE
 Patendikirjelduse tõlke esitamise kuupäev 06.11.2009

- (51) **C07D 491/22 (2006.01)** (10) **E003843**
C07D 471/14 (2006.01)
A61K 31/4745 (2006.01)

- (11) **EE-EP 1910376 B1**
 (30) 05.08.2005, FR, 0508365
 (96) 04.08.2006, 06794287.0
 (97) 30.09.2009, EP 1910376
 (54) Uued kamptotetsiini analoogühendid, meetod nende valmistamiseks ja neid sisaldavad farmatseutilised kompositsioonid
 (73) Les Laboratoires Servier
 12, Place de La Défense, 92415 Courbevoie Cedex, FR
 (72) LAVIELLE, Gilbert
 1, avenue Lily, F-78170 La Celle Saint Cloud, FR
 HAUTEFAYE, Patrick
 9, rue du Pré aux Moutons,
 F-77170 Servon Brie Comte Robert, FR
 PIERRE, Alain
 9 Chemin des Bois Janeaudes,
 F-78580 Les Alluets le Roi, FR
 HICKMAN, John
 126, boulevard Péreire, F-75017 Paris, FR
 LEONCE, Stéphane
 28C, rue Henri Simon, F-78000 Versailles, FR
 (74) Juhan Hämmalov
 OÜ Intels
 Riia 11-3, 51010 Tartu, EE
 Patendikirjelduse tõlke esitamise kuupäev 17.12.2009

- (51) **C07D 501/56 (2006.01)** (10) **E003844**
A61K 31/545 (2006.01)
A61K 31/04 (2006.01)
 (11) **EE-EP 1606293 B1**
 (30) 27.03.2003, EP, 03006815
 (96) 15.03.2004, 04720595.0
 (97) 19.08.2009, EP 1606293
 (54) Tsefalosporiini kristalne vorm
 (73) Basilea Pharmaceutica AG
 Grenzacherstrasse 487, 4058 Basel, CH
 (72) BERGHAUSEN, Joerg
 Eckenbachweg 17, 79541 Lörrach, DE
 (74) Leevi Markus
 Patendibüroo Käosaar & Co OÜ
 Tähe 94, 50107 Tartu, EE
 Patendikirjelduse tõlke esitamise kuupäev 12.11.2009

- (51) **C07F 5/02 (2006.01)** (10) **E003845**
 (11) **EE-EP 1893622 B1**
 (30) 13.06.2005, US, 690113 P
 (96) 09.06.2006, 06763613.4
 (97) 02.09.2009, EP 1893622
 (54) Meetod dialkoksüorganoboraanide sünteesiks
 (73) BASF SE
 67056 Ludwigshafen, DE
 (72) BURKHARDT, Elizabeth
 1025 Lakemont Drive, 15017 Bridgeville, US
 ATKINS, William
 1424 Mars-evans City, 16033 Evans-city,
 Pennsylvania, US
 (74) Leevi Markus
 Patendibüroo Käosaar & Co OÜ

Tähe 94, 50107 Tartu, EE
 Patendikirjelduse tõlke esitamise kuupäev 26.11.2009

- (51) **C07H 21/02 (2006.01)** (10) **E003846**
C07H 21/04 (2006.01)
C07H 21/00 (2006.01)
A01N 43/04 (2006.01)
 (11) **EE-EP 1575977 B1**
 (30) 23.12.2002, US, 436122 P
 13.02.2003, US, 447885 P
 01.05.2003, US, 467546 P
 (96) 18.12.2003, 03814325.1
 (97) 09.09.2009, EP 1575977
 (54) Immunomoduleeriv oligonukleotiidjärjestus ja meetodid selle kasutamiseks
 (73) Dynavax Technologies Corporation
 2929 Seventh Street, Suite 100, Berkeley, CA 94710, US
 (72) DINA, Dino
 6140 Buena Vista Avenue, Oakland, CA 94618, US
 FEARON, Karen, L.
 4064 Valente Court, Lafayette, CA 94549, US
 MARSHALL, Jason
 5733 Fleming Avenue, Oakland, CA 94605, US
 (74) Tõnu Nelsas
 AAA Patendibüroo OÜ
 Tartu mnt 16, 10117 Tallinn, EE
 Patendikirjelduse tõlke esitamise kuupäev 09.12.2009

- (51) **C07J 41/00 (2006.01)** (10) **E003847**
A61K 31/575 (2006.01)
A61P 25/28 (2006.01)
A61P 25/00 (2006.01)
 (11) **EE-EP 1963355 B1**
 (30) 20.12.2005, FR, 0512947
 (96) 15.12.2006, 06841943.1
 (97) 30.09.2009, EP 1963355
 (54) Kolest-4-een-3-oonoksiimi uued derivaadid, neid sisaldavad farmatseutilised kompositsioonid ja nende valmistamise meetod
 (73) Trophos
 Parc Scientifique Luminy, Luminy Biotech
 Entreprises Case 931, 13288 Marseille Cedex 9, FR
 (72) DROUOT, Cyrille
 392 Clos Jean Aicard, F-83300 Draguignan, FR
 MAUX, Delphine
 31, route de Saint Mathieu Résidence les Cascades,
 Bâtiment Niagara, Apt B11, F-06130 Grasse, FR
 (74) Piret Niidas
 OÜ Lasvet
 Suurtüki 4a, 10133 Tallinn, EE
 Patendikirjelduse tõlke esitamise kuupäev 10.12.2009

- (51) **C07K 5/00 (2006.01)** (10) **E003848**
C07K 1/00 (2006.01)
C07K 14/00 (2006.01)
 (11) **EE-EP 1434791 B1**
 (30) 11.10.2001, US, 328624 P

27.09.2002, US, 414155 P
 10.10.2002, US, 269695
 (96) 11.10.2002, 02804105.1
 (97) 07.10.2009, EP 1434791
 (54) Inimese angiopoietiin-2 spetsiifilised sideained
 (73) Amgen, Inc.
 One Amgen Center Drive,
 Thousand Oaks, CA 91320-1799, US
 (72) OLINER, Jonathan, Daniel
 959 Golden Crest Avenue, Newbury, CA 91320, US
 MIN, Hosung
 3875 Conner Court, Newbury Park, CA 91320, US
 (74) Leevi Markus
 Patendibüroo Käosaar & Co OÜ
 Tähe 94, 50107 Tartu, EE
 Patendikirjelduse tõlke esitamise kuupäev 04.01.2010

(51) **C07K 5/08 (2006.01)** (10) **E003849**
A61P 31/14 (2006.01)
A61K 38/06 (2006.01)

(11) **EE-EP 1924593 B1**
 (30) 20.07.2005, US, 700764 P
 07.10.2005, US, 724566 P
 (96) 14.07.2006, 06787475.0
 (97) 16.09.2009, EP 1924593
 (54) HCV NS3-proteaaasi inhibiitorid
 (73) Merck & Co., Inc.
 126 East Lincoln Avenue, Rahway,
 New Jersey 07065, US
 (72) HOLLOWAY, M. Katharine
 126 East Lincoln Avenue, Rahway,
 New Jersey 07065-0907, US
 LIVERTON, Nigel, J.
 126 East Lincoln Avenue, Rahway, NJ 07065-0907,
 US
 LUDMERER, Steven, W.
 126 East Lincoln Avenue, Rahway,
 New Jersey 07065-0907, US
 MCCAULEY, John, A.
 126 East Lincoln Avenue, Rahway, NJ 07065-0907,
 US
 OLSEN, David, B.
 126 East Lincoln Avenue, Rahway,
 New Jersey 07065-0907, US
 RUDD, Michael, T.
 126 East Lincoln Avenue, Rahway,
 New Jersey 07065-0907, US
 VACCA, Joseph, P.
 126 East Lincoln Avenue, Rahway,
 New Jersey 07065-0907, US
 MCINTYRE, Charles, J.
 126 East Lincoln Avenue, Rahway,
 New Jersey 07065-0907, US
 (74) Harald Tehver
 Patendibüroo Turvaja OÜ
 Liivalaia 22, 10118 Tallinn, EE
 Patendikirjelduse tõlke esitamise kuupäev 24.11.2009

(51) **C07K 7/06 (2006.01)** (10) **E003850**
A61K 51/08 (2006.01)
A61K 47/48 (2006.01)
A61K 49/00 (2006.01)

(11) **EE-EP 1648925 B1**
 (30) 30.07.2003, GB, 0317815
 (96) 21.07.2004, 04743485.7
 (97) 09.09.2009, EP 1648925
 (54) Bitsüklilisel peptiidil põhinevad kuvamisained
 (73) GE HEALTHCARE AS
 Nycoveien 2, 0485 Oslo, NO
 (72) CUTHBERTSON, Alan
 Amersham Health AS, Nycoveien 1-2, N-0401 Oslo,
 NO
 SOLBAKKEN, Magne
 Amersham Health AS, Nycoveien 1-2, N-0401 Oslo,
 NO
 (74) Enn Urgas
 Patendibüroo Turvaja OÜ
 Liivalaia 22, 10118 Tallinn, EE
 Patendikirjelduse tõlke esitamise kuupäev 02.12.2009

(51) **C07K 7/06 (2006.01)** (10) **E003851**
C07K 14/47 (2006.01)

(11) **EE-EP 1761553 B1**
 (30) 25.05.2004, DE, 102004026135
 (96) 24.05.2005, 05752606.3
 (97) 21.10.2009, EP 1761553
 (54) MHC molekuliga seonduvad kasvajaga seotud
 peptiidid
 (73) Immatics Biotechnologies GmbH
 Paul-Ehrlich-Strasse 15, 72076 Tübingen, DE
 (72) WEINSCHENK, Toni
 Plochingen Strasse 146, 73730 Esslingen, DE
 LEMMEL, Claudia
 Hundskapfklänge 42a, 72074 Tübingen, DE
 RAMMENSEE, Hans-Georg
 Sommerhalde 3, 72070 Tübingen-Unterjesingen, DE
 STEVANOVIC, Stefan
 Institut für Zellbiologie
 Auf der Morgenstelle 15, 72076 Tübingen, DE
 (74) Enn Urgas
 Patendibüroo Turvaja OÜ
 Liivalaia 22, 10118 Tallinn, EE
 Patendikirjelduse tõlke esitamise kuupäev 29.12.2009

(51) **C07K 14/50 (2006.01)** (10) **E003852**
A61P 3/04 (2006.01)
C12N 15/62 (2006.01)
A61P 3/10 (2006.01)
A61K 38/18 (2006.01)

(11) **EE-EP 1751184 B1**
 (30) 13.05.2004, US, 570908 P
 (96) 02.05.2005, 05742237.0
 (97) 30.09.2009, EP 1751184
 (54) FGF-21 sulandvalgud
 (73) ELI LILLY AND COMPANY
 Lilly Corporate Center, Indianapolis, Indiana 46285,
 US

- (72) GLAESNER, Wolfgang
7512 Fieldstone Court, Indianapolis, Indiana 46254,
US
MILLICAN, Rohn, Lee, Junior
8145 Grassy Meadow Court, Indianapolis, IN 46259,
US
TIAN, Yu
13695 Flintridge Pass, Carmel, IN 46033, US
TSCHANG, Sheng-Hung
Rainbow, 4963 Riley Mews, Carmel, IN 46033, US
- (74) Leevi Markus
Patendibüroo Käosaar & Co OÜ
Tähe 94, 50107 Tartu, EE
- Patendikirjelduse tõlke esitamise kuupäev 01.12.2009

- (51) **C07K 14/50 (2006.01)** (10) **E003853**
C12P 21/00 (2006.01)
A61K 38/18 (2006.01)
- (11) **EE-EP 1789442 B1**
(30) 02.09.2004, US, 606805 P
(96) 26.07.2005, 05775749.4
(97) 30.09.2009, EP 1789442
(54) Fibroblasti kasvufaktori 21 muteiinid
- (73) ELI LILLY AND COMPANY
Lilly Corporate Center, Indianapolis, Indiana 46285,
US
- (72) FRYE, Christopher, Carl
261 Utterback Court, Bargersville, Indiana 46106,
US
HUANG, Lihua
3563 Corsham Circle, Carmel, Indiana 46032, US
MICANOVIC, Radmila
10976 Echo Springs Circle, Indianapolis,
Indiana 46236, US
- (74) Leevi Markus
Patendibüroo Käosaar & Co OÜ
Tähe 94, 50107 Tartu, EE
- Patendikirjelduse tõlke esitamise kuupäev 03.12.2009

- (51) **C07K 14/54 (2006.01)** (10) **E003854**
A61K 39/395 (2006.01)
C07K 14/715 (2006.01)
C07K 16/24 (2006.01)
C12N 15/11 (2006.01)
- (11) **EE-EP 1601694 B1**
(30) 10.03.2003, US, 453672 P
(96) 09.03.2004, 04718824.8
(97) 26.08.2009, EP 1601694
(54) IL-23 antagonistide ning nendega seotud toimeainete kasutamine
- (73) Schering Corporation
2000 Galloping Hill Road,
Kenilworth, NJ 07033-0530, US
- (72) OFT, Martin
1630 Channing Avenue, Palo Alto, CA 94303, US
MCCLANAHAN, Terrill, K.
1081 Westchester Drive, Sunnyvale, CA 94087, US
- (74) Leevi Markus
Patendibüroo Käosaar & Co OÜ

Tähe 94, 50107 Tartu, EE
Patendikirjelduse tõlke esitamise kuupäev 20.11.2009

- (51) **C07K 14/75 (2006.01)** (10) **E003855**
A61K 38/36 (2006.01)
- (11) **EE-EP 1987063 B1**
(30) 23.02.2006, AT, 3022006
(96) 23.02.2007, 07701339.9
(97) 23.09.2009, EP 1987063
(54) Peptiidid ja peptiidide derivaadid, nende valmistamine, samuti nende kasutamine terapeutiliselt ja/või ennetavalt aktiivse farmatseutilise koostise valmistamiseks
- (73) Fibrex Medical Research & Development GmbH
Rabensteig 8/3A, 1010 Wien, AT
- (72) PETZELBAUER, Peter
Lechthalgasse 49/17, A-1230 Wien, AT
HENNING, Rainer
Stöckenweidstrasse 11, CH-8738 Uetliburg, CH
REINGRUBER, Sonja
Lechthalgasse 49/17, A-1230 Wien, AT
- (74) Raivo Koitel
Patendi- & Kaubamärgibüroo Koitel OÜ
Tartu mnt 65, 10115 Tallinn, EE
- Patendikirjelduse tõlke esitamise kuupäev 04.12.2009

- (51) **C07K 14/78 (2006.01)** (10) **E003856**
(11) **EE-EP 1646653 B1**
(30) 15.10.2002, PL, 35665002
(96) 14.10.2003, 03770188.5
(97) 22.07.2009, EP 1646653
(54) Meetod bioloogiliselt aktiivse kollageeni saamiseks lõhelaste sugukonda kuuluvate kalade nahkadest
- (73) Przybylski, Jozef
ul. M. Curie Skłodowskiej 3/2, 81-703 Sopot, PL
Siemaszko Przybylska, Krystyna
ul. M. Curie Skłodowskiej 3/2, 81-703 Sopot, PL
- (72) Przybylski, Jozef
ul. M. Curie Skłodowskiej 3/2, 81-703 Sopot, PL
Siemaszko Przybylska, Krystyna
ul. M. Curie Skłodowskiej 3/2, 81-703 Sopot, PL
- (74) Leevi Markus
Patendibüroo Käosaar & Co OÜ
Tähe 94, 50107 Tartu, EE
- Patendikirjelduse tõlke esitamise kuupäev 14.10.2009

- (51) **C07K 16/24 (2006.01)** (10) **E003857**
G01N 33/68 (2006.01)
C07K 16/46 (2006.01)
- (11) **EE-EP 1694705 B1**
(30) 10.11.2003, US, 518999 P
(96) 09.11.2004, 04810674.4
(97) 26.08.2009, EP 1694705
(54) Interleukiin-10 antikehad
- (73) Schering Corporation
2000 Galloping Hill Road,
Kenilworth, NJ 07033-0530, US
- (72) PRESTA, Leonard G.

1900 Gough Street, No. 206,
San Francisco, CA 94109, US
(74) Leevi Markus
Patendibüroo Käosaar & Co OÜ
Tähe 94, 50107 Tartu, EE
Patendikirjelduse tõlke esitamise kuupäev 20.11.2009

(51) **C08J 9/00 (2006.01)** (10) **E003858**
C08J 9/232 (2006.01)
C08J 3/20 (2006.01)
(11) **EE-EP 1783161 B1**
(30) 20.01.2003, TR, 200300056
15.05.2003, DE, 20307608 U
(96) 02.10.2003, 06017299.6
(97) 09.12.2009, EP 1783161
(54) Isoleeriv vahtmaterjal
(73) Deutsche Amphibolin-Werke von Robert Murjahn
Stiftung & Co KG
Rossdörfer Strasse 50, 64372 Ober-Ramstadt, DE
(72) Jager, Jürgen
Jakob-Fechtig-Weg 2, 65396 Walluf, DE
Schmitt, Günter
Heinrichstr. 3, 69514 Laudenbach, DE
Wagner, Frank
Pestalozzistr. 30, 69483 Wald-Michelbach, DE
Treiber, Christian
Schulstr. 5, 55618 Simmertal, DE
(74) Andres Mutt
OÜ Lasvet
Suurtüki 4a, 10133 Tallinn, EE
Patendikirjelduse tõlke esitamise kuupäev 06.01.2010

(51) **C08K 13/02 (2006.01)** (10) **E003859**
(11) **EE-EP 2010601 B1**
(30) 21.04.2006, DE, 102006018528
(96) 19.04.2007, 07724388.9
(97) 11.11.2009, EP 2010601
(54) Isoleeriv vahtmaterjal
(73) Deutsche Amphibolin-Werke von Robert Murjahn
Stiftung & Co KG
Rossdörfer Strasse 50, 64372 Ober-Ramstadt, DE
(72) WAGNER, Frank
Pestalozzistrasse 30, 69483 Wald-Michelbach, DE
JAGER, Jürgen
Jakob-Fechti-Weg 2, 65396 Walluf, DE
(74) Andres Mutt
OÜ Lasvet
Suurtüki 4a, 10133 Tallinn, EE
Patendikirjelduse tõlke esitamise kuupäev 08.12.2009

(51) **C09D 7/14 (2006.01)** (10) **E003860**
C09B 67/00 (2006.01)
C09D 5/02 (2006.01)
(11) **EE-EP 1819783 B1**
(30) 24.11.2004, FI, 20041513
(96) 24.11.2005, 05817824.5
(97) 07.10.2009, EP 1819783
(54) Eriefektiga värvikomplekt

(73) Tikkurila Oy
Kuninkaalantie 1, 01300 Vantaa, FI
(72) FRERA, Laura
Via O. Regnoli, 7, I-IT-40138 Bologna, IT
(74) Leevi Markus
Patendibüroo Käosaar & Co OÜ
Tähe 94, 50107 Tartu, EE
Patendikirjelduse tõlke esitamise kuupäev 11.12.2009

(51) **C09K 11/06 (2006.01)** (10) **E003861**
C07F 15/00 (2006.01)
B42D 15/00 (2006.01)
G03G 21/04 (2006.01)
G07D 7/12 (2006.01)
(11) **EE-EP 1616929 B1**
(30) 13.07.2004, ES, 200401711
(96) 12.07.2005, 05380153.6
(97) 16.09.2009, EP 1616929
(54) Ruteenium(II)-tüüpi luminesentspigmentide kasutamine turvatavates dokumentides ning meetod ja seade nende avastamiseks
(73) FABRICA NACIONAL DE MONEDA Y TIMBRE
- REAL CASA DE LA MONEDA
Jorge Juan, 106, 28009 Madrid, ES
(72) Orellana Moraleta, Guillermo
Jorge Juan, 106, 28009 Madrid, ES
Garcia Fresnadillo, David
Jorge Juan, 106, 28009 Madrid, ES
Grande Vicente, Cristina
Jorge Juan, 106, 28009 Madrid, ES
Diez Lopez, Raul
Jorge Juan, 106, 28009 Madrid, ES
Delgado Alonso, Jesus
Jorge Juan, 106, 28009 Madrid, ES
Garcia Alonso, Jose Luis
Jorge Juan, 106, 28009 Madrid, ES
Gamo Aranda, Francisco Javier
Jorge Juan, 106, 28009 Madrid, ES
Sanchez Gonzalez, Marcelino
Jorge Juan, 106, 28009 Madrid, ES
(74) Riho Pikkor
Patendibüroo Turvaja OÜ
Liivalaia 22, 10118 Tallinn, EE
Patendikirjelduse tõlke esitamise kuupäev 12.11.2009

(51) **C12N 9/02 (2006.01)** (10) **E003862**
A61K 38/44 (2006.01)
A61P 35/00 (2006.01)
(11) **EE-EP 1481056 B1**
(30) 28.02.2002, IT, MI20020404
(96) 27.02.2003, 03706586.9
(97) 02.09.2009, EP 1481056
(54) Inimese modifitseeritud mangaani sisaldav superoksiidi dismutaas ja selle kasutamine
(73) Mancini, Aldo
Via F. Verrotti, 4, 80128 Napoli, IT
(72) MANCINI, Aldo
Via F. Verrotti, 4, I-80128 Napoli, IT
(74) Leevi Markus

Patendibüroo Käosaar & Co OÜ

Tähe 94, 50107 Tartu, EE

Patendikirjelduse tõlke esitamise kuupäev 26.11.2009

(51) **C12N 15/31 (2006.01)** (10) **E003863**
C07K 14/315 (2006.01)
C07K 16/12 (2006.01)
C12Q 1/68 (2006.01)
A61K 39/09 (2006.01)
G01N 33/68 (2006.01)

(11) **EE-EP 1601770 B1**

(30) 04.03.2003, EP, 03450061

(96) 02.03.2004, 04716233.4

(97) 02.09.2009, EP 1601770

(54) *Streptococcus pyogenes* antigeenid

(73) Intercell AG

Campus Vienna Biocenter 6, 1030 Vienna, AT

(72) MEINKE, Andreas

Piettegasse 26/1, A-3013 Pressbaum, AT

NAGY, Eszter

Taborstrasse 9, A-1020 Vienna, AT

WINKLER, Birgit

Grohgasse 6/6, A-1050 Vienna, AT

GELBMANN, Dieter

Ungergasse 5, A-7163 Andau, AT

(74) Enn Urgas

Patendibüroo Turvaja OÜ

Liivalaia 22, 10118 Tallinn, EE

Patendikirjelduse tõlke esitamise kuupäev 23.11.2009

(51) **C12N 15/49 (2006.01)** (10) **E003864**
A61K 39/295 (2006.01)
C07K 14/16 (2006.01)
C12N 15/62 (2006.01)
A61K 39/21 (2006.01)

(11) **EE-EP 1773999 B1**

(30) 05.08.2004, GB, 0417494

(96) 03.08.2005, 05769948.0

(97) 23.09.2009, EP 1773999

(54) Vaktsiin HIV-nakkuse ennetamiseks ja raviks

(73) GlaxoSmithKline Biologicals S.A.

rue de l'Institut, 89, 1330 Rixensart, BE

(72) ABRECHT, Helge

GlaxoSmithKline Biologicals sa,

rue de l'Institut 89, 1330 Rixensart, BE

DELCHAMBRE, Martine

rue de l'Institut 89, 1330 Rixensart, BE

MARCHAND, Martine,

GlaxoSmithKline Biologicals sa

rue de l'Institut 89, 1330 Rixensart, BE

MATHY, Nathalie Louise

Rue de L'institut, 1330 Rixensart, BE

PERMANNE, Philippe Jean Gervais Ghislain

Rue de L'institut 89, 1330 Rixensart, BE

VOSS, Gerald Hermann

Rue de l'Institut 89, 1330 Rixensart, BE

(74) Leevi Markus

Patendibüroo Käosaar & Co OÜ

Tähe 94, 50107 Tartu, EE

Patendikirjelduse tõlke esitamise kuupäev

08.12.2009

(51) **C12N 15/54 (2006.01)** (10) **E003865**
C12N 15/82 (2006.01)
C12N 9/10 (2006.01)
A01H 5/00 (2006.01)
C12N 5/10 (2006.01)
C12Q 1/48 (2006.01)

(11) **EE-EP 1963510 B1**

(30) 01.12.2005, US, 741166 P

30.06.2006, US, 817799 P

(96) 01.12.2006, 06844685.5

(97) 26.08.2009, EP 1963510

(54) GRG23 ja GRG51 geenid, mis annavad herbitsiidiresistentsuse

(73) Athenix Corporation

108 T W Alexander Drive PO Box 110347,
Research Triangle Park, NC 27709, US

(72) PETERS, Cheryl, L.

6308 VALLEY ESTATES DRIVE,

Raleigh, NC 27612, US

HINSON, Jill

3510 Moriah Road, Rougemont,

North Carolina 27572, US

HAMMER, Philip, E.

215 COVINGTON SQUARE DRIVE,

Cary, NC 27513, US

VANDE BERG, Brian

5012 SILHOUETTE DRIVE, Durham, NC 27713,
US

SCHOUTEN, Laura, Cooper

71 Holly Ridge Road, Pittsboro, NC 27312, US

CARR, Brian

3104 SHINLEAF COURT, Raleigh, NC 27613, US

(74) Enn Urgas

Patendibüroo Turvaja OÜ

Liivalaia 22, 10118 Tallinn, EE

Patendikirjelduse tõlke esitamise kuupäev 25.11.2009

(51) **C12N 15/82 (2006.01)** (10) **E003866**
C07K 14/325 (2006.01)
A01H 5/00 (2006.01)

(11) **EE-EP 1504104 B1**

(30) 03.05.2002, US, 137682

(96) 29.04.2003, 03722597.6

(97) 12.08.2009, EP 1504104

(54) Putukakindlad taimed ja nende saamise meetodid

(73) Bayer BioScience N.V.

Technologiepark 38, 9052 Gent, BE

(72) JANSSENS, Stefan

Coupure Links 705, B-9000 Gent, BE

VAN HOUDET, Sara

Poortweg 7, B-9620 Zottegem, BE

REYNAERTS, Arlette

Buisstraat 5, B-9031 Drogenen, BE

(74) Enn Urgas

Patendibüroo Turvaja OÜ

Liivalaia 22, 10118 Tallinn, EE

Patendikirjelduse tõlke esitamise kuupäev 12.11.2009

-
- (51) **C12Q 1/68 (2006.01)** (10) **E003867**
 (11) **EE-EP 1576187 B1**
 (30) 23.12.2002, IT, MI200022743
 (96) 22.12.2003, 03785912.1
 (97) 09.09.2009, EP 1576187
 (54) Meetod tsirkuleeriva DNA koguse määramiseks plasmas ja vähi avastamine
 (73) ISTITUTO NAZIONALE PER LO STUDIO E LA CURA DEI TUMORI
 Via Venezian, 1, I-20133 Milano, IT
 (72) SOZZI, Gabriella
 Via Venezian, 1, I-20133 Milano, IT
 (74) Enn Urgas
 Patendibüroo Turvaja OÜ
 Liivalaia 22, 10118 Tallinn, EE
 Patendikirjelduse tõlke esitamise kuupäev 08.12.2009
-

- (51) **D01D 5/00 (2006.01)** (10) **E003868**
 (11) **EE-EP 1673493 B1**
 (30) 08.09.2003, CZ, 20032421
 (96) 08.09.2004, 04762308.7
 (97) 08.07.2009, EP 1673493
 (54) Meetod ja seade nanofiibri tootmiseks polümeeri-segust, kasutades elektrostaatilist pöörlemist elektriväljas
 (73) Technicka Univerzita v Liberci
 Studentska 2, 461 17 Liberec, CZ
 (72) JIRSAK, Oldrich
 Sramkova 151, 460 10 Liberec 20, CZ
 SANETRNIK, Filip
 Neklanova 814, 460 14 Liberec 14, CZ
 LUKAS, David
 Na Zizkove 853, 460 06 Liberec 6, CZ
 KOTEK, Vaclav
 Karla Capka 331/9, 460 05 Liberec 5, CZ
 MARTINOVA, Lenka
 Sosnova 18, 460 01 Liberec 15, CZ
 CHALOUPEK, Jiri
 Pincova 33, 400 11 Usti nad Labem, CZ
 (74) Jüri Käosaar
 Patendibüroo Käosaar & Co OÜ
 Tähe 94, 50107 Tartu, EE
 Patendikirjelduse tõlke esitamise kuupäev 06.10.2009
-

- (51) **E01B 7/02 (2006.01)** (10) **E003869**
 (11) **EE-EP 1516091 B1**
 (30) 27.06.2002, AT, 9672002
 (96) 16.06.2003, 03729697.7
 (97) 25.11.2009, EP 1516091
 (54) Tugevdatud sulgrööpaga pöörang
 (73) VAE EISENBAHNSYSTEME GMBH
 Alpinestrasse 1, 8740 Zeltweg, AT
 VAE GmbH
 Rotenturmstrasse 5-9, 1010 Wien, AT
 (72) FRITZ, Dieter
 Obere Kolonie 9a, A-8753 Fohnsdorf, AT

- ORASCHE, Hermann
 Hauptstrasse 66A, A-8740 Zeltweg, AT
 (74) Riho Pikkor
 Patendibüroo Turvaja OÜ
 Liivalaia 22, 10118 Tallinn, EE
 Patendikirjelduse tõlke esitamise kuupäev 15.12.2009
-

- (51) **E01B 29/28 (2006.01)** (10) **E003870**
 (11) **EE-EP 1931828 B1**
 (30) 25.08.2005, AT, 14002005
 (96) 23.08.2006, 06777034.7
 (97) 15.07.2009, EP 1931828
 (54) Meetod ja sõidukikombinatsioon raudteerööpmestiku töötlemiseks
 (73) ÖBB-Infrastruktur Aktiengesellschaft
 Vivenotgasse 10, 1120 Wien, AT
 (72) KETTL, Alois
 Steinbruck 6, A-4742 Pram, AT
 (74) Juhan Hämmalov
 OÜ Intels
 Riia 11-3, 51010 Tartu, EE
 Patendikirjelduse tõlke esitamise kuupäev 14.10.2009
-

- (51) **E04B 1/21 (2006.01)** (10) **E003871**
E04B 1/61 (2006.01)
 (11) **EE-EP 1532323 B1**
 (30) 22.05.2002, NO, 20022422
 (96) 15.04.2003, 03728170.6
 (97) 05.08.2009, EP 1532323
 (54) Tariementide kinnitamine
 (73) SB Produksjon AS
 P.O. Box 73, 6301 Andalsnes, NO
 (72) BERG, Svein
 Einagata 18, N-6320 ISFJORDEN, NO
 JAHREN, Per
 Vakasveien 79, N-1395 HVALSTAD, NO
 (74) Tõnu Nelsas
 AAA Patendibüroo OÜ
 Tartu mnt 16, 10117 Tallinn, EE
 Patendikirjelduse tõlke esitamise kuupäev 22.10.2009
-

- (51) **E04C 2/04 (2006.01)** (10) **E003872**
E04F 13/08 (2006.01)
 (11) **EE-EP 1355015 B1**
 (30) 15.04.2002, BE, 200200262
 (96) 15.04.2003, 03076101.9
 (97) 04.11.2009, EP 1355015
 (54) Meetod ennastkandva seinalelemendi eelvalmistamiseks
 (73) Wienerberger Bricks N.V.
 Ter Bede Business Center, Kapel ter Bede 86,
 8500 Kortrijk, BE
 (72) Van Reeth, Rudy
 Pullaarsteenweg 149, 2870 Puurs, BE
 (74) Alla Hämmalov
 OÜ Intels
 Riia 11-3, 51010 Tartu, EE

Patendikirjelduse tõlke esitamise kuupäev 17.12.2009

-
- (51) **E04C 2/12 (2006.01)** (10) **E003873**
E04C 3/12 (2006.01)
 (11) **EE-EP 1532326 B1**
 (30) 19.06.2002, SE, 0201868
 (96) 12.06.2003, 03733730.0
 (97) 14.10.2009, EP 1532326
 (54) Paneel, millel on puidust keha, mis on moodustatud lauakujulistest tariementidest
 (73) Swedwood International AB
 Långskeppsgatan 8, 262 71 Ängelholm, SE
 (72) STRIDSMAN, Per-Eric
 Fridhäll, S-289 50 Hanaskog, SE
 (74) Tõnu Nelsas
 AAA Patendibüroo OÜ
 Tartu mnt 16, 10117 Tallinn, EE

Patendikirjelduse tõlke esitamise kuupäev 22.12.2009

-
- (51) **E04H 12/02 (2006.01)** (10) **E003874**
E01F 9/018 (2006.01)
 (11) **EE-EP 1415058 B1**
 (30) 06.07.2001, FI, 20011489
 (96) 03.07.2002, 02755034.2
 (97) 16.09.2009, EP 1415058
 (54) Post
 (73) Jerol Industri AB
 P.O. Box 62, 815 22 Tierp, SE
 (72) JERNSTRÖM, Rolf
 Skutvägen 1, FIN-10600 Ekenäs, FI
 (74) Ljubov Kesselman
 OÜ Kesna
 Tedre 77-52, 10616 Tallinn, EE

Patendikirjelduse tõlke esitamise kuupäev 20.11.2009

-
- (51) **E04H 12/12 (2006.01)** (10) **E003875**
E04H 12/16 (2006.01)
F03D 11/04 (2006.01)
 (11) **EE-EP 1876316 B1**
 (30) 21.04.2005, ES, 200500965
 (96) 20.04.2006, 06743451.4
 (97) 17.06.2009, EP 1876316
 (54) Monteeritav moodultorn
 (73) Structural Concrete & Steel S.L.
 El Temple 1, 50003 Zaragoza, ES
 (72) MONTANER FRAGÜET, Jesús
 C/ Temple 1, E-50003 Zaragoza, ES
 MARI BERNAT, Antonio Ricardo
 C/ Temple 1, E-50003 Zaragoza, ES
 (74) Jüri Käosaar
 Patendibüroo Käosaar & Co OÜ
 Tähe 94, 50107 Tartu, EE

Patendikirjelduse tõlke esitamise kuupäev 09.09.2009

-
- (51) **E05B 47/00 (2006.01)** (10) **E003876**
E05B 47/02 (2006.01)
E05B 47/06 (2006.01)

(11) **EE-EP 2016243 B1**

(30) 02.05.2006, FI, 20065281

(96) 23.04.2007, 07730702.3

(97) 14.10.2009, EP 2016243

(54) Lukukorpus

(73) Abloy Oy

Wahlforssinkatu 20, 80100 Joensuu, FI

(72) RAATIKAINEN, Juha

Miilunpolttajantie 7, FIN-80160 Joensuu, FI

(74) Tõnu Nelsas

AAA Patendibüroo OÜ

Tartu mnt 16, 10117 Tallinn, EE

Patendikirjelduse tõlke esitamise kuupäev 30.12.2009

(51) **E05F 15/10 (2006.01)** (10) **E003877**
E05F 15/14 (2006.01)

(11) **EE-EP 1365095 B1**

(30) 23.05.2002, IT, MI20021112

(96) 20.05.2003, 03011411.0

(97) 07.10.2009, EP 1365095

(54) Motoriseeritud liugukse juhtimis- ja seiskamiseseade

(73) FAAC S.p.A.

Via Benini, 1, I-40069 Zola Predosa (Bologna), IT

(72) Manini, Michelangelo

Via Porrettana 16/5, 40135 Bologna, IT

(74) Jüri Käosaar

Patendibüroo Käosaar & Co OÜ

Tähe 94, 50107 Tartu, EE

Patendikirjelduse tõlke esitamise kuupäev 05.01.2010

(51) **F03B 13/10 (2006.01)** (10) **E003878**
F03B 13/08 (2006.01)

(11) **EE-EP 1440240 B1**

(30) 19.10.2001, DE, 10152712

(96) 27.09.2002, 02801875.2

(97) 02.12.2009, EP 1440240

(54) Hürdoelektrijaama generaator

(73) Wobben, Aloys

Argestrasse 19, 26607 Aurich, DE

(72) Wobben, Aloys

Argestrasse 19, 26607 Aurich, DE

(74) Tarmo Rosman

Rosman ja Partnerid OÜ

pk 652, 12602 Tallinn, EE

Patendikirjelduse tõlke esitamise kuupäev 11.12.2009

(51) **F03D 1/06 (2006.01)** (10) **E003879**

(11) **EE-EP 2018475 B1**

(30) 11.05.2006, DE, 102006022279

(96) 10.05.2007, 07728985.8

(97) 16.12.2009, EP 2018475

(54) Tuuleenergiaseadme rootorilaba

(73) Wobben, Aloys

Argestrasse 19, 26607 Aurich, DE

(72) ROHDEN, Rolf

Wallster Loog 10, 26607 Aurich, DE

(74) Tarmo Rosman

Rosman ja Partnerid OÜ

pk 652, 12602 Tallinn, EE
Patendikirjelduse tõlke esitamise kuupäev 23.12.2009

- (51) **F16B 25/00 (2006.01)** (10) **E003880**
F16B 35/04 (2006.01)
(11) **EE-EP 1971786 B1**
(30) 12.01.2006, DE, 202006000479 U
(96) 20.10.2006, 06807429.3
(97) 09.12.2009, EP 1971786
(54) Isesüvistuv ja keermestav kruvi
(73) SPAX International GmbH & Co. KG
Kölner Strasse 71-77, 58256 Ennepetal, DE
(72) LANGEWIESCHE, Frank
Schwelmer Str. 18, 45549 Sprockhövel, DE
(74) Alla Hämmalov
OÜ Intels
Riia 11-3, 51010 Tartu, EE
Patendikirjelduse tõlke esitamise kuupäev 10.12.2009

- (51) **F16L 21/04 (2006.01)** (10) **E003881**
(11) **EE-EP 2000728 B1**
(96) 29.03.2006, 06725845.9
(97) 11.11.2009, EP 2000728
(54) Üldotstarbeline vedelikukindl tihend
(73) Belgicast Internacional, S.L.U.
B DEG Zabalondo 31, 48100 Munguia, ES
(72) AZPIAZU NÚÑEZ, Jose Antonio
Bº Zabalondo, 31, E-48100 Munguia, ES
(74) Riho Pikkor
Patendibüroo Turvaja OÜ
Liivalaia 22, 10118 Tallinn, EE
Patendikirjelduse tõlke esitamise kuupäev 08.12.2009

- (51) **F16L 37/092 (2006.01)** (10) **E003882**
(11) **EE-EP 1800047 B1**
(30) 14.10.2004, NL, 1027253
(96) 10.10.2005, 05792226.2
(97) 23.12.2009, EP 1800047
(54) Toruühendusmuhv
(73) Wavin B.V.
Stationsplein 3, 8011 CW Zwolle, NL
(72) ROELFSEMA, Marcel
39 Scheepswerfkade, NL-9503 PB Stadskanaal, NL
NAAKTGEBOREN, Aart, Jacob
132, De Aak, NL-7701 LD Dedemsvaart, NL
VAN DIJK, Berend, Jan
13 Prinses Marijkelaan, NL-7776 XA Slagharen, NL
SNIJDERS, Johannes, Hendrikus, Gerhardus
42, Beethovenstraat, NL-7651 RC Tubbergen, NL
SPYKMAN, Johannes
7, Oeveringer Feldweg, 49824 Emlichheim, DE
DE GREEF, Peter, Evert, Jacobus
41 Van Haeringenstraat, NL-7701 CN Dedemsvaart, NL
(74) Jürgen Toome
OÜ Lasvet
Suurtüki 4a, 10133 Tallinn, EE

Patendikirjelduse tõlke esitamise kuupäev 28.12.2009

- (51) **F16M 7/00 (2006.01)** (10) **E003883**
(11) **EE-EP 1581766 B1**
(30) 06.01.2003, NL, 1022310
06.01.2003, NL, 1022308
(96) 06.01.2004, 04700302.5
(97) 21.10.2009, EP 1581766
(54) Reguleeritav jalg seadmete rihtimiseks
(73) Machine Support B.V.
Kaartenmakerstraat 7, 2984 CB Ridderkerk, NL
(72) VERMEULEN, Rene
Anke Servaesstraat 1, NL-3207 HM Spijkenisse, NL
(74) Tõnu Nelsas
AAA Patendibüroo OÜ
Tartu mnt 16, 10117 Tallinn, EE
Patendikirjelduse tõlke esitamise kuupäev 30.12.2009

- (51) **F21S 9/03 (2006.01)** (10) **E003884**
F21W 101/02 (2006.01)
(11) **EE-EP 1818604 B1**
(30) 08.02.2006, IT, MI20060213
(96) 05.02.2007, 07101705.7
(97) 22.07.2009, EP 1818604
(54) Valgustusvõrk
(73) iGUZZINI ILLUMINAZIONE S.p.A.
Via Mariano Guzzini 37, 62019 Recanati-Macerata, IT
(72) Guzzini, Giannunzio
Piazza G. Leopardi 7, 62019 Recanati (Macerata), IT
(74) Jüri Käosaar
Patendibüroo Käosaar & Co OÜ
Tähe 94, 50107 Tartu, EE
Patendikirjelduse tõlke esitamise kuupäev 21.10.2009

- (51) **F23J 15/02 (2006.01)** (10) **E003885**
B01D 45/06 (2006.01)
B01D 45/02 (2006.01)
(11) **EE-EP 1747400 B1**
(30) 21.05.2004, SE, 0401304
(96) 20.05.2005, 05741237.1
(97) 07.10.2009, EP 1747400
(54) Meetod ja seade tolmuosakeste eraldamiseks
(73) Alstom Technology Ltd
Brown Boveri Strasse 7, 5400 Baden, CH
(72) ANDERSSON, Rune
Andvägen 9, S-352 42 Växjö, SE
(74) Tõnu Nelsas
AAA Patendibüroo OÜ
Tartu mnt 16, 10117 Tallinn, EE
Patendikirjelduse tõlke esitamise kuupäev 22.12.2009

- (51) **F42B 12/06 (2006.01)** (10) **E003886**
F42B 12/34 (2006.01)
F42B 12/74 (2006.01)
(11) **EE-EP 1745260 B1**
(30) 11.05.2004, US, 569876 P

- (96) 09.05.2005, 05735953.1
 (97) 16.09.2009, EP 1745260
 (54) Pliivaba kuul
 (73) RUAG Ammotec AG
 Uttigenstrasse 67, 3602 Thun, CH
 (72) SPATZ, Peter
 Talackerstrasse 45B, CH-3604 Thun, CH
 BAUMGARTNER, Hans
 Frutigenstrasse 16, CH-3600 Thun, CH
 SCHAER, Fritz
 Sonnenrain 6C, CH-3700 Spiezwiler, CH
 (74) Andres Mutt
 OÜ Lasvet
 Suurtüki 4a, 10133 Tallinn, EE
 Patendikirjelduse tõlke esitamise kuupäev 13.11.2009

- (51) **G01F 1/66 (2006.01)** (10) **E003887**
A61M 1/36 (2006.01)
 (11) **EE-EP 1840534 B1**
 (30) 29.03.2006, US, 391748
 (96) 13.03.2007, 07104078.6
 (97) 30.09.2009, EP 1840534
 (54) Kirurgiline süsteem akustiliselt sidestatud kassetiga
 (73) Alcon, Inc.
 P.O. Box 62, Bösch 69, 6331 Hünenberg, CH
 (72) Hopkins, Mark A.
 26691 San Gonzalo, Mission Viejo, CA 93691, US
 Nazarifar, Nader
 28421 La Pradera, Laguna Niguel, CA 92677, US
 Chun, Jeffrey J.
 11 Milagra, Irvine, CA 92602, US
 Williams, David L.
 407 Pirate Road, Newport Beach, CA 92663, US
 (74) Arno Anijalg
 Patendibüroo Ustervall OÜ
 Kivi 21-6, 51009 Tartu, EE
 Patendikirjelduse tõlke esitamise kuupäev 07.12.2009

- (51) **G01N 33/574 (2006.01)** (10) **E003888**
 (11) **EE-EP 1861713 B1**
 (30) 21.03.2005, US, 663818 P
 22.09.2005, US, 719726 P
 14.03.2006, US, 782261 P
 (96) 20.03.2006, 06727336.7
 (97) 23.09.2009, EP 1861713
 (54) PET märkainete sõelumismeetod varajase vähiravi jälgimiseks
 (73) GE Healthcare Limited
 Amersham Place Little Chalfont, Buckinghamshire HP7 9NA, GB
 (72) BERGSTROM, Mats
 Uppsala Imanet AB, P.O. Box 967,
 S-751 09 Uppsala, SE
 RAZIFAR, Pasha
 Uppsala University, Box 967, S-751 24 Uppsala, SE
 MONNAZZAM, Azita
 Uppsala University, P.O. Box 967,
 S-751 24 Uppsala, SE
 LINDHE, Orjan

- Uppsala Imanet AB, P.O. Box 967,
 S-751 09 Uppsala, SE
 AWAD, Raymond
 Uppsala Imanet AB, P.O. Box 967,
 S-751 09 Uppsala, SE
 LANGSTROM, Bengt
 Uppsala Imanet AB, P.O. Box 967,
 S-751 09 Uppsala, SE
 JOSEPHSSON, Raymond
 Biovica AB, Uppsala Science Park 32a,
 S-751 83 Uppsala, SE
 BLOMQVIST, Carl
 Uppsala University, P.O. Box 967,
 S-751 24 Uppsala, SE

- (74) Harald Tehver
 Patendibüroo Turvaja OÜ
 Liivalaia 22, 10118 Tallinn, EE
 Patendikirjelduse tõlke esitamise kuupäev 07.12.2009

- (51) **G01N 33/68 (2006.01)** (10) **E003889**
 (11) **EE-EP 1991875 B1**
 (30) 06.03.2006, DE, 102006010647
 (96) 03.03.2007, 07723032.4
 (97) 23.09.2009, EP 1991875
 (54) Test patoloogiliste prionide tuvastamiseks
 (73) Latza, Reinhard, Dr.
 Blücher Strasse 47a, 66386 St. Ingbert, DE
 (72) Latza, Reinhard, Dr.
 Blücher Strasse 47a, 66386 St. Ingbert, DE
 (74) Enn Urgas
 Patendibüroo Turvaja OÜ
 Liivalaia 22, 10118 Tallinn, EE
 Patendikirjelduse tõlke esitamise kuupäev 07.12.2009

- (51) **G01S 7/14 (2006.01)** (10) **E003890**
G01S 7/24 (2006.01)
G01S 13/86 (2006.01)
G01S 13/93 (2006.01)
G01S 13/72 (2006.01)
 (11) **EE-EP 2047291 B1**
 (30) 03.08.2006, GB, 0615426
 (96) 14.06.2007, 07733757.4
 (97) 16.09.2009, EP 2047291
 (54) Radari kuvar- ja tööflusseade
 (73) Samarai, Faris
 Aberdeen Airport 6, Ninians Road,
 Aberdeen AB2 0PD, GB
 (72) Samarai, Faris
 Aberdeen Airport 6, Ninians Road,
 Aberdeen AB2 0PD, GB
 (74) Juhan Hämmalov
 OÜ Intels
 Riia 11-3, 51010 Tartu, EE
 Patendikirjelduse tõlke esitamise kuupäev 08.12.2009

- (51) **G02B 5/30 (2006.01)** (10) **E003891**
B42D 15/10 (2006.01)
G03H 1/18 (2006.01)

(11) **EE-EP 1724619 B1**
 (30) 17.04.2003, DE, 10318157
 (96) 08.04.2004, 06015946.4
 (97) 14.10.2009, EP 1724619
 (54) Kile ja optiline turvaelement
 (73) Leonhard Kurz Stiftung & Co. KG
 Schwabacher Strasse 482, 90763 Fürth, DE
 (72) Katschorek, Haymo
 Am Heckacker 15a, 90587 Obermichelbach, DE
 Seitz, Mathias
 Am Ruhstein 26, 91054 Buckenhof, DE
 (74) Andres Mutt
 OÜ Lasvet
 Suurtüki 4a, 10133 Tallinn, EE
 Patendikirjelduse tõlke esitamise kuupäev 05.01.2010

(51) **G02B 5/30 (2006.01)** (10) **E003892**
B42D 15/10 (2006.01)
G03H 1/18 (2006.01)
 (11) **EE-EP 1722255 B1**
 (30) 17.04.2003, DE, 10318157
 (96) 08.04.2004, 06015947.2
 (97) 28.10.2009, EP 1722255
 (54) Kile ja optiline turvaelement
 (73) Leonhard Kurz Stiftung & Co. KG
 Schwabacher Strasse 482, 90763 Fürth, DE
 (72) Katschorek, Haymo
 Am Heckacker 15a, 90587 Obermichelbach, DE
 Seitz, Mathias
 Am Ruhstein 26, 91054 Buckenhof, DE
 (74) Andres Mutt
 OÜ Lasvet
 Suurtüki 4a, 10133 Tallinn, EE
 Patendikirjelduse tõlke esitamise kuupäev 07.01.2010

(51) **G05B 9/02 (2006.01)** (10) **E003893**
G05B 17/02 (2006.01)
 (11) **EE-EP 1788461 B1**
 (30) 22.11.2005, US, 738921 P
 (96) 21.04.2006, 06008296.3
 (97) 17.06.2009, EP 1788461
 (54) Seade ja meetod andurite paigutuse konstrueerimiseks turvalisele automatiseeritud süsteemile, automatiseeritud süsteem, programmelement ja arvuti poolt loetav kandja
 (73) Multitel ASBL
 Avenue Nicolas Copernic 1, 7000 Mons, BE
 Faculté Polytechnique de Mons
 Rue de Houdain, 9, 7000 Mons, BE
 (72) Meers, Francois
 30, rue de la Raquette, 7000 Mons, BE
 Bilenne, Olivier
 24, route d'Esneux, 4121 Neuville-En-Condroz, BE
 Massar, Marc
 24, rue Théophile Vander Elst, Watermael-Boitsfort, 1170 Brussels, BE
 Druet, Emmanuel
 178, rue Henri Blès, 5000 Namur, BE
 (74) Mart Enn Koppel

Patendibüroo Koppel OÜ
 Kajaka 4-10, 11317 Tallinn, EE
 Patendikirjelduse tõlke esitamise kuupäev 12.11.2009

(51) **G07F 11/42 (2006.01)** (10) **E003894**
 (11) **EE-EP 1730708 B1**
 (30) 01.03.2004, FR, 0402074
 01.07.2004, FR, 0407298
 (96) 24.02.2005, 05708584.7
 (97) 29.07.2009, EP 1730708
 (54) Mahukate ja/või raskete toodete ja/või pakkides müüdavate toodete automaatne väljajagamise seade
 (73) STAAKE Investment & Consulting GmbH & Co. KG
 Wilhelmitorwall 28, 38118 Braunschweig, DE
 (72) Leonetti, Philippe
 16 Chemin de Padaine, 88700 Rambervillers, FR
 (74) Jüri Käosaar
 Patendibüroo Käosaar & Co OÜ
 Tähe 94, 50107 Tartu, EE
 Patendikirjelduse tõlke esitamise kuupäev 28.10.2009

(51) **H01F 1/01 (2006.01)** (10) **E003895**
 (11) **EE-EP 1415311 B1**
 (30) 31.07.2001, NL, 1018668
 (96) 12.07.2002, 02746212.6
 (97) 01.07.2009, EP 1415311
 (54) Magnetiliseks külmutamiseks kasutatav materjal ja meetod selle valmistamiseks
 (73) Stichting voor de Technische Wetenschappen
 P.O. Box 3021, 3502 Utrecht, NL
 Universiteit van Amsterdam, Faculteit der Natuurwetenschappen, Wiskunde en Informatica
 Spui 21, 1012-WX Amsterdam, NL
 (72) BRÜCK, Ekkehard, Hubertus
 Hof van Versailles 55, NL-1064 NX Amsterdam, NL
 TEGUSI, Ojjiyed
 Florijn 425, NL-1102 BA Amsterdam, NL
 DE BOER, Frank, Roelof
 Gerdinkhof 31, NL-1103 PP Amsterdam, NL
 (74) Jüri Käosaar
 Patendibüroo Käosaar & Co OÜ
 Tähe 94, 50107 Tartu, EE
 Patendikirjelduse tõlke esitamise kuupäev 30.09.2009

(51) **H01G 9/058 (2006.01)** (10) **E003896**
H01M 4/02 (2006.01)
 (11) **EE-EP 1678728 B1**
 (30) 14.10.2003, US, 510838 P
 (96) 14.10.2004, 04770253.5
 (97) 19.08.2009, EP 1678728
 (54) Elektrood energiasalvestuse seadmete jaoks ja sellel elektroodil põhinev elektrokeemiline superkondensaator
 (73) Gen3 Partners, Inc.
 Ten Post Office Square, 9th Floor,
 Boston, MA 02109, US
 (72) TIMONOV, Alexander

Liteyniy Prospect 16 Apt. 12,
St. Petersburg, 191028, RU
LOGVINOV, Sergey
Dobrolubova Ave. 7/2 Apt. 85,
St. Petersburg, 197198, RU
PIVUNOV, Dmitry
Dolgoozernaya Str., 18 Apt. 93,
St. Petersburg, 197349, RU
(74) Tõnu Nelsas
AAA Patendibüroo OÜ
Tartu mnt 16, 10117 Tallinn, EE
Patendikirjelduse tõlke esitamise kuupäev 13.11.2009

(51) **H01J 61/24 (2006.01)** (10) **E003897**
H01J 9/395 (2006.01)
H01J 7/20 (2006.01)
B22F 1/00 (2006.01)
C22C 7/00 (2006.01)
C22C 30/02 (2006.01)
(11) **EE-EP 1953800 B1**
(30) 23.07.2004, IT, MI20041494
(96) 07.07.2005, 08156679.6
(97) 30.09.2009, EP 1953800
(54) Elavhõbedat vabastavad kompositsioonid
(73) SAES GETTERS S.p.A.
Via Italia, 77, I-20020 Lainate, IT
(72) Coda, Alberto
Via per Uboldo 47, 21040, Gerenzano VA, IT
Corazza, Alessio
Via Avignone 63, 22030, Como - Camnago Volta
CO, IT
Gallitognotta, Alessandro
Via Marconi 52, 21040, Origgio VA, IT
Massaro, Vincenzo
Località Cascina Faustina 5, 20080, Albairate MI, IT
Porro, Mario
Vicolo Natisone 58, 21042, Caronno Pertusella VA,
IT
Toia, Luca
Via della Fontana 14/a, 21040, Carnago VA, IT
(74) Tõnu Nelsas
AAA Patendibüroo OÜ
Tartu mnt 16, 10117 Tallinn, EE
Patendikirjelduse tõlke esitamise kuupäev 14.12.2009

(51) **H02G 7/00 (2006.01)** (10) **E003898**
(11) **EE-EP 1826882 B1**
(30) 22.02.2006, DE, 202006002948 U
(96) 13.01.2007, 07000641.6
(97) 30.09.2009, EP 1826882
(54) Õhuliinimasti traaversi isoleerkate
(73) Europoles GmbH & Co. KG
Ingolstädter Strasse 51, 92318 Neumarkt, DE
(72) Simson, Georg
Von-Tanne-Strasse 21, 92348 Berg, DE
Gottschalk, Harald
Mantlacher Weg 8, 92358 Batzhausen, DE
(74) Riho Pikkor
Patendibüroo Turvaja OÜ

Liivalaia 22, 10118 Tallinn, EE
Patendikirjelduse tõlke esitamise kuupäev 24.11.2009

(51) **H04B 7/26 (2006.01)** (10) **E003899**
H04W 76/00 (2006.01)
(11) **EE-EP 1730858 B1**
(96) 16.03.2004, 04720890.5
(97) 30.09.2009, EP 1730858
(54) Dupleksandmeedastuse meetod, seade ja süsteem
(73) Nokia Corporation
Keilalahdentie 4, 02150 Espoo, FI
(72) HOTTINEN, Ari
Kielotie 30-32 C 25, FI-01300 Vantaa, FI
(74) Jüri Käosaar
Patendibüroo Käosaar & Co OÜ
Tähe 94, 50107 Tartu, EE
Patendikirjelduse tõlke esitamise kuupäev 29.12.2009

(51) **H04L 12/28 (2006.01)** (10) **E003900**
(11) **EE-EP 1527565 B1**
(30) 09.08.2002, US, 215701
23.09.2002, US, 252849
(96) 08.08.2003, 03785061.7
(97) 07.10.2009, EP 1527565
(54) Mobiilüksuse konfiguratsioonihaldus raadio-
kohtvõrkude (WLAN) jaoks
(73) Wavelink Corporation
6985 Union Park Ave., Suite 335,
Midvale, UT 84047-4155, US
(72) WHELAN, Robert
630 11th Avenue, West, Kirkland, WA 98033, US
VAN WAGENEN, Lamar
981 E. Diana Hills Way, Sandy, UT 84094, US
MORRIS, Roy
8812 NE 191st Place, Bothell, WA 98011, US
(74) Riho Pikkor
Patendibüroo Turvaja OÜ
Liivalaia 22, 10118 Tallinn, EE
Patendikirjelduse tõlke esitamise kuupäev 27.11.2009

(51) **H04R 25/00 (2006.01)** (10) **E003901**
(11) **EE-EP 1933590 B1**
(30) 12.12.2006, DE, 102006058520
(96) 20.11.2007, 07022518.0
(97) 07.10.2009, EP 1933590
(54) Kuulmisaparaatide reguleerimismeetod
(73) GEERS Hörakustik AG & Co. KG
Otto-Hahn-Strasse 35, 44227 Dortmund, DE
(72) Schmalfuss, Georg, Dr.-Ing.
Otto-Baer-Strasse 1, 01445 Radebeul, DE
Haubold, Jörg, Dr.-Ing.
Witthausstrasse 42, 44287 Dortmund, DE
(74) Toom Pungas
OÜ Synest
pk 977, 13402 Tallinn, EE
Patendikirjelduse tõlke esitamise kuupäev 18.12.2009

**HH2A/HH4A. EUROOPA PATENDITAOTLUSTE JA EESTIS KEHTIVATE
EUROOPA PATENTIDE PATENDIKIRJELDUSE TÕLGETE PARANDUSED**

Teade avaldatakse "Euroopa patentide väljaandmise konventsiooni kohaldamise seaduse" § 9 alusel.

Eesti Patendilehe number	Patendikirjelduse tõlke number	Muudatuse lühiseeloomustus
2009, 3	E003054	Eestis kehtivate Euroopa patentide registris on vastavalt Euroopa patentide väljaandmise konventsiooni kohaldamise seaduse §-le 9 parandatud 30.12.2009 patendikirjelduse tõlget EE-EP 1 608 374 B9.

TZ4A. REGISTREERINGU ANDMETE PARANDUSED JA MUUDATUSED

Eesti Patendi- lehe number	Regist- reeringu number	Rahvusvahelise patendiklassi- fikatsiooni indeksid	Avaldatud andmed	Parandatud ja muudetud andmed	Kood (WIPO ST. 17)
2007, 2	E000978	G01N 33/569 G01N 33/92	Tõnu Nelsas AAA Patendibüroo OÜ, Tartu mnt 16, 10117 Tallinn, EE	Raivo Koitel Patendi- & Kaubamärgibüroo Koitel OÜ, Tartu mnt 65, 10115 Tallinn, EE	TC4A TC4A TE4A
2007, 3	E001103	C12N 15/11 C07H 21/00 A61K 31/713 C12Q 1/68 A01K 67/027 C12N 5/10	atugen AG Robert-Rössle-Strasse 10, 13125 Berlin, DE	Silence Therapeutics AG Robert-Rössle-Strasse 10, 13125 Berlin, DE	TC4A
2009, 6	E003671	C07J 53/00 A61K 31/585 A61P 5/34	Schering Aktiengesellschaft Müllerstrasse 178, 13353 Berlin, DE	Bayer Schering Pharma Aktiengesellschaft Müllerstrasse 178, 13353 Berlin, DE	TC4A
2009, 6	E003661	C07D 471/08 C07D 487/08 A61K 31/4995 A61P 25/28	Sanofi-Aventis 174, Avenue de France, 75013 Paris, FR Mitsubishi Tanabe Pharma Corporation 2-10, Doshomachi 3-chome Chuo-ku, Osaka-shi, JP	Sanofi-Aventis 174, Avenue de France, 75013 Paris, FR Mitsubishi Tanabe Pharma Corporation 2-6-18 Kitahama, Chuo-ku, Osaka-shi, Osaka 541-8505, JP	TE4A

PZ4A. EUROOPA PATENTIDE ÕIGUSLIKU STAATUSE MUUDATUSED

Eesti Patendi- lehe number	Regist- reeringu number	Rahvusvahelise patendiklassi- fikatsiooni indeksid	Viimasena enne muudatust patendiregistrisse kantud patendiomaniku andmed	Uue patendiomaniku andmed	Kood (WIPO ST. 17)
2006, 4	E000404	A61K 31/519 A61K 47/12 A61P 35/00	Pharmacia Italia S.p.A. Via Robert Koch, 1.2, 20152 Milano, IT	NERVIANO MEDICAL SCIENCES S.R.L. Viale Pasteur 10, 20014 Nerviano (Milano), IT	PC4A
2007, 2	E000978	G01N 33/569 G01N 33/92	Profos AG Josef-Engert-Strasse 9, 93053 Regensburg, DE	HYGLOS INVEST GmbH Am Neuland 1, 82347 Bernried, DE	PC4A
2008, 1	E001698	C12N 15/62 C07K 14/035 C12N 9/16 G01N 33/50	International Centre for Genetic Engineering and Biotechnology Area Science Park, Padriciano 99, 34012 Trieste, IT	ADRIACELL S.p.A. S.S. 14 KM 163,5, 34100 Trieste, IT	PC4A
2009, 3	E003054	A61K 31/4965 A61K 31/439 A61K 31/4015 A61K 31/405 A61K 31/497 C07C 311/37 C07D 241/04 C07D 453/02 C07D 207/40 C07D 403/06 C07D 487/04 C07D 401/04 C07D 243/08 C07D 403/04 C07D 207/34	Actimis Pharmaceuticals, Inc. 10835 Road to the Cure, Suite 200, San Diego, CA 92121, US	Axikin Pharmaceuticals, Inc. 10835 Road to the Cure, Suite 200, San Diego, CA 92121, US	PC4A
2009, 4	E003357	E06B 1/16	Lumon Oy Kaitilankatu 11, 45130 Kouvola, FI	Lumon Invest Oy Kaitilankatu 11, 45130 Kouvola, FI	PC4A

MZ4A. EUROOPA PATENTIDE KEHTIVUSE LÕPPEMINE EESTIS

Eesti Patendilehe number	Registreeringu number	Rahvusvahelise patendiklassifikatsiooni indeksid	Patendi kehtivuse lõppemise kuupäev	Kood (WIPO ST. 17)
2006, 3	E000308	A47B 1/04	30.06.2009	MM4A
2006, 5	E000528	C01B 37/06 C01B 37/08 C01B 39/54 B01J 29/84 B01J 29/85	31.05.2009	MM4A
2006, 5	E000554	C07J 51/00 A61K 31/58 A61P 35/00	31.05.2009	MM4A
2006, 6	E000643	B32B 11/02 B32B 11/08 E02B 17/00	31.05.2009	MM4A
2007, 1	E000750	A61K 31/765 A61K 31/44 A61P 31/04 A61P 29/00	30.06.2009	MM4A
2007, 1	E000795	C07D 307/26 C07D 493/04	30.06.2009	MM4A
2007, 1	E000804	C07H 17/08 A61K 31/7048	31.05.2009	MM4A
2007, 1	E000810	C08L 71/12 C08K 7/04 C08K 3/24 H01B 3/30	31.05.2009	MM4A
2007, 1	E000822	E04D 3/35 E04C 2/292 B29C 44/12	31.05.2009	MM4A
2007, 2	E000903	B65D 71/00	30.06.2009	MM4A
2007, 2	E000940	C07D 513/04 A61K 31/54 A61P 25/26	30.06.2009	MM4A
2007, 2	E000941	C07H 17/08 A61K 31/7048	31.05.2009	MM4A
2007, 2	E000942	C07H 17/08 A61K 31/70 A61P 31/04	31.05.2009	MM4A
2007, 2	E000943	C07J 1/00 A61K 31/565 A61P 5/34 A61P 15/16 A61P 15/18	31.05.2009	MM4A
2007, 2	E000964	E04C 2/54 E04C 1/42	30.06.2009	MM4A

Eesti Patendilehe number	Registreeringu number	Rahvusvahelise patendiklassifikatsiooni indeksid	Patendi kehtivuse lõppemise kuupäev	Kood (WIPO ST. 17)
2007, 3	E001065	C03B 9/353 C03B 9/40 C03B 9/16	30.06.2009	MM4A
2007, 3	E001105	C12N 15/68 C12N 15/74 C12N 15/64 A61K 39/112 A61K 39/02 A61K 35/74 A61K 48/00 C12N 1/36 C12R 1/42	31.05.2009	MM4A
2007, 3	E001122	F24C 3/08	30.06.2009	MM4A
2007, 4	E001176	A61K 31/662 A61K 31/343 A61P 25/00	30.06.2009	MM4A
2007, 4	E001217	C01B 33/158 B01J 13/00	30.06.2009	MM4A
2007, 5	E001376	C07D 487/04 A01N 43/90	31.05.2009	MM4A
2007, 5	E001387	C07K 14/315 A61K 39/385 C12N 5/10 C12N 15/62 C12N 15/63 A61K 38/16	30.06.2009	MM4A
2007, 5	E001396	C09D 201/02 C08G 65/28 C08G 71/04 C08G 18/38	31.05.2009	MM4A
2007, 6	E001532	C07H 15/04 C07D 498/18 A61F 2/02 A61K 31/436	31.05.2009	MM4A
2008, 2	E001756	A61K 31/44 A61K 31/192 A61P 9/10 A61P 3/10 A61P 3/06 C07C 323/20 C07D 213/30 C07D 213/32 C07C 59/66 C07C 59/68 C07D 213/34	30.06.2009	MM4A
2008, 2	E001861	F16D 13/28 F16D 23/12 F16D 27/00	31.05.2009	MM4A

Eesti Patendilehe number	Registreeringu number	Rahvusvahelise patendiklassifikatsiooni indeksid	Patendi kehtivuse lõppemise kuupäev	Kood (WIPO ST. 17)
2008, 3	E001915	A61K 31/19 A61P 3/06 A61P 3/10 C07C 323/62 C07C 235/20	30.06.2009	MM4A
2008, 3	E001955	B27D 1/00	30.06.2009	MM4A
2008, 3	E001964	B61L 21/00	30.06.2009	MM4A
2008, 3	E001976	C07C 235/34 C07C 323/62 A61K 31/19 A61P 3/06 A61P 3/10	30.06.2009	MM4A
2008, 3	E002012	C08G 18/68 C08G 18/44 C08G 18/08 C08G 18/12 C09D 175/14 C08G 18/66	30.06.2009	MM4A
2008, 3	E002045	G11B 33/04	30.06.2009	MM4A
2008, 4	E002081	A61K 31/216 A61K 31/11 A61P 35/00 A61P 35/02	30.06.2009	MM4A
2008, 4	E002101	A61M 5/28 A61M 5/32	31.05.2009	MM4A
2008, 5	E002286	B62K 15/00	30.06.2009	MM4A
2008, 5	E002354	E04F 10/06 F16B 9/00	31.05.2009	MM4A
2008, 5	E002361	F16H 61/00 F16H 63/06 F16H 55/56	30.06.2009	MM4A
2008, 6	E002411	A61K 9/70	31.05.2009	MM4A
2008, 6	E002440	A61K 35/76 A61P 25/04 A61P 29/00 A61P 35/00	31.05.2009	MM4A
2008, 6	E002479	B65D 71/40 B65D 71/42 B65D 71/46	31.05.2009	MM4A
2008, 6	E002511	C07D 401/12 C07D 417/12 A61K 31/506 A61P 25/16	31.05.2009	MM4A
2008, 6	E002565	E04H 1/12 E03D 9/00 E04B 1/348	30.06.2009	MM4A

Eesti Patendilehe number	Registreeringu number	Rahvusvahelise patendiklassifikatsiooni indeksid	Patendi kehtivuse lõppemise kuupäev	Kood (WIPO ST. 17)
2008, 6	E002579	G06K 9/50 G06K 9/00	30.06.2009	MM4A
2009, 1	E002668	A61M 35/00 A45D 34/04 B65D 83/00 B05C 17/00	31.05.2009	MM4A
2009, 1	E002752	C07K 14/18 C07K 14/135 A61K 39/155	30.06.2009	MM4A
2009, 2	E002826	A47J 43/07 A47J 43/08	30.06.2009	MM4A
2009, 2	E002939	C07D 487/22 A61K 41/00 A61K 33/30 A61P 31/04	31.05.2009	MM4A
2009, 2	E002943	C07D 495/04 C08G 61/12 H01B 1/12	31.05.2009	MM4A
2009, 3	E003203	H04B 7/005 H04Q 7/38	31.05.2009	MM4A

III OSA

MEDITSIINITOODETE JA TAIMEKAITSETOODETE TÄIENDAV KAITSE

AA1Y. TÄIENDAVA KAITSE TAOTLUSED

- (21) **C20090006**
(22) 18.12.2009
(71) AstraZeneca UK Ltd.
15 Stanhope Gate, London W1Y 6LN, GB
(68) 03482
(54) Kinasoliiniderivaadid, nende valmistamismeetod ja kasutamine
(92) K(2009)5203, 24.06.2009
(95) IRESSA
(74) Tõnu Nelsas
AAA Patendibüroo OÜ,
Tartu mnt 16, 10117 Tallinn, EE
-

- (21) **C20100001**
(22) 06.01.2010
(71) Movetis N.V.
Veedijk 58, B-2300 Turnhout, BE
(68) 03313
(54) Enterokineetiline bensamiid
(92) C(2009)8083, 15.10.2009
(95) Resolor - prukalopriid
(74) Harald Tehver
Patendibüroo Turvaja OÜ,
Liivalaia 22, 10118 Tallinn, EE
-

FG1Y. TÄIENDAVA KAITSE ANDMINE

- (11) **00027**
(94) 23.04.2021
(21) C20090006
(22) 18.12.2009
(71) AstraZeneca UK Ltd.
15 Stanhope Gate, London W1Y 6LN, GB
(68) 03482
(54) Kinasoliiniderivaadid, nende valmistamismeetod ja kasutamine
(92) K(2009)5203, 24.06.2009
(95) IRESSA
(74) Tõnu Nelsas
AAA Patendibüroo OÜ,
Tartu mnt 16, 10117 Tallinn, EE
-

V OSA LOENDID

BA1A. AVALDATUD PATENDITAOTLUSTE SÜSTEMAATILINE LOEND

Rahvusvahelise patendiklassifikatsiooni indeks	Patenditaotluse number
--	------------------------

A01H 4/00	P200800036	F01C 1/063	P200800041	G01N 27/447	P200800037
A61K 31/505	P200900043	F03G 7/00	P200800042	H03M 1/12	P200900083
C07H 19/00	P200800040	F24D 10/00	P200800046	H03M 1/12	P200900084
C30B 25/02	P200800038	G01N 21/64	P200800031		

FG4A. VÄLJAANTUD PATENTIDE SÜSTEMAATILINE LOEND

Rahvusvahelise patendiklassifikatsiooni indeks	Patendi number
--	----------------

A01N 1/00	05254	A61K 39/395	05263	C07D 471/04	05272
A01N 51/00	05255	A61K 47/12	05264	C07D 491/04	05273
A61K 9/20	05256	A61M 15/06	05265	C07J 1/00	05274
A61K 9/72	05257	B27K 3/15	05266	C09D 5/16	05275
A61K 31/4725	05258	C07C 311/21	05267	C12N 15/28	05276
A61K 31/56	05259	C07D 209/42	05268	D21H 17/66	05277
A61K 31/64	05260	C07D 239/94	05269	G01N 21/84	05278
A61K 33/24	05261	C07D 405/06	05270	G06Q 50/00	05279
A61K 38/22	05262	C07D 471/04	05271		

FG4A. VÄLJAANTUD PATENTIDE PATENDITAOTLUSTE NUMBRILINE LOEND

Patenditaotluse number	Patendi number
------------------------	----------------

P199900043	05276	P200200648	05261	P200300352	05266
P199900520	05277	P200300001	05268	P200300401	05275
P200000485	05255	P200300063	05273	P200300500	05272
P200100539	05264	P200300077	05269	P200300529	05267
P200200116	05262	P200300155	05259	P200300582	05263
P200200161	05258	P200300166	05271	P200400072	05278
P200200242	05260	P200300235	05256	P200400123	05265
P200200279	05254	P200300333	05270	P200700023	05279
P200200593	05257	P200300346	05274		

BB2A. AVALDATUD EUROOPA PATENDITAOTLUSTE PATENDINÕUDLUSE TÕLGETE NUMBRILINE LOEND

Patenditaotluse number	Patendinõudluse tõlke number
------------------------	------------------------------

09159736.9

0036

FG4A. EESTIS KEHTIVATE EUROOPA PATENTIDE SÜSTEMAATILINE LOEND

Rahvusvahelise patendiklassifikatsiooni indeks	Registreeringu number	Patendikirjelduse tõlke number
--	-----------------------	--------------------------------

A01B 73/02	E003726	EE-EP 1859665 B1	A61K 47/26	E003781	EE-EP 1988924 B1
A01K 13/00	E003727	EE-EP 1665927 B1	A61K 47/34	E003782	EE-EP 1893237 B1
A01N 43/653	E003728	EE-EP 1933623 B1	A61K 47/48	E003783	EE-EP 1463529 B1
A23C 9/13	E003729	EE-EP 1959746 B1	A61K 49/04	E003784	EE-EP 1575621 B1
A23L 1/01	E003730	EE-EP 1605774 B1	A61L 31/10	E003785	EE-EP 1937328 B1
A23L 1/0528	E003731	EE-EP 1927292 B1	A61M 5/145	E003786	EE-EP 1465689 B1
A23L 1/30	E003732	EE-EP 1758469 B1	A61M 15/00	E003787	EE-EP 1641508 B1
A23L 2/02	E003733	EE-EP 1679981 B1	A61P 31/18	E003788	EE-EP 1458447 B1
A24D 3/04	E003734	EE-EP 1889550 B1	A62C 4/00	E003789	EE-EP 1631358 B1
A24F 47/00	E003735	EE-EP 1827146 B1	A63B 71/12	E003790	EE-EP 1909928 B1
A41B 11/02	E003736	EE-EP 1796490 B1	B01D 29/00	E003791	EE-EP 1965885 B1
A47B 96/14	E003737	EE-EP 1872685 B1	B01D 63/06	E003792	EE-EP 1752207 B1
A47C 27/14	E003738	EE-EP 1956945 B1	B01J 20/22	E003793	EE-EP 1841527 B1
A47J 31/40	E003739	EE-EP 1867257 B1	B01J 20/34	E003794	EE-EP 1861198 B1
A61B 5/00	E003740	EE-EP 1694203 B1	B08B 9/032	E003795	EE-EP 1740323 B1
A61F 2/16	E003741	EE-EP 1980219 B1	B21B 1/46	E003796	EE-EP 1909980 B1
A61K 8/90	E003742	EE-EP 1993515 B1	B21D 31/04	E003797	EE-EP 1993754 B1
A61K 9/00	E003743	EE-EP 1978925 B1	B23K 35/14	E003798	EE-EP 1623791 B1
A61K 9/107	E003744	EE-EP 1648413 B1	B29C 63/26	E003799	EE-EP 1952973 B1
A61K 9/12	E003745	EE-EP 1694292 B1	B42C 9/00	E003800	EE-EP 1993851 B1
A61K 9/14	E003746	EE-EP 1991202 B1	B60C 11/16	E003801	EE-EP 1798069 B1
A61K 9/14	E003747	EE-EP 1765290 B1	B60J 5/04	E003802	EE-EP 1422095 B1
A61K 9/22	E003748	EE-EP 1803447 B1	B60R 11/02	E003803	EE-EP 1740416 B1
A61K 9/48	E003749	EE-EP 1853232 B1	B61L 1/20	E003804	EE-EP 1308365 B1
A61K 9/48	E003750	EE-EP 1898889 B1	B63H 25/38	E003805	EE-EP 2033891 B1
A61K 31/047	E003751	EE-EP 1744736 B1	B65B 31/02	E003806	EE-EP 1935789 B1
A61K 31/135	E003752	EE-EP 1833473 B1	B65D 17/50	E003807	EE-EP 1945522 B1
A61K 31/137	E003753	EE-EP 1728508 B1	B65D 71/00	E003808	EE-EP 1497198 B1
A61K 31/275	E003754	EE-EP 1896006 B1	B65D 83/14	E003809	EE-EP 1843954 B1
A61K 31/335	E003755	EE-EP 1814538 B1	B65D 85/10	E003810	EE-EP 1861324 B1
A61K 31/352	E003756	EE-EP 1973540 B1	B65H 75/44	E003811	EE-EP 2021269 B1
A61K 31/40	E003757	EE-EP 1898904 B1	C01F 17/00	E003812	EE-EP 1917214 B1
A61K 31/40	E003758	EE-EP 1971369 B1	C07C 51/09	E003813	EE-EP 1847524 B1
A61K 31/404	E003759	EE-EP 1791537 B1	C07C 213/08	E003814	EE-EP 1852415 B1
A61K 31/416	E003760	EE-EP 1651213 B1	C07C 227/16	E003815	EE-EP 1581475 B1
A61K 31/42	E003761	EE-EP 1817029 B1	C07C 227/32	E003816	EE-EP 1362845 B1
A61K 31/47	E003762	EE-EP 1711181 B1	C07C 233/18	E003817	EE-EP 1873140 B1
A61K 31/47	E003763	EE-EP 1513531 B1	C07C 233/41	E003818	EE-EP 1745010 B1
A61K 31/485	E003764	EE-EP 1897545 B1	C07C 309/65	E003819	EE-EP 1776336 B1
A61K 31/485	E003765	EE-EP 1838318 B1	C07D 209/30	E003820	EE-EP 1856045 B1
A61K 31/517	E003766	EE-EP 1463506 B1	C07D 211/20	E003821	EE-EP 1749818 B1
A61K 31/55	E003767	EE-EP 1814555 B1	C07D 211/90	E003822	EE-EP 1600441 B1
A61K 31/55	E003768	EE-EP 1572215 B1	C07D 215/56	E003823	EE-EP 1564210 B1
A61K 31/5513	E003769	EE-EP 1727551 B1	C07D 217/24	E003824	EE-EP 1501804 B1
A61K 31/70	E003770	EE-EP 1480653 B1	C07D 223/16	E003825	EE-EP 1838677 B1
A61K 31/7076	E003771	EE-EP 1891961 B1	C07D 235/28	E003826	EE-EP 1802584 B1
A61K 33/26	E003772	EE-EP 1848446 B1	C07D 239/48	E003827	EE-EP 1902037 B1
A61K 35/74	E003773	EE-EP 1782818 B1	C07D 241/20	E003828	EE-EP 1446387 B1
A61K 38/36	E003774	EE-EP 1691827 B1	C07D 261/20	E003829	EE-EP 1888541 B1
A61K 39/02	E003775	EE-EP 1523330 B1	C07D 333/24	E003830	EE-EP 1856090 B1
A61K 39/02	E003776	EE-EP 1651260 B1	C07D 401/04	E003831	EE-EP 1594858 B1
A61K 39/395	E003777	EE-EP 1624891 B1	C07D 401/12	E003832	EE-EP 1911756 B1
A61K 39/395	E003778	EE-EP 1933869 B1	C07D 407/04	E003833	EE-EP 1690862 B1
A61K 39/395	E003779	EE-EP 1482973 B1	C07D 417/14	E003834	EE-EP 1831209 B1
A61K 47/18	E003780	EE-EP 1420827 B1	C07D 453/02	E003835	EE-EP 1631569 B1

Rahvusvahelise patendiklassifikatsiooni indeks	Registreeringu number	Patendikirjelduse tõlke number
--	-----------------------	--------------------------------

C07D 471/04	E003836	EE-EP 1869038 B1	E01B 7/02	E003869	EE-EP 1516091 B1
C07D 471/04	E003837	EE-EP 1730144 B1	E01B 29/28	E003870	EE-EP 1931828 B1
C07D 471/04	E003838	EE-EP 1539753 B1	E04B 1/21	E003871	EE-EP 1532323 B1
C07D 471/04	E003839	EE-EP 1737859 B1	E04C 2/04	E003872	EE-EP 1355015 B1
C07D 471/04	E003840	EE-EP 1953161 B1	E04C 2/12	E003873	EE-EP 1532326 B1
C07D 471/18	E003841	EE-EP 1915375 B1	E04H 12/02	E003874	EE-EP 1415058 B1
C07D 491/22	E003842	EE-EP 1509529 B1	E04H 12/12	E003875	EE-EP 1876316 B1
C07D 491/22	E003843	EE-EP 1910376 B1	E05B 47/00	E003876	EE-EP 2016243 B1
C07D 501/56	E003844	EE-EP 1606293 B1	E05F 15/10	E003877	EE-EP 1365095 B1
C07F 5/02	E003845	EE-EP 1893622 B1	F03B 13/10	E003878	EE-EP 1440240 B1
C07H 21/02	E003846	EE-EP 1575977 B1	F03D 1/06	E003879	EE-EP 2018475 B1
C07J 41/00	E003847	EE-EP 1963355 B1	F16B 25/00	E003880	EE-EP 1971786 B1
C07K 5/00	E003848	EE-EP 1434791 B1	F16L 21/04	E003881	EE-EP 2000728 B1
C07K 5/08	E003849	EE-EP 1924593 B1	F16L 37/092	E003882	EE-EP 1800047 B1
C07K 7/06	E003850	EE-EP 1648925 B1	F16M 7/00	E003883	EE-EP 1581766 B1
C07K 7/06	E003851	EE-EP 1761553 B1	F21S 9/03	E003884	EE-EP 1818604 B1
C07K 14/50	E003852	EE-EP 1751184 B1	F23J 15/02	E003885	EE-EP 1747400 B1
C07K 14/50	E003853	EE-EP 1789442 B1	F42B 12/06	E003886	EE-EP 1745260 B1
C07K 14/54	E003854	EE-EP 1601694 B1	G01F 1/66	E003887	EE-EP 1840534 B1
C07K 14/75	E003855	EE-EP 1987063 B1	G01N 33/574	E003888	EE-EP 1861713 B1
C07K 14/78	E003856	EE-EP 1646653 B1	G01N 33/68	E003889	EE-EP 1991875 B1
C07K 16/24	E003857	EE-EP 1694705 B1	G01S 7/14	E003890	EE-EP 2047291 B1
C08J 9/00	E003858	EE-EP 1783161 B1	G02B 5/30	E003891	EE-EP 1724619 B1
C08K 13/02	E003859	EE-EP 2010601 B1	G02B 5/30	E003892	EE-EP 1722255 B1
C09D 7/14	E003860	EE-EP 1819783 B1	G05B 9/02	E003893	EE-EP 1788461 B1
C09K 11/06	E003861	EE-EP 1616929 B1	G07F 11/42	E003894	EE-EP 1730708 B1
C12N 9/02	E003862	EE-EP 1481056 B1	H01F 1/01	E003895	EE-EP 1415311 B1
C12N 15/31	E003863	EE-EP 1601770 B1	H01G 9/058	E003896	EE-EP 1678728 B1
C12N 15/49	E003864	EE-EP 1773999 B1	H01J 61/24	E003897	EE-EP 1953800 B1
C12N 15/54	E003865	EE-EP 1963510 B1	H02G 7/00	E003898	EE-EP 1826882 B1
C12N 15/82	E003866	EE-EP 1504104 B1	H04B 7/26	E003899	EE-EP 1730858 B1
C12Q 1/68	E003867	EE-EP 1576187 B1	H04L 12/28	E003900	EE-EP 1527565 B1
D01D 5/00	E003868	EE-EP 1673493 B1	H04R 25/00	E003901	EE-EP 1933590 B1

FG4A. EESTIS KEHTIVATE EUROOPA PATENTIDE NUMBRILINE LOEND

Registreeringu number	Patendikirjelduse tõlke number
-----------------------	--------------------------------

E003726	EE-EP 1859665 B1	E003742	EE-EP 1993515 B1	E003758	EE-EP 1971369 B1
E003727	EE-EP 1665927 B1	E003743	EE-EP 1978925 B1	E003759	EE-EP 1791537 B1
E003728	EE-EP 1933623 B1	E003744	EE-EP 1648413 B1	E003760	EE-EP 1651213 B1
E003729	EE-EP 1959746 B1	E003745	EE-EP 1694292 B1	E003761	EE-EP 1817029 B1
E003730	EE-EP 1605774 B1	E003746	EE-EP 1991202 B1	E003762	EE-EP 1711181 B1
E003731	EE-EP 1927292 B1	E003747	EE-EP 1765290 B1	E003763	EE-EP 1513531 B1
E003732	EE-EP 1758469 B1	E003748	EE-EP 1803447 B1	E003764	EE-EP 1897545 B1
E003733	EE-EP 1679981 B1	E003749	EE-EP 1853232 B1	E003765	EE-EP 1838318 B1
E003734	EE-EP 1889550 B1	E003750	EE-EP 1898889 B1	E003766	EE-EP 1463506 B1
E003735	EE-EP 1827146 B1	E003751	EE-EP 1744736 B1	E003767	EE-EP 1814555 B1
E003736	EE-EP 1796490 B1	E003752	EE-EP 1833473 B1	E003768	EE-EP 1572215 B1
E003737	EE-EP 1872685 B1	E003753	EE-EP 1728508 B1	E003769	EE-EP 1727551 B1
E003738	EE-EP 1956945 B1	E003754	EE-EP 1896006 B1	E003770	EE-EP 1480653 B1
E003739	EE-EP 1867257 B1	E003755	EE-EP 1814538 B1	E003771	EE-EP 1891961 B1
E003740	EE-EP 1694203 B1	E003756	EE-EP 1973540 B1	E003772	EE-EP 1848446 B1
E003741	EE-EP 1980219 B1	E003757	EE-EP 1898904 B1	E003773	EE-EP 1782818 B1

Registreeringu number	Patendikirjelduse tõlke number
-----------------------	--------------------------------

E003774	EE-EP 1691827 B1	E003817	EE-EP 1873140 B1	E003860	EE-EP 1819783 B1
E003775	EE-EP 1523330 B1	E003818	EE-EP 1745010 B1	E003861	EE-EP 1616929 B1
E003776	EE-EP 1651260 B1	E003819	EE-EP 1776336 B1	E003862	EE-EP 1481056 B1
E003777	EE-EP 1624891 B1	E003820	EE-EP 1856045 B1	E003863	EE-EP 1601770 B1
E003778	EE-EP 1933869 B1	E003821	EE-EP 1749818 B1	E003864	EE-EP 1773999 B1
E003779	EE-EP 1482973 B1	E003822	EE-EP 1600441 B1	E003865	EE-EP 1963510 B1
E003780	EE-EP 1420827 B1	E003823	EE-EP 1564210 B1	E003866	EE-EP 1504104 B1
E003781	EE-EP 1988924 B1	E003824	EE-EP 1501804 B1	E003867	EE-EP 1576187 B1
E003782	EE-EP 1893237 B1	E003825	EE-EP 1838677 B1	E003868	EE-EP 1673493 B1
E003783	EE-EP 1463529 B1	E003826	EE-EP 1802584 B1	E003869	EE-EP 1516091 B1
E003784	EE-EP 1575621 B1	E003827	EE-EP 1902037 B1	E003870	EE-EP 1931828 B1
E003785	EE-EP 1937328 B1	E003828	EE-EP 1446387 B1	E003871	EE-EP 1532323 B1
E003786	EE-EP 1465689 B1	E003829	EE-EP 1888541 B1	E003872	EE-EP 1355015 B1
E003787	EE-EP 1641508 B1	E003830	EE-EP 1856090 B1	E003873	EE-EP 1532326 B1
E003788	EE-EP 1458447 B1	E003831	EE-EP 1594858 B1	E003874	EE-EP 1415058 B1
E003789	EE-EP 1631358 B1	E003832	EE-EP 1911756 B1	E003875	EE-EP 1876316 B1
E003790	EE-EP 1909928 B1	E003833	EE-EP 1690862 B1	E003876	EE-EP 2016243 B1
E003791	EE-EP 1965885 B1	E003834	EE-EP 1831209 B1	E003877	EE-EP 1365095 B1
E003792	EE-EP 1752207 B1	E003835	EE-EP 1631569 B1	E003878	EE-EP 1440240 B1
E003793	EE-EP 1841527 B1	E003836	EE-EP 1869038 B1	E003879	EE-EP 2018475 B1
E003794	EE-EP 1861198 B1	E003837	EE-EP 1730144 B1	E003880	EE-EP 1971786 B1
E003795	EE-EP 1740323 B1	E003838	EE-EP 1539753 B1	E003881	EE-EP 2000728 B1
E003796	EE-EP 1909980 B1	E003839	EE-EP 1737859 B1	E003882	EE-EP 1800047 B1
E003797	EE-EP 1993754 B1	E003840	EE-EP 1953161 B1	E003883	EE-EP 1581766 B1
E003798	EE-EP 1623791 B1	E003841	EE-EP 1915375 B1	E003884	EE-EP 1818604 B1
E003799	EE-EP 1952973 B1	E003842	EE-EP 1509529 B1	E003885	EE-EP 1747400 B1
E003800	EE-EP 1993851 B1	E003843	EE-EP 1910376 B1	E003886	EE-EP 1745260 B1
E003801	EE-EP 1798069 B1	E003844	EE-EP 1606293 B1	E003887	EE-EP 1840534 B1
E003802	EE-EP 1422095 B1	E003845	EE-EP 1893622 B1	E003888	EE-EP 1861713 B1
E003803	EE-EP 1740416 B1	E003846	EE-EP 1575977 B1	E003889	EE-EP 1991875 B1
E003804	EE-EP 1308365 B1	E003847	EE-EP 1963355 B1	E003890	EE-EP 2047291 B1
E003805	EE-EP 2033891 B1	E003848	EE-EP 1434791 B1	E003891	EE-EP 1724619 B1
E003806	EE-EP 1935789 B1	E003849	EE-EP 1924593 B1	E003892	EE-EP 1722255 B1
E003807	EE-EP 1945522 B1	E003850	EE-EP 1648925 B1	E003893	EE-EP 1788461 B1
E003808	EE-EP 1497198 B1	E003851	EE-EP 1761553 B1	E003894	EE-EP 1730708 B1
E003809	EE-EP 1843954 B1	E003852	EE-EP 1751184 B1	E003895	EE-EP 1415311 B1
E003810	EE-EP 1861324 B1	E003853	EE-EP 1789442 B1	E003896	EE-EP 1678728 B1
E003811	EE-EP 2021269 B1	E003854	EE-EP 1601694 B1	E003897	EE-EP 1953800 B1
E003812	EE-EP 1917214 B1	E003855	EE-EP 1987063 B1	E003898	EE-EP 1826882 B1
E003813	EE-EP 1847524 B1	E003856	EE-EP 1646653 B1	E003899	EE-EP 1730858 B1
E003814	EE-EP 1852415 B1	E003857	EE-EP 1694705 B1	E003900	EE-EP 1527565 B1
E003815	EE-EP 1581475 B1	E003858	EE-EP 1783161 B1	E003901	EE-EP 1933590 B1
E003816	EE-EP 1362845 B1	E003859	EE-EP 2010601 B1		

FG4A. EESTIS KEHTIVATE EUROOPA PATENTIDE PATENDIKIRJELDUSE TÕLGETE NUMBRILINE LOEND

Patendikirjelduse tõlke number	Registreeringu number
--------------------------------	-----------------------

EE-EP 1308365 B1	E003804	EE-EP 1415311 B1	E003895	EE-EP 1446387 B1	E003828
EE-EP 1355015 B1	E003872	EE-EP 1420827 B1	E003780	EE-EP 1458447 B1	E003788
EE-EP 1362845 B1	E003816	EE-EP 1422095 B1	E003802	EE-EP 1463506 B1	E003766
EE-EP 1365095 B1	E003877	EE-EP 1434791 B1	E003848	EE-EP 1463529 B1	E003783
EE-EP 1415058 B1	E003874	EE-EP 1440240 B1	E003878	EE-EP 1465689 B1	E003786

Patendikirjelduse tõlke number	Registreeringu number				
EE-EP 1480653 B1	E003770	EE-EP 1730858 B1	E003899	EE-EP 1876316 B1	E003875
EE-EP 1481056 B1	E003862	EE-EP 1737859 B1	E003839	EE-EP 1888541 B1	E003829
EE-EP 1482973 B1	E003779	EE-EP 1740323 B1	E003795	EE-EP 1889550 B1	E003734
EE-EP 1497198 B1	E003808	EE-EP 1740416 B1	E003803	EE-EP 1891961 B1	E003771
EE-EP 1501804 B1	E003824	EE-EP 1744736 B1	E003751	EE-EP 1893237 B1	E003782
EE-EP 1504104 B1	E003866	EE-EP 1745010 B1	E003818	EE-EP 1893622 B1	E003845
EE-EP 1509529 B1	E003842	EE-EP 1745260 B1	E003886	EE-EP 1896006 B1	E003754
EE-EP 1513531 B1	E003763	EE-EP 1747400 B1	E003885	EE-EP 1897545 B1	E003764
EE-EP 1516091 B1	E003869	EE-EP 1749818 B1	E003821	EE-EP 1898889 B1	E003750
EE-EP 1523330 B1	E003775	EE-EP 1751184 B1	E003852	EE-EP 1898904 B1	E003757
EE-EP 1527565 B1	E003900	EE-EP 1752207 B1	E003792	EE-EP 1902037 B1	E003827
EE-EP 1532323 B1	E003871	EE-EP 1758469 B1	E003732	EE-EP 1909928 B1	E003790
EE-EP 1532326 B1	E003873	EE-EP 1761553 B1	E003851	EE-EP 1909980 B1	E003796
EE-EP 1539753 B1	E003838	EE-EP 1765290 B1	E003747	EE-EP 1910376 B1	E003843
EE-EP 1564210 B1	E003823	EE-EP 1773999 B1	E003864	EE-EP 1911756 B1	E003832
EE-EP 1572215 B1	E003768	EE-EP 1776336 B1	E003819	EE-EP 1915375 B1	E003841
EE-EP 1575621 B1	E003784	EE-EP 1782818 B1	E003773	EE-EP 1917214 B1	E003812
EE-EP 1575977 B1	E003846	EE-EP 1783161 B1	E003858	EE-EP 1924593 B1	E003849
EE-EP 1576187 B1	E003867	EE-EP 1788461 B1	E003893	EE-EP 1927292 B1	E003731
EE-EP 1581475 B1	E003815	EE-EP 1789442 B1	E003853	EE-EP 1931828 B1	E003870
EE-EP 1581766 B1	E003883	EE-EP 1791537 B1	E003759	EE-EP 1933590 B1	E003901
EE-EP 1594858 B1	E003831	EE-EP 1796490 B1	E003736	EE-EP 1933623 B1	E003728
EE-EP 1600441 B1	E003822	EE-EP 1798069 B1	E003801	EE-EP 1933869 B1	E003778
EE-EP 1601694 B1	E003854	EE-EP 1800047 B1	E003882	EE-EP 1935789 B1	E003806
EE-EP 1601770 B1	E003863	EE-EP 1802584 B1	E003826	EE-EP 1937328 B1	E003785
EE-EP 1605774 B1	E003730	EE-EP 1803447 B1	E003748	EE-EP 1945522 B1	E003807
EE-EP 1606293 B1	E003844	EE-EP 1814538 B1	E003755	EE-EP 1952973 B1	E003799
EE-EP 1616929 B1	E003861	EE-EP 1814555 B1	E003767	EE-EP 1953161 B1	E003840
EE-EP 1623791 B1	E003798	EE-EP 1817029 B1	E003761	EE-EP 1953800 B1	E003897
EE-EP 1624891 B1	E003777	EE-EP 1818604 B1	E003884	EE-EP 1956945 B1	E003738
EE-EP 1631358 B1	E003789	EE-EP 1819783 B1	E003860	EE-EP 1959746 B1	E003729
EE-EP 1631569 B1	E003835	EE-EP 1826882 B1	E003898	EE-EP 1963355 B1	E003847
EE-EP 1641508 B1	E003787	EE-EP 1827146 B1	E003735	EE-EP 1963510 B1	E003865
EE-EP 1646653 B1	E003856	EE-EP 1831209 B1	E003834	EE-EP 1965885 B1	E003791
EE-EP 1648413 B1	E003744	EE-EP 1833473 B1	E003752	EE-EP 1971369 B1	E003758
EE-EP 1648925 B1	E003850	EE-EP 1838318 B1	E003765	EE-EP 1971786 B1	E003880
EE-EP 1651213 B1	E003760	EE-EP 1838677 B1	E003825	EE-EP 1973540 B1	E003756
EE-EP 1651260 B1	E003776	EE-EP 1840534 B1	E003887	EE-EP 1978925 B1	E003743
EE-EP 1665927 B1	E003727	EE-EP 1841527 B1	E003793	EE-EP 1980219 B1	E003741
EE-EP 1673493 B1	E003868	EE-EP 1843954 B1	E003809	EE-EP 1987063 B1	E003855
EE-EP 1678728 B1	E003896	EE-EP 1847524 B1	E003813	EE-EP 1988924 B1	E003781
EE-EP 1679981 B1	E003733	EE-EP 1848446 B1	E003772	EE-EP 1991202 B1	E003746
EE-EP 1690862 B1	E003833	EE-EP 1852415 B1	E003814	EE-EP 1991875 B1	E003889
EE-EP 1691827 B1	E003774	EE-EP 1853232 B1	E003749	EE-EP 1993515 B1	E003742
EE-EP 1694203 B1	E003740	EE-EP 1856045 B1	E003820	EE-EP 1993754 B1	E003797
EE-EP 1694292 B1	E003745	EE-EP 1856090 B1	E003830	EE-EP 1993851 B1	E003800
EE-EP 1694705 B1	E003857	EE-EP 1859665 B1	E003726	EE-EP 2000728 B1	E003881
EE-EP 1711181 B1	E003762	EE-EP 1861198 B1	E003794	EE-EP 2010601 B1	E003859
EE-EP 1722255 B1	E003892	EE-EP 1861324 B1	E003810	EE-EP 2016243 B1	E003876
EE-EP 1724619 B1	E003891	EE-EP 1861713 B1	E003888	EE-EP 2018475 B1	E003879
EE-EP 1727551 B1	E003769	EE-EP 1867257 B1	E003739	EE-EP 2021269 B1	E003811
EE-EP 1728508 B1	E003753	EE-EP 1869038 B1	E003836	EE-EP 2033891 B1	E003805
EE-EP 1730144 B1	E003837	EE-EP 1872685 B1	E003737	EE-EP 2047291 B1	E003890
EE-EP 1730708 B1	E003894	EE-EP 1873140 B1	E003817		

AA1Y. TÄIENDA VA KAITSE TAOTLUSTE NUMBRILINE LOEND

Täiendava kaitse taotluse number	Aluspatendi number	Meditsiini- või taimekaitsetoote registreerimist tõendava dokumendi number
----------------------------------	--------------------	--

C20090006	03482	K(2009)5203
C20100001	03313	C(2009)8083

FG1Y. TÄIENDA VA KAITSE TUNNISTUSTE NUMBRILINE LOEND

Tunnistuse number	Täiendava kaitse taotluse number	Aluspatendi number	Meditsiini- või taimekaitsetoote registreerimist tõendava dokumendi number
-------------------	----------------------------------	--------------------	--

00027	C20090006	03482	K(2009)5203
-------	-----------	-------	-------------

AASTALOENDID

2009

BA1A. AVALDATUD PATENDITAOTLUSTE SÜSTEMAATILINE LOEND

Rahvusvahelise patendiklassifikatsiooni indeks(id)	Patenditaotluse number	Patendilehe number, kus avaldati patenditaotluse avaldamise teade			
A01N 25/00	P200900053	2009, 5	B21D 37/20	P200700046	2009, 2
A01N 35/10	P200900053	2009, 5	B23B 47/02	P200800005	2009, 5
A01N 39/04	P200900053	2009, 5	B23H 7/02	P200700046	2009, 2
A01N 43/40	P200900053	2009, 5	B23H 7/06	P200700046	2009, 2
A23L 1/30	P200800026	2009, 6	B25B 27/00	P200800003	2009, 4
A23L 1/30	P200800027	2009, 6	B25H 3/00	P200800066	2009, 3
A41D 19/015	P200800066	2009, 3	B25J 9/10	P200700028	2009, 1
A45F 3/14	P200800066	2009, 3	B25J 18/06	P200700028	2009, 1
A45F 5/00	P200800066	2009, 3	B29C 51/00	P200700035	2009, 1
A47K 3/20	P200800017	2009, 6	B29D 7/01	P200700062	2009, 4
A47K 3/28	P200800017	2009, 6	B29D 31/512	P200900035	2009, 4
A61B 5/00	P200900019	2009, 5	B32B 5/00	P200800011	2009, 5
A61F 2/08	P200700028	2009, 1	B41J 3/407	P200700035	2009, 1
A61K 8/29	P200700029	2009, 1	B41K 1/00	P200700035	2009, 1
A61K 31/16	P200800070	2009, 1	B60B 15/06	P200700027	2009, 1
A61K 31/4045	P200800070	2009, 1	B60B 19/02	P200700027	2009, 1
A61K 31/451	P200900004	2009, 2	B60R 25/00	P200700025	2009, 1
A61K 31/496	P200900004	2009, 2	B64C 9/00	P200700028	2009, 1
A61K 31/565	P200900049	2009, 5	B64C 13/50	P200700028	2009, 1
A61K 31/585	P200900049	2009, 5	B65G 33/00	P200800001	2009, 4
A61K 38/17	P200900067	2009, 6	B65G 33/08	P200800001	2009, 4
A61K 47/34	P200700053	2009, 3	B65G 33/14	P200800001	2009, 4
A61P 15/00	P200900049	2009, 5	B65G 33/26	P200800001	2009, 4
A61P 35/00	P200800070	2009, 1	B65G 33/34	P200800001	2009, 4
B01D 37/00	P200800002	2009, 4	B81B 3/00	P200900009	2009, 5
B01D 45/12	P200700049	2009, 2	B81B 3/00	P200900010	2009, 5
B01J 2/02	P200700039	2009, 1	B81B 3/00	P200900011	2009, 5
B01J 2/12	P200900069	2009, 6	B82B 1/00	P200900009	2009, 5
B01J 8/00	P200900050	2009, 5	B82B 1/00	P200900010	2009, 5
B01J 8/00	P200900070	2009, 6	B82B 1/00	P200900011	2009, 5
B01J 8/00	P200900071	2009, 6	C01B 3/16	P200900023	2009, 3
B01J 8/18	P200900071	2009, 6	C01B 31/02	P200800008	2009, 5
B01J 13/00	P200700032	2009, 1	C01B 31/08	P200700032	2009, 1
B01J 21/00	P200700029	2009, 1	C02F 1/00	P200800023	2009, 6
B01J 23/06	P200700024	2009, 1	C02F 1/461	P200800023	2009, 6
B01J 23/26	P200700024	2009, 1	C05C 1/02	P200700039	2009, 1
B01J 23/34	P200700024	2009, 1	C05G 1/08	P200700039	2009, 1
B01J 23/54	P200700024	2009, 1	C07C 29/149	P200800009	2009, 5
B01J 23/72	P200700024	2009, 1	C07C 241/02	P200900024	2009, 3
B01J 23/72	P200800009	2009, 5	C07C 243/40	P200900024	2009, 3
B01J 23/745	P200700024	2009, 1	C07D 211/18	P200900004	2009, 2
B01J 23/86	P200900023	2009, 3	C07D 295/073	P200900004	2009, 2
B01J 35/00	P200700029	2009, 1	C07D 295/096	P200900004	2009, 2
B01J 37/04	P200900023	2009, 3	C07D 295/155	P200900004	2009, 2
B04B 5/12	P200800053	2009, 2	C07H 21/00	P200900067	2009, 6
B04C 5/02	P200700049	2009, 2	C07H 21/04	P200800022	2009, 6
B04C 5/08	P200700049	2009, 2	C07K 14/435	P200900067	2009, 6
B04C 5/24	P200700049	2009, 2	C07K 14/47	P200900055	2009, 5
B09B 3/00	P200700024	2009, 1	C08G 63/08	P200700053	2009, 3

Rahvusvahelise patendiklassifikatsiooni indeks(id)	Patenditaotluse number	Patendilehe number, kus avaldati patenditaotluse avaldamise teade
--	------------------------	---

C08J 5/18	P200700062	2009, 4	F16H 15/04	P200800005	2009, 5
C08J 11/16	P200700024	2009, 1	F16H 15/08	P200800005	2009, 5
C10B 1/06	P200800020	2009, 6	F16H 15/44	P200800005	2009, 5
C10B 51/00	P200800020	2009, 6	F23C 10/10	P200900070	2009, 6
C10B 55/00	P200800020	2009, 6	F23C 10/32	P200900071	2009, 6
C10G 31/06	P200800002	2009, 4	F41C 33/00	P200800066	2009, 3
C10G 31/09	P200800002	2009, 4	G01N 21/01	P200700034	2009, 1
C12M 1/04	P200900029	2009, 3	G01N 27/22	P200800010	2009, 5
C12M 1/38	P200700034	2009, 1	G01R 27/26	P200800010	2009, 5
C12N 1/20	P200800026	2009, 6	G02B 6/00	P200700040	2009, 2
C12N 1/20	P200800027	2009, 6	G02B 6/00	P200800029	2009, 1
C12N 1/20	P200900029	2009, 3	G02B 6/00	P200800030	2009, 1
C12N 1/36	P200900028	2009, 3	G02B 6/00	P200800044	2009, 1
C12N 15/09	P200900028	2009, 3	G02B 21/28	P200700034	2009, 1
C12N 15/12	P200900055	2009, 5	G02B 21/30	P200700034	2009, 1
C12N 15/86	P200700047	2009, 2	G02B 26/00	P200800033	2009, 6
C12P 7/40	P200700037	2009, 1	G02B 26/10	P200700040	2009, 2
C12P 7/56	P200700037	2009, 1	G02B 26/10	P200800029	2009, 1
C12P 21/00	P200900028	2009, 3	G02B 26/10	P200800030	2009, 1
C12Q 1/68	P200800022	2009, 6	G02B 26/10	P200800044	2009, 1
C12R 1/19	P200900028	2009, 3	G02B 26/10	P200900009	2009, 5
C22B 9/10	P200700059	2009, 4	G02B 26/10	P200900010	2009, 5
C25B 9/06	P200800023	2009, 6	G02B 26/10	P200900011	2009, 5
C25B 13/00	P200800011	2009, 5	G02F 1/167	P200800033	2009, 6
C40B 40/06	P200700047	2009, 2	G06F 19/00	P200900019	2009, 5
E01B 27/04	P200900030	2009, 6	G06F 21/00	P200700036	2009, 1
E01B 27/10	P200900030	2009, 6	G06Q 30/00	P200900044	2009, 5
E01B 29/40	P200900030	2009, 6	G07C 9/00	P200700025	2009, 1
E01B 37/00	P200900030	2009, 6	G09F 9/37	P200800033	2009, 6
E03B 3/26	P200900012	2009, 2	G12B 21/00	P200700031	2009, 1
E03C 1/04	P200800017	2009, 6	G12B 21/08	P200700031	2009, 1
E05B 49/00	P200700025	2009, 1	G12B 21/22	P200700031	2009, 1
E21C 50/00	P200800053	2009, 2	H01H 51/08	P200900005	2009, 2
F03D 1/06	P200700038	2009, 1	H01H 51/08	P200900006	2009, 2
F03D 3/02	P200700060	2009, 4	H01M 4/00	P200800011	2009, 5
F03D 7/06	P200700060	2009, 4	H01M 8/00	P200700026	2009, 1
F03D 9/00	P200700038	2009, 1	H01M 8/10	P200700026	2009, 1
F03D 11/00	P200700038	2009, 1	H02K 7/18	P200700060	2009, 4
F03G 7/00	P200900009	2009, 5	H03F 1/34	P200700045	2009, 2
F03G 7/00	P200900010	2009, 5	H03F 3/34	P200700045	2009, 2
F03G 7/00	P200900011	2009, 5	H03F 3/45	P200700045	2009, 2
F16B 19/10	P200800003	2009, 4	H04L 29/06	P200700036	2009, 1
F16B 37/06	P200800003	2009, 4	H04L 29/06	P200700055	2009, 3
F16B 39/284	P200800003	2009, 4			

BA1A. AVALDATUD PATENDITAOTLUSTE NUMBRILINE LOEND

Patenditaotluse number	Rahvusvahelise patendiklassifikatsiooni indeks(id)	Patendilehe number, kus avaldati patenditaotluse avaldamise teade			
P200700024	B01J 23/06	2009, 1	P200700049	B01D 45/12	2009, 2
P200700024	B01J 23/26	2009, 1	P200700049	B04C 5/02	2009, 2
P200700024	B01J 23/34	2009, 1	P200700049	B04C 5/08	2009, 2
P200700024	B01J 23/54	2009, 1	P200700049	B04C 5/24	2009, 2
P200700024	B01J 23/72	2009, 1	P200700053	A61K 47/34	2009, 3
P200700024	B01J 23/745	2009, 1	P200700053	C08G 63/08	2009, 3
P200700024	B09B 3/00	2009, 1	P200700055	H04L 29/06	2009, 3
P200700024	C08J 11/16	2009, 1	P200700059	C22B 9/10	2009, 4
P200700025	B60R 25/00	2009, 1	P200700060	F03D 3/02	2009, 4
P200700025	E05B 49/00	2009, 1	P200700060	F03D 7/06	2009, 4
P200700025	G07C 9/00	2009, 1	P200700060	H02K 7/18	2009, 4
P200700026	H01M 8/00	2009, 1	P200700062	B29D 7/01	2009, 4
P200700026	H01M 8/10	2009, 1	P200700062	C08J 5/18	2009, 4
P200700027	B60B 15/06	2009, 1	P200800001	B65G 33/00	2009, 4
P200700027	B60B 19/02	2009, 1	P200800001	B65G 33/08	2009, 4
P200700028	A61F 2/08	2009, 1	P200800001	B65G 33/14	2009, 4
P200700028	B25J 9/10	2009, 1	P200800001	B65G 33/26	2009, 4
P200700028	B25J 18/06	2009, 1	P200800001	B65G 33/34	2009, 4
P200700028	B64C 9/00	2009, 1	P200800002	B01D 37/00	2009, 4
P200700028	B64C 13/50	2009, 1	P200800002	C10G 31/06	2009, 4
P200700029	A61K 8/29	2009, 1	P200800002	C10G 31/09	2009, 4
P200700029	B01J 21/00	2009, 1	P200800003	B25B 27/00	2009, 4
P200700029	B01J 35/00	2009, 1	P200800003	F16B 19/10	2009, 4
P200700031	G12B 21/00	2009, 1	P200800003	F16B 37/06	2009, 4
P200700031	G12B 21/08	2009, 1	P200800003	F16B 39/284	2009, 4
P200700031	G12B 21/22	2009, 1	P200800005	B23B 47/02	2009, 5
P200700032	B01J 13/00	2009, 1	P200800005	F16H 15/04	2009, 5
P200700032	C01B 31/08	2009, 1	P200800005	F16H 15/08	2009, 5
P200700034	C12M 1/38	2009, 1	P200800005	F16H 15/44	2009, 5
P200700034	G01N 21/01	2009, 1	P200800008	C01B 31/02	2009, 5
P200700034	G02B 21/28	2009, 1	P200800009	B01J 23/72	2009, 5
P200700034	G02B 21/30	2009, 1	P200800009	C07C 29/149	2009, 5
P200700035	B29C 51/00	2009, 1	P200800010	G01N 27/22	2009, 5
P200700035	B41J 3/407	2009, 1	P200800010	G01R 27/26	2009, 5
P200700035	B41K 1/00	2009, 1	P200800011	B32B 5/00	2009, 5
P200700036	G06F 21/00	2009, 1	P200800011	C25B 13/00	2009, 5
P200700036	H04L 29/06	2009, 1	P200800011	H01M 4/00	2009, 5
P200700037	C12P 7/40	2009, 1	P200800017	A47K 3/20	2009, 6
P200700037	C12P 7/56	2009, 1	P200800017	A47K 3/28	2009, 6
P200700038	F03D 1/06	2009, 1	P200800017	E03C 1/04	2009, 6
P200700038	F03D 9/00	2009, 1	P200800020	C10B 1/06	2009, 6
P200700038	F03D 11/00	2009, 1	P200800020	C10B 51/00	2009, 6
P200700039	B01J 2/02	2009, 1	P200800020	C10B 55/00	2009, 6
P200700039	C05C 1/02	2009, 1	P200800022	C07H 21/04	2009, 6
P200700039	C05G 1/08	2009, 1	P200800022	C12Q 1/68	2009, 6
P200700040	G02B 6/00	2009, 2	P200800023	C02F 1/00	2009, 6
P200700040	G02B 26/10	2009, 2	P200800023	C02F 1/461	2009, 6
P200700045	H03F 1/34	2009, 2	P200800023	C25B 9/06	2009, 6
P200700045	H03F 3/34	2009, 2	P200800026	A23L 1/30	2009, 6
P200700045	H03F 3/45	2009, 2	P200800026	C12N 1/20	2009, 6
P200700046	B21D 37/20	2009, 2	P200800027	A23L 1/30	2009, 6
P200700046	B23H 7/02	2009, 2	P200800027	C12N 1/20	2009, 6
P200700046	B23H 7/06	2009, 2	P200800029	G02B 6/00	2009, 1
P200700047	C12N 15/86	2009, 2	P200800029	G02B 26/10	2009, 1
P200700047	C40B 40/06	2009, 2	P200800030	G02B 6/00	2009, 1

Patenditaotluse number	Rahvusvahelise patendiklassifikatsiooni indeks(id)	Patendilehe number, kus avaldati patenditaotluse avaldamise teade
------------------------	--	---

P200800030	G02B 26/10	2009, 1	P200900019	G06F 19/00	2009, 5
P200800033	G02B 26/00	2009, 6	P200900023	B01J 23/86	2009, 3
P200800033	G02F 1/167	2009, 6	P200900023	B01J 37/04	2009, 3
P200800033	G09F 9/37	2009, 6	P200900023	C01B 3/16	2009, 3
P200800044	G02B 6/00	2009, 1	P200900024	C07C 241/02	2009, 3
P200800044	G02B 26/10	2009, 1	P200900024	C07C 243/40	2009, 3
P200800053	B04B 5/12	2009, 2	P200900028	C12N 1/36	2009, 3
P200800053	E21C 50/00	2009, 2	P200900028	C12N 15/09	2009, 3
P200800066	A41D 19/015	2009, 3	P200900028	C12P 21/00	2009, 3
P200800066	A45F 3/14	2009, 3	P200900028	C12R 1/19	2009, 3
P200800066	A45F 5/00	2009, 3	P200900029	C12M 1/04	2009, 3
P200800066	B25H 3/00	2009, 3	P200900029	C12N 1/20	2009, 3
P200800066	F41C 33/00	2009, 3	P200900030	E01B 27/04	2009, 6
P200800070	A61K 31/16	2009, 1	P200900030	E01B 27/10	2009, 6
P200800070	A61K 31/4045	2009, 1	P200900030	E01B 29/40	2009, 6
P200800070	A61P 35/00	2009, 1	P200900030	E01B 37/00	2009, 6
P200900004	A61K 31/451	2009, 2	P200900035	B29D 31/512	2009, 4
P200900004	A61K 31/496	2009, 2	P200900044	G06Q 30/00	2009, 5
P200900004	C07D 211/18	2009, 2	P200900049	A61K 31/565	2009, 5
P200900004	C07D 295/073	2009, 2	P200900049	A61K 31/585	2009, 5
P200900004	C07D 295/096	2009, 2	P200900049	A61P 15/00	2009, 5
P200900004	C07D 295/155	2009, 2	P200900050	B01J 8/00	2009, 5
P200900005	H01H 51/08	2009, 2	P200900053	A01N 25/00	2009, 5
P200900006	H01H 51/08	2009, 2	P200900053	A01N 35/10	2009, 5
P200900009	B81B 3/00	2009, 5	P200900053	A01N 39/04	2009, 5
P200900009	B82B 1/00	2009, 5	P200900053	A01N 43/40	2009, 5
P200900009	F03G 7/00	2009, 5	P200900055	C07K 14/47	2009, 5
P200900009	G02B 26/10	2009, 5	P200900055	C12N 15/12	2009, 5
P200900010	B81B 3/00	2009, 5	P200900067	A61K 38/17	2009, 6
P200900010	B82B 1/00	2009, 5	P200900067	C07H 21/00	2009, 6
P200900010	F03G 7/00	2009, 5	P200900067	C07K 14/435	2009, 6
P200900010	G02B 26/10	2009, 5	P200900069	B01J 2/12	2009, 6
P200900011	B81B 3/00	2009, 5	P200900070	B01J 8/00	2009, 6
P200900011	B82B 1/00	2009, 5	P200900070	F23C 10/10	2009, 6
P200900011	F03G 7/00	2009, 5	P200900071	B01J 8/00	2009, 6
P200900011	G02B 26/10	2009, 5	P200900071	B01J 8/18	2009, 6
P200900012	E03B 3/26	2009, 2	P200900071	F23C 10/32	2009, 6
P200900019	A61B 5/00	2009, 5			

**BA1A. AVALDATUD PATENDITAOTLUSTE PATENDITAOTLEJATE
TÄHESTIKULINE LOEND**

Patenditaotleja	Patenditaotluse number	Patendilehe number, kus avaldati patenditaotluse avaldamise teade			
Artec Design OÜ	P200700036	2009, 1	Outotec Oyj	P200900071	2009, 6
BASF Aktiengesellschaft	P200900053	2009, 5	Oy VR-Rata Ab	P200900030	2009, 6
Bayer Schering Pharma Aktiengesellschaft	P200900049	2009, 5	OÜ BALTOPTIK	P200800029	2009, 1
Carbon.ee OÜ	P200800008	2009, 5	OÜ Digital Fox Technology	P200700025	2009, 1
Chen, Ming-Te	P200900035	2009, 4	OÜ Eliko Tehnoloogia		
Chen, Ming-Te	P200900044	2009, 5	Arenduskeskus	P200700045	2009, 2
Dalhousie University	P200900067	2009, 6	OÜ GranuTeh Tootmine	P200700039	2009, 1
Eesti Energia Õlitööstus AS	P200700049	2009, 2	OÜ KSI Konsult	P200900019	2009, 5
Eesti Energia Õlitööstus AS	P200800001	2009, 4	OÜ Somins Studio Lux	P200700040	2009, 2
Eesti Maaviljeluse Instituut	P200800010	2009, 5	OÜ Somins Studio Lux	P200800030	2009, 1
Eesti Nanotehnoloogiate Arenduskeskuse AS	P200700029	2009, 1	OÜ Tervisliku Piima Biotehnoloogiate		
Eesti Nanotehnoloogiate Arenduskeskuse AS	P200700031	2009, 1	Arenduskeskus	P200800026	2009, 6
Eesti Nanotehnoloogiate Arenduskeskuse AS	P200700034	2009, 1	OÜ Tervisliku Piima Biotehnoloogiate		
Elcogen AS	P200700026	2009, 1	Arenduskeskus	P200800027	2009, 6
Fromdistance OÜ	P200700055	2009, 3	Petroleo Brasileiro S.A. - Petrobras	P200900050	2009, 5
HOBAS Engineering GmbH	P200900012	2009, 2	Reinmann, Erko	P200800066	2009, 3
Humal, Leo-Henn	P200700035	2009, 1	Rumjantsev, Raivo	P200800003	2009, 4
Iltšenko, Valeri	P200800023	2009, 6	Silva, Jorge	P200900024	2009, 3
Institut Kataliza imeni G.K. Borskova Sibirskogo Otdeleniya			Sominski, Igor	P200800029	2009, 1
Rossiiskoi Akademii Nauk	P200900023	2009, 3	Sominski, Igor	P200800030	2009, 1
Krimanov, Aleksander	P200800029	2009, 1	Sominski, Igor	P200800053	2009, 2
Krimanov, Aleksander	P200800030	2009, 1	Sominski, Igor	P200900009	2009, 5
Krimanov, Aleksander	P200800044	2009, 1	Sominski, Igor	P200900010	2009, 5
Krimanov, Aleksander	P200800053	2009, 2	Sominski, Igor	P200900011	2009, 5
Krimanov, Aleksander	P200900009	2009, 5	Sõnajalg, Andres	P200700038	2009, 1
Krimanov, Aleksander	P200900010	2009, 5	Sõnajalg, Oleg	P200700038	2009, 1
Krimanov, Aleksander	P200900011	2009, 5	Tallinna Tehnikakõrgkool	P200700046	2009, 2
Moeller			Tallinna Tehnikakõrgkool	P200700060	2009, 4
Gebäudeautomation KG	P200900005	2009, 2	Tallinna Tehnikakõrgkool	P200800005	2009, 5
Moeller			Tallinna Tehnikaülikool	P200700027	2009, 1
Gebäudeautomation KG	P200900006	2009, 2	Tallinna Tehnikaülikool	P200700032	2009, 1
NSAB, Filial af NeuroSearch			Tallinna Tehnikaülikool	P200700034	2009, 1
Sweden Ab, Sverige	P200900004	2009, 2	Tallinna Tehnikaülikool	P200700062	2009, 4
Nayda, Nikolay	P200800023	2009, 6	Tallinna Tehnikaülikool	P200900028	2009, 3
Neoqi AS	P200800017	2009, 6	Tallinna Tehnikaülikool	P200900029	2009, 3
Nordbiochem OÜ	P200700024	2009, 1	Tartu Ülikool	P200700028	2009, 1
Nordbiochem OÜ	P200700037	2009, 1	Tartu Ülikool	P200700029	2009, 1
Nordbiochem OÜ	P200700053	2009, 3	Tartu Ülikool	P200700031	2009, 1
Nordbiochem OÜ	P200800009	2009, 5	Tartu Ülikool	P200700034	2009, 1
Novartis AG	P200800070	2009, 1	Tartu Ülikool	P200700047	2009, 2
Otkrytoe Aktsionernoe Obshchestvo "Nauchno-Issledovatel'skiy i Proektny Institut Karbamida i Produktov Organicheskogo Sinteza" (OAO NIIK)	P200900069	2009, 6	Tartu Ülikool	P200800011	2009, 5
Outotec Oyj	P200900070	2009, 6	Terehrov, Mihhail	P200800022	2009, 6
			Visitret Displays OÜ	P200700059	2009, 4
			VKG OIL AS	P200800033	2009, 6
			VKG OIL AS	P200800002	2009, 4
			Yeda Research and Development Co. Ltd.	P200800020	2009, 6
				P200900055	2009, 5

FG4A. VÄLJAANTUD PATENTIDE SÜSTEMAATILINE LOEND

Rahvusvahelise patendiklassifikatsiooni indeks(id)	Patendi number	Patendilehe number, kus avaldati patendi väljaandmise teade
--	----------------	---

A01F 15/07	05145	2009, 2	A61K 31/085	05126	2009, 1
A01G 1/00	05188	2009, 4	A61K 31/09	05126	2009, 1
A01G 9/10	05188	2009, 4	A61K 31/135	05191	2009, 4
A01N 25/00	05122	2009, 1	A61K 31/135	05232	2009, 6
A01N 35/04	05227	2009, 6	A61K 31/136	05126	2009, 1
A01N 35/10	05122	2009, 1	A61K 31/137	05191	2009, 4
A01N 39/04	05122	2009, 1	A61K 31/137	05193	2009, 4
A01N 43/40	05122	2009, 1	A61K 31/137	05232	2009, 6
A01N 43/653	05227	2009, 6	A61K 31/155	05168	2009, 3
A01N 43/86	05246	2009, 6	A61K 31/155	05210	2009, 5
A01N 43/90	05246	2009, 6	A61K 31/165	05217	2009, 5
A01N 47/24	05227	2009, 6	A61K 31/166	05134	2009, 1
A23D 7/00	05189	2009, 4	A61K 31/166	05168	2009, 3
A23D 7/02	05189	2009, 4	A61K 31/167	05134	2009, 1
A23D 9/00	05189	2009, 4	A61K 31/167	05168	2009, 3
A23D 9/02	05189	2009, 4	A61K 31/175	05210	2009, 5
A23L 1/30	05173	2009, 3	A61K 31/18	05233	2009, 6
A23L 1/30	05189	2009, 4	A61K 31/195	05209	2009, 5
A23L 1/30	05209	2009, 5	A61K 31/197	05194	2009, 4
A61B 5/107	05228	2009, 6	A61K 31/20	05148	2009, 2
A61B 5/16	05228	2009, 6	A61K 31/20	05209	2009, 5
A61C 17/02	05229	2009, 6	A61K 31/202	05148	2009, 2
A61C 19/06	05229	2009, 6	A61K 31/216	05233	2009, 6
A61K 9/00	05123	2009, 1	A61K 31/23	05209	2009, 5
A61K 9/00	05146	2009, 2	A61K 31/24	05194	2009, 4
A61K 9/00	05209	2009, 5	A61K 31/325	05240	2009, 6
A61K 9/08	05124	2009, 1	A61K 31/33	05196	2009, 4
A61K 9/08	05175	2009, 3	A61K 31/337	05124	2009, 1
A61K 9/08	05230	2009, 6	A61K 31/357	05130	2009, 1
A61K 9/10	05147	2009, 2	A61K 31/357	05178	2009, 3
A61K 9/10	05191	2009, 4	A61K 31/36	05217	2009, 5
A61K 9/12	05167	2009, 3	A61K 31/38	05217	2009, 5
A61K 9/14	05146	2009, 2	A61K 31/40	05241	2009, 6
A61K 9/14	05190	2009, 4	A61K 31/401	05130	2009, 1
A61K 9/14	05221	2009, 5	A61K 31/4015	05185	2009, 3
A61K 9/16	05171	2009, 3	A61K 31/4015	05219	2009, 5
A61K 9/16	05190	2009, 4	A61K 31/4025	05241	2009, 6
A61K 9/16	05191	2009, 4	A61K 31/404	05192	2009, 4
A61K 9/16	05232	2009, 6	A61K 31/405	05234	2009, 6
A61K 9/19	05190	2009, 4	A61K 31/407	05125	2009, 1
A61K 9/19	05236	2009, 6	A61K 31/4164	05126	2009, 1
A61K 9/20	05221	2009, 5	A61K 31/4164	05175	2009, 3
A61K 9/20	05231	2009, 6	A61K 31/4184	05130	2009, 1
A61K 9/22	05221	2009, 5	A61K 31/4184	05175	2009, 3
A61K 9/22	05231	2009, 6	A61K 31/4188	05183	2009, 3
A61K 9/26	05191	2009, 4	A61K 31/4188	05202	2009, 4
A61K 9/26	05232	2009, 6	A61K 31/4192	05222	2009, 5
A61K 9/50	05147	2009, 2	A61K 31/42	05169	2009, 3
A61K 9/50	05171	2009, 3	A61K 31/422	05175	2009, 3
A61K 9/50	05190	2009, 4	A61K 31/4245	05194	2009, 4
A61K 9/51	05190	2009, 4	A61K 31/426	05194	2009, 4
A61K 9/58	05232	2009, 6	A61K 31/433	05194	2009, 4
A61K 9/60	05232	2009, 6	A61K 31/435	05130	2009, 1
A61K 31/00	05130	2009, 1	A61K 31/435	05211	2009, 5
A61K 31/047	05195	2009, 4	A61K 31/435	05217	2009, 5

Rahvusvahelise patendiklassifikatsiooni indeks(id)	Patendi number	Patendilehe number, kus avaldati patendi väljaandmise teade
--	----------------	---

A61K 31/4365	05127	2009, 1	A61K 31/616	05127	2009, 1
A61K 31/4365	05172	2009, 3	A61K 31/675	05158	2009, 2
A61K 31/437	05180	2009, 3	A61K 31/70	05137	2009, 1
A61K 31/437	05234	2009, 6	A61K 31/70	05184	2009, 3
A61K 31/4375	05234	2009, 6	A61K 31/7034	05184	2009, 3
A61K 31/438	05248	2009, 6	A61K 31/7052	05200	2009, 4
A61K 31/439	05149	2009, 2	A61K 31/7056	05202	2009, 4
A61K 31/439	05179	2009, 3	A61K 31/7076	05127	2009, 1
A61K 31/439	05183	2009, 3	A61K 31/7076	05185	2009, 3
A61K 31/44	05175	2009, 3	A61K 31/715	05202	2009, 4
A61K 31/4402	05240	2009, 6	A61K 31/727	05127	2009, 1
A61K 31/4406	05240	2009, 6	A61K 33/30	05209	2009, 5
A61K 31/4439	05175	2009, 3	A61K 35/32	05173	2009, 3
A61K 31/4439	05236	2009, 6	A61K 38/00	05158	2009, 2
A61K 31/444	05169	2009, 3	A61K 38/00	05190	2009, 4
A61K 31/444	05242	2009, 6	A61K 38/08	05172	2009, 3
A61K 31/445	05157	2009, 2	A61K 38/09	05172	2009, 3
A61K 31/445	05170	2009, 3	A61K 38/14	05172	2009, 3
A61K 31/451	05135	2009, 1	A61K 38/17	05212	2009, 5
A61K 31/451	05211	2009, 5	A61K 38/17	05213	2009, 5
A61K 31/46	05146	2009, 2	A61K 38/17	05235	2009, 6
A61K 31/46	05167	2009, 3	A61K 38/19	05174	2009, 3
A61K 31/46	05170	2009, 3	A61K 38/19	05201	2009, 4
A61K 31/4704	05167	2009, 3	A61K 38/21	05201	2009, 4
A61K 31/4709	05247	2009, 6	A61K 38/21	05214	2009, 5
A61K 31/485	05171	2009, 3	A61K 38/55	05127	2009, 1
A61K 31/495	05243	2009, 6	A61K 38/55	05130	2009, 1
A61K 31/496	05135	2009, 1	A61K 38/55	05213	2009, 5
A61K 31/496	05159	2009, 2	A61K 39/02	05139	2009, 1
A61K 31/496	05178	2009, 3	A61K 39/395	05213	2009, 5
A61K 31/496	05243	2009, 6	A61K 39/395	05235	2009, 6
A61K 31/497	05220	2009, 5	A61K 45/00	05185	2009, 3
A61K 31/4985	05180	2009, 3	A61K 45/00	05234	2009, 6
A61K 31/505	05150	2009, 2	A61K 45/06	05158	2009, 2
A61K 31/505	05221	2009, 5	A61K 45/06	05170	2009, 3
A61K 31/505	05244	2009, 6	A61K 45/06	05193	2009, 4
A61K 31/519	05181	2009, 3	A61K 47/02	05236	2009, 6
A61K 31/519	05222	2009, 5	A61K 47/04	05147	2009, 2
A61K 31/529	05183	2009, 3	A61K 47/04	05190	2009, 4
A61K 31/535	05183	2009, 3	A61K 47/04	05231	2009, 6
A61K 31/5377	05149	2009, 2	A61K 47/10	05175	2009, 3
A61K 31/5383	05147	2009, 2	A61K 47/10	05190	2009, 4
A61K 31/547	05199	2009, 4	A61K 47/12	05231	2009, 6
A61K 31/55	05182	2009, 3	A61K 47/14	05230	2009, 6
A61K 31/55	05230	2009, 6	A61K 47/14	05231	2009, 6
A61K 31/551	05130	2009, 1	A61K 47/18	05147	2009, 2
A61K 31/554	05158	2009, 2	A61K 47/18	05236	2009, 6
A61K 31/56	05123	2009, 1	A61K 47/22	05230	2009, 6
A61K 31/56	05167	2009, 3	A61K 47/24	05190	2009, 4
A61K 31/56	05186	2009, 3	A61K 47/26	05147	2009, 2
A61K 31/565	05128	2009, 1	A61K 47/26	05190	2009, 4
A61K 31/567	05172	2009, 3	A61K 47/32	05147	2009, 2
A61K 31/57	05129	2009, 1	A61K 47/32	05175	2009, 3
A61K 31/57	05167	2009, 3	A61K 47/32	05190	2009, 4
A61K 31/57	05172	2009, 3	A61K 47/32	05231	2009, 6
A61K 31/57	05186	2009, 3	A61K 47/34	05175	2009, 3
A61K 31/585	05128	2009, 1	A61K 47/34	05190	2009, 4

Rahvusvahelise patendiklassifikatsiooni indeks(id)	Patendi number	Patendilehe number, kus avaldati patendi väljaandmise teade
--	----------------	---

A61K 47/34	05214	2009, 5	A61P 11/06	05180	2009, 3
A61K 47/38	05147	2009, 2	A61P 11/06	05193	2009, 4
A61K 47/38	05190	2009, 4	A61P 11/08	05125	2009, 1
A61K 47/38	05232	2009, 6	A61P 11/14	05178	2009, 3
A61K 47/40	05190	2009, 4	A61P 13/02	05179	2009, 3
A61K 47/42	05190	2009, 4	A61P 13/02	05232	2009, 6
A61K 47/42	05202	2009, 4	A61P 13/10	05191	2009, 4
A61K 47/48	05201	2009, 4	A61P 13/10	05232	2009, 6
A61K 47/48	05214	2009, 5	A61P 13/12	05185	2009, 3
A61K 49/00	05176	2009, 3	A61P 15/00	05128	2009, 1
A61K 49/00	05245	2009, 6	A61P 15/00	05172	2009, 3
A61M 15/00	05167	2009, 3	A61P 15/08	05179	2009, 3
A61P 1/00	05149	2009, 2	A61P 15/10	05181	2009, 3
A61P 1/00	05232	2009, 6	A61P 15/12	05126	2009, 1
A61P 1/04	05182	2009, 3	A61P 17/00	05125	2009, 1
A61P 1/04	05209	2009, 5	A61P 17/00	05185	2009, 3
A61P 1/04	05234	2009, 6	A61P 17/00	05199	2009, 4
A61P 1/06	05179	2009, 3	A61P 17/06	05180	2009, 3
A61P 1/16	05124	2009, 1	A61P 19/02	05230	2009, 6
A61P 1/16	05194	2009, 4	A61P 19/10	05126	2009, 1
A61P 3/02	05209	2009, 5	A61P 21/04	05230	2009, 6
A61P 3/06	05125	2009, 1	A61P 25/00	05135	2009, 1
A61P 3/06	05150	2009, 2	A61P 25/00	05149	2009, 2
A61P 3/06	05158	2009, 2	A61P 25/00	05174	2009, 3
A61P 3/10	05130	2009, 1	A61P 25/00	05185	2009, 3
A61P 3/10	05199	2009, 4	A61P 25/00	05199	2009, 4
A61P 5/28	05186	2009, 3	A61P 25/00	05211	2009, 5
A61P 5/30	05126	2009, 1	A61P 25/00	05248	2009, 6
A61P 5/30	05129	2009, 1	A61P 25/02	05230	2009, 6
A61P 5/34	05186	2009, 3	A61P 25/04	05231	2009, 6
A61P 7/00	05149	2009, 2	A61P 25/04	05243	2009, 6
A61P 7/02	05127	2009, 1	A61P 25/16	05148	2009, 2
A61P 7/02	05168	2009, 3	A61P 25/16	05230	2009, 6
A61P 7/02	05169	2009, 3	A61P 25/18	05148	2009, 2
A61P 7/02	05187	2009, 3	A61P 25/18	05211	2009, 5
A61P 7/02	05194	2009, 4	A61P 25/18	05230	2009, 6
A61P 7/02	05222	2009, 5	A61P 25/22	05211	2009, 5
A61P 9/00	05194	2009, 4	A61P 25/22	05243	2009, 6
A61P 9/00	05199	2009, 4	A61P 25/24	05211	2009, 5
A61P 9/00	05217	2009, 5	A61P 25/28	05126	2009, 1
A61P 9/00	05248	2009, 6	A61P 25/28	05148	2009, 2
A61P 9/04	05130	2009, 1	A61P 25/28	05169	2009, 3
A61P 9/06	05179	2009, 3	A61P 25/28	05230	2009, 6
A61P 9/06	05196	2009, 4	A61P 25/32	05230	2009, 6
A61P 9/06	05220	2009, 5	A61P 29/00	05125	2009, 1
A61P 9/06	05240	2009, 6	A61P 29/00	05149	2009, 2
A61P 9/10	05130	2009, 1	A61P 29/00	05157	2009, 2
A61P 9/10	05150	2009, 2	A61P 29/00	05180	2009, 3
A61P 9/10	05169	2009, 3	A61P 29/00	05185	2009, 3
A61P 9/10	05185	2009, 3	A61P 29/00	05234	2009, 6
A61P 9/10	05222	2009, 5	A61P 29/00	05242	2009, 6
A61P 9/10	05233	2009, 6	A61P 31/00	05137	2009, 1
A61P 11/00	05157	2009, 2	A61P 31/00	05185	2009, 3
A61P 11/00	05159	2009, 2	A61P 31/04	05183	2009, 3
A61P 11/00	05185	2009, 3	A61P 31/04	05200	2009, 4
A61P 11/00	05199	2009, 4	A61P 31/04	05219	2009, 5
A61P 11/06	05179	2009, 3	A61P 31/12	05201	2009, 4

Rahvusvahelise patendiklassifikatsiooni indeks(id)	Patendi number	Patendilehe number, kus avaldati patendi väljaandmise teade
--	----------------	---

A61P 35/00	05124	2009, 1	C07B 57/00	05162	2009, 2
A61P 35/00	05137	2009, 1	C07B 61/00	05216	2009, 5
A61P 35/00	05184	2009, 3	C07C 27/02	05215	2009, 5
A61P 35/00	05199	2009, 4	C07C 43/225	05126	2009, 1
A61P 35/00	05201	2009, 4	C07C 43/23	05126	2009, 1
A61P 35/00	05212	2009, 5	C07C 57/60	05215	2009, 5
A61P 35/00	05235	2009, 6	C07C 61/40	05215	2009, 5
A61P 35/00	05241	2009, 6	C07C 67/14	05215	2009, 5
A61P 35/00	05244	2009, 6	C07C 67/347	05215	2009, 5
A61P 35/00	05247	2009, 6	C07C 67/56	05215	2009, 5
A61P 35/02	05137	2009, 1	C07C 69/013	05155	2009, 2
A61P 37/00	05134	2009, 1	C07C 69/013	05215	2009, 5
A61P 37/00	05199	2009, 4	C07C 69/618	05215	2009, 5
A61P 37/00	05201	2009, 4	C07C 69/74	05215	2009, 5
A61P 37/00	05213	2009, 5	C07C 209/56	05215	2009, 5
A61P 37/06	05185	2009, 3	C07C 209/58	05162	2009, 2
A61P 37/06	05190	2009, 4	C07C 209/86	05162	2009, 2
A61P 37/06	05233	2009, 6	C07C 211/40	05215	2009, 5
A61P 37/08	05125	2009, 1	C07C 213/00	05162	2009, 2
A61P 37/08	05185	2009, 3	C07C 213/02	05160	2009, 2
A61P 43/00	05168	2009, 3	C07C 215/08	05162	2009, 2
A61P 43/00	05182	2009, 3	C07C 215/50	05160	2009, 2
A61P 43/00	05199	2009, 4	C07C 217/10	05162	2009, 2
A61P 43/00	05201	2009, 4	C07C 217/20	05126	2009, 1
B01D 9/02	05131	2009, 1	C07C 227/10	05216	2009, 5
B01J 19/08	05151	2009, 2	C07C 229/38	05194	2009, 4
B02C 7/12	05237	2009, 6	C07C 233/01	05134	2009, 1
B02C 18/06	05152	2009, 2	C07C 233/64	05217	2009, 5
B02C 18/18	05152	2009, 2	C07C 233/65	05134	2009, 1
B02C 18/26	05152	2009, 2	C07C 233/88	05134	2009, 1
B24D 3/06	05140	2009, 1	C07C 235/08	05162	2009, 2
B24D 18/00	05140	2009, 1	C07C 235/34	05240	2009, 6
B31F 1/07	05153	2009, 2	C07C 235/44	05217	2009, 5
B31F 5/04	05153	2009, 2	C07C 235/46	05134	2009, 1
B32B 3/26	05153	2009, 2	C07C 237/30	05134	2009, 1
B32B 3/28	05153	2009, 2	C07C 237/30	05198	2009, 4
B32B 7/12	05153	2009, 2	C07C 247/22	05215	2009, 5
B32B 29/08	05153	2009, 2	C07C 253/30	05216	2009, 5
B63H 21/08	05177	2009, 3	C07C 255/23	05216	2009, 5
B65D 83/14	05167	2009, 3	C07C 271/22	05240	2009, 6
B67D 1/00	05132	2009, 1	C07C 277/08	05168	2009, 3
B67D 1/08	05132	2009, 1	C07C 279/14	05168	2009, 3
C01B 13/11	05151	2009, 2	C07C 311/19	05198	2009, 4
C01F 17/00	05140	2009, 1	C07D 205/04	05198	2009, 4
C05F 3/00	05238	2009, 6	C07D 207/34	05218	2009, 5
C05F 3/00	05239	2009, 6	C07D 207/34	05241	2009, 6
C05F 5/00	05188	2009, 4	C07D 207/42	05218	2009, 5
C05F 9/04	05133	2009, 1	C07D 207/44	05219	2009, 5
C05F 11/04	05188	2009, 4	C07D 209/12	05192	2009, 4
C05F 17/00	05154	2009, 2	C07D 209/16	05192	2009, 4
C05F 17/02	05133	2009, 1	C07D 209/18	05192	2009, 4
C05G 3/00	05188	2009, 4	C07D 209/20	05192	2009, 4
C05G 3/04	05238	2009, 6	C07D 209/88	05156	2009, 2
C05G 3/04	05239	2009, 6	C07D 211/14	05126	2009, 1
C07B 53/00	05216	2009, 5	C07D 211/18	05135	2009, 1
C07B 55/00	05162	2009, 2	C07D 211/34	05198	2009, 4
C07B 57/00	05159	2009, 2	C07D 211/58	05157	2009, 2

Rahvusvahelise patendiklassifikatsiooni indeks(id)	Patendi number	Patendilehe number, kus avaldati patendi väljaandmise teade
--	----------------	---

C07D 213/40	05168	2009, 3	C07D 317/28	05159	2009, 2
C07D 213/40	05198	2009, 4	C07D 317/28	05178	2009, 3
C07D 213/56	05217	2009, 5	C07D 317/44	05223	2009, 5
C07D 213/56	05220	2009, 5	C07D 317/46	05198	2009, 4
C07D 213/61	05242	2009, 6	C07D 317/60	05198	2009, 4
C07D 213/71	05196	2009, 4	C07D 317/60	05217	2009, 5
C07D 213/76	05198	2009, 4	C07D 317/66	05198	2009, 4
C07D 213/79	05240	2009, 6	C07D 317/72	05159	2009, 2
C07D 213/80	05181	2009, 3	C07D 319/08	05150	2009, 2
C07D 213/803	05136	2009, 1	C07D 319/18	05198	2009, 4
C07D 213/81	05220	2009, 5	C07D 333/20	05243	2009, 6
C07D 213/81	05240	2009, 6	C07D 333/24	05198	2009, 4
C07D 213/82	05136	2009, 1	C07D 333/24	05217	2009, 5
C07D 213/82	05220	2009, 5	C07D 333/34	05196	2009, 4
C07D 213/82	05240	2009, 6	C07D 333/66	05198	2009, 4
C07D 215/04	05195	2009, 4	C07D 401/04	05199	2009, 4
C07D 215/14	05195	2009, 4	C07D 401/06	05247	2009, 6
C07D 215/18	05195	2009, 4	C07D 401/12	05181	2009, 3
C07D 215/22	05195	2009, 4	C07D 401/12	05195	2009, 4
C07D 215/36	05195	2009, 4	C07D 401/12	05196	2009, 4
C07D 215/36	05196	2009, 4	C07D 401/12	05220	2009, 5
C07D 215/38	05195	2009, 4	C07D 403/04	05182	2009, 3
C07D 215/48	05195	2009, 4	C07D 403/14	05199	2009, 4
C07D 231/38	05181	2009, 3	C07D 405/00	05159	2009, 2
C07D 233/54	05198	2009, 4	C07D 405/00	05178	2009, 3
C07D 233/94	05243	2009, 6	C07D 405/04	05195	2009, 4
C07D 239/00	05222	2009, 5	C07D 405/06	05150	2009, 2
C07D 239/28	05168	2009, 3	C07D 405/12	05196	2009, 4
C07D 239/28	05220	2009, 5	C07D 405/12	05198	2009, 4
C07D 239/30	05194	2009, 4	C07D 405/12	05244	2009, 6
C07D 239/42	05150	2009, 2	C07D 405/12	05248	2009, 6
C07D 239/42	05221	2009, 5	C07D 405/14	05182	2009, 3
C07D 239/46	05223	2009, 5	C07D 409/04	05195	2009, 4
C07D 239/47	05223	2009, 5	C07D 409/12	05195	2009, 4
C07D 239/94	05244	2009, 6	C07D 409/12	05198	2009, 4
C07D 241/24	05220	2009, 5	C07D 409/14	05199	2009, 4
C07D 249/00	05222	2009, 5	C07D 413/04	05182	2009, 3
C07D 257/02	05245	2009, 6	C07D 413/12	05169	2009, 3
C07D 261/10	05196	2009, 4	C07D 413/12	05220	2009, 5
C07D 263/20	05197	2009, 4	C07D 413/14	05169	2009, 3
C07D 263/22	05197	2009, 4	C07D 417/04	05182	2009, 3
C07D 265/24	05246	2009, 6	C07D 417/12	05158	2009, 2
C07D 271/04	05194	2009, 4	C07D 417/14	05169	2009, 3
C07D 271/12	05196	2009, 4	C07D 417/14	05199	2009, 4
C07D 271/12	05198	2009, 4	C07D 451/04	05170	2009, 3
C07D 277/24	05194	2009, 4	C07D 451/10	05179	2009, 3
C07D 277/80	05198	2009, 4	C07D 453/02	05149	2009, 2
C07D 281/10	05158	2009, 2	C07D 453/06	05149	2009, 2
C07D 285/06	05194	2009, 4	C07D 471/04	05136	2009, 1
C07D 295/073	05135	2009, 1	C07D 471/04	05180	2009, 3
C07D 295/08	05194	2009, 4	C07D 471/04	05182	2009, 3
C07D 295/096	05135	2009, 1	C07D 471/04	05195	2009, 4
C07D 295/155	05135	2009, 1	C07D 471/10	05248	2009, 6
C07D 295/155	05243	2009, 6	C07D 475/06	05149	2009, 2
C07D 295/18	05198	2009, 4	C07D 487/04	05125	2009, 1
C07D 307/52	05198	2009, 4	C07D 487/04	05180	2009, 3
C07D 307/54	05198	2009, 4	C07D 487/04	05181	2009, 3
C07D 307/78	05217	2009, 5	C07D 487/04	05182	2009, 3
C07D 307/94	05248	2009, 6	C07D 487/04	05222	2009, 5

Rahvusvahelise patendiklassifikatsiooni indeks(id)	Patendi number	Patendilehe number, kus avaldati patendi väljaandmise teade
--	----------------	---

C07D 487/04	05223	2009, 5	C12N 15/09	05174	2009, 3
C07D 487/08	05183	2009, 3	C12N 15/09	05187	2009, 3
C07D 491/04	05195	2009, 4	C12N 15/10	05203	2009, 4
C07D 491/10	05248	2009, 6	C12N 15/62	05187	2009, 3
C07D 491/14	05131	2009, 1	C12N 15/70	05187	2009, 3
C07D 491/22	05131	2009, 1	C12N 15/863	05138	2009, 1
C07D 495/04	05195	2009, 4	C12P 17/10	05219	2009, 5
C07D 498/04	05182	2009, 3	C12P 19/26	05137	2009, 1
C07D 498/04	05246	2009, 6	C12P 19/60	05137	2009, 1
C07D 498/08	05183	2009, 3	C12P 21/02	05174	2009, 3
C07D 513/04	05149	2009, 2	C12P 21/02	05187	2009, 3
C07D 513/04	05182	2009, 3	C12P 41/00	05162	2009, 2
C07D 513/04	05246	2009, 6	C23F 1/28	05224	2009, 5
C07D 519/00	05180	2009, 3	C23G 1/02	05224	2009, 5
C07D 519/00	05248	2009, 6	C23G 1/08	05224	2009, 5
C07D 521/00	05199	2009, 4	E04D 1/34	05251	2009, 6
C07F 1/02	05245	2009, 6	E05B 9/02	05204	2009, 4
C07F 5/00	05245	2009, 6	E05B 15/02	05141	2009, 1
C07F 5/02	05240	2009, 6	E05B 15/02	05205	2009, 4
C07F 7/10	05195	2009, 4	E05B 19/00	05142	2009, 1
C07F 9/53	05150	2009, 2	E05B 19/06	05142	2009, 1
C07F 9/6512	05150	2009, 2	E05B 59/00	05204	2009, 4
C07F 9/6536	05158	2009, 2	E05B 63/00	05204	2009, 4
C07H 13/06	05184	2009, 3	E05D 15/48	05163	2009, 2
C07H 15/04	05202	2009, 4	E06B 3/46	05163	2009, 2
C07H 15/18	05184	2009, 3	F23G 5/033	05177	2009, 3
C07H 15/252	05155	2009, 2	F23K 1/00	05177	2009, 3
C07H 17/04	05137	2009, 1	F23K 3/00	05177	2009, 3
C07H 17/08	05200	2009, 4	G01B 5/02	05206	2009, 4
C07H 19/06	05249	2009, 6	G01B 5/18	05206	2009, 4
C07H 19/167	05185	2009, 3	G01B 5/24	05206	2009, 4
C07J 13/00	05186	2009, 3	G01B 21/30	05164	2009, 2
C07K 5/065	05158	2009, 2	G01F 1/58	05165	2009, 2
C07K 14/16	05138	2009, 1	G01N 21/01	05250	2009, 6
C07K 14/21	05187	2009, 3	G01N 33/569	05139	2009, 1
C07K 14/24	05187	2009, 3	G01S 5/14	05225	2009, 5
C07K 14/245	05187	2009, 3	G02B 21/28	05250	2009, 6
C07K 14/29	05139	2009, 1	G02B 21/30	05250	2009, 6
C07K 14/565	05201	2009, 4	G05B 15/00	05226	2009, 5
C07K 14/815	05187	2009, 3	G06K 7/00	05166	2009, 2
C07K 16/00	05201	2009, 4	G11B 7/0045	05252	2009, 6
C07K 19/00	05201	2009, 4	G11B 7/005	05207	2009, 4
C08B 37/00	05202	2009, 4	G11B 7/007	05207	2009, 4
C08F 8/32	05160	2009, 2	G11B 7/125	05252	2009, 6
C08G 77/46	05123	2009, 1	G11B 20/12	05207	2009, 4
C09K 3/14	05140	2009, 1	H01B 15/00	05144	2009, 1
C10B 1/04	05161	2009, 2	H01H 50/54	05143	2009, 1
C10B 53/06	05161	2009, 2	H01H 51/08	05143	2009, 1
C10G 1/02	05161	2009, 2	H01T 23/00	05151	2009, 2
C10J 3/20	05161	2009, 2	H02G 1/06	05144	2009, 1
C10L 1/22	05160	2009, 2	H02G 1/08	05144	2009, 1
C10L 1/222	05160	2009, 2	H03F 1/34	05253	2009, 6
C10L 1/238	05160	2009, 2	H03F 3/34	05253	2009, 6
C10L 10/04	05160	2009, 2	H03F 3/45	05253	2009, 6
C10M 159/16	05160	2009, 2	H04L 7/04	05166	2009, 2
C12M 1/38	05250	2009, 6	H04L 29/06	05208	2009, 4
C12N 9/02	05138	2009, 1	H04L 29/08	05208	2009, 4
C12N 9/02	05187	2009, 3	H04L 29/14	05208	2009, 4
C12N 9/12	05138	2009, 1			

FG4A. VÄLJAANTUD PATENTIDE NUMBRILINE LOEND

Patendi number	Rahvusvahelise patendiklassifikatsiooni indeks(id)	Patendilehe number, kus avaldati patendi väljaandmise teade
----------------	--	---

05122	A01N 25/00	2009, 1	05132	B67D 1/00	2009, 1
05122	A01N 35/10	2009, 1	05133	C05F 17/02	2009, 1
05122	A01N 39/04	2009, 1	05133	C05F 9/04	2009, 1
05122	A01N 43/40	2009, 1	05134	C07C 235/46	2009, 1
05123	A61K 9/00	2009, 1	05134	C07C 237/30	2009, 1
05123	A61K 31/56	2009, 1	05134	C07C 233/65	2009, 1
05123	C08G 77/46	2009, 1	05134	C07C 233/01	2009, 1
05124	A61K 31/337	2009, 1	05134	C07C 233/88	2009, 1
05124	A61K 9/08	2009, 1	05134	A61K 31/166	2009, 1
05124	A61P 1/16	2009, 1	05134	A61K 31/167	2009, 1
05124	A61P 35/00	2009, 1	05134	A61P 37/00	2009, 1
05125	A61K 31/407	2009, 1	05135	C07D 211/18	2009, 1
05125	A61P 3/06	2009, 1	05135	C07D 295/096	2009, 1
05125	A61P 11/08	2009, 1	05135	C07D 295/155	2009, 1
05125	A61P 17/00	2009, 1	05135	C07D 295/073	2009, 1
05125	A61P 29/00	2009, 1	05135	A61K 31/496	2009, 1
05125	A61P 37/08	2009, 1	05135	A61K 31/451	2009, 1
05125	C07D 487/04	2009, 1	05135	A61P 25/00	2009, 1
05126	A61K 31/4164	2009, 1	05136	C07D 471/04	2009, 1
05126	A61K 31/085	2009, 1	05136	C07D 213/803	2009, 1
05126	A61K 31/09	2009, 1	05136	C07D 213/82	2009, 1
05126	A61K 31/136	2009, 1	05137	C07H 17/04	2009, 1
05126	A61P 5/30	2009, 1	05137	C12P 19/60	2009, 1
05126	A61P 15/12	2009, 1	05137	C12P 19/26	2009, 1
05126	A61P 19/10	2009, 1	05137	A61K 31/70	2009, 1
05126	A61P 25/28	2009, 1	05137	A61P 35/00	2009, 1
05126	C07C 43/225	2009, 1	05137	A61P 35/02	2009, 1
05126	C07C 43/23	2009, 1	05137	A61P 31/00	2009, 1
05126	C07C 217/20	2009, 1	05138	C07K 14/16	2009, 1
05126	C07D 211/14	2009, 1	05138	C12N 9/02	2009, 1
05127	A61K 31/4365	2009, 1	05138	C12N 9/12	2009, 1
05127	A61K 31/616	2009, 1	05138	C12N 15/863	2009, 1
05127	A61K 31/7076	2009, 1	05139	C07K 14/29	2009, 1
05127	A61K 31/727	2009, 1	05139	G01N 33/569	2009, 1
05127	A61K 38/55	2009, 1	05139	A61K 39/02	2009, 1
05127	A61P 7/02	2009, 1	05140	C09K 3/14	2009, 1
05128	A61K 31/565	2009, 1	05140	B24D 3/06	2009, 1
05128	A61K 31/585	2009, 1	05140	B24D 18/00	2009, 1
05128	A61P 15/00	2009, 1	05140	C01F 17/00	2009, 1
05129	A61K 31/57	2009, 1	05141	E05B 15/02	2009, 1
05129	A61P 5/30	2009, 1	05142	E05B 19/00	2009, 1
05130	A61K 38/55	2009, 1	05142	E05B 19/06	2009, 1
05130	A61K 31/00	2009, 1	05143	H01H 51/08	2009, 1
05130	A61K 31/357	2009, 1	05143	H01H 50/54	2009, 1
05130	A61K 31/401	2009, 1	05144	H02G 1/06	2009, 1
05130	A61K 31/4184	2009, 1	05144	H01B 15/00	2009, 1
05130	A61K 31/435	2009, 1	05144	H02G 1/08	2009, 1
05130	A61K 31/551	2009, 1	05145	A01F 15/07	2009, 2
05130	A61P 9/04	2009, 1	05146	A61K 9/00	2009, 2
05130	A61P 9/10	2009, 1	05146	A61K 9/14	2009, 2
05130	A61P 3/10	2009, 1	05146	A61K 31/46	2009, 2
05131	B01D 9/02	2009, 1	05147	A61K 9/10	2009, 2
05131	C07D 491/14	2009, 1	05147	A61K 9/50	2009, 2
05131	C07D 491/22	2009, 1	05147	A61K 31/5383	2009, 2
05132	B67D 1/08	2009, 1	05147	A61K 47/04	2009, 2

Patendi number	Rahvusvahelise patendiklassifikatsiooni indeks(id)	Patendilehe number, kus avaldati patendi väljaandmise teade
----------------	--	---

05147	A61K 47/18	2009, 2	05159	C07D 317/28	2009, 2
05147	A61K 47/26	2009, 2	05159	C07D 405/00	2009, 2
05147	A61K 47/32	2009, 2	05159	C07B 57/00	2009, 2
05147	A61K 47/38	2009, 2	05159	A61K 31/496	2009, 2
05148	A61K 31/20	2009, 2	05159	A61P 11/00	2009, 2
05148	A61K 31/202	2009, 2	05160	C08F 8/32	2009, 2
05148	A61P 25/16	2009, 2	05160	C10L 1/22	2009, 2
05148	A61P 25/18	2009, 2	05160	C10L 1/222	2009, 2
05148	A61P 25/28	2009, 2	05160	C10L 1/238	2009, 2
05149	A61K 31/439	2009, 2	05160	C10L 10/04	2009, 2
05149	A61K 31/5377	2009, 2	05160	C10M 159/16	2009, 2
05149	A61P 1/00	2009, 2	05160	C07C 213/02	2009, 2
05149	A61P 7/00	2009, 2	05160	C07C 215/50	2009, 2
05149	A61P 25/00	2009, 2	05161	C10B 53/06	2009, 2
05149	A61P 29/00	2009, 2	05161	C10J 3/20	2009, 2
05149	C07D 453/02	2009, 2	05161	C10B 1/04	2009, 2
05149	C07D 453/06	2009, 2	05161	C10G 1/02	2009, 2
05149	C07D 475/06	2009, 2	05162	C12P 41/00	2009, 2
05149	C07D 513/04	2009, 2	05162	C07B 55/00	2009, 2
05150	A61K 31/505	2009, 2	05162	C07B 57/00	2009, 2
05150	A61P 3/06	2009, 2	05162	C07C 209/58	2009, 2
05150	A61P 9/10	2009, 2	05162	C07C 209/86	2009, 2
05150	C07D 239/42	2009, 2	05162	C07C 213/00	2009, 2
05150	C07D 405/06	2009, 2	05162	C07C 215/08	2009, 2
05150	C07F 9/53	2009, 2	05162	C07C 217/10	2009, 2
05150	C07F 9/6512	2009, 2	05162	C07C 235/08	2009, 2
05150	C07D 319/08	2009, 2	05163	E06B 3/46	2009, 2
05151	B01J 19/08	2009, 2	05163	E05D 15/48	2009, 2
05151	C01B 13/11	2009, 2	05164	G01B 21/30	2009, 2
05151	H01T 23/00	2009, 2	05165	G01F 1/58	2009, 2
05152	B02C 18/26	2009, 2	05166	H04L 7/04	2009, 2
05152	B02C 18/06	2009, 2	05166	G06K 7/00	2009, 2
05152	B02C 18/18	2009, 2	05167	A61K 9/12	2009, 3
05153	B31F 5/04	2009, 2	05167	A61K 31/56	2009, 3
05153	B31F 1/07	2009, 2	05167	A61K 31/46	2009, 3
05153	B32B 3/26	2009, 2	05167	A61K 31/4704	2009, 3
05153	B32B 3/28	2009, 2	05167	A61K 31/57	2009, 3
05153	B32B 7/12	2009, 2	05167	B65D 83/14	2009, 3
05153	B32B 29/08	2009, 2	05167	A61M 15/00	2009, 3
05154	C05F 17/00	2009, 2	05168	A61K 31/155	2009, 3
05155	C07C 69/013	2009, 2	05168	A61K 31/166	2009, 3
05155	C07H 15/252	2009, 2	05168	A61K 31/167	2009, 3
05156	C07D 209/88	2009, 2	05168	A61P 7/02	2009, 3
05157	C07D 211/58	2009, 2	05168	A61P 43/00	2009, 3
05157	A61K 31/445	2009, 2	05168	C07C 277/08	2009, 3
05157	A61P 11/00	2009, 2	05168	C07C 279/14	2009, 3
05157	A61P 29/00	2009, 2	05168	C07D 213/40	2009, 3
05158	C07D 281/10	2009, 2	05168	C07D 239/28	2009, 3
05158	C07D 417/12	2009, 2	05169	A61K 31/42	2009, 3
05158	C07F 9/6536	2009, 2	05169	A61K 31/444	2009, 3
05158	C07K 5/065	2009, 2	05169	A61P 7/02	2009, 3
05158	A61K 31/554	2009, 2	05169	A61P 9/10	2009, 3
05158	A61K 31/675	2009, 2	05169	A61P 25/28	2009, 3
05158	A61K 38/00	2009, 2	05169	C07D 413/12	2009, 3
05158	A61K 45/06	2009, 2	05169	C07D 413/14	2009, 3
05158	A61P 3/06	2009, 2	05169	C07D 417/14	2009, 3
05159	C07D 317/72	2009, 2	05170	A61K 31/445	2009, 3

Patendi number	Rahvusvahelise patendiklassifikatsiooni indeks(id)	Patendilehe number, kus avaldati patendi väljaandmise teade
----------------	--	---

05170	C07D 451/04	2009, 3	05181	C07D 231/38	2009, 3
05170	A61K 31/46	2009, 3	05181	C07D 213/80	2009, 3
05170	A61K 45/06	2009, 3	05182	C07D 487/04	2009, 3
05171	A61K 31/485	2009, 3	05182	A61K 31/55	2009, 3
05171	A61K 9/16	2009, 3	05182	A61P 1/04	2009, 3
05171	A61K 9/50	2009, 3	05182	A61P 43/00	2009, 3
05172	A61K 31/567	2009, 3	05182	C07D 403/04	2009, 3
05172	A61K 31/57	2009, 3	05182	C07D 405/14	2009, 3
05172	A61K 31/4365	2009, 3	05182	C07D 413/04	2009, 3
05172	A61K 38/08	2009, 3	05182	C07D 417/04	2009, 3
05172	A61K 38/09	2009, 3	05182	C07D 471/04	2009, 3
05172	A61K 38/14	2009, 3	05182	C07D 498/04	2009, 3
05172	A61P 15/00	2009, 3	05182	C07D 513/04	2009, 3
05173	A61K 35/32	2009, 3	05183	C07D 487/08	2009, 3
05173	A23L 1/30	2009, 3	05183	C07D 498/08	2009, 3
05174	A61K 38/19	2009, 3	05183	A61K 31/4188	2009, 3
05174	A61P 25/00	2009, 3	05183	A61K 31/439	2009, 3
05174	C12N 15/09	2009, 3	05183	A61K 31/529	2009, 3
05174	C12P 21/02	2009, 3	05183	A61K 31/535	2009, 3
05175	A61K 47/34	2009, 3	05183	A61P 31/04	2009, 3
05175	A61K 9/08	2009, 3	05184	C07H 13/06	2009, 3
05175	A61K 31/4164	2009, 3	05184	C07H 15/18	2009, 3
05175	A61K 31/4184	2009, 3	05184	A61K 31/70	2009, 3
05175	A61K 31/422	2009, 3	05184	A61K 31/7034	2009, 3
05175	A61K 31/44	2009, 3	05184	A61P 35/00	2009, 3
05175	A61K 31/4439	2009, 3	05185	C07H 19/167	2009, 3
05175	A61K 47/10	2009, 3	05185	A61K 31/4015	2009, 3
05175	A61K 47/32	2009, 3	05185	A61K 31/7076	2009, 3
05176	A61K 49/00	2009, 3	05185	A61K 45/00	2009, 3
05177	B63H 21/08	2009, 3	05185	A61P 9/10	2009, 3
05177	F23G 5/033	2009, 3	05185	A61P 11/00	2009, 3
05177	F23K 1/00	2009, 3	05185	A61P 13/12	2009, 3
05177	F23K 3/00	2009, 3	05185	A61P 17/00	2009, 3
05178	C07D 317/28	2009, 3	05185	A61P 25/00	2009, 3
05178	C07D 405/00	2009, 3	05185	A61P 29/00	2009, 3
05178	A61K 31/496	2009, 3	05185	A61P 31/00	2009, 3
05178	A61K 31/357	2009, 3	05185	A61P 37/06	2009, 3
05178	A61P 11/14	2009, 3	05185	A61P 37/08	2009, 3
05179	C07D 451/10	2009, 3	05186	C07J 13/00	2009, 3
05179	A61K 31/439	2009, 3	05186	A61K 31/56	2009, 3
05179	A61P 1/06	2009, 3	05186	A61K 31/57	2009, 3
05179	A61P 9/06	2009, 3	05186	A61P 5/28	2009, 3
05179	A61P 11/06	2009, 3	05186	A61P 5/34	2009, 3
05179	A61P 13/02	2009, 3	05187	C07K 14/815	2009, 3
05179	A61P 15/08	2009, 3	05187	C07K 14/24	2009, 3
05180	C07D 471/04	2009, 3	05187	C07K 14/21	2009, 3
05180	C07D 487/04	2009, 3	05187	C07K 14/245	2009, 3
05180	C07D 519/00	2009, 3	05187	C12N 9/02	2009, 3
05180	A61K 31/437	2009, 3	05187	C12N 15/09	2009, 3
05180	A61K 31/4985	2009, 3	05187	C12N 15/62	2009, 3
05180	A61P 11/06	2009, 3	05187	C12N 15/70	2009, 3
05180	A61P 17/06	2009, 3	05187	C12P 21/02	2009, 3
05180	A61P 29/00	2009, 3	05187	A61P 7/02	2009, 3
05181	C07D 487/04	2009, 3	05188	A01G 1/00	2009, 4
05181	A61K 31/519	2009, 3	05188	A01G 9/10	2009, 4
05181	A61P 15/10	2009, 3	05188	C05F 5/00	2009, 4
05181	C07D 401/12	2009, 3	05188	C05F 11/04	2009, 4

Patendi number	Rahvusvahelise patendiklassifikatsiooni indeks(id)	Patendilehe number, kus avaldati patendi väljaandmise teade
----------------	--	---

05188	C05G 3/00	2009, 4	05195	C07D 409/04	2009, 4
05189	A23L 1/30	2009, 4	05195	C07D 471/04	2009, 4
05189	A23D 7/00	2009, 4	05195	C07D 409/12	2009, 4
05189	A23D 7/02	2009, 4	05195	C07D 215/36	2009, 4
05189	A23D 9/00	2009, 4	05195	C07D 405/04	2009, 4
05189	A23D 9/02	2009, 4	05195	C07D 401/12	2009, 4
05190	A61K 9/50	2009, 4	05195	C07D 491/04	2009, 4
05190	A61K 9/14	2009, 4	05195	C07D 495/04	2009, 4
05190	A61K 9/16	2009, 4	05195	A61K 31/047	2009, 4
05190	A61K 9/19	2009, 4	05196	C07D 215/36	2009, 4
05190	A61K 9/51	2009, 4	05196	A61K 31/33	2009, 4
05190	A61K 38/00	2009, 4	05196	A61P 9/06	2009, 4
05190	A61K 47/04	2009, 4	05196	C07D 333/34	2009, 4
05190	A61K 47/10	2009, 4	05196	C07D 261/10	2009, 4
05190	A61K 47/24	2009, 4	05196	C07D 213/71	2009, 4
05190	A61K 47/26	2009, 4	05196	C07D 401/12	2009, 4
05190	A61K 47/32	2009, 4	05196	C07D 405/12	2009, 4
05190	A61K 47/34	2009, 4	05196	C07D 271/12	2009, 4
05190	A61K 47/38	2009, 4	05197	C07D 263/22	2009, 4
05190	A61K 47/40	2009, 4	05197	C07D 263/20	2009, 4
05190	A61K 47/42	2009, 4	05198	C07D 295/18	2009, 4
05190	A61P 37/06	2009, 4	05198	C07C 237/30	2009, 4
05191	A61K 31/135	2009, 4	05198	C07D 317/60	2009, 4
05191	A61K 31/137	2009, 4	05198	C07D 213/40	2009, 4
05191	A61K 9/10	2009, 4	05198	C07D 205/04	2009, 4
05191	A61K 9/26	2009, 4	05198	C07D 405/12	2009, 4
05191	A61K 9/16	2009, 4	05198	C07D 333/66	2009, 4
05191	A61P 13/10	2009, 4	05198	C07D 307/54	2009, 4
05192	A61K 31/404	2009, 4	05198	C07D 233/54	2009, 4
05192	C07D 209/12	2009, 4	05198	C07D 409/12	2009, 4
05192	C07D 209/16	2009, 4	05198	C07D 317/46	2009, 4
05192	C07D 209/18	2009, 4	05198	C07D 211/34	2009, 4
05192	C07D 209/20	2009, 4	05198	C07C 311/19	2009, 4
05193	A61K 45/06	2009, 4	05198	C07D 319/18	2009, 4
05193	A61K 31/137	2009, 4	05198	C07D 317/66	2009, 4
05193	A61P 11/06	2009, 4	05198	C07D 271/12	2009, 4
05194	C07C 229/38	2009, 4	05198	C07D 307/52	2009, 4
05194	C07D 239/30	2009, 4	05198	C07D 277/80	2009, 4
05194	C07D 271/04	2009, 4	05198	C07D 213/76	2009, 4
05194	C07D 277/24	2009, 4	05198	C07D 333/24	2009, 4
05194	C07D 285/06	2009, 4	05199	C07D 403/14	2009, 4
05194	C07D 295/08	2009, 4	05199	C07D 401/04	2009, 4
05194	A61K 31/197	2009, 4	05199	C07D 521/00	2009, 4
05194	A61K 31/24	2009, 4	05199	C07D 409/14	2009, 4
05194	A61K 31/4245	2009, 4	05199	C07D 417/14	2009, 4
05194	A61K 31/426	2009, 4	05199	A61K 31/547	2009, 4
05194	A61K 31/433	2009, 4	05199	A61P 3/10	2009, 4
05194	A61P 1/16	2009, 4	05199	A61P 9/00	2009, 4
05194	A61P 7/02	2009, 4	05199	A61P 11/00	2009, 4
05194	A61P 9/00	2009, 4	05199	A61P 17/00	2009, 4
05195	C07D 215/04	2009, 4	05199	A61P 25/00	2009, 4
05195	C07D 215/18	2009, 4	05199	A61P 35/00	2009, 4
05195	C07D 215/14	2009, 4	05199	A61P 37/00	2009, 4
05195	C07D 215/22	2009, 4	05199	A61P 43/00	2009, 4
05195	C07D 215/38	2009, 4	05200	C07H 17/08	2009, 4
05195	C07D 215/48	2009, 4	05200	A61K 31/7052	2009, 4
05195	C07F 7/10	2009, 4	05200	A61P 31/04	2009, 4

Patendi number	Rahvusvahelise patendiklassifikatsiooni indeks(id)	Patendilehe number, kus avaldati patendi väljaandmise teade
----------------	--	---

05201	C07K 14/565	2009, 4	05215	C07C 67/14	2009, 5
05201	A61K 38/19	2009, 4	05215	C07C 67/56	2009, 5
05201	A61K 38/21	2009, 4	05215	C07C 69/013	2009, 5
05201	A61K 47/48	2009, 4	05215	C07C 69/618	2009, 5
05201	A61P 31/12	2009, 4	05215	C07C 69/74	2009, 5
05201	A61P 35/00	2009, 4	05215	C07C 209/56	2009, 5
05201	A61P 37/00	2009, 4	05215	C07C 211/40	2009, 5
05201	A61P 43/00	2009, 4	05215	C07C 247/22	2009, 5
05201	C07K 16/00	2009, 4	05216	C07C 227/10	2009, 5
05201	C07K 19/00	2009, 4	05216	C07C 253/30	2009, 5
05202	C08B 37/00	2009, 4	05216	C07C 255/23	2009, 5
05202	A61K 31/4188	2009, 4	05216	C07B 53/00	2009, 5
05202	A61K 31/7056	2009, 4	05216	C07B 61/00	2009, 5
05202	A61K 31/715	2009, 4	05217	C07C 233/64	2009, 5
05202	A61K 47/42	2009, 4	05217	C07C 235/44	2009, 5
05202	C07H 15/04	2009, 4	05217	C07D 213/56	2009, 5
05203	C12N 15/10	2009, 4	05217	C07D 307/78	2009, 5
05204	E05B 9/02	2009, 4	05217	C07D 317/60	2009, 5
05204	E05B 63/00	2009, 4	05217	C07D 333/24	2009, 5
05204	E05B 59/00	2009, 4	05217	A61K 31/165	2009, 5
05205	E05B 15/02	2009, 4	05217	A61K 31/36	2009, 5
05206	G01B 5/02	2009, 4	05217	A61K 31/38	2009, 5
05206	G01B 5/18	2009, 4	05217	A61K 31/435	2009, 5
05206	G01B 5/24	2009, 4	05217	A61P 9/00	2009, 5
05207	G11B 7/005	2009, 4	05218	C07D 207/34	2009, 5
05207	G11B 7/007	2009, 4	05218	C07D 207/42	2009, 5
05207	G11B 20/12	2009, 4	05219	C07D 207/44	2009, 5
05208	H04L 29/06	2009, 4	05219	C12P 17/10	2009, 5
05208	H04L 29/08	2009, 4	05219	A61K 31/4015	2009, 5
05208	H04L 29/14	2009, 4	05219	A61P 31/04	2009, 5
05209	A61K 9/00	2009, 5	05220	C07D 213/81	2009, 5
05209	A61K 31/195	2009, 5	05220	C07D 213/82	2009, 5
05209	A61K 31/20	2009, 5	05220	C07D 239/28	2009, 5
05209	A61K 31/23	2009, 5	05220	C07D 241/24	2009, 5
05209	A61K 33/30	2009, 5	05220	C07D 213/56	2009, 5
05209	A23L 1/30	2009, 5	05220	C07D 401/12	2009, 5
05209	A61P 1/04	2009, 5	05220	C07D 413/12	2009, 5
05209	A61P 3/02	2009, 5	05220	A61K 31/497	2009, 5
05210	A61K 31/155	2009, 5	05220	A61P 9/06	2009, 5
05210	A61K 31/175	2009, 5	05221	C07D 239/42	2009, 5
05211	A61K 31/451	2009, 5	05221	A61K 9/20	2009, 5
05211	A61K 31/435	2009, 5	05221	A61K 9/14	2009, 5
05211	A61P 25/00	2009, 5	05221	A61K 9/22	2009, 5
05211	A61P 25/18	2009, 5	05221	A61K 31/505	2009, 5
05211	A61P 25/22	2009, 5	05222	C07D 487/04	2009, 5
05211	A61P 25/24	2009, 5	05222	A61K 31/4192	2009, 5
05212	A61K 38/17	2009, 5	05222	A61K 31/519	2009, 5
05212	A61P 35/00	2009, 5	05222	C07D 249/00	2009, 5
05213	A61K 39/395	2009, 5	05222	C07D 239/00	2009, 5
05213	A61K 38/17	2009, 5	05222	A61P 7/02	2009, 5
05213	A61K 38/55	2009, 5	05222	A61P 9/10	2009, 5
05213	A61P 37/00	2009, 5	05223	C07D 487/04	2009, 5
05214	A61K 47/48	2009, 5	05223	C07D 239/47	2009, 5
05214	A61K 47/34	2009, 5	05223	C07D 239/46	2009, 5
05214	A61K 38/21	2009, 5	05223	C07D 317/44	2009, 5
05215	C07C 67/347	2009, 5	05224	C23F 1/28	2009, 5
05215	C07C 27/02	2009, 5	05224	C23G 1/02	2009, 5
05215	C07C 57/60	2009, 5	05224	C23G 1/08	2009, 5
05215	C07C 61/40	2009, 5	05225	G01S 5/14	2009, 5

Patendi number	Rahvusvahelise patendiklassifikatsiooni indeks(id)	Patendilehe number, kus avaldati patendi väljaandmise teade
----------------	--	---

05226	G05B 15/00	2009, 5	05240	C07C 235/34	2009, 6
05227	A01N 35/04	2009, 6	05240	C07D 213/79	2009, 6
05227	A01N 47/24	2009, 6	05240	C07D 213/81	2009, 6
05227	A01N 43/653	2009, 6	05240	C07D 213/82	2009, 6
05228	A61B 5/16	2009, 6	05240	A61K 31/325	2009, 6
05228	A61B 5/107	2009, 6	05240	A61K 31/4402	2009, 6
05229	A61C 17/02	2009, 6	05240	A61K 31/4406	2009, 6
05229	A61C 19/06	2009, 6	05240	A61P 9/06	2009, 6
05230	A61K 9/08	2009, 6	05240	C07F 5/02	2009, 6
05230	A61K 31/55	2009, 6	05241	C07D 207/34	2009, 6
05230	A61K 47/14	2009, 6	05241	A61K 31/40	2009, 6
05230	A61K 47/22	2009, 6	05241	A61K 31/4025	2009, 6
05230	A61P 19/02	2009, 6	05241	A61P 35/00	2009, 6
05230	A61P 21/04	2009, 6	05242	C07D 213/61	2009, 6
05230	A61P 25/02	2009, 6	05242	A61K 31/444	2009, 6
05230	A61P 25/16	2009, 6	05242	A61P 29/00	2009, 6
05230	A61P 25/18	2009, 6	05243	C07D 233/94	2009, 6
05230	A61P 25/28	2009, 6	05243	C07D 295/155	2009, 6
05230	A61P 25/32	2009, 6	05243	C07D 333/20	2009, 6
05231	A61K 9/20	2009, 6	05243	A61K 31/495	2009, 6
05231	A61K 9/22	2009, 6	05243	A61K 31/496	2009, 6
05231	A61K 47/04	2009, 6	05243	A61P 25/04	2009, 6
05231	A61K 47/12	2009, 6	05243	A61P 25/22	2009, 6
05231	A61K 47/14	2009, 6	05244	C07D 239/94	2009, 6
05231	A61K 47/32	2009, 6	05244	C07D 405/12	2009, 6
05231	A61P 25/04	2009, 6	05244	A61K 31/505	2009, 6
05232	A61K 9/60	2009, 6	05244	A61P 35/00	2009, 6
05232	A61K 9/16	2009, 6	05245	C07D 257/02	2009, 6
05232	A61K 9/26	2009, 6	05245	C07F 1/02	2009, 6
05232	A61K 9/58	2009, 6	05245	C07F 5/00	2009, 6
05232	A61K 31/135	2009, 6	05245	A61K 49/00	2009, 6
05232	A61K 31/137	2009, 6	05246	C07D 265/24	2009, 6
05232	A61K 47/38	2009, 6	05246	C07D 498/04	2009, 6
05232	A61P 1/00	2009, 6	05246	C07D 513/04	2009, 6
05232	A61P 13/02	2009, 6	05246	A01N 43/86	2009, 6
05232	A61P 13/10	2009, 6	05246	A01N 43/90	2009, 6
05233	A61K 31/18	2009, 6	05247	C07D 401/06	2009, 6
05233	A61K 31/216	2009, 6	05247	A61P 35/00	2009, 6
05233	A61P 9/10	2009, 6	05247	A61K 31/4709	2009, 6
05233	A61P 37/06	2009, 6	05248	C07D 471/10	2009, 6
05234	A61K 31/437	2009, 6	05248	A61K 31/438	2009, 6
05234	A61K 31/4375	2009, 6	05248	A61P 9/00	2009, 6
05234	A61K 45/00	2009, 6	05248	A61P 25/00	2009, 6
05234	A61K 31/405	2009, 6	05248	C07D 491/10	2009, 6
05234	A61P 1/04	2009, 6	05248	C07D 519/00	2009, 6
05234	A61P 29/00	2009, 6	05248	C07D 307/94	2009, 6
05235	A61K 38/17	2009, 6	05248	C07D 405/12	2009, 6
05235	A61K 39/395	2009, 6	05249	C07H 19/06	2009, 6
05235	A61P 35/00	2009, 6	05250	C12M 1/38	2009, 6
05236	A61K 47/18	2009, 6	05250	G01N 21/01	2009, 6
05236	A61K 47/02	2009, 6	05250	G02B 21/28	2009, 6
05236	A61K 31/4439	2009, 6	05250	G02B 21/30	2009, 6
05236	A61K 9/19	2009, 6	05251	E04D 1/34	2009, 6
05237	B02C 7/12	2009, 6	05252	G11B 7/0045	2009, 6
05238	C05G 3/04	2009, 6	05252	G11B 7/125	2009, 6
05238	C05F 3/00	2009, 6	05253	H03F 1/34	2009, 6
05239	C05G 3/04	2009, 6	05253	H03F 3/34	2009, 6
05239	C05F 3/00	2009, 6	05253	H03F 3/45	2009, 6
05240	C07C 271/22	2009, 6			

FG4A. PATENDIOMANIKE TÄHESTIKULINE LOEND

Patendiomanik	Patendi number	Patendilehe number, kus avaldati patendi väljaandmise teade			
Abloy Oy	05205	2009, 4	Chiesi Farmaceutici S.p.A.	05167	2009, 3
Albireo AB	05158	2009, 2	Curozone Ireland, Ltd.	05229	2009, 6
Apoxis S.A.	05212	2009, 5	Dompé pha.r.ma s.p.a.	05159	2009, 2
AS Aswega	05165	2009, 2	Dompé pha.r.ma s.p.a.	05178	2009, 3
ASSA AB	05141	2009, 1	Dompé pha.r.ma s.p.a.	05233	2009, 6
ASSA AB	05204	2009, 4	Eesti Nanotehnoloogiateg		
AstraZeneca AB	05127	2009, 1	Arenduskeskuse AS	05250	2009, 6
AstraZeneca AB	05134	2009, 1	Euro-Celtique S.A.	05171	2009, 3
AstraZeneca AB	05136	2009, 1	Fermentas UAB	05203	2009, 4
AstraZeneca AB	05149	2009, 2	Fresenius Kabi Deutschland GmbH	05209	2009, 5
AstraZeneca AB	05150	2009, 2	Friedrich Ossenberg-Schule &		
AstraZeneca AB	05157	2009, 2	Söhne GmbH & Co. KG	05251	2009, 6
AstraZeneca AB	05175	2009, 3	GSF-Forschungszentrum für		
AstraZeneca AB	05215	2009, 5	Umwelt und Gesundheit GmbH	05138	2009, 1
AstraZeneca AB	05221	2009, 5	Heineken Technical Services B.V.	05132	2009, 1
AstraZeneca AB	05222	2009, 5	Hormos Medical Corporation	05126	2009, 1
AstraZeneca AB	05223	2009, 5	Janssen Pharmaceutica N.V.	05182	2009, 3
AstraZeneca AB	05234	2009, 6	Janssen Pharmaceutica N.V.	05195	2009, 4
AstraZeneca AB	05243	2009, 6	Janssen Pharmaceutica N.V.	05230	2009, 6
Avenira Oy	05153	2009, 2	Janssen Pharmaceutica N.V.	05247	2009, 6
Aventis Pharma Limited	05180	2009, 3	Kaba GmbH	05142	2009, 1
Aventis Pharma S.A.	05124	2009, 1	Kekkilä Oyj	05188	2009, 4
Avesta Welding Aktiebolag	05224	2009, 5	Koninklijke Philips Electronics		
Banyu Pharmaceutical Co., Ltd.	05248	2009, 6	N.V.	05207	2009, 4
BASF Aktiengesellschaft	05122	2009, 1	Koninklijke Philips Electronics		
BASF Aktiengesellschaft	05160	2009, 2	N.V.	05252	2009, 6
BASF Aktiengesellschaft	05162	2009, 2	Laboratoires Serono SA	05174	2009, 3
BASF Aktiengesellschaft	05227	2009, 6	Laboratoires Serono SA	05214	2009, 5
BASF Aktiengesellschaft	05246	2009, 6	Laxdale Limited	05148	2009, 2
Bayer Schering Pharma Aktiengesellschaft	05128	2009, 1	Lutšin, Mark	05228	2009, 6
Bayer Schering Pharma Aktiengesellschaft	05169	2009, 3	Menarini Ricerche S.p.A.	05155	2009, 2
Bayer Schering Pharma Aktiengesellschaft	05172	2009, 3	Menarini Ricerche S.p.A.	05249	2009, 6
Bayer Schering Pharma Aktiengesellschaft	05194	2009, 4	Merck & Co., Inc.	05242	2009, 6
Bayer Schering Pharma Oy	05123	2009, 1	Merckle GmbH	05125	2009, 1
Berlex Laboratories, Inc.	05199	2009, 4	Mitsui Mining & Smelting Co., Ltd.	05140	2009, 1
Berlin-Chemie AG	05249	2009, 6	Moeller Gebäudeautomation KG	05143	2009, 1
Biogen Idec MA Inc.	05201	2009, 4	Nerviano Medical Sciences S.r.l.	05218	2009, 5
Biogen Idec MA Inc.	05212	2009, 5	Nerviano Medical Sciences S.r.l.	05241	2009, 6
Biogen Idec MA Inc.	05213	2009, 5	Neurim Pharmaceuticals (1991)		
Biogen Idec MA Inc.	05235	2009, 6	Ltd.	05192	2009, 4
Boehringer Ingelheim Pharma GmbH & Co. KG	05131	2009, 1	New York University	05235	2009, 6
Boehringer Ingelheim Pharma GmbH & Co. KG	05146	2009, 2	Nilsson, Kenneth	05139	2009, 1
Boehringer Ingelheim Pharma GmbH & Co. KG	05179	2009, 3	NOVEXEL	05183	2009, 3
Boehringer Ingelheim Pharma GmbH & Co. KG	05193	2009, 4	NSAB, Filial af NeuroSearch		
Boehringer Ingelheim Pharma GmbH & Co. KG	05244	2009, 6	Sweden Ab, Sverige	05135	2009, 1
Bristol-Myers Squibb Company	05210	2009, 5	Nycomed GmbH	05236	2009, 6
			Olson, Bengt Krister	05173	2009, 3
			Ortho-McNeil Pharmaceutical, Inc.	05147	2009, 2
			OÜ Eliko Tehnoloogia		
			Arenduskeskus	05166	2009, 2
			OÜ Eliko Tehnoloogia		
			Arenduskeskus	05253	2009, 6
			Ozonator Limited	05151	2009, 2
			Pählson, Carl	05139	2009, 1
			Pfizer Inc.	05170	2009, 3

Patendiomanik	Patendi number	Patendilehe number, kus avaldati patendi väljaandmise teade
---------------	----------------	---

Pfizer Inc.	05181	2009, 3	Shionogi & Co. Ltd.	05150	2009, 2
Pharmacia & Upjohn Company	05197	2009, 4	Skye-Pharma Canada Inc.	05190	2009, 4
Pharmacia AB	05191	2009, 4	Svenska Uterum AB	05163	2009, 2
Pharmacia AB	05232	2009, 6	Tallinna Tehnikaülikool	05152	2009, 2
Pharmacopeia, Inc.	05199	2009, 4	Tallinna Tehnikaülikool	05161	2009, 2
Pichler, Alois	05144	2009, 1	Tallinna Tehnikaülikool	05164	2009, 2
Pohjola, Pekka	05133	2009, 1	Tallinna Tehnikaülikool	05166	2009, 2
Pohjola, Pekka	05154	2009, 2	Tallinna Tehnikaülikool	05206	2009, 4
Renesanse Plus, Sia	05226	2009, 5	Tallinna Tehnikaülikool	05237	2009, 6
Sandoz AG	05200	2009, 4	Tallinna Tehnikaülikool	05250	2009, 6
Sanofi-Aventis	05198	2009, 4	Tartu Ülikool	05250	2009, 6
Sanofi-Aventis	05202	2009, 4	Telia AB	05208	2009, 4
Sanofi-Aventis	05211	2009, 5	Telia AB	05225	2009, 5
Sanofi-Aventis Deutschland GmbH	05130	2009, 1	Teriaka OY	05189	2009, 4
Sanofi-Aventis Deutschland GmbH	05137	2009, 1	University of Virginia Patent Foundation	05185	2009, 3
Sanofi-Aventis Deutschland GmbH	05168	2009, 3	Vakhterova, Nelli	05228	2009, 6
Sanofi-Aventis Deutschland GmbH	05184	2009, 3	Vernalis Limited	05156	2009, 2
Sanofi-Aventis Deutschland GmbH	05187	2009, 3	Viru Ramm OÜ	05238	2009, 6
Sanofi-Aventis Deutschland GmbH	05196	2009, 4	Viru Ramm OÜ	05239	2009, 6
Sanofi-Aventis Deutschland GmbH	05217	2009, 5	Warner-Lambert Company	05216	2009, 5
Sanofi-Aventis Deutschland GmbH	05219	2009, 5	Welmount Limited	05145	2009, 2
Sanofi-Aventis Deutschland GmbH	05220	2009, 5	Worldwide Ecological Shipping & Transport - WEST	05177	2009, 3
Sanofi-Aventis Deutschland GmbH	05240	2009, 6	Wyeth	05129	2009, 1
Schering AG	05186	2009, 3	Zentiva, a.s.	05231	2009, 6
Schering Aktiengesellschaft	05176	2009, 3			
Schering Aktiengesellschaft	05245	2009, 6			

FG4A. VÄLJAANTUD PATENTIDE PATENDITAOTLUSTE NUMBRILINE LOEND

Patenditaotluse number	Patendi number	Patendilehe number, kus avaldati patendi väljaandmise teade
------------------------	----------------	---

P199900146	05213	2009, 5	P200200085	05130	2009, 1
P200000446	05235	2009, 6	P200200087	05124	2009, 1
P200000478	05139	2009, 1	P200200091	05199	2009, 4
P200000498	05189	2009, 4	P200200104	05172	2009, 3
P200000597	05156	2009, 2	P200200110	05128	2009, 1
P200000614	05214	2009, 5	P200200130	05194	2009, 4
P200100254	05232	2009, 6	P200200139	05187	2009, 3
P200100269	05190	2009, 4	P200200152	05176	2009, 3
P200100332	05207	2009, 4	P200200164	05203	2009, 4
P200100345	05170	2009, 3	P200200181	05212	2009, 5
P200100397	05185	2009, 3	P200200184	05160	2009, 2
P200100430	05150	2009, 2	P200200190	05126	2009, 1
P200100471	05151	2009, 2	P200200195	05181	2009, 3
P200100553	05211	2009, 5	P200200196	05122	2009, 1
P200100587	05208	2009, 4	P200200199	05168	2009, 3
P200100594	05193	2009, 4	P200200204	05175	2009, 3
P200200002	05188	2009, 4	P200200213	05230	2009, 6
P200200012	05147	2009, 2	P200200236	05154	2009, 2
P200200016	05140	2009, 1	P200200241	05210	2009, 5
P200200067	05238	2009, 6	P200200245	05191	2009, 4
P200200068	05239	2009, 6	P200200268	05162	2009, 2
P200200082	05248	2009, 6	P200200271	05127	2009, 1

Patenditaotluse number	Patendi number	Patendilehe number, kus avaldati patendi väljaandmise teade
------------------------	----------------	---

P200200280	05219	2009, 5	P200300204	05218	2009, 5
P200200326	05182	2009, 3	P200300225	05220	2009, 5
P200200330	05134	2009, 1	P200300241	05132	2009, 1
P200200341	05169	2009, 3	P200300255	05200	2009, 4
P200200343	05180	2009, 3	P200300282	05245	2009, 6
P200200344	05135	2009, 1	P200300300	05244	2009, 6
P200200349	05123	2009, 1	P200300307	05158	2009, 2
P200200368	05231	2009, 6	P200300331	05138	2009, 1
P200200396	05252	2009, 6	P200300337	05227	2009, 6
P200200397	05224	2009, 5	P200300340	05233	2009, 6
P200200403	05216	2009, 5	P200300369	05217	2009, 5
P200200411	05221	2009, 5	P200300389	05131	2009, 1
P200200417	05125	2009, 1	P200300402	05249	2009, 6
P200200420	05197	2009, 4	P200300417	05198	2009, 4
P200200437	05171	2009, 3	P200300433	05184	2009, 3
P200200438	05137	2009, 1	P200300434	05234	2009, 6
P200200459	05149	2009, 2	P200300442	05247	2009, 6
P200200474	05225	2009, 5	P200300457	05145	2009, 2
P200200535	05129	2009, 1	P200300545	05243	2009, 6
P200200630	05143	2009, 1	P200300558	05196	2009, 4
P200200635	05173	2009, 3	P200300562	05133	2009, 1
P200200649	05167	2009, 3	P200300573	05246	2009, 6
P200200655	05242	2009, 6	P200400027	05153	2009, 2
P200200665	05222	2009, 5	P200400049	05144	2009, 1
P200200666	05215	2009, 5	P200400063	05229	2009, 6
P200200669	05223	2009, 5	P200400079	05141	2009, 1
P200200704	05157	2009, 2	P200400081	05204	2009, 4
P200200718	05148	2009, 2	P200400095	05228	2009, 6
P200300035	05159	2009, 2	P200400112	05142	2009, 1
P200300036	05178	2009, 3	P200400114	05177	2009, 3
P200300046	05183	2009, 3	P200500008	05161	2009, 2
P200300087	05186	2009, 3	P200500036	05152	2009, 2
P200300090	05136	2009, 1	P200600020	05206	2009, 4
P200300114	05202	2009, 4	P200600040	05237	2009, 6
P200300126	05195	2009, 4	P200600042	05164	2009, 2
P200300129	05241	2009, 6	P200600043	05165	2009, 2
P200300135	05192	2009, 4	P200700005	05166	2009, 2
P200300139	05174	2009, 3	P200700011	05251	2009, 6
P200300151	05179	2009, 3	P200700017	05205	2009, 4
P200300170	05146	2009, 2	P200700034	05250	2009, 6
P200300180	05155	2009, 2	P200700044	05163	2009, 2
P200300182	05236	2009, 6	P200700045	05253	2009, 6
P200300183	05240	2009, 6	P200700057	05226	2009, 5
P200300198	05209	2009, 5	P200700058	05201	2009, 4

BB2A. AVALDATUD EUROOPA PATENDITAOTLUSTE PATENDINÕUDLUSE TÕLGETE NUMBRILINE LOEND

Patenditaotluse number	Patendinõudluse tõlke number	Patendilehe number, kus avaldati Euroopa patendinõudluse tõlke esitamise teade
------------------------	------------------------------	--

06252444.2	0027	2009, 1
05815688.6	0028	2009, 1
05801058.8	0029	2009, 1
07819726.6	0034	2009, 5
07025111.1	0035	2009, 5

FG4A. EESTIS KEHTIVATE EUROOPA PATENTIDE SÜSTEMAATILINE LOEND

Rahvusvahelise patendiklassifikatsiooni indeks	Registreeringu number	Patendikirjelduse tõlke number	Patendilehe number, kus avaldati Euroopa patendikirjelduse tõlke esitamise teade
A01B 3/28	E002812	EE-EP 1638385 B1	2009, 2
A01B 61/04	E003552	EE-EP 1856965 B1	2009, 6
A01C 1/04	E003553	EE-EP 1962572 B1	2009, 6
A01G 3/06	E003554	EE-EP 1486111 B1	2009, 6
A01G 9/10	E002813	EE-EP 1473984 B1	2009, 2
A01J 25/11	E003371	EE-EP 1642494 B1	2009, 5
A01N 25/02	E002592	EE-EP 1643833 B1	2009, 1
A01N 25/04	E002593	EE-EP 1482790 B1	2009, 1
A01N 25/18	E003206	EE-EP 1827096 B1	2009, 4
A01N 25/28	E003372	EE-EP 1531668 B1	2009, 5
A01N 35/04	E003013	EE-EP 1523238 B1	2009, 3
A01N 43/22	E002814	EE-EP 1435780 B1	2009, 2
A01N 43/40	E002815	EE-EP 1860941 B1	2009, 2
A01N 43/50	E002816	EE-EP 1734823 B1	2009, 2
A01N 43/54	E002594	EE-EP 1860945 B1	2009, 1
A01N 43/56	E002817	EE-EP 1705989 B1	2009, 2
A01N 43/56	E003014	EE-EP 1771070 B1	2009, 3
A01N 43/56	E003207	EE-EP 1778012 B1	2009, 4
A01N 43/64	E003015	EE-EP 1599096 B1	2009, 3
A01N 43/653	E002818	EE-EP 1484972 B1	2009, 2
A01N 43/653	E003208	EE-EP 1931203 B1	2009, 4
A01N 43/653	E003373	EE-EP 1651040 B1	2009, 5
A01N 43/653	E003374	EE-EP 1921918 B1	2009, 5
A01N 43/653	E003555	EE-EP 1677600 B1	2009, 6
A01N 47/24	E003375	EE-EP 1696728 B1	2009, 5
A01N 47/34	E002595	EE-EP 1413201 B1	2009, 1
A01N 53/00	E003376	EE-EP 1587368 B1	2009, 5
A01N 53/00	E003377	EE-EP 1624756 B1	2009, 5
A01N 57/20	E002596	EE-EP 1672982 B1	2009, 1
A01N 57/20	E003556	EE-EP 1509085 B1	2009, 6
A22B 3/00	E003016	EE-EP 1817961 B1	2009, 3
A22C 13/02	E002597	EE-EP 1796478 B1	2009, 1
A23B 7/00	E002598	EE-EP 1793684 B1	2009, 1
A23G 1/00	E003017	EE-EP 1921924 B1	2009, 3
A23G 1/20	E003557	EE-EP 1589823 B1	2009, 6
A23G 3/00	E002599	EE-EP 1759591 B1	2009, 1
A23G 3/00	E003378	EE-EP 1435204 B1	2009, 5
A23G 3/20	E003558	EE-EP 1868445 B1	2009, 6
A23J 1/14	E003379	EE-EP 1638408 B1	2009, 5
A23K 1/18	E002819	EE-EP 1675474 B1	2009, 2
A23L 1/00	E003209	EE-EP 1733628 B1	2009, 4
A23L 1/29	E002600	EE-EP 1685763 B1	2009, 1
A23L 1/29	E003380	EE-EP 1605780 B1	2009, 5
A23L 1/29	E003381	EE-EP 1815755 B1	2009, 5
A23L 1/30	E003210	EE-EP 1559430 B1	2009, 4
A23L 1/307	E002601	EE-EP 1729598 B1	2009, 1
A23L 1/317	E003018	EE-EP 1855551 B1	2009, 3
A23L 1/328	E003559	EE-EP 1959765 B1	2009, 6
A23L 2/00	E002602	EE-EP 1549159 B1	2009, 1
A23L 3/015	E003211	EE-EP 1841335 B1	2009, 4
A24B 15/16	E002603	EE-EP 1618803 B1	2009, 1
A24B 15/16	E003382	EE-EP 1736065 B1	2009, 5
A24D 1/00	E002820	EE-EP 1845809 B1	2009, 2
A24D 1/00	E003560	EE-EP 1427300 B1	2009, 6
A24D 3/06	E003383	EE-EP 1942753 B1	2009, 5

Rahvusvahelise patendiklassifikatsiooni indeks	Registreeringu number	Patendikirjelduse tõlke number	Patendilehe number, kus avaldati Euroopa patendikirjelduse tõlke esitamise teade
A24D 3/06	E003561	EE-EP 1906775 B1	2009, 6
A41B 11/00	E003019	EE-EP 1921935 B1	2009, 3
A41B 11/00	E003212	EE-EP 1585397 B1	2009, 4
A41B 11/00	E003213	EE-EP 1893044 B1	2009, 4
A41D 13/00	E003384	EE-EP 1476033 B1	2009, 5
A43B 7/12	E002604	EE-EP 1830673 B1	2009, 1
A43B 7/12	E002821	EE-EP 1605790 B1	2009, 2
A43B 9/18	E003214	EE-EP 1632142 B1	2009, 4
A43B 17/08	E003385	EE-EP 1500341 B1	2009, 5
A45F 3/04	E002605	EE-EP 1882426 B1	2009, 1
A45F 3/04	E003215	EE-EP 1744647 B1	2009, 4
A46B 9/06	E003386	EE-EP 1432329 B1	2009, 5
A47B 85/00	E002822	EE-EP 1416827 B1	2009, 2
A47C 19/00	E002823	EE-EP 1523256 B1	2009, 2
A47D 15/00	E003562	EE-EP 1991092 B1	2009, 6
A47F 5/05	E003020	EE-EP 1820425 B1	2009, 3
A47F 11/00	E002606	EE-EP 1759373 B1	2009, 1
A47H 13/04	E003021	EE-EP 1875838 B1	2009, 3
A47J 27/16	E003216	EE-EP 1631175 B1	2009, 4
A47J 27/21	E003022	EE-EP 1521540 B1	2009, 3
A47J 31/00	E002607	EE-EP 1761150 B1	2009, 1
A47J 31/00	E002824	EE-EP 1764014 B1	2009, 2
A47J 31/06	E003387	EE-EP 1967100 B1	2009, 5
A47J 31/30	E002608	EE-EP 1610657 B1	2009, 1
A47J 31/40	E003023	EE-EP 1816935 B1	2009, 3
A47J 31/40	E003024	EE-EP 1859712 B1	2009, 3
A47J 31/40	E003217	EE-EP 1859714 B1	2009, 4
A47J 31/40	E003388	EE-EP 1853142 B1	2009, 5
A47J 31/44	E003025	EE-EP 1827185 B1	2009, 3
A47J 31/54	E003563	EE-EP 1854386 B1	2009, 6
A47J 39/00	E002825	EE-EP 1686880 B1	2009, 2
A47J 43/07	E002826	EE-EP 1733665 B1	2009, 2
A47J 43/07	E002827	EE-EP 1747745 B1	2009, 2
A47K 4/00	E003389	EE-EP 1611827 B1	2009, 5
A61B 1/12	E002828	EE-EP 1646311 B1	2009, 2
A61B 5/022	E003026	EE-EP 1641389 B1	2009, 3
A61B 5/05	E003027	EE-EP 1503668 B1	2009, 3
A61B 5/15	E002609	EE-EP 1466558 B1	2009, 1
A61B 10/00	E003028	EE-EP 1791472 B1	2009, 3
A61B 17/072	E003029	EE-EP 1749486 B1	2009, 3
A61B 17/072	E003030	EE-EP 1774916 B1	2009, 3
A61B 17/70	E002829	EE-EP 1575433 B1	2009, 2
A61C 1/08	E003218	EE-EP 1404244 B1	2009, 4
A61C 8/00	E002830	EE-EP 1647239 B1	2009, 2
A61F 2/06	E002831	EE-EP 1550417 B1	2009, 2
A61F 2/06	E003031	EE-EP 1496815 B1	2009, 3
A61F 2/16	E002832	EE-EP 1743601 B1	2009, 2
A61F 2/16	E003032	EE-EP 1852090 B1	2009, 3
A61F 2/16	E003219	EE-EP 1610726 B1	2009, 4
A61F 2/16	E003220	EE-EP 1857077 B1	2009, 4
A61F 2/16	E003390	EE-EP 1891911 B1	2009, 5
A61F 2/88	E003564	EE-EP 1685813 B1	2009, 6
A61F 6/06	E003565	EE-EP 1605876 B1	2009, 6
A61F 9/007	E002610	EE-EP 1787606 B1	2009, 1
A61F 9/007	E003033	EE-EP 1917936 B1	2009, 3
A61J 1/05	E002611	EE-EP 1605891 B1	2009, 1
A61K 8/06	E003391	EE-EP 1973514 B1	2009, 5

Rahvusvahelise patendiklassifikatsiooni indeks	Registreeringu number	Patendikirjelduse tõlke number	Patendilehe number, kus avaldati Euroopa patendikirjelduse tõlke esitamise teade
A61K 8/14	E003392	EE-EP 1888013 B1	2009, 5
A61K 8/18	E002833	EE-EP 1689356 B1	2009, 2
A61K 8/18	E003221	EE-EP 1761236 B1	2009, 4
A61K 8/18	E003393	EE-EP 1673057 B1	2009, 5
A61K 8/31	E002612	EE-EP 1635776 B1	2009, 1
A61K 8/67	E002613	EE-EP 1594456 B1	2009, 1
A61K 9/00	E002614	EE-EP 1603532 B1	2009, 1
A61K 9/00	E002615	EE-EP 1906916 B1	2009, 1
A61K 9/00	E002834	EE-EP 1811957 B1	2009, 2
A61K 9/00	E002835	EE-EP 1792610 B1	2009, 2
A61K 9/00	E002836	EE-EP 1898876 B1	2009, 2
A61K 9/00	E003034	EE-EP 1521572 B1	2009, 3
A61K 9/00	E003035	EE-EP 1534237 B1	2009, 3
A61K 9/00	E003036	EE-EP 1660034 B1	2009, 3
A61K 9/00	E003222	EE-EP 1748756 B1	2009, 4
A61K 9/00	E003223	EE-EP 1885336 B1	2009, 4
A61K 9/00	E003394	EE-EP 1711158 B1	2009, 5
A61K 9/06	E003037	EE-EP 1758555 B1	2009, 3
A61K 9/08	E002616	EE-EP 1543826 B1	2009, 1
A61K 9/08	E003224	EE-EP 1948131 B1	2009, 4
A61K 9/08	E003395	EE-EP 1889607 B1	2009, 5
A61K 9/10	E002837	EE-EP 1513500 B1	2009, 2
A61K 9/107	E003038	EE-EP 1906921 B1	2009, 3
A61K 9/113	E003396	EE-EP 1843749 B1	2009, 5
A61K 9/12	E003397	EE-EP 1420759 B1	2009, 5
A61K 9/127	E002617	EE-EP 1765289 B1	2009, 1
A61K 9/14	E003039	EE-EP 1729730 B1	2009, 3
A61K 9/14	E003398	EE-EP 1578350 B1	2009, 5
A61K 9/16	E002618	EE-EP 1537859 B1	2009, 1
A61K 9/16	E002838	EE-EP 1492506 B1	2009, 2
A61K 9/16	E002839	EE-EP 1680088 B1	2009, 2
A61K 9/16	E003225	EE-EP 1718258 B1	2009, 4
A61K 9/16	E003226	EE-EP 1729732 B1	2009, 4
A61K 9/16	E003399	EE-EP 1551763 B1	2009, 5
A61K 9/16	E003400	EE-EP 1861073 B1	2009, 5
A61K 9/16	E003401	EE-EP 1965768 B1	2009, 5
A61K 9/16	E003566	EE-EP 1465602 B1	2009, 6
A61K 9/16	E003567	EE-EP 1987817 B1	2009, 6
A61K 9/19	E002619	EE-EP 1675573 B1	2009, 1
A61K 9/20	E002620	EE-EP 1819320 B1	2009, 1
A61K 9/20	E002840	EE-EP 1515702 B1	2009, 2
A61K 9/20	E002841	EE-EP 1613288 B1	2009, 2
A61K 9/20	E002842	EE-EP 1635830 B1	2009, 2
A61K 9/20	E003040	EE-EP 1937221 B1	2009, 3
A61K 9/20	E003402	EE-EP 1556013 B1	2009, 5
A61K 9/20	E003403	EE-EP 1740154 B1	2009, 5
A61K 9/24	E003041	EE-EP 1890681 B1	2009, 3
A61K 9/28	E002621	EE-EP 1455761 B1	2009, 1
A61K 9/48	E002622	EE-EP 1838293 B1	2009, 1
A61K 9/48	E002843	EE-EP 1608346 B1	2009, 2
A61K 9/48	E003227	EE-EP 1940366 B1	2009, 4
A61K 9/50	E002844	EE-EP 1667665 B1	2009, 2
A61K 9/50	E003042	EE-EP 1928431 B1	2009, 3
A61K 9/50	E003228	EE-EP 1515704 B1	2009, 4
A61K 9/50	E003229	EE-EP 1667666 B1	2009, 4
A61K 9/51	E003404	EE-EP 1638539 B1	2009, 5
A61K 9/70	E002845	EE-EP 1615628 B1	2009, 2

Rahvusvahelise patendiklassifikatsiooni indeks	Registreeringu number	Patendikirjelduse tõlke number	Patendilehe number, kus avaldati Euroopa patendikirjelduse tõlke esitamise teade
A61K 9/72	E003043	EE-EP 1474117 B1	2009, 3
A61K 31/00	E002846	EE-EP 1663185 B1	2009, 2
A61K 31/00	E003230	EE-EP 1511472 B1	2009, 4
A61K 31/00	E003231	EE-EP 1556020 B1	2009, 4
A61K 31/00	E003232	EE-EP 1809267 B1	2009, 4
A61K 31/00	E003405	EE-EP 1758565 B1	2009, 5
A61K 31/00	E003406	EE-EP 1808168 B1	2009, 5
A61K 31/00	E003568	EE-EP 1729753 B1	2009, 6
A61K 31/047	E003407	EE-EP 1608350 B1	2009, 5
A61K 31/133	E003044	EE-EP 1425001 B1	2009, 3
A61K 31/135	E002847	EE-EP 1505959 B1	2009, 2
A61K 31/137	E002623	EE-EP 1708679 B1	2009, 1
A61K 31/138	E002848	EE-EP 1799201 B1	2009, 2
A61K 31/138	E002849	EE-EP 1666033 B1	2009, 2
A61K 31/14	E002624	EE-EP 1646373 B1	2009, 1
A61K 31/16	E003408	EE-EP 1613296 B1	2009, 5
A61K 31/165	E003409	EE-EP 1556026 B1	2009, 5
A61K 31/166	E003569	EE-EP 1414428 B1	2009, 6
A61K 31/167	E002850	EE-EP 1768657 B1	2009, 2
A61K 31/18	E002625	EE-EP 1677779 B1	2009, 1
A61K 31/19	E002626	EE-EP 1635808 B1	2009, 1
A61K 31/19	E002851	EE-EP 1423105 B1	2009, 2
A61K 31/19	E003233	EE-EP 1572180 B1	2009, 4
A61K 31/192	E002627	EE-EP 1532974 B1	2009, 1
A61K 31/192	E002852	EE-EP 1613300 B1	2009, 2
A61K 31/192	E003410	EE-EP 1485080 B1	2009, 5
A61K 31/195	E002628	EE-EP 1720538 B1	2009, 1
A61K 31/198	E003045	EE-EP 1754478 B1	2009, 3
A61K 31/20	E003046	EE-EP 1592416 B1	2009, 3
A61K 31/205	E002853	EE-EP 1824472 B1	2009, 2
A61K 31/21	E003047	EE-EP 1569635 B1	2009, 3
A61K 31/225	E002629	EE-EP 1411916 B1	2009, 1
A61K 31/23	E003048	EE-EP 1448186 B1	2009, 3
A61K 31/27	E003411	EE-EP 1408954 B1	2009, 5
A61K 31/343	E003234	EE-EP 1541197 B1	2009, 4
A61K 31/352	E003570	EE-EP 1797876 B1	2009, 6
A61K 31/366	E002630	EE-EP 1740164 B1	2009, 1
A61K 31/375	E002854	EE-EP 1646378 B1	2009, 2
A61K 31/381	E002855	EE-EP 1863474 B1	2009, 2
A61K 31/397	E002631	EE-EP 1427409 B1	2009, 1
A61K 31/40	E003235	EE-EP 1513519 B1	2009, 4
A61K 31/4015	E003049	EE-EP 1807072 B1	2009, 3
A61K 31/4035	E003571	EE-EP 1485087 B1	2009, 6
A61K 31/404	E002856	EE-EP 1703905 B1	2009, 2
A61K 31/404	E003236	EE-EP 1835907 B1	2009, 4
A61K 31/404	E003572	EE-EP 1682121 B1	2009, 6
A61K 31/405	E002632	EE-EP 1515717 B1	2009, 1
A61K 31/405	E003412	EE-EP 1667678 B1	2009, 5
A61K 31/4184	E003413	EE-EP 1507529 B1	2009, 5
A61K 31/4184	E003573	EE-EP 1835912 B1	2009, 6
A61K 31/4184	E003574	EE-EP 1877052 B1	2009, 6
A61K 31/4196	E002633	EE-EP 1713477 B1	2009, 1
A61K 31/423	E002634	EE-EP 1827427 B1	2009, 1
A61K 31/423	E002857	EE-EP 1824479 B1	2009, 2
A61K 31/425	E003575	EE-EP 1503756 B1	2009, 6
A61K 31/427	E003237	EE-EP 1689391 B1	2009, 4
A61K 31/4365	E003576	EE-EP 1896019 B1	2009, 6

Rahvusvahelise patendiklassifikatsiooni indeks	Registreeringu number	Patendikirjelduse tõlke number	Patendilehe number, kus avaldati Euroopa patendikirjelduse tõlke esitamise teade
A61K 31/437	E003577	EE-EP 1919474 B1	2009, 6
A61K 31/4375	E003238	EE-EP 1696913 B1	2009, 4
A61K 31/44	E002635	EE-EP 1796668 B1	2009, 1
A61K 31/44	E002636	EE-EP 1465626 B1	2009, 1
A61K 31/44	E003414	EE-EP 1414451 B1	2009, 5
A61K 31/4418	E003239	EE-EP 1455785 B1	2009, 4
A61K 31/444	E003578	EE-EP 1750704 B1	2009, 6
A61K 31/445	E003240	EE-EP 1530469 B1	2009, 4
A61K 31/445	E003415	EE-EP 1513528 B1	2009, 5
A61K 31/445	E003416	EE-EP 1680105 B1	2009, 5
A61K 31/4468	E002858	EE-EP 1708705 B1	2009, 2
A61K 31/4468	E003241	EE-EP 1720550 B1	2009, 4
A61K 31/451	E002637	EE-EP 1626720 B1	2009, 1
A61K 31/454	E003417	EE-EP 1423115 B1	2009, 5
A61K 31/454	E003418	EE-EP 1691808 B1	2009, 5
A61K 31/454	E003579	EE-EP 2007384 B1	2009, 6
A61K 31/455	E003419	EE-EP 1624871 B1	2009, 5
A61K 31/465	E003050	EE-EP 1458388 B1	2009, 3
A61K 31/47	E002638	EE-EP 1458390 B1	2009, 1
A61K 31/47	E002639	EE-EP 1879581 B1	2009, 1
A61K 31/47	E002640	EE-EP 1881830 B1	2009, 1
A61K 31/47	E003242	EE-EP 1879580 B1	2009, 4
A61K 31/473	E003051	EE-EP 1885363 B1	2009, 3
A61K 31/473	E003052	EE-EP 1855677 B1	2009, 3
A61K 31/473	E003243	EE-EP 1861100 B1	2009, 4
A61K 31/4745	E003053	EE-EP 1719511 B1	2009, 3
A61K 31/4747	E002641	EE-EP 1601359 B1	2009, 1
A61K 31/485	E002859	EE-EP 1539166 B1	2009, 2
A61K 31/496	E003244	EE-EP 1542668 B1	2009, 4
A61K 31/496	E003245	EE-EP 1703909 B1	2009, 4
A61K 31/4965	E003054	EE-EP 1608374 B1	2009, 3
A61K 31/497	E003055	EE-EP 1663236 B1	2009, 3
A61K 31/498	E002642	EE-EP 1689404 B1	2009, 1
A61K 31/502	E003246	EE-EP 1686997 B1	2009, 4
A61K 31/506	E002860	EE-EP 1531819 B1	2009, 2
A61K 31/506	E003420	EE-EP 1686999 B1	2009, 5
A61K 31/513	E002861	EE-EP 1646389 B1	2009, 2
A61K 31/513	E003056	EE-EP 1663243 B1	2009, 3
A61K 31/517	E002643	EE-EP 1653964 B1	2009, 1
A61K 31/517	E003580	EE-EP 1753431 B1	2009, 6
A61K 31/519	E002862	EE-EP 1750716 B1	2009, 2
A61K 31/519	E003421	EE-EP 1888077 B1	2009, 5
A61K 31/52	E003057	EE-EP 1845994 B1	2009, 3
A61K 31/53	E003247	EE-EP 1524981 B1	2009, 4
A61K 31/5375	E002644	EE-EP 1769798 B1	2009, 1
A61K 31/5377	E002863	EE-EP 1553952 B1	2009, 2
A61K 31/538	E003422	EE-EP 1562603 B1	2009, 5
A61K 31/5415	E002864	EE-EP 1478366 B1	2009, 2
A61K 31/55	E002645	EE-EP 1596868 B1	2009, 1
A61K 31/55	E002646	EE-EP 1706121 B1	2009, 1
A61K 31/55	E002865	EE-EP 1509232 B1	2009, 2
A61K 31/55	E003248	EE-EP 1729777 B1	2009, 4
A61K 31/55	E003423	EE-EP 1519731 B1	2009, 5
A61K 31/55	E003581	EE-EP 1861105 B1	2009, 6
A61K 31/551	E002866	EE-EP 1818059 B1	2009, 2
A61K 31/551	E003249	EE-EP 1696931 B1	2009, 4
A61K 31/5513	E003582	EE-EP 1727550 B1	2009, 6

Rahvusvahelise patendiklassifikatsiooni indeks	Registreeringu number	Patendikirjelduse tõlke number	Patendilehe number, kus avaldati Euroopa patendikirjelduse tõlke esitamise teade
A61K 31/553	E003583	EE-EP 1771178 B1	2009, 6
A61K 31/5575	E002867	EE-EP 1474143 B1	2009, 2
A61K 31/5575	E003250	EE-EP 1759702 B1	2009, 4
A61K 31/56	E002647	EE-EP 1408981 B1	2009, 1
A61K 31/56	E003424	EE-EP 1416937 B1	2009, 5
A61K 31/565	E002648	EE-EP 1462107 B1	2009, 1
A61K 31/565	E003058	EE-EP 1787649 B1	2009, 3
A61K 31/569	E003059	EE-EP 1635843 B1	2009, 3
A61K 31/57	E002868	EE-EP 1575597 B1	2009, 2
A61K 31/58	E003060	EE-EP 1652526 B1	2009, 3
A61K 31/66	E002869	EE-EP 1742642 B1	2009, 2
A61K 31/70	E003425	EE-EP 1721612 B1	2009, 5
A61K 31/7016	E003061	EE-EP 1663257 B1	2009, 3
A61K 31/702	E003584	EE-EP 1684770 B1	2009, 6
A61K 31/7076	E003426	EE-EP 1581235 B1	2009, 5
A61K 31/7076	E003427	EE-EP 1835922 B1	2009, 5
A61K 31/7125	E003062	EE-EP 1877070 B1	2009, 3
A61K 31/715	E002870	EE-EP 1455802 B1	2009, 2
A61K 31/715	E003251	EE-EP 1638582 B1	2009, 4
A61K 31/728	E002871	EE-EP 1677806 B1	2009, 2
A61K 35/20	E003252	EE-EP 1568356 B1	2009, 4
A61K 35/22	E003253	EE-EP 1553959 B1	2009, 4
A61K 36/00	E003063	EE-EP 1658854 B1	2009, 3
A61K 36/00	E003254	EE-EP 1841439 B1	2009, 4
A61K 36/185	E003585	EE-EP 1978981 B1	2009, 6
A61K 36/28	E003255	EE-EP 1967198 B1	2009, 4
A61K 36/68	E003064	EE-EP 1829548 B1	2009, 3
A61K 36/74	E003586	EE-EP 1620116 B1	2009, 6
A61K 36/76	E002649	EE-EP 1648484 B1	2009, 1
A61K 36/8962	E002650	EE-EP 1566179 B1	2009, 1
A61K 38/00	E003065	EE-EP 1776958 B1	2009, 3
A61K 38/06	E002651	EE-EP 1755634 B1	2009, 1
A61K 38/13	E003587	EE-EP 1663287 B1	2009, 6
A61K 38/16	E003066	EE-EP 1429800 B1	2009, 3
A61K 38/17	E003256	EE-EP 1824504 B1	2009, 4
A61K 38/17	E003588	EE-EP 1623719 B1	2009, 6
A61K 38/18	E003067	EE-EP 1386615 B1	2009, 3
A61K 38/18	E003257	EE-EP 1466617 B1	2009, 4
A61K 38/19	E002652	EE-EP 1651247 B1	2009, 1
A61K 38/20	E003258	EE-EP 1793859 B1	2009, 4
A61K 38/24	E003068	EE-EP 1434600 B1	2009, 3
A61K 38/48	E003259	EE-EP 1536827 B1	2009, 4
A61K 38/50	E003428	EE-EP 1874341 B1	2009, 5
A61K 38/57	E003069	EE-EP 1599222 B1	2009, 3
A61K 39/012	E002653	EE-EP 1476558 B1	2009, 1
A61K 39/10	E002872	EE-EP 1411978 B1	2009, 2
A61K 39/12	E003429	EE-EP 1673106 B1	2009, 5
A61K 39/39	E002873	EE-EP 1696954 B1	2009, 2
A61K 39/39	E003260	EE-EP 1904099 B1	2009, 4
A61K 39/395	E002654	EE-EP 1585546 B1	2009, 1
A61K 39/395	E002655	EE-EP 1631312 B1	2009, 1
A61K 39/395	E003261	EE-EP 1414494 B1	2009, 4
A61K 39/395	E003262	EE-EP 1613350 B1	2009, 4
A61K 39/395	E003263	EE-EP 1737488 B1	2009, 4
A61K 45/00	E002656	EE-EP 1459765 B1	2009, 1
A61K 45/00	E002874	EE-EP 1763369 B1	2009, 2
A61K 45/00	E003070	EE-EP 1765404 B1	2009, 3

Rahvusvahelise patendiklassifikatsiooni indeks	Registreeringu number	Patendikirjelduse tõlke number	Patendilehe number, kus avaldati Euroopa patendikirjelduse tõlke esitamise teade
A61K 45/00	E003264	EE-EP 1763368 B1	2009, 4
A61K 47/00	E002657	EE-EP 1448234 B1	2009, 1
A61K 47/00	E003589	EE-EP 1715893 B1	2009, 6
A61K 47/10	E002875	EE-EP 1511516 B1	2009, 2
A61K 47/24	E003590	EE-EP 1802347 B1	2009, 6
A61K 47/34	E002658	EE-EP 1635875 B1	2009, 1
A61K 47/36	E003071	EE-EP 1682185 B1	2009, 3
A61K 47/48	E003265	EE-EP 1786400 B1	2009, 4
A61K 47/48	E003430	EE-EP 1827500 B1	2009, 5
A61K 48/00	E002876	EE-EP 1446162 B1	2009, 2
A61K 48/00	E003266	EE-EP 1515752 B1	2009, 4
A61K 51/12	E002659	EE-EP 1744789 B1	2009, 1
A61L 2/00	E003267	EE-EP 1476201 B1	2009, 4
A61L 2/025	E003431	EE-EP 1862185 B1	2009, 5
A61L 15/42	E002660	EE-EP 1833518 B1	2009, 1
A61L 24/02	E003072	EE-EP 1782845 B1	2009, 3
A61L 24/06	E002661	EE-EP 1648531 B1	2009, 1
A61L 27/02	E003591	EE-EP 1671661 B1	2009, 6
A61L 27/18	E002662	EE-EP 1534352 B1	2009, 1
A61L 27/30	E002663	EE-EP 1626749 B1	2009, 1
A61L 27/38	E002877	EE-EP 1610834 B1	2009, 2
A61L 27/50	E003592	EE-EP 1745806 B1	2009, 6
A61L 31/10	E003432	EE-EP 1542740 B1	2009, 5
A61M 1/00	E002878	EE-EP 1810702 B1	2009, 2
A61M 1/00	E002879	EE-EP 1867349 B1	2009, 2
A61M 1/00	E003268	EE-EP 1897569 B1	2009, 4
A61M 1/00	E003269	EE-EP 1894583 B1	2009, 4
A61M 1/00	E003593	EE-EP 1839689 B1	2009, 6
A61M 5/20	E002880	EE-EP 1467785 B1	2009, 2
A61M 5/24	E003270	EE-EP 1885413 B1	2009, 4
A61M 5/24	E003594	EE-EP 1527795 B1	2009, 6
A61M 5/30	E003271	EE-EP 1409045 B1	2009, 4
A61M 5/31	E002881	EE-EP 1773431 B1	2009, 2
A61M 5/315	E002664	EE-EP 1799286 B1	2009, 1
A61M 5/315	E002665	EE-EP 1601397 B1	2009, 1
A61M 5/315	E002666	EE-EP 1603610 B1	2009, 1
A61M 5/315	E003073	EE-EP 1559443 B1	2009, 3
A61M 5/315	E003074	EE-EP 1920794 B1	2009, 3
A61M 5/315	E003595	EE-EP 1913967 B1	2009, 6
A61M 5/32	E003433	EE-EP 1569708 B1	2009, 5
A61M 11/00	E003596	EE-EP 1509266 B1	2009, 6
A61M 15/00	E002667	EE-EP 1768728 B1	2009, 1
A61M 15/00	E003597	EE-EP 1633422 B1	2009, 6
A61M 35/00	E002668	EE-EP 1726327 B1	2009, 1
A61M 39/02	E003272	EE-EP 1736194 B1	2009, 4
A61N 5/06	E002669	EE-EP 1534388 B1	2009, 1
A61P 9/10	E002670	EE-EP 1487541 B1	2009, 1
A61P 9/10	E003075	EE-EP 1832287 B1	2009, 3
A61P 17/14	E002671	EE-EP 1569724 B1	2009, 1
A61P 25/30	E003076	EE-EP 1416842 B1	2009, 3
A61P 27/02	E003077	EE-EP 1463563 B1	2009, 3
A61P 35/00	E003273	EE-EP 1545710 B1	2009, 4
A62C 2/00	E003078	EE-EP 1913979 B1	2009, 3
A62C 2/00	E003434	EE-EP 1913978 B1	2009, 5
A62C 2/00	E003598	EE-EP 1838396 B1	2009, 6
A62C 39/00	E002882	EE-EP 1911498 B1	2009, 2
A62C 39/00	E003079	EE-EP 1476226 B1	2009, 3

Rahvusvahelise patendiklassifikatsiooni indeks	Registreeringu number	Patendikirjelduse tõlke number	Patendilehe number, kus avaldati Euroopa patendikirjelduse tõlke esitamise teade
A62C 39/00	E003080	EE-EP 1913980 B1	2009, 3
A62C 39/00	E003435	EE-EP 1941932 B1	2009, 5
A63F 13/00	E003436	EE-EP 1786531 B1	2009, 5
B01D 9/00	E003437	EE-EP 1499410 B1	2009, 5
B01D 9/02	E003438	EE-EP 1965879 B1	2009, 5
B01D 11/04	E002883	EE-EP 1572315 B1	2009, 2
B01D 21/02	E002672	EE-EP 1463575 B1	2009, 1
B01D 53/50	E003274	EE-EP 1629880 B1	2009, 4
B01D 53/62	E002884	EE-EP 1699545 B1	2009, 2
B01D 69/10	E003081	EE-EP 1807184 B1	2009, 3
B01F 15/02	E003439	EE-EP 1945339 B1	2009, 5
B01J 8/06	E003440	EE-EP 1877173 B1	2009, 5
B01J 14/00	E002673	EE-EP 1412078 B1	2009, 1
B01J 19/00	E003599	EE-EP 1967262 B1	2009, 6
B01L 3/14	E003275	EE-EP 1530506 B1	2009, 4
B02C 13/20	E003276	EE-EP 1554044 B1	2009, 4
B02C 19/06	E003441	EE-EP 1572367 B1	2009, 5
B05B 7/08	E003600	EE-EP 1663505 B1	2009, 6
B05B 7/24	E003082	EE-EP 1658143 B1	2009, 3
B05D 3/02	E003277	EE-EP 1810755 B1	2009, 4
B05D 3/14	E003278	EE-EP 1937415 B1	2009, 4
B07B 9/00	E002674	EE-EP 1490182 B1	2009, 1
B07C 5/12	E003601	EE-EP 1812176 B1	2009, 6
B09B 3/00	E003279	EE-EP 1968756 B1	2009, 4
B09B 3/00	E003442	EE-EP 1277527 B1	2009, 5
B09C 1/02	E003280	EE-EP 1404466 B1	2009, 4
B09C 1/08	E003443	EE-EP 1596998 B1	2009, 5
B21B 1/46	E002675	EE-EP 1868748 B1	2009, 1
B21D 5/08	E003444	EE-EP 1964621 B1	2009, 5
B21D 13/04	E003281	EE-EP 1772206 B1	2009, 4
B21D 39/03	E003445	EE-EP 1911534 B1	2009, 5
B21D 39/06	E003446	EE-EP 1727632 B1	2009, 5
B21D 53/88	E002885	EE-EP 1350580 B1	2009, 2
B21F 27/10	E002886	EE-EP 1837097 B1	2009, 2
B21K 7/02	E002676	EE-EP 1490190 B1	2009, 1
B22C 1/22	E003282	EE-EP 1753560 B1	2009, 4
B22F 9/20	E003283	EE-EP 1761353 B1	2009, 4
B22F 9/22	E003447	EE-EP 1753566 B1	2009, 5
B22F 9/24	E003602	EE-EP 1827739 B1	2009, 6
B23K 20/12	E003448	EE-EP 1459833 B1	2009, 5
B23P 15/26	E003603	EE-EP 1648654 B1	2009, 6
B24B 7/06	E002677	EE-EP 1477275 B1	2009, 1
B24B 31/00	E003449	EE-EP 1646477 B1	2009, 5
B24D 15/10	E003604	EE-EP 1877226 B1	2009, 6
B26B 21/52	E002887	EE-EP 1722945 B1	2009, 2
B26D 1/30	E003450	EE-EP 1855848 B1	2009, 5
B27B 33/08	E002888	EE-EP 1872918 B1	2009, 2
B27D 1/00	E002678	EE-EP 1761370 B1	2009, 1
B27K 3/15	E003284	EE-EP 1526954 B1	2009, 4
B27L 11/00	E003451	EE-EP 1485238 B1	2009, 5
B27M 3/04	E003083	EE-EP 1719596 B1	2009, 3
B27M 3/18	E002889	EE-EP 1858679 B1	2009, 2
B28B 1/26	E003605	EE-EP 1699609 B1	2009, 6
B29B 9/06	E002890	EE-EP 1851023 B1	2009, 2
B29C 45/14	E002679	EE-EP 1438172 B1	2009, 1
B29C 57/02	E003084	EE-EP 1792704 B1	2009, 3
B29C 65/00	E002891	EE-EP 1940603 B1	2009, 2

Rahvusvahelise patendiklassifikatsiooni indeks	Registreeringu number	Patendikirjelduse tõlke number	Patendilehe number, kus avaldati Euroopa patendikirjelduse tõlke esitamise teade
B29C 65/00	E003452	EE-EP 1968779 B1	2009, 5
B29C 65/34	E003606	EE-EP 1793978 B1	2009, 6
B29C 70/50	E003085	EE-EP 1727665 B1	2009, 3
B31B 1/16	E002680	EE-EP 1864791 B1	2009, 1
B31F 1/07	E003285	EE-EP 1991411 B1	2009, 4
B32B 27/08	E003607	EE-EP 1449645 B1	2009, 6
B41F 5/24	E003286	EE-EP 1480819 B1	2009, 4
B41J 2/175	E003086	EE-EP 1834789 B1	2009, 3
B41M 5/00	E003608	EE-EP 1872959 B1	2009, 6
B42C 7/00	E003609	EE-EP 1371502 B1	2009, 6
B42D 3/00	E002892	EE-EP 1637344 B1	2009, 2
B42D 15/00	E003087	EE-EP 1765600 B1	2009, 3
B42D 15/00	E003088	EE-EP 1492678 B1	2009, 3
B42D 15/10	E002681	EE-EP 1846253 B1	2009, 1
B44C 1/22	E003610	EE-EP 1555141 B1	2009, 6
B44D 3/12	E003611	EE-EP 1827873 B1	2009, 6
B60C 11/16	E003612	EE-EP 1798068 B1	2009, 6
B60K 7/00	E002682	EE-EP 1506888 B1	2009, 1
B60P 1/28	E003287	EE-EP 1794028 B1	2009, 4
B61G 5/10	E003089	EE-EP 1710145 B1	2009, 3
B61G 7/00	E003453	EE-EP 1626886 B1	2009, 5
B61L 23/04	E002683	EE-EP 1348609 B1	2009, 1
B62B 3/06	E003090	EE-EP 1340667 B1	2009, 3
B62D 25/18	E003613	EE-EP 1740440 B1	2009, 6
B62D 55/075	E003454	EE-EP 1798139 B1	2009, 5
B63B 1/38	E003455	EE-EP 1487692 B1	2009, 5
B63B 25/24	E003091	EE-EP 1478567 B1	2009, 3
B63B 39/00	E002893	EE-EP 1695902 B1	2009, 2
B63B 39/06	E003288	EE-EP 1472133 B1	2009, 4
B63G 8/08	E003289	EE-EP 1937546 B1	2009, 4
B63H 20/06	E003456	EE-EP 1792826 B1	2009, 5
B63H 25/38	E003290	EE-EP 1626897 B1	2009, 4
B64C 39/00	E002684	EE-EP 1575828 B1	2009, 1
B65B 1/36	E003457	EE-EP 1698553 B1	2009, 5
B65B 5/02	E003458	EE-EP 1954566 B1	2009, 5
B65B 61/20	E002685	EE-EP 1502859 B1	2009, 1
B65D 1/02	E003459	EE-EP 1687209 B1	2009, 5
B65D 1/16	E002894	EE-EP 1621468 B1	2009, 2
B65D 13/00	E003460	EE-EP 1757527 B1	2009, 5
B65D 19/40	E002686	EE-EP 1863718 B1	2009, 1
B65D 19/44	E003291	EE-EP 1888415 B1	2009, 4
B65D 33/34	E003292	EE-EP 1778553 B1	2009, 4
B65D 33/34	E003614	EE-EP 1714895 B1	2009, 6
B65D 41/34	E003615	EE-EP 1786694 B1	2009, 6
B65D 43/10	E002895	EE-EP 1724202 B1	2009, 2
B65D 43/10	E003092	EE-EP 1414708 B1	2009, 3
B65D 43/16	E003461	EE-EP 1533244 B1	2009, 5
B65D 47/10	E002687	EE-EP 1702859 B1	2009, 1
B65D 47/18	E003462	EE-EP 1601582 B1	2009, 5
B65D 47/20	E002688	EE-EP 1620323 B1	2009, 1
B65D 71/00	E003616	EE-EP 1740484 B1	2009, 6
B65D 73/00	E003463	EE-EP 1478579 B1	2009, 5
B65D 75/58	E003093	EE-EP 1939106 B1	2009, 3
B65D 75/58	E003293	EE-EP 1917198 B1	2009, 4
B65D 77/22	E003094	EE-EP 1714908 B1	2009, 3
B65D 81/00	E003464	EE-EP 1784344 B1	2009, 5
B65D 83/14	E002896	EE-EP 1753674 B1	2009, 2

Rahvusvahelise patendiklassifikatsiooni indeks	Registreeringu number	Patendikirjelduse tõlke number	Patendilehe number, kus avaldati Euroopa patendikirjelduse tõlke esitamise teade
B65D 83/14	E003617	EE-EP 1915301 B1	2009, 6
B65D 85/10	E003095	EE-EP 1910190 B1	2009, 3
B65D 85/10	E003294	EE-EP 1669306 B1	2009, 4
B65D 85/804	E002689	EE-EP 1864917 B1	2009, 1
B65D 88/06	E003465	EE-EP 1533252 B1	2009, 5
B65D 88/70	E002897	EE-EP 1364890 B1	2009, 2
B65D 90/12	E003466	EE-EP 1736421 B1	2009, 5
B65G 15/08	E003618	EE-EP 1948537 B1	2009, 6
B65G 23/44	E002690	EE-EP 1923336 B1	2009, 1
B65G 47/84	E002691	EE-EP 1789351 B1	2009, 1
B65G 67/20	E002898	EE-EP 1742858 B1	2009, 2
B65H 18/28	E003096	EE-EP 1636123 B1	2009, 3
B65H 18/28	E003097	EE-EP 1893513 B1	2009, 3
B65H 75/14	E002692	EE-EP 1795479 B1	2009, 1
B66B 11/00	E003619	EE-EP 1558513 B1	2009, 6
B66F 3/02	E002899	EE-EP 1848655 B1	2009, 2
B68G 1/00	E002900	EE-EP 1549585 B1	2009, 2
C01B 3/26	E002693	EE-EP 1694599 B1	2009, 1
C01G 1/02	E003295	EE-EP 1663870 B1	2009, 4
C01G 23/053	E003296	EE-EP 1904404 B1	2009, 4
C01G 33/00	E003098	EE-EP 1890967 B1	2009, 3
C02F 1/28	E003297	EE-EP 2011766 B1	2009, 4
C02F 1/465	E002901	EE-EP 1583719 B1	2009, 2
C02F 1/48	E003620	EE-EP 1636139 B1	2009, 6
C02F 1/62	E003467	EE-EP 1764348 B1	2009, 5
C02F 3/10	E002902	EE-EP 1430000 B1	2009, 2
C02F 3/28	E003468	EE-EP 1712526 B1	2009, 5
C02F 9/02	E003099	EE-EP 1584606 B1	2009, 3
C03C 23/00	E002694	EE-EP 1877351 B1	2009, 1
C04B 11/028	E003469	EE-EP 1485329 B1	2009, 5
C04B 24/40	E003470	EE-EP 1871722 B1	2009, 5
C05F 1/00	E003100	EE-EP 1517873 B1	2009, 3
C07B 31/00	E003298	EE-EP 1631533 B1	2009, 4
C07B 57/00	E002903	EE-EP 1797021 B1	2009, 2
C07C 1/32	E003101	EE-EP 1490312 B1	2009, 3
C07C 2/40	E003471	EE-EP 1678103 B1	2009, 5
C07C 33/02	E003621	EE-EP 1501774 B1	2009, 6
C07C 57/60	E002695	EE-EP 1594833 B1	2009, 1
C07C 59/68	E003299	EE-EP 1805129 B1	2009, 4
C07C 59/68	E003472	EE-EP 1849762 B1	2009, 5
C07C 59/90	E003102	EE-EP 1565422 B1	2009, 3
C07C 65/28	E003300	EE-EP 1472209 B1	2009, 4
C07C 65/40	E003301	EE-EP 1836151 B1	2009, 4
C07C 69/00	E002696	EE-EP 1567474 B1	2009, 1
C07C 69/00	E003622	EE-EP 1840125 B1	2009, 6
C07C 69/612	E002697	EE-EP 1581474 B1	2009, 1
C07C 69/74	E003103	EE-EP 1966118 B1	2009, 3
C07C 201/08	E003473	EE-EP 1814840 B1	2009, 5
C07C 205/38	E003302	EE-EP 1660431 B1	2009, 4
C07C 209/46	E003623	EE-EP 1940772 B1	2009, 6
C07C 209/74	E003104	EE-EP 1558560 B1	2009, 3
C07C 211/27	E002904	EE-EP 1461306 B1	2009, 2
C07C 215/44	E003624	EE-EP 1406858 B1	2009, 6
C07C 215/64	E003474	EE-EP 1881956 B1	2009, 5
C07C 217/62	E003303	EE-EP 1633697 B1	2009, 4
C07C 229/08	E003625	EE-EP 1492761 B1	2009, 6
C07C 229/60	E003304	EE-EP 1446379 B1	2009, 4

Rahvusvahelise patendiklassifikatsiooni indeks	Registreeringu number	Patendikirjelduse tõlke number	Patendilehe number, kus avaldati Euroopa patendikirjelduse tõlke esitamise teade
C07C 233/05	E003626	EE-EP 1558565 B1	2009, 6
C07C 233/18	E002698	EE-EP 1564202 B1	2009, 1
C07C 233/25	E003475	EE-EP 1511718 B1	2009, 5
C07C 233/43	E003305	EE-EP 1687257 B1	2009, 4
C07C 233/63	E003627	EE-EP 1871738 B1	2009, 6
C07C 235/78	E003105	EE-EP 1856031 B1	2009, 3
C07C 237/04	E003306	EE-EP 1465861 B1	2009, 4
C07C 253/34	E002699	EE-EP 1716108 B1	2009, 1
C07C 255/29	E003106	EE-EP 1682493 B1	2009, 3
C07C 259/10	E003628	EE-EP 1611088 B1	2009, 6
C07C 259/14	E002905	EE-EP 1856035 B1	2009, 2
C07C 303/40	E003307	EE-EP 1603866 B1	2009, 4
C07C 311/08	E003476	EE-EP 1519915 B1	2009, 5
C07C 315/02	E002700	EE-EP 1506171 B1	2009, 1
C07C 315/02	E003629	EE-EP 1462442 B1	2009, 6
C07C 323/32	E003630	EE-EP 1667964 B1	2009, 6
C07C 323/52	E003308	EE-EP 1554240 B1	2009, 4
C07C 401/00	E002906	EE-EP 1453798 B1	2009, 2
C07D 205/04	E003107	EE-EP 1513806 B1	2009, 3
C07D 205/08	E003108	EE-EP 1862455 B1	2009, 3
C07D 207/12	E003109	EE-EP 1928821 B1	2009, 3
C07D 207/16	E003110	EE-EP 1542968 B1	2009, 3
C07D 207/335	E003631	EE-EP 1471054 B1	2009, 6
C07D 207/34	E003111	EE-EP 1851198 B1	2009, 3
C07D 207/48	E003477	EE-EP 1861365 B1	2009, 5
C07D 209/08	E003478	EE-EP 1678135 B1	2009, 5
C07D 209/30	E002701	EE-EP 1809602 B1	2009, 1
C07D 209/30	E003112	EE-EP 1771415 B1	2009, 3
C07D 209/30	E003309	EE-EP 1656346 B1	2009, 4
C07D 209/34	E003113	EE-EP 1751106 B1	2009, 3
C07D 209/34	E003114	EE-EP 1751105 B1	2009, 3
C07D 209/34	E003632	EE-EP 1776339 B1	2009, 6
C07D 209/42	E002907	EE-EP 1776340 B1	2009, 2
C07D 209/42	E003310	EE-EP 1885695 B1	2009, 4
C07D 209/42	E003633	EE-EP 1861367 B1	2009, 6
C07D 209/48	E002908	EE-EP 1663970 B1	2009, 2
C07D 209/80	E002909	EE-EP 1470107 B1	2009, 2
C07D 209/82	E002702	EE-EP 1765776 B1	2009, 1
C07D 209/86	E002703	EE-EP 1732892 B1	2009, 1
C07D 209/88	E003311	EE-EP 1558575 B1	2009, 4
C07D 211/06	E002704	EE-EP 1587789 B1	2009, 1
C07D 211/18	E002910	EE-EP 1685105 B1	2009, 2
C07D 211/22	E003312	EE-EP 1567493 B1	2009, 4
C07D 213/02	E003115	EE-EP 1862458 B1	2009, 3
C07D 213/60	E002705	EE-EP 1674456 B1	2009, 1
C07D 213/65	E002706	EE-EP 1748043 B1	2009, 1
C07D 213/65	E003634	EE-EP 1979321 B1	2009, 6
C07D 213/73	E002911	EE-EP 1603877 B1	2009, 2
C07D 213/74	E002912	EE-EP 1757586 B1	2009, 2
C07D 213/74	E003116	EE-EP 1727801 B1	2009, 3
C07D 213/74	E003313	EE-EP 1771421 B1	2009, 4
C07D 213/79	E003117	EE-EP 1601653 B1	2009, 3
C07D 215/12	E002707	EE-EP 1753723 B1	2009, 1
C07D 215/26	E003635	EE-EP 1599450 B1	2009, 6
C07D 217/02	E002913	EE-EP 1658269 B1	2009, 2
C07D 223/00	E003636	EE-EP 1633719 B1	2009, 6
C07D 223/10	E003118	EE-EP 1680405 B1	2009, 3

Rahvusvahelise patendiklassifikatsiooni indeks	Registreeringu number	Patendikirjelduse tõlke number	Patendilehe number, kus avaldati Euroopa patendikirjelduse tõlke esitamise teade
C07D 223/16	E002708	EE-EP 1695965 B1	2009, 1
C07D 223/16	E003637	EE-EP 1924560 B1	2009, 6
C07D 223/16	E003638	EE-EP 1670768 B1	2009, 6
C07D 223/16	E003639	EE-EP 1926712 B1	2009, 6
C07D 223/18	E003314	EE-EP 1711470 B1	2009, 4
C07D 223/22	E003315	EE-EP 1789395 B1	2009, 4
C07D 231/12	E003119	EE-EP 1492773 B1	2009, 3
C07D 231/16	E002709	EE-EP 1833799 B1	2009, 1
C07D 231/20	E003479	EE-EP 1689720 B1	2009, 5
C07D 231/44	E003120	EE-EP 1879869 B1	2009, 3
C07D 231/54	E002710	EE-EP 1747201 B1	2009, 1
C07D 231/56	E003121	EE-EP 1797042 B1	2009, 3
C07D 233/28	E002914	EE-EP 1725536 B1	2009, 2
C07D 233/90	E002711	EE-EP 1756066 B1	2009, 1
C07D 233/90	E002915	EE-EP 1438296 B1	2009, 2
C07D 235/08	E003122	EE-EP 1626964 B1	2009, 3
C07D 235/08	E003316	EE-EP 1670769 B1	2009, 4
C07D 237/32	E002712	EE-EP 1427708 B1	2009, 1
C07D 239/42	E003317	EE-EP 1663989 B1	2009, 4
C07D 239/42	E003640	EE-EP 1701944 B1	2009, 6
C07D 239/46	E002713	EE-EP 1644340 B1	2009, 1
C07D 239/46	E003641	EE-EP 1483247 B1	2009, 6
C07D 239/48	E003318	EE-EP 1673352 B1	2009, 4
C07D 239/48	E003319	EE-EP 1456182 B1	2009, 4
C07D 239/70	E003320	EE-EP 1673354 B1	2009, 4
C07D 239/90	E003642	EE-EP 1546119 B1	2009, 6
C07D 239/91	E003123	EE-EP 1569916 B1	2009, 3
C07D 239/94	E002714	EE-EP 1597239 B1	2009, 1
C07D 243/02	E002916	EE-EP 1660462 B1	2009, 2
C07D 249/08	E002715	EE-EP 1606269 B1	2009, 1
C07D 251/10	E003124	EE-EP 1611111 B1	2009, 3
C07D 263/32	E003480	EE-EP 1786790 B1	2009, 5
C07D 263/58	E002716	EE-EP 1485363 B1	2009, 1
C07D 263/58	E003125	EE-EP 1919883 B1	2009, 3
C07D 277/20	E002717	EE-EP 1567112 B1	2009, 1
C07D 277/82	E003481	EE-EP 1828154 B1	2009, 5
C07D 279/16	E002917	EE-EP 1844029 B1	2009, 2
C07D 281/10	E003126	EE-EP 1694658 B1	2009, 3
C07D 295/02	E002918	EE-EP 1917254 B1	2009, 2
C07D 307/79	E002718	EE-EP 1408036 B1	2009, 1
C07D 307/93	E002719	EE-EP 1412342 B1	2009, 1
C07D 309/38	E002919	EE-EP 1417196 B1	2009, 2
C07D 311/18	E002920	EE-EP 1763520 B1	2009, 2
C07D 311/60	E002720	EE-EP 1812417 B1	2009, 1
C07D 311/72	E003321	EE-EP 1664012 B1	2009, 4
C07D 319/06	E002721	EE-EP 1537096 B1	2009, 1
C07D 333/20	E003643	EE-EP 1937662 B1	2009, 6
C07D 333/36	E002921	EE-EP 1893597 B1	2009, 2
C07D 333/38	E002722	EE-EP 1642897 B1	2009, 1
C07D 333/38	E003482	EE-EP 1511740 B1	2009, 5
C07D 333/54	E003644	EE-EP 1644350 B1	2009, 6
C07D 333/78	E002723	EE-EP 1805163 B1	2009, 1
C07D 335/02	E003483	EE-EP 1599461 B1	2009, 5
C07D 401/04	E002724	EE-EP 1891038 B1	2009, 1
C07D 401/04	E002725	EE-EP 1615909 B1	2009, 1
C07D 401/04	E002726	EE-EP 1828164 B1	2009, 1
C07D 401/04	E002727	EE-EP 1863791 B1	2009, 1

Rahvusvahelise patendiklassifikatsiooni indeks	Registreeringu number	Patendikirjelduse tõlke number	Patendilehe number, kus avaldati Euroopa patendikirjelduse tõlke esitamise teade
C07D 401/04	E002922	EE-EP 1492785 B1	2009, 2
C07D 401/04	E002923	EE-EP 1751131 B1	2009, 2
C07D 401/04	E002924	EE-EP 1664016 B1	2009, 2
C07D 401/04	E002925	EE-EP 1761515 B1	2009, 2
C07D 401/04	E003127	EE-EP 1756084 B1	2009, 3
C07D 401/04	E003128	EE-EP 1425277 B1	2009, 3
C07D 401/04	E003322	EE-EP 1427720 B1	2009, 4
C07D 401/04	E003323	EE-EP 1641775 B1	2009, 4
C07D 401/04	E003484	EE-EP 1656365 B1	2009, 5
C07D 401/04	E003485	EE-EP 1648878 B1	2009, 5
C07D 401/04	E003488	EE-EP 1867644 B1	2009, 5
C07D 401/04	E003645	EE-EP 1732917 B1	2009, 6
C07D 401/06	E003129	EE-EP 1904477 B1	2009, 3
C07D 401/12	E002728	EE-EP 1858881 B1	2009, 1
C07D 401/12	E002926	EE-EP 1732918 B1	2009, 2
C07D 401/12	E002927	EE-EP 1426371 B1	2009, 2
C07D 401/12	E003130	EE-EP 1664026 B1	2009, 3
C07D 401/12	E003325	EE-EP 1765807 B1	2009, 4
C07D 401/12	E003326	EE-EP 1660482 B1	2009, 4
C07D 401/12	E003486	EE-EP 1828166 B1	2009, 5
C07D 401/12	E003487	EE-EP 1963304 B1	2009, 5
C07D 401/12	E003646	EE-EP 1757601 B1	2009, 6
C07D 401/12	E003647	EE-EP 1899322 B1	2009, 6
C07D 401/14	E002729	EE-EP 1606283 B1	2009, 1
C07D 401/14	E002928	EE-EP 1532138 B1	2009, 2
C07D 401/14	E002929	EE-EP 1606282 B1	2009, 2
C07D 401/14	E003489	EE-EP 1981874 B1	2009, 5
C07D 403/04	E003490	EE-EP 1725544 B1	2009, 5
C07D 403/06	E003648	EE-EP 1928858 B1	2009, 6
C07D 403/06	E003649	EE-EP 1856102 B1	2009, 6
C07D 403/12	E002730	EE-EP 1873152 B1	2009, 1
C07D 403/12	E003491	EE-EP 1776358 B1	2009, 5
C07D 403/14	E003650	EE-EP 1847539 B1	2009, 6
C07D 403/14	E003651	EE-EP 1592686 B1	2009, 6
C07D 403/14	E003652	EE-EP 1753748 B1	2009, 6
C07D 405/04	E002930	EE-EP 1408038 B1	2009, 2
C07D 405/06	E002931	EE-EP 1874762 B1	2009, 2
C07D 405/12	E003324	EE-EP 1620429 B1	2009, 4
C07D 405/12	E003653	EE-EP 1844039 B1	2009, 6
C07D 405/14	E003654	EE-EP 1678166 B1	2009, 6
C07D 409/04	E002731	EE-EP 1778680 B1	2009, 1
C07D 409/04	E003655	EE-EP 1989200 B1	2009, 6
C07D 409/12	E002932	EE-EP 1805169 B1	2009, 2
C07D 413/06	E003492	EE-EP 1445258 B1	2009, 5
C07D 413/06	E003656	EE-EP 1756096 B1	2009, 6
C07D 413/12	E002732	EE-EP 1487828 B1	2009, 1
C07D 413/12	E003493	EE-EP 1934207 B1	2009, 5
C07D 413/14	E003131	EE-EP 1753757 B1	2009, 3
C07D 413/14	E003657	EE-EP 1857457 B1	2009, 6
C07D 413/14	E003658	EE-EP 1987026 B1	2009, 6
C07D 417/12	E003494	EE-EP 1740583 B1	2009, 5
C07D 451/04	E003132	EE-EP 1773829 B1	2009, 3
C07D 451/04	E003133	EE-EP 1735304 B1	2009, 3
C07D 455/06	E002733	EE-EP 1716145 B1	2009, 1
C07D 471/00	E002734	EE-EP 1509521 B1	2009, 1
C07D 471/04	E002735	EE-EP 1648889 B1	2009, 1
C07D 471/04	E002736	EE-EP 1497290 B1	2009, 1

Rahvusvahelise patendiklassifikatsiooni indeks	Registreeringu number	Patendikirjelduse tõlke number	Patendilehe number, kus avaldati Euroopa patendikirjelduse tõlke esitamise teade
C07D 471/04	E002737	EE-EP 1778686 B1	2009, 1
C07D 471/04	E002933	EE-EP 1638969 B1	2009, 2
C07D 471/04	E002934	EE-EP 1753764 B1	2009, 2
C07D 471/04	E002935	EE-EP 1636228 B1	2009, 2
C07D 471/04	E003134	EE-EP 1899333 B1	2009, 3
C07D 471/04	E003135	EE-EP 1740584 B1	2009, 3
C07D 471/04	E003136	EE-EP 1851217 B1	2009, 3
C07D 471/04	E003137	EE-EP 1902054 B1	2009, 3
C07D 471/04	E003138	EE-EP 1924580 B1	2009, 3
C07D 471/04	E003139	EE-EP 1853601 B1	2009, 3
C07D 471/04	E003140	EE-EP 1675852 B1	2009, 3
C07D 471/04	E003328	EE-EP 1555265 B1	2009, 4
C07D 471/04	E003329	EE-EP 1747220 B1	2009, 4
C07D 471/04	E003331	EE-EP 1841765 B1	2009, 4
C07D 471/04	E003495	EE-EP 1601673 B1	2009, 5
C07D 471/04	E003496	EE-EP 1713805 B1	2009, 5
C07D 471/04	E003659	EE-EP 1427415 B1	2009, 6
C07D 471/04	E003660	EE-EP 1877409 B1	2009, 6
C07D 471/08	E003661	EE-EP 1603910 B1	2009, 6
C07D 471/10	E003141	EE-EP 1509523 B1	2009, 3
C07D 473/00	E002936	EE-EP 1841768 B1	2009, 2
C07D 473/00	E003497	EE-EP 1838710 B1	2009, 5
C07D 473/04	E003498	EE-EP 1758905 B1	2009, 5
C07D 473/06	E002738	EE-EP 1622908 B1	2009, 1
C07D 487/00	E003499	EE-EP 1718649 B1	2009, 5
C07D 487/04	E002937	EE-EP 1549652 B1	2009, 2
C07D 487/04	E002938	EE-EP 1668014 B1	2009, 2
C07D 487/04	E003142	EE-EP 1869049 B1	2009, 3
C07D 487/04	E003327	EE-EP 1419160 B1	2009, 4
C07D 487/04	E003330	EE-EP 1719773 B1	2009, 4
C07D 487/04	E003500	EE-EP 1608653 B1	2009, 5
C07D 487/04	E003663	EE-EP 1699797 B1	2009, 6
C07D 487/04	E003664	EE-EP 1740591 B1	2009, 6
C07D 487/06	E002739	EE-EP 1585749 B1	2009, 1
C07D 487/08	E003501	EE-EP 1861405 B1	2009, 5
C07D 487/14	E003502	EE-EP 1622912 B1	2009, 5
C07D 487/22	E002939	EE-EP 1883641 B1	2009, 2
C07D 489/02	E002740	EE-EP 1711502 B1	2009, 1
C07D 491/00	E002741	EE-EP 1458723 B1	2009, 1
C07D 491/04	E003143	EE-EP 1917267 B1	2009, 3
C07D 491/04	E003662	EE-EP 1789419 B1	2009, 6
C07D 491/10	E003332	EE-EP 1697379 B1	2009, 4
C07D 491/22	E002742	EE-EP 1719775 B1	2009, 1
C07D 491/22	E002940	EE-EP 1603919 B1	2009, 2
C07D 493/04	E002941	EE-EP 1907396 B1	2009, 2
C07D 493/04	E003144	EE-EP 1668017 B1	2009, 3
C07D 493/04	E003503	EE-EP 1725566 B1	2009, 5
C07D 495/04	E002743	EE-EP 1626974 B1	2009, 1
C07D 495/04	E002942	EE-EP 1554284 B1	2009, 2
C07D 495/04	E002943	EE-EP 1598358 B1	2009, 2
C07D 495/04	E003145	EE-EP 1648905 B1	2009, 3
C07D 495/04	E003333	EE-EP 1899354 B1	2009, 4
C07D 495/04	E003665	EE-EP 1874781 B1	2009, 6
C07D 498/00	E002744	EE-EP 1713813 B1	2009, 1
C07D 498/04	E002745	EE-EP 1678185 B1	2009, 1
C07D 498/04	E002746	EE-EP 1749011 B1	2009, 1
C07D 498/10	E003666	EE-EP 1910381 B1	2009, 6

Rahvusvahelise patendiklassifikatsiooni indeks	Registreeringu number	Patendikirjelduse tõlke number	Patendilehe number, kus avaldati Euroopa patendikirjelduse tõlke esitamise teade
C07D 498/22	E003146	EE-EP 1676847 B1	2009, 3
C07D 498/22	E003147	EE-EP 1676848 B1	2009, 3
C07D 513/04	E002944	EE-EP 1745054 B1	2009, 2
C07D 513/04	E002945	EE-EP 1543013 B1	2009, 2
C07D 513/04	E003504	EE-EP 1704154 B1	2009, 5
C07D 513/06	E003334	EE-EP 1856132 B1	2009, 4
C07F 5/02	E003148	EE-EP 1768988 B1	2009, 3
C07F 5/02	E003667	EE-EP 1660507 B1	2009, 6
C07F 9/117	E003149	EE-EP 1896489 B1	2009, 3
C07F 9/58	E002946	EE-EP 1711507 B1	2009, 2
C07F 9/6561	E002947	EE-EP 1799696 B1	2009, 2
C07F 15/00	E003505	EE-EP 1789427 B1	2009, 5
C07H 7/04	E002948	EE-EP 1791852 B1	2009, 2
C07H 9/04	E002949	EE-EP 1599490 B1	2009, 2
C07H 11/00	E003335	EE-EP 1625135 B1	2009, 4
C07H 15/248	E003150	EE-EP 1631574 B1	2009, 3
C07H 17/00	E002950	EE-EP 1523488 B1	2009, 2
C07H 17/00	E002951	EE-EP 1888613 B1	2009, 2
C07H 17/08	E002952	EE-EP 1532131 B1	2009, 2
C07H 19/01	E002747	EE-EP 1421094 B1	2009, 1
C07H 19/06	E003506	EE-EP 1572711 B1	2009, 5
C07H 19/073	E003668	EE-EP 1904511 B1	2009, 6
C07J 1/00	E002748	EE-EP 1685150 B1	2009, 1
C07J 1/00	E002953	EE-EP 1805201 B1	2009, 2
C07J 1/00	E003669	EE-EP 1633771 B1	2009, 6
C07J 9/00	E002954	EE-EP 1776377 B1	2009, 2
C07J 21/00	E003670	EE-EP 1622926 B1	2009, 6
C07J 53/00	E003671	EE-EP 1831240 B1	2009, 6
C07J 63/00	E002955	EE-EP 1594885 B1	2009, 2
C07K 1/00	E003507	EE-EP 1546185 B1	2009, 5
C07K 5/06	E003151	EE-EP 1517915 B1	2009, 3
C07K 5/08	E002956	EE-EP 1833842 B1	2009, 2
C07K 7/06	E002749	EE-EP 1507795 B1	2009, 1
C07K 7/06	E002750	EE-EP 1734049 B1	2009, 1
C07K 7/06	E002957	EE-EP 1734048 B1	2009, 2
C07K 7/64	E002958	EE-EP 1753776 B1	2009, 2
C07K 14/00	E003152	EE-EP 1551868 B1	2009, 3
C07K 14/00	E003508	EE-EP 1468014 B1	2009, 5
C07K 14/00	E003672	EE-EP 1675579 B1	2009, 6
C07K 14/025	E003336	EE-EP 1506222 B1	2009, 4
C07K 14/03	E003337	EE-EP 1539808 B1	2009, 4
C07K 14/16	E002751	EE-EP 1652857 B1	2009, 1
C07K 14/18	E002752	EE-EP 1629004 B1	2009, 1
C07K 14/195	E003673	EE-EP 1597274 B1	2009, 6
C07K 14/47	E003674	EE-EP 1760089 B1	2009, 6
C07K 14/47	E003675	EE-EP 1651668 B1	2009, 6
C07K 14/50	E003509	EE-EP 1831252 B1	2009, 5
C07K 14/505	E003338	EE-EP 1629007 B1	2009, 4
C07K 14/505	E003510	EE-EP 1781697 B1	2009, 5
C07K 14/52	E002959	EE-EP 1437365 B1	2009, 2
C07K 14/52	E003676	EE-EP 1752470 B1	2009, 6
C07K 14/525	E002960	EE-EP 1465912 B1	2009, 2
C07K 14/575	E003339	EE-EP 1846445 B1	2009, 4
C07K 14/605	E003340	EE-EP 1819729 B1	2009, 4
C07K 14/655	E003677	EE-EP 1648934 B1	2009, 6
C07K 14/705	E002961	EE-EP 1701978 B1	2009, 2
C07K 14/71	E003341	EE-EP 1639007 B1	2009, 4

Rahvusvahelise patendiklassifikatsiooni indeks	Registreeringu number	Patendikirjelduse tõlke number	Patendilehe number, kus avaldati Euroopa patendikirjelduse tõlke esitamise teade
C07K 14/71	E003511	EE-EP 1548032 B1	2009, 5
C07K 14/75	E003678	EE-EP 1735345 B1	2009, 6
C07K 14/755	E003153	EE-EP 1673391 B1	2009, 3
C07K 14/77	E003679	EE-EP 1655308 B1	2009, 6
C07K 16/00	E002962	EE-EP 1752471 B1	2009, 2
C07K 16/00	E003154	EE-EP 1772465 B1	2009, 3
C07K 16/00	E003342	EE-EP 1699826 B1	2009, 4
C07K 16/00	E003680	EE-EP 1706424 B1	2009, 6
C07K 16/12	E003155	EE-EP 1446425 B1	2009, 3
C07K 16/22	E003681	EE-EP 1711530 B1	2009, 6
C07K 16/24	E002963	EE-EP 1639011 B1	2009, 2
C07K 16/24	E003682	EE-EP 1527100 B1	2009, 6
C07K 16/28	E003512	EE-EP 1817345 B1	2009, 5
C07K 16/28	E003683	EE-EP 1654286 B1	2009, 6
C07K 16/30	E003156	EE-EP 1585770 B1	2009, 3
C07K 19/00	E003684	EE-EP 1606318 B1	2009, 6
C08B 7/00	E003157	EE-EP 1863851 B1	2009, 3
C08B 31/00	E002753	EE-EP 1398327 B1	2009, 1
C08B 37/00	E003158	EE-EP 1791872 B1	2009, 3
C08B 37/00	E003343	EE-EP 1458763 B1	2009, 4
C08B 37/00	E003685	EE-EP 1620470 B1	2009, 6
C08F 2/44	E002754	EE-EP 1807453 B1	2009, 1
C08G 18/08	E003513	EE-EP 1899394 B1	2009, 5
C08G 18/38	E002964	EE-EP 1789464 B1	2009, 2
C08G 18/68	E003514	EE-EP 1917286 B1	2009, 5
C08G 18/75	E003344	EE-EP 1717257 B1	2009, 4
C08G 65/00	E002965	EE-EP 1902085 B1	2009, 2
C08G 69/14	E003159	EE-EP 1571173 B1	2009, 3
C08G 73/02	E002966	EE-EP 1854826 B1	2009, 2
C08G 73/02	E003686	EE-EP 2009042 B1	2009, 6
C08G 81/02	E003160	EE-EP 1784437 B1	2009, 3
C08J 5/00	E002967	EE-EP 1836239 B1	2009, 2
C08J 9/00	E002755	EE-EP 1731552 B1	2009, 1
C08J 9/30	E002756	EE-EP 1471104 B1	2009, 1
C08K 5/00	E003161	EE-EP 1641870 B1	2009, 3
C08K 5/098	E003687	EE-EP 1697454 B1	2009, 6
C08K 9/10	E002968	EE-EP 1915424 B1	2009, 2
C09D 5/03	E002969	EE-EP 1877501 B1	2009, 2
C09D 11/02	E003162	EE-EP 1790701 B1	2009, 3
C09D 127/12	E002970	EE-EP 1633825 B1	2009, 2
C09D 175/04	E003163	EE-EP 1717284 B1	2009, 3
C09J 5/04	E003164	EE-EP 1627022 B1	2009, 3
C09J 5/04	E003688	EE-EP 1629057 B1	2009, 6
C10G 3/00	E003689	EE-EP 1976960 B1	2009, 6
C10G 27/04	E003345	EE-EP 1668095 B1	2009, 4
C11D 3/39	E002757	EE-EP 1730258 B1	2009, 1
C12M 1/00	E003515	EE-EP 1891200 B1	2009, 5
C12M 1/113	E002971	EE-EP 1794280 B1	2009, 2
C12M 3/04	E003165	EE-EP 1733024 B1	2009, 3
C12N 1/20	E002758	EE-EP 1485463 B1	2009, 1
C12N 1/21	E003346	EE-EP 1476539 B1	2009, 4
C12N 5/06	E002759	EE-EP 1644484 B1	2009, 1
C12N 5/06	E003690	EE-EP 1636348 B1	2009, 6
C12N 5/08	E002972	EE-EP 1633859 B1	2009, 2
C12N 7/04	E003166	EE-EP 1751276 B1	2009, 3
C12N 7/06	E003691	EE-EP 1597359 B1	2009, 6
C12N 9/10	E002760	EE-EP 1670906 B1	2009, 1

Rahvusvahelise patendiklassifikatsiooni indeks	Registreeringu number	Patendikirjelduse tõlke number	Patendilehe number, kus avaldati Euroopa patendikirjelduse tõlke esitamise teade
C12N 9/12	E003347	EE-EP 1509600 B1	2009, 4
C12N 9/48	E003692	EE-EP 1432793 B1	2009, 6
C12N 15/11	E002973	EE-EP 1608753 B1	2009, 2
C12N 15/11	E003167	EE-EP 1805305 B1	2009, 3
C12N 15/11	E003168	EE-EP 1805306 B1	2009, 3
C12N 15/11	E003169	EE-EP 1805307 B1	2009, 3
C12N 15/12	E002761	EE-EP 1449920 B1	2009, 1
C12N 15/61	E003170	EE-EP 1468093 B1	2009, 3
C12N 15/62	E002974	EE-EP 1409692 B1	2009, 2
C12N 15/67	E003693	EE-EP 1578949 B1	2009, 6
C12N 15/82	E003694	EE-EP 1805312 B1	2009, 6
C12N 15/85	E002975	EE-EP 1525320 B1	2009, 2
C12P 7/62	E003348	EE-EP 1637610 B1	2009, 4
C12P 7/66	E003516	EE-EP 1803820 B1	2009, 5
C12P 13/00	E003695	EE-EP 1745136 B1	2009, 6
C12P 19/56	E003696	EE-EP 1745140 B1	2009, 6
C12P 21/02	E002976	EE-EP 1833978 B1	2009, 2
C12P 21/04	E003171	EE-EP 1572967 B1	2009, 3
C12Q 1/00	E002762	EE-EP 1612275 B1	2009, 1
C12Q 1/26	E002763	EE-EP 1509618 B1	2009, 1
C12Q 1/44	E002764	EE-EP 1456405 B1	2009, 1
C12Q 1/68	E002765	EE-EP 1597391 B1	2009, 1
C12Q 1/68	E002977	EE-EP 1567667 B1	2009, 2
C12Q 1/68	E003517	EE-EP 1654387 B1	2009, 5
C12Q 1/68	E003697	EE-EP 1529116 B1	2009, 6
C12R 1/19	E002766	EE-EP 1636389 B1	2009, 1
C12R 1/42	E002767	EE-EP 1476582 B1	2009, 1
C13D 1/08	E003518	EE-EP 1576195 B1	2009, 5
C21D 8/02	E002978	EE-EP 1662011 B1	2009, 2
C21D 8/02	E003172	EE-EP 1662010 B1	2009, 3
C22B 7/00	E003519	EE-EP 1354968 B1	2009, 5
C22B 21/00	E002768	EE-EP 1851347 B1	2009, 1
C22C 5/04	E003520	EE-EP 1917370 B1	2009, 5
C22C 16/00	E003173	EE-EP 1817439 B1	2009, 3
C22C 38/44	E003521	EE-EP 1920079 B1	2009, 5
C23C 2/12	E003174	EE-EP 1458899 B1	2009, 3
C23C 14/34	E002979	EE-EP 1856303 B1	2009, 2
C23C 14/34	E003175	EE-EP 1556526 B1	2009, 3
C23C 14/34	E003176	EE-EP 1799876 B1	2009, 3
C23G 5/06	E003349	EE-EP 1649079 B1	2009, 4
C25B 9/18	E003522	EE-EP 1969159 B1	2009, 5
D01B 1/10	E003523	EE-EP 1637631 B1	2009, 5
D01D 1/02	E002769	EE-EP 1694888 B1	2009, 1
D01D 5/00	E002770	EE-EP 1867762 B1	2009, 1
D02G 3/44	E002771	EE-EP 1760175 B1	2009, 1
D02J 1/22	E003524	EE-EP 1306471 B1	2009, 5
D03D 3/02	E003525	EE-EP 1371762 B1	2009, 5
D04H 5/02	E003526	EE-EP 2050850 B1	2009, 5
D05C 17/02	E003527	EE-EP 1967631 B1	2009, 5
D06H 5/00	E003177	EE-EP 1633921 B1	2009, 3
D06M 15/643	E003698	EE-EP 1598475 B1	2009, 6
D06M 17/08	E003178	EE-EP 1600552 B1	2009, 3
D21H 17/21	E003350	EE-EP 1682721 B1	2009, 4
D21H 27/18	E003179	EE-EP 1536065 B1	2009, 3
D21H 27/20	E003528	EE-EP 1713976 B1	2009, 5
E01B 3/32	E002772	EE-EP 1384812 B1	2009, 1
E01B 5/14	E002773	EE-EP 1523597 B1	2009, 1

Rahvusvahelise patendiklassifikatsiooni indeks	Registreeringu number	Patendikirjelduse tõlke number	Patendilehe number, kus avaldati Euroopa patendikirjelduse tõlke esitamise teade
E01B 7/20	E003180	EE-EP 1749937 B1	2009, 3
E01B 9/14	E002980	EE-EP 1449961 B1	2009, 2
E01B 29/26	E003699	EE-EP 1612330 B1	2009, 6
E01C 5/00	E003351	EE-EP 1893811 B1	2009, 4
E01C 9/04	E002981	EE-EP 1846617 B1	2009, 2
E01D 15/127	E003352	EE-EP 1907629 B1	2009, 4
E01F 15/04	E003700	EE-EP 1777346 B1	2009, 6
E02B 3/06	E002982	EE-EP 1964978 B1	2009, 2
E02D 5/36	E002774	EE-EP 1849919 B1	2009, 1
E02D 17/13	E002983	EE-EP 1752583 B1	2009, 2
E02D 29/02	E003701	EE-EP 1951963 B1	2009, 6
E02D 29/14	E003181	EE-EP 1910626 B1	2009, 3
E02D 29/14	E003702	EE-EP 1818458 B1	2009, 6
E02F 3/92	E003182	EE-EP 1786982 B1	2009, 3
E02F 3/96	E003703	EE-EP 1571265 B1	2009, 6
E03B 1/04	E003704	EE-EP 1979552 B1	2009, 6
E03F 5/06	E002984	EE-EP 1525354 B1	2009, 2
E04B 1/21	E002985	EE-EP 1405957 B1	2009, 2
E04B 1/344	E003529	EE-EP 1590537 B1	2009, 5
E04B 1/348	E003353	EE-EP 1733100 B1	2009, 4
E04B 1/41	E003354	EE-EP 1589156 B1	2009, 4
E04B 1/74	E002775	EE-EP 1507046 B1	2009, 1
E04B 1/76	E003183	EE-EP 1643046 B1	2009, 3
E04B 1/78	E002776	EE-EP 1900884 B1	2009, 1
E04B 1/78	E002986	EE-EP 1754840 B1	2009, 2
E04B 2/00	E002987	EE-EP 1509660 B1	2009, 2
E04B 2/56	E002988	EE-EP 1536077 B1	2009, 2
E04B 5/40	E002777	EE-EP 1689948 B1	2009, 1
E04B 9/06	E002778	EE-EP 1631728 B1	2009, 1
E04C 2/292	E002779	EE-EP 1489243 B1	2009, 1
E04C 2/42	E002780	EE-EP 1573144 B1	2009, 1
E04C 2/42	E002989	EE-EP 1724409 B1	2009, 2
E04F 13/06	E003530	EE-EP 1873325 B1	2009, 5
E04F 13/18	E003355	EE-EP 1524385 B1	2009, 4
E04F 15/02	E003705	EE-EP 1809833 B1	2009, 6
E04F 15/04	E002781	EE-EP 1534908 B1	2009, 1
E04F 15/04	E003706	EE-EP 1691005 B1	2009, 6
E04F 19/06	E003184	EE-EP 1555360 B1	2009, 3
E04F 19/06	E003531	EE-EP 1705312 B1	2009, 5
E04G 11/06	E002782	EE-EP 1537281 B1	2009, 1
E04G 17/06	E003185	EE-EP 1430191 B1	2009, 3
E04G 21/12	E002783	EE-EP 1902186 B1	2009, 1
E04G 23/00	E003707	EE-EP 1440215 B1	2009, 6
E04H 9/10	E003356	EE-EP 1807583 B1	2009, 4
E04H 9/14	E002784	EE-EP 1564350 B1	2009, 1
E04H 12/28	E003532	EE-EP 1597448 B1	2009, 5
E05B 15/02	E003708	EE-EP 1344881 B1	2009, 6
E05B 17/20	E003533	EE-EP 1702124 B1	2009, 5
E05B 27/00	E002990	EE-EP 1738044 B1	2009, 2
E05B 47/06	E003534	EE-EP 1689958 B1	2009, 5
E05B 65/00	E002991	EE-EP 1937919 B1	2009, 2
E05B 65/12	E002785	EE-EP 1482111 B1	2009, 1
E05C 17/28	E003535	EE-EP 1718829 B1	2009, 5
E05D 5/02	E003709	EE-EP 1630332 B1	2009, 6
E05D 15/26	E003710	EE-EP 1630337 B1	2009, 6
E05F 15/14	E002786	EE-EP 1710381 B1	2009, 1
E06B 1/16	E003357	EE-EP 1446545 B1	2009, 4

Rahvusvahelise patendiklassifikatsiooni indeks	Registreeringu number	Patendikirjelduse tõlke number	Patendilehe number, kus avaldati Euroopa patendikirjelduse tõlke esitamise teade
E06B 3/28	E002787	EE-EP 1691021 B1	2009, 1
E06B 3/30	E003186	EE-EP 1486636 B1	2009, 3
E21B 19/22	E002992	EE-EP 1781896 B1	2009, 2
E21B 31/107	E002993	EE-EP 1723307 B1	2009, 2
E21B 43/24	E002788	EE-EP 1738055 B1	2009, 1
E21D 21/00	E003187	EE-EP 1623095 B1	2009, 3
F01C 3/02	E002789	EE-EP 1585887 B1	2009, 1
F01K 25/10	E003188	EE-EP 1529928 B1	2009, 3
F02B 33/16	E003189	EE-EP 1911947 B1	2009, 3
F02B 33/22	E003536	EE-EP 1925795 B1	2009, 5
F02B 53/00	E003190	EE-EP 1639247 B1	2009, 3
F03D 1/06	E003191	EE-EP 1636490 B1	2009, 3
F03D 3/02	E002994	EE-EP 1623112 B1	2009, 2
F03D 11/00	E003537	EE-EP 1623115 B1	2009, 5
F03D 11/04	E003711	EE-EP 1476659 B1	2009, 6
F04B 7/00	E003538	EE-EP 1952021 B1	2009, 5
F04F 5/46	E002995	EE-EP 1636498 B1	2009, 2
F16B 11/00	E002790	EE-EP 1514029 B1	2009, 1
F16B 35/00	E002996	EE-EP 1750020 B1	2009, 2
F16F 7/12	E002791	EE-EP 1788273 B1	2009, 1
F16F 9/02	E002792	EE-EP 1606532 B1	2009, 1
F16J 15/16	E003712	EE-EP 1606538 B1	2009, 6
F16K 1/36	E003192	EE-EP 1760374 B1	2009, 3
F16K 24/04	E003539	EE-EP 1990566 B1	2009, 5
F16L 9/12	E003358	EE-EP 1536171 B1	2009, 4
F16L 27/08	E003713	EE-EP 1927806 B1	2009, 6
F16L 33/22	E002997	EE-EP 1812743 B1	2009, 2
F21S 8/00	E003540	EE-EP 1728023 B1	2009, 5
F21V 5/00	E003541	EE-EP 1848918 B1	2009, 5
F21V 31/00	E003714	EE-EP 1724522 B1	2009, 6
F23G 5/027	E003193	EE-EP 1896774 B1	2009, 3
F23H 3/02	E003359	EE-EP 1801499 B1	2009, 4
F24F 3/00	E003360	EE-EP 1830134 B1	2009, 4
F24H 9/00	E003715	EE-EP 1963755 B1	2009, 6
F25J 3/00	E002998	EE-EP 1828697 B1	2009, 2
F28F 9/26	E003542	EE-EP 1462755 B1	2009, 5
F41A 23/00	E002999	EE-EP 1715283 B1	2009, 2
F41H 5/04	E003194	EE-EP 1596153 B1	2009, 3
G01D 7/00	E002793	EE-EP 1655583 B1	2009, 1
G01N 1/20	E003000	EE-EP 1615014 B1	2009, 2
G01N 21/90	E003716	EE-EP 1955055 B1	2009, 6
G01N 27/403	E002794	EE-EP 1579204 B1	2009, 1
G01N 33/558	E003001	EE-EP 1644737 B1	2009, 2
G01N 33/561	E003195	EE-EP 1531332 B1	2009, 3
G01N 33/564	E002795	EE-EP 1721162 B1	2009, 1
G01N 33/564	E003002	EE-EP 1606621 B1	2009, 2
G01N 33/569	E003361	EE-EP 1820022 B1	2009, 4
G01N 33/574	E003196	EE-EP 1776587 B1	2009, 3
G01N 33/68	E002796	EE-EP 1587821 B1	2009, 1
G01N 33/68	E003362	EE-EP 1495330 B1	2009, 4
G01N 33/74	E003363	EE-EP 1636593 B1	2009, 4
G01S 1/00	E003197	EE-EP 1792196 B1	2009, 3
G01S 5/10	E003364	EE-EP 1896868 B1	2009, 4
G01S 5/14	E003717	EE-EP 2030039 B1	2009, 6
G01V 15/00	E003543	EE-EP 1438607 B1	2009, 5
G02B 6/00	E003198	EE-EP 1733263 B1	2009, 3
G02C 5/22	E003199	EE-EP 1907899 B1	2009, 3

Rahvusvahelise patendiklassifikatsiooni indeks	Registreeringu number	Patendikirjelduse tõlke number	Patendilehe number, kus avaldati Euroopa patendikirjelduse tõlke esitamise teade
G04B 17/06	E003365	EE-EP 1815300 B1	2009, 4
G06F 1/32	E003200	EE-EP 1657623 B1	2009, 3
G06F 9/44	E003718	EE-EP 1749264 B1	2009, 6
G06K 17/00	E003544	EE-EP 1719070 B1	2009, 5
G06K 19/077	E003003	EE-EP 1846874 B1	2009, 2
G06Q 10/00	E003004	EE-EP 1530771 B1	2009, 2
G06T 1/00	E002797	EE-EP 1715454 B1	2009, 1
G07C 9/00	E002798	EE-EP 1891607 B1	2009, 1
G07C 13/00	E003545	EE-EP 1469429 B1	2009, 5
G08C 17/02	E003366	EE-EP 1746556 B1	2009, 4
G08G 1/01	E003367	EE-EP 1442443 B1	2009, 4
G08G 1/16	E002799	EE-EP 1903534 B1	2009, 1
G09F 3/02	E003005	EE-EP 1278173 B1	2009, 2
G11B 17/028	E003201	EE-EP 1396855 B1	2009, 3
G21F 5/018	E003546	EE-EP 1474809 B1	2009, 5
H01B 1/00	E003719	EE-EP 1744326 B1	2009, 6
H01F 30/16	E003202	EE-EP 1797573 B1	2009, 3
H01J 61/24	E002800	EE-EP 1774566 B1	2009, 1
H01L 31/0352	E002801	EE-EP 1671355 B1	2009, 1
H01Q 1/34	E003006	EE-EP 1920497 B1	2009, 2
H01R 4/62	E003007	EE-EP 1796215 B1	2009, 2
H01R 12/32	E002802	EE-EP 1807906 B1	2009, 1
H02G 3/04	E002803	EE-EP 1511141 B1	2009, 1
H02G 3/04	E003008	EE-EP 1670110 B1	2009, 2
H02G 3/04	E003720	EE-EP 1701421 B1	2009, 6
H02G 3/06	E003721	EE-EP 1897196 B1	2009, 6
H02G 3/18	E002804	EE-EP 1667299 B1	2009, 1
H02G 13/00	E003368	EE-EP 1923976 B1	2009, 4
H02K 15/12	E002805	EE-EP 1541315 B1	2009, 1
H04B 1/707	E003722	EE-EP 1836778 B1	2009, 6
H04B 7/005	E003203	EE-EP 1506626 B1	2009, 3
H04B 7/06	E003009	EE-EP 1476959 B1	2009, 2
H04L 1/16	E003547	EE-EP 1845649 B1	2009, 5
H04L 9/06	E003369	EE-EP 1627489 B1	2009, 4
H04L 12/18	E003204	EE-EP 1564929 B1	2009, 3
H04L 12/28	E002806	EE-EP 1533943 B1	2009, 1
H04L 12/66	E002807	EE-EP 1728370 B1	2009, 1
H04L 29/06	E003548	EE-EP 1530861 B1	2009, 5
H04L 29/06	E003549	EE-EP 1955513 B1	2009, 5
H04M 7/00	E002808	EE-EP 1677507 B1	2009, 1
H04N 1/32	E003010	EE-EP 1433305 B1	2009, 2
H04N 7/173	E003011	EE-EP 1343324 B1	2009, 2
H04N 7/26	E003370	EE-EP 1779663 B1	2009, 4
H04Q 3/00	E002809	EE-EP 1797725 B1	2009, 1
H04Q 7/38	E003012	EE-EP 1584212 B1	2009, 2
H04Q 7/38	E003205	EE-EP 1650998 B1	2009, 3
H04R 17/00	E002810	EE-EP 1422970 B1	2009, 1
H04W 4/12	E003723	EE-EP 1688000 B1	2009, 6
H04W 8/04	E003550	EE-EP 1452059 B1	2009, 5
H04W 36/08	E003551	EE-EP 1566983 B1	2009, 5
H04W 36/08	E003724	EE-EP 1847149 B1	2009, 6
H05B 1/02	E003725	EE-EP 1652408 B1	2009, 6
H05B 33/00	E002811	EE-EP 1446985 B1	2009, 1

FG4A. EESTIS KEHTIVATE EUROOPA PATENTIDE NUMBRILINE LOEND

Registreeringu number	Patendikirjelduse tõlke number	Patendilehe number, kus avaldati Euroopa patendikirjelduse tõlke esitamise teade
-----------------------	--------------------------------	--

E002592	EE-EP 1643833 B1	2009, 1	E002647	EE-EP 1408981 B1	2009, 1
E002593	EE-EP 1482790 B1	2009, 1	E002648	EE-EP 1462107 B1	2009, 1
E002594	EE-EP 1860945 B1	2009, 1	E002649	EE-EP 1648484 B1	2009, 1
E002595	EE-EP 1413201 B1	2009, 1	E002650	EE-EP 1566179 B1	2009, 1
E002596	EE-EP 1672982 B1	2009, 1	E002651	EE-EP 1755634 B1	2009, 1
E002597	EE-EP 1796478 B1	2009, 1	E002652	EE-EP 1651247 B1	2009, 1
E002598	EE-EP 1793684 B1	2009, 1	E002653	EE-EP 1476558 B1	2009, 1
E002599	EE-EP 1759591 B1	2009, 1	E002654	EE-EP 1585546 B1	2009, 1
E002600	EE-EP 1685763 B1	2009, 1	E002655	EE-EP 1631312 B1	2009, 1
E002601	EE-EP 1729598 B1	2009, 1	E002656	EE-EP 1459765 B1	2009, 1
E002602	EE-EP 1549159 B1	2009, 1	E002657	EE-EP 1448234 B1	2009, 1
E002603	EE-EP 1618803 B1	2009, 1	E002658	EE-EP 1635875 B1	2009, 1
E002604	EE-EP 1830673 B1	2009, 1	E002659	EE-EP 1744789 B1	2009, 1
E002605	EE-EP 1882426 B1	2009, 1	E002660	EE-EP 1833518 B1	2009, 1
E002606	EE-EP 1759373 B1	2009, 1	E002661	EE-EP 1648531 B1	2009, 1
E002607	EE-EP 1761150 B1	2009, 1	E002662	EE-EP 1534352 B1	2009, 1
E002608	EE-EP 1610657 B1	2009, 1	E002663	EE-EP 1626749 B1	2009, 1
E002609	EE-EP 1466558 B1	2009, 1	E002664	EE-EP 1799286 B1	2009, 1
E002610	EE-EP 1787606 B1	2009, 1	E002665	EE-EP 1601397 B1	2009, 1
E002611	EE-EP 1605891 B1	2009, 1	E002666	EE-EP 1603610 B1	2009, 1
E002612	EE-EP 1635776 B1	2009, 1	E002667	EE-EP 1768728 B1	2009, 1
E002613	EE-EP 1594456 B1	2009, 1	E002668	EE-EP 1726327 B1	2009, 1
E002614	EE-EP 1603532 B1	2009, 1	E002669	EE-EP 1534388 B1	2009, 1
E002615	EE-EP 1906916 B1	2009, 1	E002670	EE-EP 1487541 B1	2009, 1
E002616	EE-EP 1543826 B1	2009, 1	E002671	EE-EP 1569724 B1	2009, 1
E002617	EE-EP 1765289 B1	2009, 1	E002672	EE-EP 1463575 B1	2009, 1
E002618	EE-EP 1537859 B1	2009, 1	E002673	EE-EP 1412078 B1	2009, 1
E002619	EE-EP 1675573 B1	2009, 1	E002674	EE-EP 1490182 B1	2009, 1
E002620	EE-EP 1819320 B1	2009, 1	E002675	EE-EP 1868748 B1	2009, 1
E002621	EE-EP 1455761 B1	2009, 1	E002676	EE-EP 1490190 B1	2009, 1
E002622	EE-EP 1838293 B1	2009, 1	E002677	EE-EP 1477275 B1	2009, 1
E002623	EE-EP 1708679 B1	2009, 1	E002678	EE-EP 1761370 B1	2009, 1
E002624	EE-EP 1646373 B1	2009, 1	E002679	EE-EP 1438172 B1	2009, 1
E002625	EE-EP 1677779 B1	2009, 1	E002680	EE-EP 1864791 B1	2009, 1
E002626	EE-EP 1635808 B1	2009, 1	E002681	EE-EP 1846253 B1	2009, 1
E002627	EE-EP 1532974 B1	2009, 1	E002682	EE-EP 1506888 B1	2009, 1
E002628	EE-EP 1720538 B1	2009, 1	E002683	EE-EP 1348609 B1	2009, 1
E002629	EE-EP 1411916 B1	2009, 1	E002684	EE-EP 1575828 B1	2009, 1
E002630	EE-EP 1740164 B1	2009, 1	E002685	EE-EP 1502859 B1	2009, 1
E002631	EE-EP 1427409 B1	2009, 1	E002686	EE-EP 1863718 B1	2009, 1
E002632	EE-EP 1515717 B1	2009, 1	E002687	EE-EP 1702859 B1	2009, 1
E002633	EE-EP 1713477 B1	2009, 1	E002688	EE-EP 1620323 B1	2009, 1
E002634	EE-EP 1827427 B1	2009, 1	E002689	EE-EP 1864917 B1	2009, 1
E002635	EE-EP 1796668 B1	2009, 1	E002690	EE-EP 1923336 B1	2009, 1
E002636	EE-EP 1465626 B1	2009, 1	E002691	EE-EP 1789351 B1	2009, 1
E002637	EE-EP 1626720 B1	2009, 1	E002692	EE-EP 1795479 B1	2009, 1
E002638	EE-EP 1458390 B1	2009, 1	E002693	EE-EP 1694599 B1	2009, 1
E002639	EE-EP 1879581 B1	2009, 1	E002694	EE-EP 1877351 B1	2009, 1
E002640	EE-EP 1881830 B1	2009, 1	E002695	EE-EP 1594833 B1	2009, 1
E002641	EE-EP 1601359 B1	2009, 1	E002696	EE-EP 1567474 B1	2009, 1
E002642	EE-EP 1689404 B1	2009, 1	E002697	EE-EP 1581474 B1	2009, 1
E002643	EE-EP 1653964 B1	2009, 1	E002698	EE-EP 1564202 B1	2009, 1
E002644	EE-EP 1769798 B1	2009, 1	E002699	EE-EP 1716108 B1	2009, 1
E002645	EE-EP 1596868 B1	2009, 1	E002700	EE-EP 1506171 B1	2009, 1
E002646	EE-EP 1706121 B1	2009, 1	E002701	EE-EP 1809602 B1	2009, 1

Registreeringu number	Patendikirjelduse tõlke number	Patendilehe number, kus avaldati Euroopa patendikirjelduse tõlke esitamise teade
-----------------------	--------------------------------	--

E002702	EE-EP 1765776 B1	2009, 1	E002759	EE-EP 1644484 B1	2009, 1
E002703	EE-EP 1732892 B1	2009, 1	E002760	EE-EP 1670906 B1	2009, 1
E002704	EE-EP 1587789 B1	2009, 1	E002761	EE-EP 1449920 B1	2009, 1
E002705	EE-EP 1674456 B1	2009, 1	E002762	EE-EP 1612275 B1	2009, 1
E002706	EE-EP 1748043 B1	2009, 1	E002763	EE-EP 1509618 B1	2009, 1
E002707	EE-EP 1753723 B1	2009, 1	E002764	EE-EP 1456405 B1	2009, 1
E002708	EE-EP 1695965 B1	2009, 1	E002765	EE-EP 1597391 B1	2009, 1
E002709	EE-EP 1833799 B1	2009, 1	E002766	EE-EP 1636389 B1	2009, 1
E002710	EE-EP 1747201 B1	2009, 1	E002767	EE-EP 1476582 B1	2009, 1
E002711	EE-EP 1756066 B1	2009, 1	E002768	EE-EP 1851347 B1	2009, 1
E002712	EE-EP 1427708 B1	2009, 1	E002769	EE-EP 1694888 B1	2009, 1
E002713	EE-EP 1644340 B1	2009, 1	E002770	EE-EP 1867762 B1	2009, 1
E002714	EE-EP 1597239 B1	2009, 1	E002771	EE-EP 1760175 B1	2009, 1
E002715	EE-EP 1606269 B1	2009, 1	E002772	EE-EP 1384812 B1	2009, 1
E002716	EE-EP 1485363 B1	2009, 1	E002773	EE-EP 1523597 B1	2009, 1
E002717	EE-EP 1567112 B1	2009, 1	E002774	EE-EP 1849919 B1	2009, 1
E002718	EE-EP 1408036 B1	2009, 1	E002775	EE-EP 1507046 B1	2009, 1
E002719	EE-EP 1412342 B1	2009, 1	E002776	EE-EP 1900884 B1	2009, 1
E002720	EE-EP 1812417 B1	2009, 1	E002777	EE-EP 1689948 B1	2009, 1
E002721	EE-EP 1537096 B1	2009, 1	E002778	EE-EP 1631728 B1	2009, 1
E002722	EE-EP 1642897 B1	2009, 1	E002779	EE-EP 1489243 B1	2009, 1
E002723	EE-EP 1805163 B1	2009, 1	E002780	EE-EP 1573144 B1	2009, 1
E002724	EE-EP 1891038 B1	2009, 1	E002781	EE-EP 1534908 B1	2009, 1
E002725	EE-EP 1615909 B1	2009, 1	E002782	EE-EP 1537281 B1	2009, 1
E002726	EE-EP 1828164 B1	2009, 1	E002783	EE-EP 1902186 B1	2009, 1
E002727	EE-EP 1863791 B1	2009, 1	E002784	EE-EP 1564350 B1	2009, 1
E002728	EE-EP 1858881 B1	2009, 1	E002785	EE-EP 1482111 B1	2009, 1
E002729	EE-EP 1606283 B1	2009, 1	E002786	EE-EP 1710381 B1	2009, 1
E002730	EE-EP 1873152 B1	2009, 1	E002787	EE-EP 1691021 B1	2009, 1
E002731	EE-EP 1778680 B1	2009, 1	E002788	EE-EP 1738055 B1	2009, 1
E002732	EE-EP 1487828 B1	2009, 1	E002789	EE-EP 1585887 B1	2009, 1
E002733	EE-EP 1716145 B1	2009, 1	E002790	EE-EP 1514029 B1	2009, 1
E002734	EE-EP 1509521 B1	2009, 1	E002791	EE-EP 1788273 B1	2009, 1
E002735	EE-EP 1648889 B1	2009, 1	E002792	EE-EP 1606532 B1	2009, 1
E002736	EE-EP 1497290 B1	2009, 1	E002793	EE-EP 1655583 B1	2009, 1
E002737	EE-EP 1778686 B1	2009, 1	E002794	EE-EP 1579204 B1	2009, 1
E002738	EE-EP 1622908 B1	2009, 1	E002795	EE-EP 1721162 B1	2009, 1
E002739	EE-EP 1585749 B1	2009, 1	E002796	EE-EP 1587821 B1	2009, 1
E002740	EE-EP 1711502 B1	2009, 1	E002797	EE-EP 1715454 B1	2009, 1
E002741	EE-EP 1458723 B1	2009, 1	E002798	EE-EP 1891607 B1	2009, 1
E002742	EE-EP 1719775 B1	2009, 1	E002799	EE-EP 1903534 B1	2009, 1
E002743	EE-EP 1626974 B1	2009, 1	E002800	EE-EP 1774566 B1	2009, 1
E002744	EE-EP 1713813 B1	2009, 1	E002801	EE-EP 1671355 B1	2009, 1
E002745	EE-EP 1678185 B1	2009, 1	E002802	EE-EP 1807906 B1	2009, 1
E002746	EE-EP 1749011 B1	2009, 1	E002803	EE-EP 1511141 B1	2009, 1
E002747	EE-EP 1421094 B1	2009, 1	E002804	EE-EP 1667299 B1	2009, 1
E002748	EE-EP 1685150 B1	2009, 1	E002805	EE-EP 1541315 B1	2009, 1
E002749	EE-EP 1507795 B1	2009, 1	E002806	EE-EP 1533943 B1	2009, 1
E002750	EE-EP 1734049 B1	2009, 1	E002807	EE-EP 1728370 B1	2009, 1
E002751	EE-EP 1652857 B1	2009, 1	E002808	EE-EP 1677507 B1	2009, 1
E002752	EE-EP 1629004 B1	2009, 1	E002809	EE-EP 1797725 B1	2009, 1
E002753	EE-EP 1398327 B1	2009, 1	E002810	EE-EP 1422970 B1	2009, 1
E002754	EE-EP 1807453 B1	2009, 1	E002811	EE-EP 1446985 B1	2009, 1
E002755	EE-EP 1731552 B1	2009, 1	E002812	EE-EP 1638385 B1	2009, 2
E002756	EE-EP 1471104 B1	2009, 1	E002813	EE-EP 1473984 B1	2009, 2
E002757	EE-EP 1730258 B1	2009, 1	E002814	EE-EP 1435780 B1	2009, 2
E002758	EE-EP 1485463 B1	2009, 1	E002815	EE-EP 1860941 B1	2009, 2

Registreeringu number	Patendikirjelduse tõlke number	Patendilehe number, kus avaldati Euroopa patendikirjelduse tõlke esitamise teade
-----------------------	--------------------------------	--

E002816	EE-EP 1734823 B1	2009, 2	E002873	EE-EP 1696954 B1	2009, 2
E002817	EE-EP 1705989 B1	2009, 2	E002874	EE-EP 1763369 B1	2009, 2
E002818	EE-EP 1484972 B1	2009, 2	E002875	EE-EP 1511516 B1	2009, 2
E002819	EE-EP 1675474 B1	2009, 2	E002876	EE-EP 1446162 B1	2009, 2
E002820	EE-EP 1845809 B1	2009, 2	E002877	EE-EP 1610834 B1	2009, 2
E002821	EE-EP 1605790 B1	2009, 2	E002878	EE-EP 1810702 B1	2009, 2
E002822	EE-EP 1416827 B1	2009, 2	E002879	EE-EP 1867349 B1	2009, 2
E002823	EE-EP 1523256 B1	2009, 2	E002880	EE-EP 1467785 B1	2009, 2
E002824	EE-EP 1764014 B1	2009, 2	E002881	EE-EP 1773431 B1	2009, 2
E002825	EE-EP 1686880 B1	2009, 2	E002882	EE-EP 1911498 B1	2009, 2
E002826	EE-EP 1733665 B1	2009, 2	E002883	EE-EP 1572315 B1	2009, 2
E002827	EE-EP 1747745 B1	2009, 2	E002884	EE-EP 1699545 B1	2009, 2
E002828	EE-EP 1646311 B1	2009, 2	E002885	EE-EP 1350580 B1	2009, 2
E002829	EE-EP 1575433 B1	2009, 2	E002886	EE-EP 1837097 B1	2009, 2
E002830	EE-EP 1647239 B1	2009, 2	E002887	EE-EP 1722945 B1	2009, 2
E002831	EE-EP 1550417 B1	2009, 2	E002888	EE-EP 1872918 B1	2009, 2
E002832	EE-EP 1743601 B1	2009, 2	E002889	EE-EP 1858679 B1	2009, 2
E002833	EE-EP 1689356 B1	2009, 2	E002890	EE-EP 1851023 B1	2009, 2
E002834	EE-EP 1811957 B1	2009, 2	E002891	EE-EP 1940603 B1	2009, 2
E002835	EE-EP 1792610 B1	2009, 2	E002892	EE-EP 1637344 B1	2009, 2
E002836	EE-EP 1898876 B1	2009, 2	E002893	EE-EP 1695902 B1	2009, 2
E002837	EE-EP 1513500 B1	2009, 2	E002894	EE-EP 1621468 B1	2009, 2
E002838	EE-EP 1492506 B1	2009, 2	E002895	EE-EP 1724202 B1	2009, 2
E002839	EE-EP 1680088 B1	2009, 2	E002896	EE-EP 1753674 B1	2009, 2
E002840	EE-EP 1515702 B1	2009, 2	E002897	EE-EP 1364890 B1	2009, 2
E002841	EE-EP 1613288 B1	2009, 2	E002898	EE-EP 1742858 B1	2009, 2
E002842	EE-EP 1635830 B1	2009, 2	E002899	EE-EP 1848655 B1	2009, 2
E002843	EE-EP 1608346 B1	2009, 2	E002900	EE-EP 1549585 B1	2009, 2
E002844	EE-EP 1667665 B1	2009, 2	E002901	EE-EP 1583719 B1	2009, 2
E002845	EE-EP 1615628 B1	2009, 2	E002902	EE-EP 1430000 B1	2009, 2
E002846	EE-EP 1663185 B1	2009, 2	E002903	EE-EP 1797021 B1	2009, 2
E002847	EE-EP 1505959 B1	2009, 2	E002904	EE-EP 1461306 B1	2009, 2
E002848	EE-EP 1799201 B1	2009, 2	E002905	EE-EP 1856035 B1	2009, 2
E002849	EE-EP 1666033 B1	2009, 2	E002906	EE-EP 1453798 B1	2009, 2
E002850	EE-EP 1768657 B1	2009, 2	E002907	EE-EP 1776340 B1	2009, 2
E002851	EE-EP 1423105 B1	2009, 2	E002908	EE-EP 1663970 B1	2009, 2
E002852	EE-EP 1613300 B1	2009, 2	E002909	EE-EP 1470107 B1	2009, 2
E002853	EE-EP 1824472 B1	2009, 2	E002910	EE-EP 1685105 B1	2009, 2
E002854	EE-EP 1646378 B1	2009, 2	E002911	EE-EP 1603877 B1	2009, 2
E002855	EE-EP 1863474 B1	2009, 2	E002912	EE-EP 1757586 B1	2009, 2
E002856	EE-EP 1703905 B1	2009, 2	E002913	EE-EP 1658269 B1	2009, 2
E002857	EE-EP 1824479 B1	2009, 2	E002914	EE-EP 1725536 B1	2009, 2
E002858	EE-EP 1708705 B1	2009, 2	E002915	EE-EP 1438296 B1	2009, 2
E002859	EE-EP 1539166 B1	2009, 2	E002916	EE-EP 1660462 B1	2009, 2
E002860	EE-EP 1531819 B1	2009, 2	E002917	EE-EP 1844029 B1	2009, 2
E002861	EE-EP 1646389 B1	2009, 2	E002918	EE-EP 1917254 B1	2009, 2
E002862	EE-EP 1750716 B1	2009, 2	E002919	EE-EP 1417196 B1	2009, 2
E002863	EE-EP 1553952 B1	2009, 2	E002920	EE-EP 1763520 B1	2009, 2
E002864	EE-EP 1478366 B1	2009, 2	E002921	EE-EP 1893597 B1	2009, 2
E002865	EE-EP 1509232 B1	2009, 2	E002922	EE-EP 1492785 B1	2009, 2
E002866	EE-EP 1818059 B1	2009, 2	E002923	EE-EP 1751131 B1	2009, 2
E002867	EE-EP 1474143 B1	2009, 2	E002924	EE-EP 1664016 B1	2009, 2
E002868	EE-EP 1575597 B1	2009, 2	E002925	EE-EP 1761515 B1	2009, 2
E002869	EE-EP 1742642 B1	2009, 2	E002926	EE-EP 1732918 B1	2009, 2
E002870	EE-EP 1455802 B1	2009, 2	E002927	EE-EP 1426371 B1	2009, 2
E002871	EE-EP 1677806 B1	2009, 2	E002928	EE-EP 1532138 B1	2009, 2
E002872	EE-EP 1411978 B1	2009, 2	E002929	EE-EP 1606282 B1	2009, 2

Registreeringu number	Patendikirjelduse tõlke number	Patendilehe number, kus avaldati Euroopa patendikirjelduse tõlke esitamise teade
-----------------------	--------------------------------	--

E002930	EE-EP 1408038 B1	2009, 2	E002987	EE-EP 1509660 B1	2009, 2
E002931	EE-EP 1874762 B1	2009, 2	E002988	EE-EP 1536077 B1	2009, 2
E002932	EE-EP 1805169 B1	2009, 2	E002989	EE-EP 1724409 B1	2009, 2
E002933	EE-EP 1638969 B1	2009, 2	E002990	EE-EP 1738044 B1	2009, 2
E002934	EE-EP 1753764 B1	2009, 2	E002991	EE-EP 1937919 B1	2009, 2
E002935	EE-EP 1636228 B1	2009, 2	E002992	EE-EP 1781896 B1	2009, 2
E002936	EE-EP 1841768 B1	2009, 2	E002993	EE-EP 1723307 B1	2009, 2
E002937	EE-EP 1549652 B1	2009, 2	E002994	EE-EP 1623112 B1	2009, 2
E002938	EE-EP 1668014 B1	2009, 2	E002995	EE-EP 1636498 B1	2009, 2
E002939	EE-EP 1883641 B1	2009, 2	E002996	EE-EP 1750020 B1	2009, 2
E002940	EE-EP 1603919 B1	2009, 2	E002997	EE-EP 1812743 B1	2009, 2
E002941	EE-EP 1907396 B1	2009, 2	E002998	EE-EP 1828697 B1	2009, 2
E002942	EE-EP 1554284 B1	2009, 2	E002999	EE-EP 1715283 B1	2009, 2
E002943	EE-EP 1598358 B1	2009, 2	E003000	EE-EP 1615014 B1	2009, 2
E002944	EE-EP 1745054 B1	2009, 2	E003001	EE-EP 1644737 B1	2009, 2
E002945	EE-EP 1543013 B1	2009, 2	E003002	EE-EP 1606621 B1	2009, 2
E002946	EE-EP 1711507 B1	2009, 2	E003003	EE-EP 1846874 B1	2009, 2
E002947	EE-EP 1799696 B1	2009, 2	E003004	EE-EP 1530771 B1	2009, 2
E002948	EE-EP 1791852 B1	2009, 2	E003005	EE-EP 1278173 B1	2009, 2
E002949	EE-EP 1599490 B1	2009, 2	E003006	EE-EP 1920497 B1	2009, 2
E002950	EE-EP 1523488 B1	2009, 2	E003007	EE-EP 1796215 B1	2009, 2
E002951	EE-EP 1888613 B1	2009, 2	E003008	EE-EP 1670110 B1	2009, 2
E002952	EE-EP 1532131 B1	2009, 2	E003009	EE-EP 1476959 B1	2009, 2
E002953	EE-EP 1805201 B1	2009, 2	E003010	EE-EP 1433305 B1	2009, 2
E002954	EE-EP 1776377 B1	2009, 2	E003011	EE-EP 1343324 B1	2009, 2
E002955	EE-EP 1594885 B1	2009, 2	E003012	EE-EP 1584212 B1	2009, 2
E002956	EE-EP 1833842 B1	2009, 2	E003013	EE-EP 1523238 B1	2009, 3
E002957	EE-EP 1734048 B1	2009, 2	E003014	EE-EP 1771070 B1	2009, 3
E002958	EE-EP 1753776 B1	2009, 2	E003015	EE-EP 1599096 B1	2009, 3
E002959	EE-EP 1437365 B1	2009, 2	E003016	EE-EP 1817961 B1	2009, 3
E002960	EE-EP 1465912 B1	2009, 2	E003017	EE-EP 1921924 B1	2009, 3
E002961	EE-EP 1701978 B1	2009, 2	E003018	EE-EP 1855551 B1	2009, 3
E002962	EE-EP 1752471 B1	2009, 2	E003019	EE-EP 1921935 B1	2009, 3
E002963	EE-EP 1639011 B1	2009, 2	E003020	EE-EP 1820425 B1	2009, 3
E002964	EE-EP 1789464 B1	2009, 2	E003021	EE-EP 1875838 B1	2009, 3
E002965	EE-EP 1902085 B1	2009, 2	E003022	EE-EP 1521540 B1	2009, 3
E002966	EE-EP 1854826 B1	2009, 2	E003023	EE-EP 1816935 B1	2009, 3
E002967	EE-EP 1836239 B1	2009, 2	E003024	EE-EP 1859712 B1	2009, 3
E002968	EE-EP 1915424 B1	2009, 2	E003025	EE-EP 1827185 B1	2009, 3
E002969	EE-EP 1877501 B1	2009, 2	E003026	EE-EP 1641389 B1	2009, 3
E002970	EE-EP 1633825 B1	2009, 2	E003027	EE-EP 1503668 B1	2009, 3
E002971	EE-EP 1794280 B1	2009, 2	E003028	EE-EP 1791472 B1	2009, 3
E002972	EE-EP 1633859 B1	2009, 2	E003029	EE-EP 1749486 B1	2009, 3
E002973	EE-EP 1608753 B1	2009, 2	E003030	EE-EP 1774916 B1	2009, 3
E002974	EE-EP 1409692 B1	2009, 2	E003031	EE-EP 1496815 B1	2009, 3
E002975	EE-EP 1525320 B1	2009, 2	E003032	EE-EP 1852090 B1	2009, 3
E002976	EE-EP 1833978 B1	2009, 2	E003033	EE-EP 1917936 B1	2009, 3
E002977	EE-EP 1567667 B1	2009, 2	E003034	EE-EP 1521572 B1	2009, 3
E002978	EE-EP 1662011 B1	2009, 2	E003035	EE-EP 1534237 B1	2009, 3
E002979	EE-EP 1856303 B1	2009, 2	E003036	EE-EP 1660034 B1	2009, 3
E002980	EE-EP 1449961 B1	2009, 2	E003037	EE-EP 1758555 B1	2009, 3
E002981	EE-EP 1846617 B1	2009, 2	E003038	EE-EP 1906921 B1	2009, 3
E002982	EE-EP 1964978 B1	2009, 2	E003039	EE-EP 1729730 B1	2009, 3
E002983	EE-EP 1752583 B1	2009, 2	E003040	EE-EP 1937221 B1	2009, 3
E002984	EE-EP 1525354 B1	2009, 2	E003041	EE-EP 1890681 B1	2009, 3
E002985	EE-EP 1405957 B1	2009, 2	E003042	EE-EP 1928431 B1	2009, 3
E002986	EE-EP 1754840 B1	2009, 2	E003043	EE-EP 1474117 B1	2009, 3

Registreeringu number	Patendikirjelduse tõlke number	Patendilehe number, kus avaldati Euroopa patendikirjelduse tõlke esitamise teade
-----------------------	--------------------------------	--

E003044	EE-EP 1425001 B1	2009, 3	E003101	EE-EP 1490312 B1	2009, 3
E003045	EE-EP 1754478 B1	2009, 3	E003102	EE-EP 1565422 B1	2009, 3
E003046	EE-EP 1592416 B1	2009, 3	E003103	EE-EP 1966118 B1	2009, 3
E003047	EE-EP 1569635 B1	2009, 3	E003104	EE-EP 1558560 B1	2009, 3
E003048	EE-EP 1448186 B1	2009, 3	E003105	EE-EP 1856031 B1	2009, 3
E003049	EE-EP 1807072 B1	2009, 3	E003106	EE-EP 1682493 B1	2009, 3
E003050	EE-EP 1458388 B1	2009, 3	E003107	EE-EP 1513806 B1	2009, 3
E003051	EE-EP 1885363 B1	2009, 3	E003108	EE-EP 1862455 B1	2009, 3
E003052	EE-EP 1855677 B1	2009, 3	E003109	EE-EP 1928821 B1	2009, 3
E003053	EE-EP 1719511 B1	2009, 3	E003110	EE-EP 1542968 B1	2009, 3
E003054	EE-EP 1608374 B1	2009, 3	E003111	EE-EP 1851198 B1	2009, 3
E003055	EE-EP 1663236 B1	2009, 3	E003112	EE-EP 1771415 B1	2009, 3
E003056	EE-EP 1663243 B1	2009, 3	E003113	EE-EP 1751106 B1	2009, 3
E003057	EE-EP 1845994 B1	2009, 3	E003114	EE-EP 1751105 B1	2009, 3
E003058	EE-EP 1787649 B1	2009, 3	E003115	EE-EP 1862458 B1	2009, 3
E003059	EE-EP 1635843 B1	2009, 3	E003116	EE-EP 1727801 B1	2009, 3
E003060	EE-EP 1652526 B1	2009, 3	E003117	EE-EP 1601653 B1	2009, 3
E003061	EE-EP 1663257 B1	2009, 3	E003118	EE-EP 1680405 B1	2009, 3
E003062	EE-EP 1877070 B1	2009, 3	E003119	EE-EP 1492773 B1	2009, 3
E003063	EE-EP 1658854 B1	2009, 3	E003120	EE-EP 1879869 B1	2009, 3
E003064	EE-EP 1829548 B1	2009, 3	E003121	EE-EP 1797042 B1	2009, 3
E003065	EE-EP 1776958 B1	2009, 3	E003122	EE-EP 1626964 B1	2009, 3
E003066	EE-EP 1429800 B1	2009, 3	E003123	EE-EP 1569916 B1	2009, 3
E003067	EE-EP 1386615 B1	2009, 3	E003124	EE-EP 1611111 B1	2009, 3
E003068	EE-EP 1434600 B1	2009, 3	E003125	EE-EP 1919883 B1	2009, 3
E003069	EE-EP 1599222 B1	2009, 3	E003126	EE-EP 1694658 B1	2009, 3
E003070	EE-EP 1765404 B1	2009, 3	E003127	EE-EP 1756084 B1	2009, 3
E003071	EE-EP 1682185 B1	2009, 3	E003128	EE-EP 1425277 B1	2009, 3
E003072	EE-EP 1782845 B1	2009, 3	E003129	EE-EP 1904477 B1	2009, 3
E003073	EE-EP 1559443 B1	2009, 3	E003130	EE-EP 1664026 B1	2009, 3
E003074	EE-EP 1920794 B1	2009, 3	E003131	EE-EP 1753757 B1	2009, 3
E003075	EE-EP 1832287 B1	2009, 3	E003132	EE-EP 1773829 B1	2009, 3
E003076	EE-EP 1416842 B1	2009, 3	E003133	EE-EP 1735304 B1	2009, 3
E003077	EE-EP 1463563 B1	2009, 3	E003134	EE-EP 1899333 B1	2009, 3
E003078	EE-EP 1913979 B1	2009, 3	E003135	EE-EP 1740584 B1	2009, 3
E003079	EE-EP 1476226 B1	2009, 3	E003136	EE-EP 1851217 B1	2009, 3
E003080	EE-EP 1913980 B1	2009, 3	E003137	EE-EP 1902054 B1	2009, 3
E003081	EE-EP 1807184 B1	2009, 3	E003138	EE-EP 1924580 B1	2009, 3
E003082	EE-EP 1658143 B1	2009, 3	E003139	EE-EP 1853601 B1	2009, 3
E003083	EE-EP 1719596 B1	2009, 3	E003140	EE-EP 1675852 B1	2009, 3
E003084	EE-EP 1792704 B1	2009, 3	E003141	EE-EP 1509523 B1	2009, 3
E003085	EE-EP 1727665 B1	2009, 3	E003142	EE-EP 1869049 B1	2009, 3
E003086	EE-EP 1834789 B1	2009, 3	E003143	EE-EP 1917267 B1	2009, 3
E003087	EE-EP 1765600 B1	2009, 3	E003144	EE-EP 1668017 B1	2009, 3
E003088	EE-EP 1492678 B1	2009, 3	E003145	EE-EP 1648905 B1	2009, 3
E003089	EE-EP 1710145 B1	2009, 3	E003146	EE-EP 1676847 B1	2009, 3
E003090	EE-EP 1340667 B1	2009, 3	E003147	EE-EP 1676848 B1	2009, 3
E003091	EE-EP 1478567 B1	2009, 3	E003148	EE-EP 1768988 B1	2009, 3
E003092	EE-EP 1414708 B1	2009, 3	E003149	EE-EP 1896489 B1	2009, 3
E003093	EE-EP 1939106 B1	2009, 3	E003150	EE-EP 1631574 B1	2009, 3
E003094	EE-EP 1714908 B1	2009, 3	E003151	EE-EP 1517915 B1	2009, 3
E003095	EE-EP 1910190 B1	2009, 3	E003152	EE-EP 1551868 B1	2009, 3
E003096	EE-EP 1636123 B1	2009, 3	E003153	EE-EP 1673391 B1	2009, 3
E003097	EE-EP 1893513 B1	2009, 3	E003154	EE-EP 1772465 B1	2009, 3
E003098	EE-EP 1890967 B1	2009, 3	E003155	EE-EP 1446425 B1	2009, 3
E003099	EE-EP 1584606 B1	2009, 3	E003156	EE-EP 1585770 B1	2009, 3
E003100	EE-EP 1517873 B1	2009, 3	E003157	EE-EP 1863851 B1	2009, 3

Registreeringu number	Patendikirjelduse tõlke number	Patendilehe number, kus avaldati Euroopa patendikirjelduse tõlke esitamise teade
-----------------------	--------------------------------	--

E003158	EE-EP 1791872 B1	2009, 3	E003215	EE-EP 1744647 B1	2009, 4
E003159	EE-EP 1571173 B1	2009, 3	E003216	EE-EP 1631175 B1	2009, 4
E003160	EE-EP 1784437 B1	2009, 3	E003217	EE-EP 1859714 B1	2009, 4
E003161	EE-EP 1641870 B1	2009, 3	E003218	EE-EP 1404244 B1	2009, 4
E003162	EE-EP 1790701 B1	2009, 3	E003219	EE-EP 1610726 B1	2009, 4
E003163	EE-EP 1717284 B1	2009, 3	E003220	EE-EP 1857077 B1	2009, 4
E003164	EE-EP 1627022 B1	2009, 3	E003221	EE-EP 1761236 B1	2009, 4
E003165	EE-EP 1733024 B1	2009, 3	E003222	EE-EP 1748756 B1	2009, 4
E003166	EE-EP 1751276 B1	2009, 3	E003223	EE-EP 1885336 B1	2009, 4
E003167	EE-EP 1805305 B1	2009, 3	E003224	EE-EP 1948131 B1	2009, 4
E003168	EE-EP 1805306 B1	2009, 3	E003225	EE-EP 1718258 B1	2009, 4
E003169	EE-EP 1805307 B1	2009, 3	E003226	EE-EP 1729732 B1	2009, 4
E003170	EE-EP 1468093 B1	2009, 3	E003227	EE-EP 1940366 B1	2009, 4
E003171	EE-EP 1572967 B1	2009, 3	E003228	EE-EP 1515704 B1	2009, 4
E003172	EE-EP 1662010 B1	2009, 3	E003229	EE-EP 1667666 B1	2009, 4
E003173	EE-EP 1817439 B1	2009, 3	E003230	EE-EP 1511472 B1	2009, 4
E003174	EE-EP 1458899 B1	2009, 3	E003231	EE-EP 1556020 B1	2009, 4
E003175	EE-EP 1556526 B1	2009, 3	E003232	EE-EP 1809267 B1	2009, 4
E003176	EE-EP 1799876 B1	2009, 3	E003233	EE-EP 1572180 B1	2009, 4
E003177	EE-EP 1633921 B1	2009, 3	E003234	EE-EP 1541197 B1	2009, 4
E003178	EE-EP 1600552 B1	2009, 3	E003235	EE-EP 1513519 B1	2009, 4
E003179	EE-EP 1536065 B1	2009, 3	E003236	EE-EP 1835907 B1	2009, 4
E003180	EE-EP 1749937 B1	2009, 3	E003237	EE-EP 1689391 B1	2009, 4
E003181	EE-EP 1910626 B1	2009, 3	E003238	EE-EP 1696913 B1	2009, 4
E003182	EE-EP 1786982 B1	2009, 3	E003239	EE-EP 1455785 B1	2009, 4
E003183	EE-EP 1643046 B1	2009, 3	E003240	EE-EP 1530469 B1	2009, 4
E003184	EE-EP 1555360 B1	2009, 3	E003241	EE-EP 1720550 B1	2009, 4
E003185	EE-EP 1430191 B1	2009, 3	E003242	EE-EP 1879580 B1	2009, 4
E003186	EE-EP 1486636 B1	2009, 3	E003243	EE-EP 1861100 B1	2009, 4
E003187	EE-EP 1623095 B1	2009, 3	E003244	EE-EP 1542668 B1	2009, 4
E003188	EE-EP 1529928 B1	2009, 3	E003245	EE-EP 1703909 B1	2009, 4
E003189	EE-EP 1911947 B1	2009, 3	E003246	EE-EP 1686997 B1	2009, 4
E003190	EE-EP 1639247 B1	2009, 3	E003247	EE-EP 1524981 B1	2009, 4
E003191	EE-EP 1636490 B1	2009, 3	E003248	EE-EP 1729777 B1	2009, 4
E003192	EE-EP 1760374 B1	2009, 3	E003249	EE-EP 1696931 B1	2009, 4
E003193	EE-EP 1896774 B1	2009, 3	E003250	EE-EP 1759702 B1	2009, 4
E003194	EE-EP 1596153 B1	2009, 3	E003251	EE-EP 1638582 B1	2009, 4
E003195	EE-EP 1531332 B1	2009, 3	E003252	EE-EP 1568356 B1	2009, 4
E003196	EE-EP 1776587 B1	2009, 3	E003253	EE-EP 1553959 B1	2009, 4
E003197	EE-EP 1792196 B1	2009, 3	E003254	EE-EP 1841439 B1	2009, 4
E003198	EE-EP 1733263 B1	2009, 3	E003255	EE-EP 1967198 B1	2009, 4
E003199	EE-EP 1907899 B1	2009, 3	E003256	EE-EP 1824504 B1	2009, 4
E003200	EE-EP 1657623 B1	2009, 3	E003257	EE-EP 1466617 B1	2009, 4
E003201	EE-EP 1396855 B1	2009, 3	E003258	EE-EP 1793859 B1	2009, 4
E003202	EE-EP 1797573 B1	2009, 3	E003259	EE-EP 1536827 B1	2009, 4
E003203	EE-EP 1506626 B1	2009, 3	E003260	EE-EP 1904099 B1	2009, 4
E003204	EE-EP 1564929 B1	2009, 3	E003261	EE-EP 1414494 B1	2009, 4
E003205	EE-EP 1650998 B1	2009, 3	E003262	EE-EP 1613350 B1	2009, 4
E003206	EE-EP 1827096 B1	2009, 4	E003263	EE-EP 1737488 B1	2009, 4
E003207	EE-EP 1778012 B1	2009, 4	E003264	EE-EP 1763368 B1	2009, 4
E003208	EE-EP 1931203 B1	2009, 4	E003265	EE-EP 1786400 B1	2009, 4
E003209	EE-EP 1733628 B1	2009, 4	E003266	EE-EP 1515752 B1	2009, 4
E003210	EE-EP 1559430 B1	2009, 4	E003267	EE-EP 1476201 B1	2009, 4
E003211	EE-EP 1841335 B1	2009, 4	E003268	EE-EP 1897569 B1	2009, 4
E003212	EE-EP 1585397 B1	2009, 4	E003269	EE-EP 1894583 B1	2009, 4
E003213	EE-EP 1893044 B1	2009, 4	E003270	EE-EP 1885413 B1	2009, 4
E003214	EE-EP 1632142 B1	2009, 4	E003271	EE-EP 1409045 B1	2009, 4

Registreeringu number	Patendikirjelduse tõlke number	Patendilehe number, kus avaldati Euroopa patendikirjelduse tõlke esitamise teade
-----------------------	--------------------------------	--

E003272	EE-EP 1736194 B1	2009, 4	E003329	EE-EP 1747220 B1	2009, 4
E003273	EE-EP 1545710 B1	2009, 4	E003330	EE-EP 1719773 B1	2009, 4
E003274	EE-EP 1629880 B1	2009, 4	E003331	EE-EP 1841765 B1	2009, 4
E003275	EE-EP 1530506 B1	2009, 4	E003332	EE-EP 1697379 B1	2009, 4
E003276	EE-EP 1554044 B1	2009, 4	E003333	EE-EP 1899354 B1	2009, 4
E003277	EE-EP 1810755 B1	2009, 4	E003334	EE-EP 1856132 B1	2009, 4
E003278	EE-EP 1937415 B1	2009, 4	E003335	EE-EP 1625135 B1	2009, 4
E003279	EE-EP 1968756 B1	2009, 4	E003336	EE-EP 1506222 B1	2009, 4
E003280	EE-EP 1404466 B1	2009, 4	E003337	EE-EP 1539808 B1	2009, 4
E003281	EE-EP 1772206 B1	2009, 4	E003338	EE-EP 1629007 B1	2009, 4
E003282	EE-EP 1753560 B1	2009, 4	E003339	EE-EP 1846445 B1	2009, 4
E003283	EE-EP 1761353 B1	2009, 4	E003340	EE-EP 1819729 B1	2009, 4
E003284	EE-EP 1526954 B1	2009, 4	E003341	EE-EP 1639007 B1	2009, 4
E003285	EE-EP 1991411 B1	2009, 4	E003342	EE-EP 1699826 B1	2009, 4
E003286	EE-EP 1480819 B1	2009, 4	E003343	EE-EP 1458763 B1	2009, 4
E003287	EE-EP 1794028 B1	2009, 4	E003344	EE-EP 1717257 B1	2009, 4
E003288	EE-EP 1472133 B1	2009, 4	E003345	EE-EP 1668095 B1	2009, 4
E003289	EE-EP 1937546 B1	2009, 4	E003346	EE-EP 1476539 B1	2009, 4
E003290	EE-EP 1626897 B1	2009, 4	E003347	EE-EP 1509600 B1	2009, 4
E003291	EE-EP 1888415 B1	2009, 4	E003348	EE-EP 1637610 B1	2009, 4
E003292	EE-EP 1778553 B1	2009, 4	E003349	EE-EP 1649079 B1	2009, 4
E003293	EE-EP 1917198 B1	2009, 4	E003350	EE-EP 1682721 B1	2009, 4
E003294	EE-EP 1669306 B1	2009, 4	E003351	EE-EP 1893811 B1	2009, 4
E003295	EE-EP 1663870 B1	2009, 4	E003352	EE-EP 1907629 B1	2009, 4
E003296	EE-EP 1904404 B1	2009, 4	E003353	EE-EP 1733100 B1	2009, 4
E003297	EE-EP 2011766 B1	2009, 4	E003354	EE-EP 1589156 B1	2009, 4
E003298	EE-EP 1631533 B1	2009, 4	E003355	EE-EP 1524385 B1	2009, 4
E003299	EE-EP 1805129 B1	2009, 4	E003356	EE-EP 1807583 B1	2009, 4
E003300	EE-EP 1472209 B1	2009, 4	E003357	EE-EP 1446545 B1	2009, 4
E003301	EE-EP 1836151 B1	2009, 4	E003358	EE-EP 1536171 B1	2009, 4
E003302	EE-EP 1660431 B1	2009, 4	E003359	EE-EP 1801499 B1	2009, 4
E003303	EE-EP 1633697 B1	2009, 4	E003360	EE-EP 1830134 B1	2009, 4
E003304	EE-EP 1446379 B1	2009, 4	E003361	EE-EP 1820022 B1	2009, 4
E003305	EE-EP 1687257 B1	2009, 4	E003362	EE-EP 1495330 B1	2009, 4
E003306	EE-EP 1465861 B1	2009, 4	E003363	EE-EP 1636593 B1	2009, 4
E003307	EE-EP 1603866 B1	2009, 4	E003364	EE-EP 1896868 B1	2009, 4
E003308	EE-EP 1554240 B1	2009, 4	E003365	EE-EP 1815300 B1	2009, 4
E003309	EE-EP 1656346 B1	2009, 4	E003366	EE-EP 1746556 B1	2009, 4
E003310	EE-EP 1885695 B1	2009, 4	E003367	EE-EP 1442443 B1	2009, 4
E003311	EE-EP 1558575 B1	2009, 4	E003368	EE-EP 1923976 B1	2009, 4
E003312	EE-EP 1567493 B1	2009, 4	E003369	EE-EP 1627489 B1	2009, 4
E003313	EE-EP 1771421 B1	2009, 4	E003370	EE-EP 1779663 B1	2009, 4
E003314	EE-EP 1711470 B1	2009, 4	E003371	EE-EP 1642494 B1	2009, 5
E003315	EE-EP 1789395 B1	2009, 4	E003372	EE-EP 1531668 B1	2009, 5
E003316	EE-EP 1670769 B1	2009, 4	E003373	EE-EP 1651040 B1	2009, 5
E003317	EE-EP 1663989 B1	2009, 4	E003374	EE-EP 1921918 B1	2009, 5
E003318	EE-EP 1673352 B1	2009, 4	E003375	EE-EP 1696728 B1	2009, 5
E003319	EE-EP 1456182 B1	2009, 4	E003376	EE-EP 1587368 B1	2009, 5
E003320	EE-EP 1673354 B1	2009, 4	E003377	EE-EP 1624756 B1	2009, 5
E003321	EE-EP 1664012 B1	2009, 4	E003378	EE-EP 1435204 B1	2009, 5
E003322	EE-EP 1427720 B1	2009, 4	E003379	EE-EP 1638408 B1	2009, 5
E003323	EE-EP 1641775 B1	2009, 4	E003380	EE-EP 1605780 B1	2009, 5
E003324	EE-EP 1620429 B1	2009, 4	E003381	EE-EP 1815755 B1	2009, 5
E003325	EE-EP 1765807 B1	2009, 4	E003382	EE-EP 1736065 B1	2009, 5
E003326	EE-EP 1660482 B1	2009, 4	E003383	EE-EP 1942753 B1	2009, 5
E003327	EE-EP 1419160 B1	2009, 4	E003384	EE-EP 1476033 B1	2009, 5
E003328	EE-EP 1555265 B1	2009, 4	E003385	EE-EP 1500341 B1	2009, 5

Registreeringu number	Patendikirjelduse tõlke number	Patendilehe number, kus avaldati Euroopa patendikirjelduse tõlke esitamise teade
-----------------------	--------------------------------	--

E003386	EE-EP 1432329 B1	2009, 5	E003443	EE-EP 1596998 B1	2009, 5
E003387	EE-EP 1967100 B1	2009, 5	E003444	EE-EP 1964621 B1	2009, 5
E003388	EE-EP 1853142 B1	2009, 5	E003445	EE-EP 1911534 B1	2009, 5
E003389	EE-EP 1611827 B1	2009, 5	E003446	EE-EP 1727632 B1	2009, 5
E003390	EE-EP 1891911 B1	2009, 5	E003447	EE-EP 1753566 B1	2009, 5
E003391	EE-EP 1973514 B1	2009, 5	E003448	EE-EP 1459833 B1	2009, 5
E003392	EE-EP 1888013 B1	2009, 5	E003449	EE-EP 1646477 B1	2009, 5
E003393	EE-EP 1673057 B1	2009, 5	E003450	EE-EP 1855848 B1	2009, 5
E003394	EE-EP 1711158 B1	2009, 5	E003451	EE-EP 1485238 B1	2009, 5
E003395	EE-EP 1889607 B1	2009, 5	E003452	EE-EP 1968779 B1	2009, 5
E003396	EE-EP 1843749 B1	2009, 5	E003453	EE-EP 1626886 B1	2009, 5
E003397	EE-EP 1420759 B1	2009, 5	E003454	EE-EP 1798139 B1	2009, 5
E003398	EE-EP 1578350 B1	2009, 5	E003455	EE-EP 1487692 B1	2009, 5
E003399	EE-EP 1551763 B1	2009, 5	E003456	EE-EP 1792826 B1	2009, 5
E003400	EE-EP 1861073 B1	2009, 5	E003457	EE-EP 1698553 B1	2009, 5
E003401	EE-EP 1965768 B1	2009, 5	E003458	EE-EP 1954566 B1	2009, 5
E003402	EE-EP 1556013 B1	2009, 5	E003459	EE-EP 1687209 B1	2009, 5
E003403	EE-EP 1740154 B1	2009, 5	E003460	EE-EP 1757527 B1	2009, 5
E003404	EE-EP 1638539 B1	2009, 5	E003461	EE-EP 1533244 B1	2009, 5
E003405	EE-EP 1758565 B1	2009, 5	E003462	EE-EP 1601582 B1	2009, 5
E003406	EE-EP 1808168 B1	2009, 5	E003463	EE-EP 1478579 B1	2009, 5
E003407	EE-EP 1608350 B1	2009, 5	E003464	EE-EP 1784344 B1	2009, 5
E003408	EE-EP 1613296 B1	2009, 5	E003465	EE-EP 1533252 B1	2009, 5
E003409	EE-EP 1556026 B1	2009, 5	E003466	EE-EP 1736421 B1	2009, 5
E003410	EE-EP 1485080 B1	2009, 5	E003467	EE-EP 1764348 B1	2009, 5
E003411	EE-EP 1408954 B1	2009, 5	E003468	EE-EP 1712526 B1	2009, 5
E003412	EE-EP 1667678 B1	2009, 5	E003469	EE-EP 1485329 B1	2009, 5
E003413	EE-EP 1507529 B1	2009, 5	E003470	EE-EP 1871722 B1	2009, 5
E003414	EE-EP 1414451 B1	2009, 5	E003471	EE-EP 1678103 B1	2009, 5
E003415	EE-EP 1513528 B1	2009, 5	E003472	EE-EP 1849762 B1	2009, 5
E003416	EE-EP 1680105 B1	2009, 5	E003473	EE-EP 1814840 B1	2009, 5
E003417	EE-EP 1423115 B1	2009, 5	E003474	EE-EP 1881956 B1	2009, 5
E003418	EE-EP 1691808 B1	2009, 5	E003475	EE-EP 1511718 B1	2009, 5
E003419	EE-EP 1624871 B1	2009, 5	E003476	EE-EP 1519915 B1	2009, 5
E003420	EE-EP 1686999 B1	2009, 5	E003477	EE-EP 1861365 B1	2009, 5
E003421	EE-EP 1888077 B1	2009, 5	E003478	EE-EP 1678135 B1	2009, 5
E003422	EE-EP 1562603 B1	2009, 5	E003479	EE-EP 1689720 B1	2009, 5
E003423	EE-EP 1519731 B1	2009, 5	E003480	EE-EP 1786790 B1	2009, 5
E003424	EE-EP 1416937 B1	2009, 5	E003481	EE-EP 1828154 B1	2009, 5
E003425	EE-EP 1721612 B1	2009, 5	E003482	EE-EP 1511740 B1	2009, 5
E003426	EE-EP 1581235 B1	2009, 5	E003483	EE-EP 1599461 B1	2009, 5
E003427	EE-EP 1835922 B1	2009, 5	E003484	EE-EP 1656365 B1	2009, 5
E003428	EE-EP 1874341 B1	2009, 5	E003485	EE-EP 1648878 B1	2009, 5
E003429	EE-EP 1673106 B1	2009, 5	E003486	EE-EP 1828166 B1	2009, 5
E003430	EE-EP 1827500 B1	2009, 5	E003487	EE-EP 1963304 B1	2009, 5
E003431	EE-EP 1862185 B1	2009, 5	E003488	EE-EP 1867644 B1	2009, 5
E003432	EE-EP 1542740 B1	2009, 5	E003489	EE-EP 1981874 B1	2009, 5
E003433	EE-EP 1569708 B1	2009, 5	E003490	EE-EP 1725544 B1	2009, 5
E003434	EE-EP 1913978 B1	2009, 5	E003491	EE-EP 1776358 B1	2009, 5
E003435	EE-EP 1941932 B1	2009, 5	E003492	EE-EP 1445258 B1	2009, 5
E003436	EE-EP 1786531 B1	2009, 5	E003493	EE-EP 1934207 B1	2009, 5
E003437	EE-EP 1499410 B1	2009, 5	E003494	EE-EP 1740583 B1	2009, 5
E003438	EE-EP 1965879 B1	2009, 5	E003495	EE-EP 1601673 B1	2009, 5
E003439	EE-EP 1945339 B1	2009, 5	E003496	EE-EP 1713805 B1	2009, 5
E003440	EE-EP 1877173 B1	2009, 5	E003497	EE-EP 1838710 B1	2009, 5
E003441	EE-EP 1572367 B1	2009, 5	E003498	EE-EP 1758905 B1	2009, 5
E003442	EE-EP 1277527 B1	2009, 5	E003499	EE-EP 1718649 B1	2009, 5

Registreeringu number	Patendikirjelduse tõlke number	Patendilehe number, kus avaldati Euroopa patendikirjelduse tõlke esitamise teade
-----------------------	--------------------------------	--

E003500	EE-EP 1608653 B1	2009, 5	E003557	EE-EP 1589823 B1	2009, 6
E003501	EE-EP 1861405 B1	2009, 5	E003558	EE-EP 1868445 B1	2009, 6
E003502	EE-EP 1622912 B1	2009, 5	E003559	EE-EP 1959765 B1	2009, 6
E003503	EE-EP 1725566 B1	2009, 5	E003560	EE-EP 1427300 B1	2009, 6
E003504	EE-EP 1704154 B1	2009, 5	E003561	EE-EP 1906775 B1	2009, 6
E003505	EE-EP 1789427 B1	2009, 5	E003562	EE-EP 1991092 B1	2009, 6
E003506	EE-EP 1572711 B1	2009, 5	E003563	EE-EP 1854386 B1	2009, 6
E003507	EE-EP 1546185 B1	2009, 5	E003564	EE-EP 1685813 B1	2009, 6
E003508	EE-EP 1468014 B1	2009, 5	E003565	EE-EP 1605876 B1	2009, 6
E003509	EE-EP 1831252 B1	2009, 5	E003566	EE-EP 1465602 B1	2009, 6
E003510	EE-EP 1781697 B1	2009, 5	E003567	EE-EP 1987817 B1	2009, 6
E003511	EE-EP 1548032 B1	2009, 5	E003568	EE-EP 1729753 B1	2009, 6
E003512	EE-EP 1817345 B1	2009, 5	E003569	EE-EP 1414428 B1	2009, 6
E003513	EE-EP 1899394 B1	2009, 5	E003570	EE-EP 1797876 B1	2009, 6
E003514	EE-EP 1917286 B1	2009, 5	E003571	EE-EP 1485087 B1	2009, 6
E003515	EE-EP 1891200 B1	2009, 5	E003572	EE-EP 1682121 B1	2009, 6
E003516	EE-EP 1803820 B1	2009, 5	E003573	EE-EP 1835912 B1	2009, 6
E003517	EE-EP 1654387 B1	2009, 5	E003574	EE-EP 1877052 B1	2009, 6
E003518	EE-EP 1576195 B1	2009, 5	E003575	EE-EP 1503756 B1	2009, 6
E003519	EE-EP 1354968 B1	2009, 5	E003576	EE-EP 1896019 B1	2009, 6
E003520	EE-EP 1917370 B1	2009, 5	E003577	EE-EP 1919474 B1	2009, 6
E003521	EE-EP 1920079 B1	2009, 5	E003578	EE-EP 1750704 B1	2009, 6
E003522	EE-EP 1969159 B1	2009, 5	E003579	EE-EP 2007384 B1	2009, 6
E003523	EE-EP 1637631 B1	2009, 5	E003580	EE-EP 1753431 B1	2009, 6
E003524	EE-EP 1306471 B1	2009, 5	E003581	EE-EP 1861105 B1	2009, 6
E003525	EE-EP 1371762 B1	2009, 5	E003582	EE-EP 1727550 B1	2009, 6
E003526	EE-EP 2050850 B1	2009, 5	E003583	EE-EP 1771178 B1	2009, 6
E003527	EE-EP 1967631 B1	2009, 5	E003584	EE-EP 1684770 B1	2009, 6
E003528	EE-EP 1713976 B1	2009, 5	E003585	EE-EP 1978981 B1	2009, 6
E003529	EE-EP 1590537 B1	2009, 5	E003586	EE-EP 1620116 B1	2009, 6
E003530	EE-EP 1873325 B1	2009, 5	E003587	EE-EP 1663287 B1	2009, 6
E003531	EE-EP 1705312 B1	2009, 5	E003588	EE-EP 1623719 B1	2009, 6
E003532	EE-EP 1597448 B1	2009, 5	E003589	EE-EP 1715893 B1	2009, 6
E003533	EE-EP 1702124 B1	2009, 5	E003590	EE-EP 1802347 B1	2009, 6
E003534	EE-EP 1689958 B1	2009, 5	E003591	EE-EP 1671661 B1	2009, 6
E003535	EE-EP 1718829 B1	2009, 5	E003592	EE-EP 1745806 B1	2009, 6
E003536	EE-EP 1925795 B1	2009, 5	E003593	EE-EP 1839689 B1	2009, 6
E003537	EE-EP 1623115 B1	2009, 5	E003594	EE-EP 1527795 B1	2009, 6
E003538	EE-EP 1952021 B1	2009, 5	E003595	EE-EP 1913967 B1	2009, 6
E003539	EE-EP 1990566 B1	2009, 5	E003596	EE-EP 1509266 B1	2009, 6
E003540	EE-EP 1728023 B1	2009, 5	E003597	EE-EP 1633422 B1	2009, 6
E003541	EE-EP 1848918 B1	2009, 5	E003598	EE-EP 1838396 B1	2009, 6
E003542	EE-EP 1462755 B1	2009, 5	E003599	EE-EP 1967262 B1	2009, 6
E003543	EE-EP 1438607 B1	2009, 5	E003600	EE-EP 1663505 B1	2009, 6
E003544	EE-EP 1719070 B1	2009, 5	E003601	EE-EP 1812176 B1	2009, 6
E003545	EE-EP 1469429 B1	2009, 5	E003602	EE-EP 1827739 B1	2009, 6
E003546	EE-EP 1474809 B1	2009, 5	E003603	EE-EP 1648654 B1	2009, 6
E003547	EE-EP 1845649 B1	2009, 5	E003604	EE-EP 1877226 B1	2009, 6
E003548	EE-EP 1530861 B1	2009, 5	E003605	EE-EP 1699609 B1	2009, 6
E003549	EE-EP 1955513 B1	2009, 5	E003606	EE-EP 1793978 B1	2009, 6
E003550	EE-EP 1452059 B1	2009, 5	E003607	EE-EP 1449645 B1	2009, 6
E003551	EE-EP 1566983 B1	2009, 5	E003608	EE-EP 1872959 B1	2009, 6
E003552	EE-EP 1856965 B1	2009, 6	E003609	EE-EP 1371502 B1	2009, 6
E003553	EE-EP 1962572 B1	2009, 6	E003610	EE-EP 1555141 B1	2009, 6
E003554	EE-EP 1486111 B1	2009, 6	E003611	EE-EP 1827873 B1	2009, 6
E003555	EE-EP 1677600 B1	2009, 6	E003612	EE-EP 1798068 B1	2009, 6
E003556	EE-EP 1509085 B1	2009, 6	E003613	EE-EP 1740440 B1	2009, 6

Registreeringu number	Patendikirjelduse tõlke number	Patendilehe number, kus avaldati Euroopa patendikirjelduse tõlke esitamise teade
-----------------------	--------------------------------	--

E003614	EE-EP 1714895 B1	2009, 6	E003670	EE-EP 1622926 B1	2009, 6
E003615	EE-EP 1786694 B1	2009, 6	E003671	EE-EP 1831240 B1	2009, 6
E003616	EE-EP 1740484 B1	2009, 6	E003672	EE-EP 1675579 B1	2009, 6
E003617	EE-EP 1915301 B1	2009, 6	E003673	EE-EP 1597274 B1	2009, 6
E003618	EE-EP 1948537 B1	2009, 6	E003674	EE-EP 1760089 B1	2009, 6
E003619	EE-EP 1558513 B1	2009, 6	E003675	EE-EP 1651668 B1	2009, 6
E003620	EE-EP 1636139 B1	2009, 6	E003676	EE-EP 1752470 B1	2009, 6
E003621	EE-EP 1501774 B1	2009, 6	E003677	EE-EP 1648934 B1	2009, 6
E003622	EE-EP 1840125 B1	2009, 6	E003678	EE-EP 1735345 B1	2009, 6
E003623	EE-EP 1940772 B1	2009, 6	E003679	EE-EP 1655308 B1	2009, 6
E003624	EE-EP 1406858 B1	2009, 6	E003680	EE-EP 1706424 B1	2009, 6
E003625	EE-EP 1492761 B1	2009, 6	E003681	EE-EP 1711530 B1	2009, 6
E003626	EE-EP 1558565 B1	2009, 6	E003682	EE-EP 1527100 B1	2009, 6
E003627	EE-EP 1871738 B1	2009, 6	E003683	EE-EP 1654286 B1	2009, 6
E003628	EE-EP 1611088 B1	2009, 6	E003684	EE-EP 1606318 B1	2009, 6
E003629	EE-EP 1462442 B1	2009, 6	E003685	EE-EP 1620470 B1	2009, 6
E003630	EE-EP 1667964 B1	2009, 6	E003686	EE-EP 2009042 B1	2009, 6
E003631	EE-EP 1471054 B1	2009, 6	E003687	EE-EP 1697454 B1	2009, 6
E003632	EE-EP 1776339 B1	2009, 6	E003688	EE-EP 1629057 B1	2009, 6
E003633	EE-EP 1861367 B1	2009, 6	E003689	EE-EP 1976960 B1	2009, 6
E003634	EE-EP 1979321 B1	2009, 6	E003690	EE-EP 1636348 B1	2009, 6
E003635	EE-EP 1599450 B1	2009, 6	E003691	EE-EP 1597359 B1	2009, 6
E003636	EE-EP 1633719 B1	2009, 6	E003692	EE-EP 1432793 B1	2009, 6
E003637	EE-EP 1924560 B1	2009, 6	E003693	EE-EP 1578949 B1	2009, 6
E003638	EE-EP 1670768 B1	2009, 6	E003694	EE-EP 1805312 B1	2009, 6
E003639	EE-EP 1926712 B1	2009, 6	E003695	EE-EP 1745136 B1	2009, 6
E003640	EE-EP 1701944 B1	2009, 6	E003696	EE-EP 1745140 B1	2009, 6
E003641	EE-EP 1483247 B1	2009, 6	E003697	EE-EP 1529116 B1	2009, 6
E003642	EE-EP 1546119 B1	2009, 6	E003698	EE-EP 1598475 B1	2009, 6
E003643	EE-EP 1937662 B1	2009, 6	E003699	EE-EP 1612330 B1	2009, 6
E003644	EE-EP 1644350 B1	2009, 6	E003700	EE-EP 1777346 B1	2009, 6
E003645	EE-EP 1732917 B1	2009, 6	E003701	EE-EP 1951963 B1	2009, 6
E003646	EE-EP 1757601 B1	2009, 6	E003702	EE-EP 1818458 B1	2009, 6
E003647	EE-EP 1899322 B1	2009, 6	E003703	EE-EP 1571265 B1	2009, 6
E003648	EE-EP 1928858 B1	2009, 6	E003704	EE-EP 1979552 B1	2009, 6
E003649	EE-EP 1856102 B1	2009, 6	E003705	EE-EP 1809833 B1	2009, 6
E003650	EE-EP 1847539 B1	2009, 6	E003706	EE-EP 1691005 B1	2009, 6
E003651	EE-EP 1592686 B1	2009, 6	E003707	EE-EP 1440215 B1	2009, 6
E003652	EE-EP 1753748 B1	2009, 6	E003708	EE-EP 1344881 B1	2009, 6
E003653	EE-EP 1844039 B1	2009, 6	E003709	EE-EP 1630332 B1	2009, 6
E003654	EE-EP 1678166 B1	2009, 6	E003710	EE-EP 1630337 B1	2009, 6
E003655	EE-EP 1989200 B1	2009, 6	E003711	EE-EP 1476659 B1	2009, 6
E003656	EE-EP 1756096 B1	2009, 6	E003712	EE-EP 1606538 B1	2009, 6
E003657	EE-EP 1857457 B1	2009, 6	E003713	EE-EP 1927806 B1	2009, 6
E003658	EE-EP 1987026 B1	2009, 6	E003714	EE-EP 1724522 B1	2009, 6
E003659	EE-EP 1427415 B1	2009, 6	E003715	EE-EP 1963755 B1	2009, 6
E003660	EE-EP 1877409 B1	2009, 6	E003716	EE-EP 1955055 B1	2009, 6
E003661	EE-EP 1603910 B1	2009, 6	E003717	EE-EP 2030039 B1	2009, 6
E003662	EE-EP 1789419 B1	2009, 6	E003718	EE-EP 1749264 B1	2009, 6
E003663	EE-EP 1699797 B1	2009, 6	E003719	EE-EP 1744326 B1	2009, 6
E003664	EE-EP 1740591 B1	2009, 6	E003720	EE-EP 1701421 B1	2009, 6
E003665	EE-EP 1874781 B1	2009, 6	E003721	EE-EP 1897196 B1	2009, 6
E003666	EE-EP 1910381 B1	2009, 6	E003722	EE-EP 1836778 B1	2009, 6
E003667	EE-EP 1660507 B1	2009, 6	E003723	EE-EP 1688000 B1	2009, 6
E003668	EE-EP 1904511 B1	2009, 6	E003724	EE-EP 1847149 B1	2009, 6
E003669	EE-EP 1633771 B1	2009, 6	E003725	EE-EP 1652408 B1	2009, 6

**FG4A. EESTIS KEHTIVATE EUROOPA PATENTIDE
PATENDIOMANIKE TÄHESTIKULINE LOEND**

Patendiomanik	Registreeringu number	Patendilehe number, kus avaldati Euroopa patendikirjelduse tõlke esitamise teade			
4 AZA IP NV	E003136	2009, 3	Alcon, Inc.	E003269	2009, 4
4SC AG	E003477	2009, 5	Alcon, Inc.	E003462	2009, 5
Abbott Cardiovascular Systems Inc.	E003432	2009, 5	Alcon, Inc.	E003593	2009, 6
Abbott Spine	E002829	2009, 2	Alcon Research, Ltd.	E003220	2009, 4
ABBOTT LABORATORIES	E002843	2009, 2	Alcon Research, Ltd.	E003390	2009, 5
ABBOTT LABORATORIES	E002913	2009, 2	ALCON INC.	E002615	2009, 1
ABBOTT LABORATORIES	E002972	2009, 2	ALFA WASSERMANN S.p.A.	E002836	2009, 2
ABBOTT LABORATORIES	E003145	2009, 3	ALFA WASSERMANN S.p.A.	E003146	2009, 3
Abgenix, Inc.	E003682	2009, 6	ALFA WASSERMANN S.p.A.	E003147	2009, 3
Abloy Oy	E003533	2009, 5	ALLERGAN, INC.	E003071	2009, 3
Abloy Oy	E003534	2009, 5	Alpintechnik AG	E002996	2009, 2
Acadia Pharmaceuticals Inc.	E002704	2009, 1	Alpvision S.A.	E003010	2009, 2
Acadia Pharmaceuticals Inc.	E003249	2009, 4	ALSTOM BELGIUM S.A.	E002683	2009, 1
Actelion Pharmaceuticals Ltd.	E002723	2009, 1	Amarin Neuroscience Limited	E002977	2009, 2
Actelion Pharmaceuticals Ltd.	E002855	2009, 2	Amrona AG	E002882	2009, 2
ACTIAL Farmaceutica Lda.	E002764	2009, 1	Amrona AG	E003078	2009, 3
Actimis Pharmaceuticals, Inc.,	E003499	2009, 5	Amrona AG	E003080	2009, 3
ADC GMBH	E002802	2009, 1	Amrona AG	E003434	2009, 5
ADCOCK INGRAM LIMITED	E002864	2009, 2	Amrona AG	E003435	2009, 5
Addex Pharma SA	E002910	2009, 2	Amrona AG	E003598	2009, 6
Addex Pharma SA	E002911	2009, 2	Antisense Pharma GmbH	E003062	2009, 3
Advance Holdings Limited	E002616	2009, 1	Anton Debatin GmbH Werk für		
Advanced Plasma Power Limited	E003193	2009, 3	werbende Verpackung	E003292	2009, 4
AE&E Austria GmbH & Co KG	E003274	2009, 4	Apogenix GmbH	E003684	2009, 6
Affymax, Inc.	E003338	2009, 4	Applied Molecular Evolution, Inc.	E003680	2009, 6
Akzo Nobel Coatings International B.V.	E002970	2009, 2	Araclón Biotech, S. L.	E003588	2009, 6
Akzo Nobel Coatings International BV	E002964	2009, 2	ARCELOR France	E002777	2009, 1
Akzo Nobel Coatings International BV	E002969	2009, 2	ArcelorMittal France	E002791	2009, 1
Akzo Nobel Coatings International BV	E003164	2009, 3	Arena Pharmaceuticals, Inc.	E002709	2009, 1
Akzo Nobel Coatings International BV	E003688	2009, 6	Arena Pharmaceuticals, Inc.	E002929	2009, 2
Albis Plastic GmbH	E003198	2009, 3	Arena Pharmaceuticals, Inc.	E003127	2009, 3
Albis Plastic GmbH	E003541	2009, 5	Arena Pharmaceuticals, Inc.	E003405	2009, 5
Alcan Technology & Management Ltd.	E003085	2009, 3	Arena Pharmaceuticals, Inc.	E003406	2009, 5
Alcan Technology & Management Ltd.	E003607	2009, 6	ARES TRADING S.A.	E003073	2009, 3
ALCAN RHENALU	E003287	2009, 4	ARES TRADING S.A.	E003270	2009, 4
Alcon, Inc.	E002610	2009, 1	Arexis AB	E002763	2009, 1
Alcon, Inc.	E002630	2009, 1	Argenta Discovery Limited	E003057	2009, 3
Alcon, Inc.	E002832	2009, 2	ARKEMA FRANCE	E003159	2009, 3
Alcon, Inc.	E002868	2009, 2	Array Biopharma, Inc.	E002729	2009, 1
Alcon, Inc.	E002878	2009, 2	Arrow Therapeutics Limited	E003582	2009, 6
Alcon, Inc.	E002879	2009, 2	Artweger GmbH & Co.	E003389	2009, 5
Alcon, Inc.	E003032	2009, 3	ARVEDI, Giovanni	E002675	2009, 1
Alcon, Inc.	E003033	2009, 3	ARVEDI, Giovanni	E002978	2009, 2
Alcon, Inc.	E003034	2009, 3	ARVEDI, Giovanni	E003172	2009, 3
Alcon, Inc.	E003077	2009, 3	Arzneimittel GmbH Apotheker		
Alcon, Inc.	E003223	2009, 4	Vetter & Co. Ravensburg	E003594	2009, 6
			Asat AG Applied Science & Technology	E002671	2009, 1
			Ashland Licensing and Intellectual Property LLC	E003282	2009, 4
			Assa OEM AB	E003535	2009, 5
			AstraZeneca AB	E002623	2009, 1
			AstraZeneca AB	E002643	2009, 1

Patendiomanik	Registreeringu number	Patendilehe number, kus avaldati Euroopa patendikirjelduse tõlke esitamise teade		
AstraZeneca AB	E002667	2009, 1	BAUSTOFFWERKE GEBHART	
AstraZeneca AB	E002713	2009, 1	& SOHNE GMBH & CO. KG	E003605 2009, 6
AstraZeneca AB	E002905	2009, 2	Bavarian Nordic A/S	E002751 2009, 1
AstraZeneca AB	E002922	2009, 2	Bayer Animal Health GmbH	E002837 2009, 2
AstraZeneca AB	E002945	2009, 2	Bayer Animal Health GmbH	E003376 2009, 5
AstraZeneca AB	E003043	2009, 3	Bayer Animal Health GmbH	E003377 2009, 5
AstraZeneca AB	E003055	2009, 3	Bayer Animal Health GmbH	E003573 2009, 6
AstraZeneca AB	E003107	2009, 3	Bayer CropScience AG	E002592 2009, 1
AstraZeneca AB	E003122	2009, 3	Bayer CropScience AG	E003373 2009, 5
AstraZeneca AB	E003273	2009, 4	Bayer CropScience AG	E003694 2009, 6
AstraZeneca AB	E003302	2009, 4	Bayer CropScience	
AstraZeneca AB	E003309	2009, 4	Aktiengesellschaft	E003555 2009, 6
AstraZeneca AB	E003316	2009, 4	Bayer HealthCare, LLC	E002881 2009, 2
AstraZeneca AB	E003319	2009, 4	Bayer Innovation GmbH	E002660 2009, 1
AstraZeneca AB	E003420	2009, 5	Bayer MaterialScience AG	E003163 2009, 3
AstraZeneca AB	E003486	2009, 5	Bayer MaterialScience AG	E003344 2009, 4
AstraZeneca AB	E003495	2009, 5	Bayer Schering Pharma AG	E003421 2009, 5
AstraZeneca AB	E003580	2009, 6	Bayer Schering Pharma	
AstraZeneca AB	E003642	2009, 6	Aktiengesellschaft	E002760 2009, 1
AstraZeneca AB	E003650	2009, 6	Bayer Schering Pharma	
AstraZeneca UK Limited	E003317	2009, 4	Aktiengesellschaft	E002937 2009, 2
Atlas Copco Rock Drills AB	E003187	2009, 3	Bayer Schering Pharma	
Auriga International S.A.	E002613	2009, 1	Aktiengesellschaft	E003002 2009, 2
Auris Medical AG	E003568	2009, 6	Bayer Schering Pharma	
AVANIR PHARMACEUTICALS	E002859	2009, 2	Aktiengesellschaft	E003058 2009, 3
Aventis Pharma S.A.	E003111	2009, 3	Bayer Schering Pharma	
Aventis Pharma S.A.	E003126	2009, 3	Aktiengesellschaft	E003059 2009, 3
Aventis Pharma S.A.	E003256	2009, 4	Bayer Schering Pharma	
Aventis Pharma S.A.	E003479	2009, 5	Aktiengesellschaft	E003067 2009, 3
Aventis Pharma S.A.	E003660	2009, 6	Bayer Schering Pharma	
Aventis Pharma S.A.	E003670	2009, 6	Aktiengesellschaft	E003222 2009, 4
Aventis Pharmaceuticals Inc.	E003329	2009, 4	Bayer Schering Pharma	
Aventis Pharmaceuticals Inc.	E003478	2009, 5	Aktiengesellschaft	E003239 2009, 4
Axikin Pharmaceuticals, Inc.	E003054	2009, 3	Bayer Schering Pharma	
Ayton Patent AG	E002784	2009, 1	Aktiengesellschaft	E003300 2009, 4
Aziende Chimiche Riunite Angelini			Bayer Schering Pharma	
Francesco A.C.R.A.F. S.p.A.	E002620	2009, 1	Aktiengesellschaft	E003318 2009, 4
Æterna Zentaris GmbH	E002702	2009, 1	Bayer Schering Pharma	
Æterna Zentaris GmbH	E002767	2009, 1	Aktiengesellschaft	E003653 2009, 6
B+F Baumaschinen u. Factoring AG	E003291	2009, 4	Bayer Schering Pharma	
BASF Agro B.V.	E003104	2009, 3	Aktiengesellschaft	E003658 2009, 6
BASF Construction Polymers GmbH	E002965	2009, 2	BCDE Group Waste Management Ltd Oy	E002901 2009, 2
BASF CORPORATION	E002598	2009, 1	Becker Marine Systems GmbH & Co. KG	E003290 2009, 4
BASF SE	E002594	2009, 1	Bekaert Advanced Coatings	E002979 2009, 2
BASF SE	E002598	2009, 1	Bekaert Advanced Coatings	E003176 2009, 3
BASF SE	E002815	2009, 2	BENTLE PRODUCTS AG	E003553 2009, 6
BASF SE	E002816	2009, 2	Beres, Jozsef	E003026 2009, 3
BASF SE	E002818	2009, 2	Berlanga Acosta, Jorge	E003257 2009, 4
BASF SE	E003013	2009, 3	BERLIN-CHEMIE AG	E002852 2009, 2
BASF SE	E003206	2009, 4	BERRY FINANCE NV	E003083 2009, 3
BASF SE	E003375	2009, 5	BERRY FINANCE NV	E003610 2009, 6
BASF SE	E003438	2009, 5	Best Partners Worldwide Limited	E002603 2009, 1
BAUER Maschinen GmbH	E002774	2009, 1	Best Partners Worldwide Limited	E003382 2009, 5
BAUER Maschinen GmbH	E002983	2009, 2	Bial-Portela & CA, S.A.	E003315 2009, 4
			BIAL - Portela & Ca., S.A.	E002930 2009, 2

Patendiomanik	Registreeringu number	Patendilehe number, kus avaldati Euroopa patendikirjelduse tõlke esitamise teade			
Bifodan A/S	E002758	2009, 1	Borst, Terence	E002992	2009, 2
Big Drum S.L.	E002680	2009, 1	BRAINTREE LABORATORIES,		
Billon, Michel	E003704	2009, 6	INC.	E003061	2009, 3
Bio Minerals N.V.	E003399	2009, 5	Bristol-Myers Squibb Company	E002741	2009, 1
Bio3Research Srl.	E003583	2009, 6	Bristol-Myers Squibb Company	E002746	2009, 1
BioAlliance Pharma	E002835	2009, 2	Bristol-Myers Squibb Company	E002948	2009, 2
Biocon Limited	E003298	2009, 4	Bristol-Myers Squibb Company	E003244	2009, 4
Biodel, Inc.	E003403	2009, 5	Bristol-Myers Squibb Company	E003306	2009, 4
Bioferme OY	E002601	2009, 1	Bristol-Myers Squibb Company	E003578	2009, 6
Biogen Idec MA Inc.	E002654	2009, 1	Bristol-Myers Squibb Company	E003659	2009, 6
Biolex Therapeutics, Inc.	E003396	2009, 5	Bristol-Myers Squibb Company	E003663	2009, 6
Biolux OY	E002601	2009, 1	Brizio, Adriana	E002608	2009, 1
Biomet Deutschland GmbH	E002661	2009, 1	Brogi, Lorianò	E003554	2009, 6
Bionest Technologies Inc.	E002902	2009, 2	Bühler AG	E003558	2009, 6
Bioplax Limited	E003251	2009, 4	Bühler Bindler GmbH	E003557	2009, 6
Biotempt B.V.	E002651	2009, 1	Bundesdruckerei GmbH	E002798	2009, 1
Biotest AG	E003683	2009, 6	CABOT CORPORATION	E003175	2009, 3
BIRKEN GMBH	E003037	2009, 3	CADILA HEALTHCARE		
BJÖRKBODA LAS OY AB	E003708	2009, 6	LIMITED	E003119	2009, 3
Blasticon Biotechnologische			CADILA HEALTHCARE		
Forschung GmbH	E002759	2009, 1	LIMITED	E003123	2009, 3
Bluestar Silicones France	E003161	2009, 3	CADILA HEALTHCARE		
Bluestar Silicones France SAS	E003687	2009, 6	LIMITED	E003307	2009, 4
BNB CONCEPT SA	E003365	2009, 4	Calypso Wireless, Inc.	E002806	2009, 1
BOARD OF SUPERVISORS OF			Cambridge Biotechnology Ltd	E003426	2009, 5
LOUISIANA STATE			Cambridge Laboratories (Ireland)		
UNIVERSITY AND			Limited	E002733	2009, 1
AGRICULTURAL AND			Cambridge Laboratories (Ireland)		
MECHANICAL COLLEGE	E002872	2009, 2	Limited	E003051	2009, 3
Boehringer Ingelheim International			Cambridge Laboratories (Ireland)		
GmbH	E002727	2009, 1	Limited	E003052	2009, 3
Boehringer Ingelheim International			Cambridge Laboratories (Ireland)		
GmbH	E003236	2009, 4	Limited	E003243	2009, 4
Boehringer Ingelheim International			Camilleri, Michel	E003082	2009, 3
GmbH	E003326	2009, 4	Canan-Haden Frias, Leonardo	E003257	2009, 4
Boehringer Ingelheim International			Cancer Research Technology		
GmbH	E003498	2009, 5	Limited	E002851	2009, 2
Boehringer Ingelheim International			Cancer Research Technology		
GmbH	E003596	2009, 6	Limited	E002919	2009, 2
BOEHRINGER INGELHEIM			Carl Freudenberg KG	E003526	2009, 5
INTERNATIONAL GMBH	E003645	2009, 6	Carl Freudenberg KG	E003527	2009, 5
Boehringer Ingelheim			CELGENE CORPORATION	E003571	2009, 6
International GmbH	E003665	2009, 6	Cellzome Limited	E003299	2009, 4
Boehringer Ingelheim Pharma			Cellzome Limited	E003472	2009, 5
GmbH & Co. KG	E003361	2009, 4	CeloNova BioSciences Germany		
Boehringer Ingelheim Pharma			GmbH	E002662	2009, 1
GmbH & Co. KG	E003422	2009, 5	Centocor Ortho Biotech Inc.	E003672	2009, 6
Boehringer Ingelheim Pharma			Centre National d'Etudes Spatiales		
GmbH & Co. KG	E002622	2009, 1	(C.N.E.S.)	E003722	2009, 6
Boehringer Ingelheim			Centre National d'Etudes Spatiales	E003717	2009, 6
Pharmaceuticals Inc.	E003490	2009, 5	CENTRE NATIONAL DE LA		
Boehringer Ingelheim Vetmedica			RECHERCHE SCIENTIFIQUE		
GmbH	E002863	2009, 2	(CNRS)	E003416	2009, 5
Boehringer Ingelheim Vetmedica			CENTRE NATIONAL DE LA		
GmbH	E003166	2009, 3	RECHERCHE SCIENTIFIQUE		
Boehringer Ingelheim Vetmedica			(CNRS)	E003321	2009, 4
GmbH	E003337	2009, 4			

Patendiomanik	Registreeringu number	Patendilehe number, kus avaldati Euroopa patendikirjelduse tõlke esitamise teade		
CENTRO DE INGENIERIA			DELLNER COUPLERS AB	E003453 2009, 5
GENETICA Y BIOTECNOLOGIA	E003257	2009, 4	Demolition and Recycling	
CENTRO DE INGENIERIA			Equipment B.V.	E003703 2009, 6
GENETICA Y BIOTECNOLOGIA	E003567	2009, 6	Dental Vision BVBA	E003218 2009, 4
CEPHALON, INC.	E002700	2009, 1	Deutsche Amphibolin-Werke von	
CEPHALON, INC.	E002903	2009, 2	Robert Murjahn Stiftung & Co KG	E002755 2009, 1
CEPHALON, INC.	E003409	2009, 5	Deutsche Amphibolin-Werke von	
CEPHALON, INC.	E003667	2009, 6	Robert Murjahn Stiftung & Co KG	E003183 2009, 3
Chacon Corvea, Larissa	E003257	2009, 4	Deutsche Post AG	E003004 2009, 2
CHANTIERS DE			DEUTSCHE SISI-WERKE GmbH	
L' ATLANTIQUE	E003452	2009, 5	& Co. Betriebs KG	E002685 2009, 1
CHEMAGIS LTD.	E002730	2009, 1	Deutsches Krebsforschungszentrum	
Cheminova A/S	E003208	2009, 4	Stiftung des öffentlichen Rechts	E003684 2009, 6
Cheminova A/S	E003374	2009, 5	Diamond Power International Inc.	E003192 2009, 3
Chen, Chih-Chieh	E003189	2009, 3	Dipl. Ing. Thonhauser GmbH	E002757 2009, 1
Chen, Yung-Ching	E003189	2009, 3	Divapharma Chur AG	E003064 2009, 3
CHIESI FARMACEUTICI S.p.A.	E002695	2009, 1	DNP CANADA INC.	E002870 2009, 2
Chinoin Gyógyszer és Vegyészeti			Domantis Limited	E002963 2009, 2
Termékek Gyára Zrt.	E002719	2009, 1	Dompé S.P.A.	E002697 2009, 1
Chryso	E003470	2009, 5	DOMPE` pha.r.ma S.p.A.	E003105 2009, 3
CINVENTION AG	E002663	2009, 1	Dosenbach-Ochsner AG Schuhe	
CINVENTION AG	E002967	2009, 2	und Sport	E003385 2009, 5
Cipla Ltd.	E003423	2009, 5	Dow Corning Corporation	E003101 2009, 3
Coley Pharmaceutical GmbH	E002876	2009, 2	Dr. Willmar Schwabe GmbH &	
Coley Pharmaceutical Group, Inc.	E003053	2009, 3	Co. KG	E002920 2009, 2
Compass Marine Developments			Dreamwell, Ltd.	E002823 2009, 2
Limited	E003288	2009, 4	Dredging International	E003182 2009, 3
CONSEJO SUPERIOR DE			E.C.A.S. SRL	E003522 2009, 5
INVESTIGACIONES			E.I. DU PONT DE NEMOURS	
CIENTIFICAS	E002761	2009, 1	AND COMPANY	E002726 2009, 1
Construction Research and			E.I. DU PONT DE NEMOURS	
Technology GmbH	E003513	2009, 5	AND COMPANY	E003014 2009, 3
CONSTRUCTIONS INDUSTRIELLES			E.I. DU PONT DE NEMOURS	
DE LA MEDITERRANEE- CNIM	E003352	2009, 4	AND COMPANY	E003207 2009, 4
Contura A/S	E002828	2009, 2	EASTMAN CHEMICAL	
Cook Composites & Polymers			COMPANY	E003599 2009, 6
Company	E003514	2009, 5	Ecologia Environmental Solutions	
Corcept Therapeutics, Inc.	E002647	2009, 1	Ltd	E003443 2009, 5
CORIXA CORPORATION	E003508	2009, 5	ECOTEC S.r.l.	E003280 2009, 4
Cosmedical APS	E003393	2009, 5	Effect Ships International AS	E003455 2009, 5
Cosmo Technologies Ltd	E002621	2009, 1	Egis Gyógyszergyár Nyilvánosan	
CP Kelco APS	E003343	2009, 4	Működő Részvénytársaság	E003042 2009, 3
Creabilis Therapeutics S.P.A.	E003583	2009, 6	EGIS Gyógyszergyár Nyrt	E003113 2009, 3
CRUCIBLE MATERIALS			EGIS Gyógyszergyár Nyrt	E003114 2009, 3
CORPORATION	E003521	2009, 5	EGIS Gyógyszergyár Nyrt	E003632 2009, 6
Cullen, Mark	E003345	2009, 4	EGIS GYÓGYSZERGYÁR RT.	E002916 2009, 2
CV THERAPEUTICS, INC.	E002738	2009, 1	Eisai Corporation of North America	E003483 2009, 5
CycloMedia Technology B.V.	E002799	2009, 1	Eisai R&D Management Co., Ltd.	E002636 2009, 1
Daiichi Sankyo Company, Limited	E003631	2009, 6	Eisai R&D Management Co., Ltd.	E003328 2009, 4
DAKU Kunststoff GmbH	E003713	2009, 6	ELI LILLY AND COMPANY	E002724 2009, 1
DCA Design International Limited	E002665	2009, 1	ELI LILLY AND COMPANY	E002743 2009, 1
DCA Design International Limited	E002666	2009, 1	ELI LILLY AND COMPANY	E002814 2009, 2
DCA Design International Limited	E002880	2009, 2	ELI LILLY AND COMPANY	E002921 2009, 2
DCT Double-Cone Technology AG	E002995	2009, 2	ELI LILLY AND COMPANY	E002932 2009, 2
De Luca, Maria	E003149	2009, 3	ELI LILLY AND COMPANY	E003049 2009, 3
DEBIO RECHERCHE			ELI LILLY AND COMPANY	E003102 2009, 3
PHARMACEUTIQUE S.A.	E002614	2009, 1	ELI LILLY AND COMPANY	E003142 2009, 3

Patendiomanik	Registreeringu number	Patendilehe number, kus avaldati Euroopa patendikirjelduse tõlke esitamise teade
ELI LILLY AND COMPANY	E003151	2009, 3
ELI LILLY AND COMPANY	E003301	2009, 4
ELI LILLY AND COMPANY	E003476	2009, 5
ELI LILLY AND COMPANY	E003480	2009, 5
ELI LILLY AND COMPANY	E003482	2009, 5
ELI LILLY AND COMPANY	E003496	2009, 5
ELI LILLY AND COMPANY	E003509	2009, 5
ELI LILLY AND COMPANY	E003576	2009, 6
ELI LILLY AND COMPANY	E003637	2009, 6
ELI LILLY AND COMPANY	E003638	2009, 6
ELI LILLY AND COMPANY	E003639	2009, 6
ELI LILLY AND COMPANY	E003655	2009, 6
Elisa Oyj	E003367	2009, 4
Encrypta Gmbh	E003045	2009, 3
ENI S.p.A.	E003280	2009, 4
EntreMed, Inc.	E003417	2009, 5
Erytech Pharma	E003428	2009, 5
ESTEVE QUIMICA, S.A.	E002728	2009, 1
ESTEVE QUIMICA, S.A.	E003325	2009, 4
Etablissements MAGYAR	E003000	2009, 2
ETABLISSEMENTS PIERRE GREHAL ET COMPAGNIE SA	E003450	2009, 5
ETHICON ENDO-SURGERY, INC.	E003029	2009, 3
ETHICON ENDO-SURGERY, INC.	E003030	2009, 3
ETHICON ENDO-SURGERY, INC.	E003272	2009, 4
ETHICON INC.	E002831	2009, 2
ETHYPHARM	E003229	2009, 4
EURO-CELTIQUE S.A.	E002740	2009, 1
EURO-CELTIQUE S.A.	E002838	2009, 2
EURO-CELTIQUE S.A.	E002924	2009, 2
EURO-CELTIQUE S.A.	E003039	2009, 3
EURO-CELTIQUE S.A.	E003076	2009, 3
EURO-CELTIQUE S.A.	E003115	2009, 3
EURO-CELTIQUE S.A.	E003116	2009, 3
EURO-CELTIQUE S.A.	E003141	2009, 3
EURO-CELTIQUE S.A.	E003225	2009, 4
EURO-CELTIQUE S.A.	E003240	2009, 4
EURO-CELTIQUE S.A.	E003323	2009, 4
EURO-CELTIQUE S.A.	E003398	2009, 5
EURO-CELTIQUE S.A.	E003414	2009, 5
EURO-CELTIQUE S.A.	E003485	2009, 5
EURO-CELTIQUE S.A.	E003488	2009, 5
EURO-CELTIQUE S.A.	E003501	2009, 5
EURO-CELTIQUE S.A.	E003641	2009, 6
Eurokeg B.V.	E003466	2009, 5
EUROPEAN SPACE AGENCY	E003197	2009, 3
Evonik Degussa GmbH	E003528	2009, 5
EVR Medical S.à.r.l	E003031	2009, 3
f-star Biotechnologische Forschungs- und Entwicklungsges.m.b.H.	E002962	2009, 2
f-star Biotechnologische Forschungs- und Entwicklungsges.m.b.H.	E003154	2009, 3
f-star Biotechnologische Forschungs- und Entwicklungsges.m.b.H.	E003342	2009, 4
F. Hoffmann-La Roche AG	E002609	2009, 1
F. Hoffmann-La Roche AG	E002714	2009, 1
F. Hoffmann-La Roche AG	E002926	2009, 2
F. Hoffmann-La Roche AG	E003129	2009, 3
F. Hoffmann-La Roche AG	E003245	2009, 4
F. Hoffmann-La Roche AG	E003314	2009, 4
F. Hoffmann-La Roche AG	E003475	2009, 5
F. Hoffmann-La Roche AG	E003481	2009, 5
F. Hoffmann-La Roche AG	E003506	2009, 5
F.HOFFMANN-LA ROCHE AG	E002703	2009, 1
F.HOFFMANN-LA ROCHE AG	E002795	2009, 1
F.HOFFMANN-LA ROCHE AG	E003121	2009, 3
F.HOFFMANN-LA ROCHE AG	E003656	2009, 6
FABRICA NACIONAL DE MONEDA Y TIMBRE - REAL		
CASA DE LA MONEDA	E003005	2009, 2
FAIVELEY TRANSPORT	E002786	2009, 1
Fazekas, Gábor	E002896	2009, 2
Fernandez Montequin, Jos I.	E003257	2009, 4
FIDIA FARMACEUTICI S.p.A.	E003392	2009, 5
Flettner, Marc	E003620	2009, 6
FLSMIDTH Koch GmbH	E003618	2009, 6
Food Technology Noord-Oost Nederland B.V.	E003216	2009, 4
Fournier Laboratories Ireland Limited	E003623	2009, 6
Franco Perez, Neobalis	E003257	2009, 4
Fränkische Rohrwerke Gebr.		
Kirchner GmbH + Co KG	E003358	2009, 4
Fрати, Dante	E003608	2009, 6
Fraunhofer-Gesellschaft zur Förderung der angewandten Forschung e.V.	E003165	2009, 3
Fraunhofer-Gesellschaft zur Förderung der angewandten Forschung e.V.	E003018	2009, 3
Fraunhofer-Gesellschaft zur Förderung der angewandten Forschung e.V.	E003157	2009, 3
Freeglass GmbH & Co. Kg	E002679	2009, 1
Fresenius Kabi Deutschland GmbH	E002611	2009, 1
Fresenius Kabi Deutschland GmbH	E002753	2009, 1
Fritz Egger GmbH & Co.	E002889	2009, 2
Fritz Schäfer GmbH	E003460	2009, 5
Fritz Schäfer GmbH	E003461	2009, 5
Gala Industries, Inc.	E002890	2009, 2
Galderma S.A.	E002918	2009, 2
GALDERMA RESEARCH & DEVELOPMENT	E002627	2009, 1
GALDERMA RESEARCH & DEVELOPMENT	E003148	2009, 3
GALDERMA RESEARCH & DEVELOPMENT	E003410	2009, 5
Gas Turbine Efficiency AB	E003600	2009, 6
GEA Westfalia Separator GmbH	E003371	2009, 5
Gebr. Meijer St. Jabik B.V.	E002686	2009, 1
GEBR. WILLACH GmbH	E003020	2009, 3
Genentech, Inc.	E003262	2009, 4
Genentech, Inc.	E003363	2009, 4
Genentech, Inc.	E003692	2009, 6

Patendiomanik	Registreeringu number	Patendilehe number, kus avaldati Euroopa patendikirjelduse tõlke esitamise teade			
Genfarma Laboratorio S.L.	E003395	2009, 5	H.C. Starck Ltd.	E003447	2009, 5
Genomic Health, Inc.	E002765	2009, 1	Hakemann, Fritz	E002991	2009, 2
George, Susan, R.	E003362	2009, 4	Hanser, Volker Werner	E003202	2009, 3
Georgia-Pacific France	E003096	2009, 3	Hawle Armaturen GmbH	E003539	2009, 5
Georgia-Pacific France	E003097	2009, 3	HeliosAquaPlus Technology AG	E003431	2009, 5
Geronimo Perez, Haydee	E003257	2009, 4	Helmholtz-Zentrum für		
GILEAD SCIENCES, INC.	E002869	2009, 2	Umweltforschung GmbH - UFZ	E003443	2009, 5
GILEAD SCIENCES, INC.	E003041	2009, 3	Helsinn Healthcare S.A.	E002641	2009, 1
GILEAD SCIENCES, INC.	E003331	2009, 4	Helsinn Healthcare S.A.	E003227	2009, 4
Giuliani International Limited	E002973	2009, 2	Henningsson, Stefan	E003185	2009, 3
Giuliani S.p.A.	E003621	2009, 6	Heraeus Kulzer GmbH	E003072	2009, 3
Glaxo Group Limited	E003128	2009, 3	Heraeus Kulzer GmbH	E003591	2009, 6
GLAXO GROUP LIMITED	E002725	2009, 1	Heraeus Kulzer GmbH	E003592	2009, 6
GLAXO GROUP LIMITED	E002732	2009, 1	Herm. Friedr. Künne GmbH & Co.	E003184	2009, 3
GLAXO GROUP LIMITED	E002883	2009, 2	Herm. Friedr. Künne GmbH & Co.	E003531	2009, 5
GLAXO GROUP LIMITED	E002908	2009, 2	Hermann Gutmann Werke AG	E003186	2009, 3
GLAXO GROUP LIMITED	E002934	2009, 2	Herrera Martinez, Luis	E003257	2009, 4
GLAXO GROUP LIMITED	E003044	2009, 3	Herrmann, Klaus	E003188	2009, 3
GLAXO GROUP LIMITED	E003056	2009, 3	Hertwich Engineering GmbH	E002768	2009, 1
GLAXO GROUP LIMITED	E003247	2009, 4	Hesco Bastion Limited	E003701	2009, 6
GLAXO GROUP LIMITED	E003335	2009, 4	Hexion Specialty Chemicals Oy	E002756	2009, 1
GLAXO GROUP LIMITED	E003681	2009, 6	Himmelfreundpointer, Kurt	E003439	2009, 5
GlaxoSmithKline Consumer Healthcare GmbH & Co.KG.	E003386	2009, 5	Holt, Corneliu	E002789	2009, 1
GlaxoSmithKline istrazivacki centar Zagreb d.o.o.	E003669	2009, 6	Hunter-Fleming Limited	E003424	2009, 5
Glenmark Pharmaceuticals S.A.	E003324	2009, 4	Hybrigenics	E003675	2009, 6
Glycotape GmbH	E003156	2009, 3	Hydralift - BLM	E002899	2009, 2
Gmundner Fertigteile Gesellschaft m.b.H. & Co. KG.	E002981	2009, 2	I-CES	E003370	2009, 4
Gnosis S.p.A.	E003516	2009, 5	I.C.F. Industria Chimica Fine S.r.l.	E003394	2009, 5
GO SCIENCE LIMITED	E003289	2009, 4	IAT 21 Innovative Aeronautics Technologies GmbH	E002684	2009, 1
Gótzty, András	E002606	2009, 1	Ice-World International B.V.	E003542	2009, 5
Grünenthal GmbH	E002731	2009, 1	IDENIX Pharmaceuticals, Inc.	E002947	2009, 2
Grünenthal GmbH	E002840	2009, 2	Idex ASA	E003027	2009, 3
Grünenthal GmbH	E003131	2009, 3	iGUZZINI ILLUMINAZIONE S.p.A.	E003714	2009, 6
Grünenthal GmbH	E003303	2009, 4	Illyés, Miklos	E003026	2009, 3
Grünenthal GmbH	E003332	2009, 4	Ilypsa, Inc.	E002966	2009, 2
Grünenthal GmbH	E003474	2009, 5	Ilypsa, Inc.	E003686	2009, 6
Grünenthal GmbH	E003624	2009, 6	Immatics Biotechnologies GmbH	E002749	2009, 1
Grünenthal GmbH	E003666	2009, 6	Immatics Biotechnologies GmbH	E002750	2009, 1
GTX, Inc.	E002849	2009, 2	Immatics Biotechnologies GmbH	E002957	2009, 2
Guarino, Joseph	E003082	2009, 3	Immatics Biotechnologies GmbH	E003674	2009, 6
Guillen Nieto, Gerardo E.	E003257	2009, 4	Impress Group B.V.	E002894	2009, 2
H. Lundbeck A/S	E003510	2009, 5	Inca Solution Co., Ltd.	E003200	2009, 3
H. LUNDBECK A/S	E002637	2009, 1	INDAG Gesellschaft für		
H. LUNDBECK A/S	E002699	2009, 1	Industriebedarf mbH & Co.		
H. LUNDBECK A/S	E002744	2009, 1	Betriebs KG	E002690	2009, 1
H. LUNDBECK A/S	E002865	2009, 2	INDAG Gesellschaft für Industriebedarf		
H. LUNDBECK A/S	E003112	2009, 3	mbH & Co. Betriebs KG	E002691	2009, 1
H.C. Starck GmbH	E002943	2009, 2	INDAG Gesellschaft für Industriebedarf		
H.C. Starck GmbH	E003098	2009, 3	mbH & Co. Betriebs KG	E003457	2009, 5
H.C. Starck GmbH	E003295	2009, 4	Indena S.p.A.	E003255	2009, 4
H.C. Starck GmbH	E003447	2009, 5	Indena S.p.A.	E003696	2009, 6
H.C. Starck GmbH	E003519	2009, 5	INDENA S.p.A.	E002649	2009, 1
H.C. Starck GmbH	E003602	2009, 6	INDENA S.p.A.	E003063	2009, 3
H.C. Starck Inc.	E003283	2009, 4	INDENA S.p.A.	E003150	2009, 3
			INDENA S.p.A.	E003210	2009, 4

Patendiomanik	Registreeringu number	Patendilehe number, kus avaldati Euroopa patendikirjelduse tõlke esitamise teade			
INDENA S.p.A.	E003254	2009, 4	Kebony ASA	E003284	2009, 4
INDENA S.p.A.	E003570	2009, 6	Kekkilä Oyj	E002813	2009, 2
INDENA S.p.A.	E003581	2009, 6	KLEIN IBÉRICA, S.A.	E003709	2009, 6
Indevus Pharmaceuticals, Inc.	E003036	2009, 3	KLEIN IBÉRICA, S.A.	E003710	2009, 6
Indivumed GmbH	E003196	2009, 3	Knauf Gips KG	E003356	2009, 4
Innova Environnement	E002672	2009, 1	Knecht, Wolfgang	E003347	2009, 4
Institut Français du Pétrole	E002884	2009, 2	Kone Oyj (Kone Corporation)	E003619	2009, 6
Institut National de la Santé et de la Recherche Medicale	E002670	2009, 1	Kowa Company, Ltd.	E002866	2009, 2
INSTITUT NATIONAL DE LA SANTE ET DE LA RECHERCHE MEDICALE (INSERM)	E003568	2009, 6	Kraft Foods Global Brands LLC	E003209	2009, 4
Inter IKEA Systems B.V.	E003458	2009, 5	Kraft Foods Global Brands LLC	E003378	2009, 5
Inter IKEA Systems B.V.	E003616	2009, 6	Kraft Foods R & D, Inc.	E003093	2009, 3
Intercept Pharmaceuticals, Inc.	E002954	2009, 2	Kraft Foods R & D, Inc.	E003614	2009, 6
Interglarion Limited	E002678	2009, 1	Krause Maschinenbau GmbH	E003276	2009, 4
Interglarion Limited	E003179	2009, 3	Krka Tovarna Zdravil, D.D.,		
Interglarion Limited	E003705	2009, 6	Novo Mesto	E003415	2009, 5
Invento Spolka Z O.O.	E003459	2009, 5	KRKA, tovarna zdravil, d.d.,		
Iprotex GmbH & Co. KG	E003525	2009, 5	Novo mesto	E002834	2009, 2
ISTITUTO NAZIONALE PER LO STUDIO E LA CURA DEI TUMORI	E002958	2009, 2	Kufner Textilwerke GmbH	E002771	2009, 1
ISTITUTO NAZIONALE PER LO STUDIO E LA CURA DEI TUMORI	E002742	2009, 1	KUNDO SYSTEMTECHNIK GmbH	E003366	2009, 4
ISTITUTO NAZIONALE PER LO STUDIO E LA CURA DEI TUMORI	E002940	2009, 2	KXO AG	E003087	2009, 3
ITALFARMACO S.p.A.	E003569	2009, 6	L. MOLteni & C. DEI FRATELLI ALITTI SOCIETA` DI ESERCIZIO S.P.A	E002939	2009, 2
Janssen Pharmaceutica, N.V.	E003075	2009, 3	Laboratoire de Contactologie Appliquée - LCA	E003219	2009, 4
Janssen Pharmaceutica N.V.	E003489	2009, 5	LABORATOIRE THERAMEX	E003644	2009, 6
Janssen Pharmaceutica NV	E002701	2009, 1	Laboratoires Serono SA	E002670	2009, 1
Janssen Pharmaceutica NV	E002720	2009, 1	Laboratoires Serono SA	E003068	2009, 3
Janssen Pharmaceutica NV	E002923	2009, 2	LABORATOIRES BESINS INTERNATIONAL	E002848	2009, 2
Janssen Pharmaceutica NV	E002938	2009, 2	LABORATOIRES FOURNIER S.A.	E003310	2009, 4
Janssen Pharmaceutica NV	E003140	2009, 3	LABORATOIRES FOURNIER SA	E003577	2009, 6
Janssen Pharmaceutica NV	E003308	2009, 4	LABORATOIRES GOEMAR S.A.	E003584	2009, 6
Janssen Pharmaceutica NV	E003491	2009, 5	Laboratori Guidotti S.P.A.	E003232	2009, 4
Janssen Pharmaceutica NV	E003630	2009, 6	Laboratorios Almirall, S.A.	E002874	2009, 2
Janssen Pharmaceutica NV	E003636	2009, 6	Laboratorios Almirall, S.A.	E003070	2009, 3
Japan Tobacco, Inc.	E003330	2009, 4	Laboratorios Almirall, S.A.	E003264	2009, 4
Jetboil, Inc.	E003022	2009, 3	LACER, S.A.	E003144	2009, 3
Jimenez Bayardo, Arturo	E003250	2009, 4	Lafarge Platres S.A.	E003469	2009, 5
Jokey Plastik Gummersbach GmbH	E002895	2009, 2	LAINIERE DE PICARDIE BC	E003178	2009, 3
Jokey Plastik Gummersbach GmbH	E003092	2009, 3	Legal and Consulting Agency "JUREPROMCONSULTING" Ltd	E003174	2009, 3
Jörg von Seggern Maschinenbau GmbH	E003090	2009, 3	Lemken GmbH & Co. KG	E003552	2009, 6
Josef Möbius Bau-Aktiengesellschaft	E002982	2009, 2	Les Laboratoires Servier	E002624	2009, 1
JURA ELEKTROAPPARATE AG	E003025	2009, 3	Les Laboratoires Servier	E002625	2009, 1
JURA ELEKTROAPPARATE AG	E003563	2009, 6	Les Laboratoires Servier	E002644	2009, 1
K.U. LEUVEN RESEARCH & DEVELOPMENT	E003331	2009, 4	Les Laboratoires Servier	E002698	2009, 1
KAINDL FLOORING GmbH	E002781	2009, 1	Les Laboratoires Servier	E002706	2009, 1
Kämpf, Gerhard	E002805	2009, 1	Les Laboratoires Servier	E002708	2009, 1
KCI Licensing, Inc.	E003268	2009, 4	Les Laboratoires Servier	E002722	2009, 1
			Les Laboratoires Servier	E002912	2009, 2
			Les Laboratoires Servier	E002917	2009, 2
			Les Laboratoires Servier	E003228	2009, 4
			Les Laboratoires Servier	E003633	2009, 6
			Les Laboratoires Servier	E003634	2009, 6

Patendiomanik	Registreeringu number	Patendilehe number, kus avaldati Euroopa patendikirjelduse tõlke esitamise teade			
Les Laboratoires Servier	E003675	2009, 6	MILLENNIUM		
LG Life Sciences Limited	E002673	2009, 1	PHARMACEUTICALS, INC.	E003640	2009, 6
LG Life Sciences Ltd.	E002638	2009, 1	MILLENNIUM		
LG Life Sciences Ltd.	E002736	2009, 1	PHARMACEUTICALS, INC.	E003678	2009, 6
Lifescan Scotland Ltd	E002794	2009, 1	Millisecond Technologies Corp.	E003211	2009, 4
LifeScan, Inc.	E002762	2009, 1	Ming-Te, Chen	E003214	2009, 4
Linde AG	E003440	2009, 5	Mitsubishi Tanabe Pharma Corporation	E002705	2009, 1
Linde Aktiengesellschaft	E003016	2009, 3	Mitsubishi Tanabe Pharma Corporation	E002841	2009, 2
Lonza Biologics plc.	E002975	2009, 2	Mitsubishi Tanabe Pharma Corporation	E003322	2009, 4
LONZA, INC.	E003349	2009, 4	Mitsubishi Tanabe Pharma Corporation	E003500	2009, 5
Lowe Alpine Holdings Limited	E002605	2009, 1	Mitsubishi Tanabe Pharma Corporation	E003661	2009, 6
Lowe Alpine Holdings Limited	E003215	2009, 4	Mitsubishi Tanabe Pharma Corporation	E002867	2009, 2
LTS LOHMANN Therapie-Systeme AG	E002845	2009, 2	Mitsubishi Tanabe Pharma Corporation	E003712	2009, 6
Lumon Invest Oy	E003357	2009, 4	Mitsubishi Tanabe Pharma Corporation	E003094	2009, 3
LYTTRON Technology GmbH	E002811	2009, 1	Modular Properties Ltd	E002990	2009, 2
MAKHTESHIM CHEMICAL WORKS LIMITED	E002593	2009, 1	Mokveld Valves B.V.	E003194	2009, 3
Marutian, Sergey Vasilievich	E003174	2009, 3	Mondi AG	E003347	2009, 4
MAX-PLANCK-GESELLSCHAFT ZUR FÖRDERUNG DER WISSENSCHAFTEN E.V.	E003261	2009, 4	Mul-T-Lock Technologies Ltd.	E002600	2009, 1
Maximov, Vladimir Vladimirovich	E003523	2009, 5	Müller, Lothar	E003381	2009, 5
Mayex USA Kft.	E002688	2009, 1	Munch-Petersen, Birgitte	E003425	2009, 5
McLaurin, Joanne	E003407	2009, 5	N.V. Nutricia	E002639	2009, 1
McNeil AB	E003050	2009, 3	N.V. Nutricia	E002640	2009, 1
MEDAREX, INC.	E002655	2009, 1	N.V. Organon	E002953	2009, 2
MediGene AG	E003048	2009, 3	N.V. Organon	E003060	2009, 3
Medion Diagnostics GmbH	E003001	2009, 2	N.V. Organon	E003138	2009, 3
Menarini Ricerche S.p.A.	E002852	2009, 2	N.V. Organon	E003139	2009, 3
Menerga GmbH	E003360	2009, 4	N.V. Organon	E003143	2009, 3
Merck & Co., Inc. (a New Jersey corp.)	E003419	2009, 5	N.V. Organon	E003242	2009, 4
Merck & Co., Inc.	E002715	2009, 1	N.V. Organon	E003248	2009, 4
Merck & Co., Inc.	E002933	2009, 2	N.V. Organon	E003484	2009, 5
Merck & Co., Inc.	E003130	2009, 3	N.V. Organon	E003487	2009, 5
Merck & Co., Inc.	E003230	2009, 4	Nagraid SA	E003003	2009, 2
Merck & Co., Inc.	E003429	2009, 5	Nagravision SA	E003369	2009, 4
Merck Eprova AG	E003421	2009, 5	Nanobiotix	E002659	2009, 1
Merck Frosst Canada Ltd.	E002909	2009, 2	Négrier, Claude	E003153	2009, 3
Merck Frosst Canada Ltd.	E003419	2009, 5	Nestec S.A.	E002599	2009, 1
Merck Patent GmbH	E002716	2009, 1	Nestec S.A.	E002607	2009, 1
Merck Patent GmbH	E002925	2009, 2	Nestec S.A.	E002689	2009, 1
Merck Patent GmbH	E002931	2009, 2	Nestec S.A.	E002824	2009, 2
Merck Serono SA	E003313	2009, 4	Nestec S.A.	E003017	2009, 3
Merck Serono SA	E003427	2009, 5	Nestec S.A.	E003023	2009, 3
MERCKLE GMBH	E003327	2009, 4	Nestec S.A.	E003024	2009, 3
Merial Limited	E002747	2009, 1	Nestec S.A.	E003217	2009, 4
Merial Limited	E003120	2009, 3	Nestec S.A.	E003387	2009, 5
MERLONI PROGETTI S.p.A.	E003689	2009, 6	Nestec S.A.	E003388	2009, 5
Merz Pharma GmbH & Co. KGaA	E002612	2009, 1	Nestec S.A.	E003464	2009, 5
Merz Pharma GmbH & Co. KGaA	E002650	2009, 1	NEUROCRINE BIOSCIENCES, INC.	E002861	2009, 2
Merz Pharma GmbH & Co. KGaA	E003515	2009, 5	NeuroSearch A/S	E003574	2009, 6
Metalliasennus Huuhka OY	E002812	2009, 2	NeuTec Pharma Limited	E003155	2009, 3
Metsä Tissue Oyj	E003285	2009, 4	NeuTec Pharma Limited	E003263	2009, 4
Microstein LLC	E003275	2009, 4			

Patendiomanik	Registreeringu number	Patendilehe number, kus avaldati Euroopa patendikirjelduse tõlke esitamise teade
New West Gypsum Recycling (B.C.) Inc.	E002674	2009, 1
Newron Pharmaceuticals S.p.A.	E003408	2009, 5
NEXTER Systems	E002999	2009, 2
NicOx S.A.	E003473	2009, 5
NIPPON CHEMIPHAR CO., LTD.	E003492	2009, 5
NIPPON SODA CO., LTD.	E002927	2009, 2
Noell Mobile Systems GmbH	E002682	2009, 1
Nölle, Jürgen, Dipl.-Ing.	E003540	2009, 5
Nordpan Rubner Holzbauelemente GmbH	E002888	2009, 2
NORINCO	E002984	2009, 2
NORINCO	E003181	2009, 3
NORINCO	E003702	2009, 6
Northrop Grumman Information Technology, Inc.	E003203	2009, 3
Novartis AG	E003493	2009, 5
Novartis AG	E003575	2009, 6
Novartis AG	E003587	2009, 6
Novartis AG	E003589	2009, 6
Novartis AG	E003635	2009, 6
Novartis AG	E003646	2009, 6
Novartis AG	E003673	2009, 6
Novartis AG	E003677	2009, 6
Novartis AG	E003691	2009, 6
Novartis AG	E003697	2009, 6
Novartis Pharma GmbH	E003691	2009, 6
Novartis Vaccines and Diagnostics, Inc.	E002707	2009, 1
Novartis Vaccines and Diagnostics, Inc.	E003069	2009, 3
NOVARTIS AG	E002632	2009, 1
NOVARTIS AG	E002734	2009, 1
NOVARTIS AG	E002819	2009, 2
NOVARTIS AG	E002841	2009, 2
NOVARTIS AG	E002847	2009, 2
NOVARTIS AG	E002928	2009, 2
NOVARTIS AG	E002936	2009, 2
NOVARTIS AG	E003106	2009, 3
NOVARTIS AG	E003110	2009, 3
NOVARTIS AG	E003235	2009, 4
NOVARTIS AG	E003237	2009, 4
NOVARTIS AG	E003246	2009, 4
NOVARTIS AG	E003402	2009, 5
NOVARTIS AG	E003413	2009, 5
Novelix Pharmaceuticals, Inc.	E002955	2009, 2
Novo-Tech GmbH & Co. KG	E003355	2009, 4
Nusenbaum, Vyvyan Justin	E003523	2009, 5
Nycomed GmbH	E002635	2009, 1
Nycomed GmbH	E002875	2009, 2
Nycomed GmbH	E003617	2009, 6
Nycomed Pharma AS	E003400	2009, 5
O'Dowd, Brian, F.	E003362	2009, 4
OBO Bettermann GmbH & Co. KG	E003368	2009, 4
OBO Bettermann GmbH & Co. KG	E003721	2009, 6
OctoPlus PolyActive Sciences B.V.	E003396	2009, 5
Oldin, Karin	E002994	2009, 2
Olesch, Grzegorz	E003353	2009, 4
Olicon AB	E002987	2009, 2
Omega Pharma Capital NV	E003590	2009, 6
OMYA DEVELOPMENT AG	E003297	2009, 4
Oncotherapy Science, Inc.	E003511	2009, 5
onepharm Research & Development GmbH	E002846	2009, 2
OnLive, Inc.	E002797	2009, 1
OPUS nv	E003690	2009, 6
Ortho Biotech Products L.P.	E003430	2009, 5
Ortho-McNeil-Janssen Pharmaceuticals, Inc.	E002949	2009, 2
Ortho-McNeil-Janssen Pharmaceuticals, Inc.	E003320	2009, 4
Ortho-McNeil-Janssen Pharmaceuticals, Inc.	E003411	2009, 5
OSI Pharmaceuticals, Inc.	E003664	2009, 6
Osro GmbH	E003449	2009, 5
Österreichische Bundesbahnen	E002773	2009, 1
Oto Melara S.p.A.	E003454	2009, 5
Otsuka Pharmaceutical Co., Ltd.	E002858	2009, 2
Otsuka Pharmaceutical Company, Limited	E002645	2009, 1
OTSUKA PHARMACEUTICAL CO., LTD.	E002619	2009, 1
OTSUKA PHARMACEUTICAL CO., LTD.	E002745	2009, 1
OVD Kinegram AG	E002681	2009, 1
OVD Kinegram AG	E003088	2009, 3
OWENS-BROCKWAY GLASS CONTAINER INC.	E003601	2009, 6
OWENS-BROCKWAY GLASS CONTAINER INC.	E003716	2009, 6
Oxagen Limited	E003572	2009, 6
Oxibis Exalto SAS	E003199	2009, 3
Oy KWH Pipe AB	E003606	2009, 6
OY Lanh Ship AB	E003091	2009, 3
Panasonic Corporation	E003201	2009, 3
Pantarhei Bioscience B.V.	E002648	2009, 1
Pantarhei Bioscience B.V.	E003028	2009, 3
Parion Sciences, Inc.	E003015	2009, 3
Park, Jun-Hyuk	E003350	2009, 4
Paroc Oy Ab	E002779	2009, 1
Paroc Oy Ab	E003707	2009, 6
PASCHAL-WERK G. MAIER GmbH	E002782	2009, 1
Passavant-Roediger GmbH	E003099	2009, 3
Pavatex SA	E002776	2009, 1
Perio, Dudley J. Jr.	E002992	2009, 2
Peter Opsvik AS	E003562	2009, 6
Petratex-Confeccoes, S.A.	E003177	2009, 3
Petrella, Robert John	E002871	2009, 2
Pfeifer Holding GmbH & Co. KG	E002783	2009, 1
Pfeifer Holding GmbH & Co. KG	E003354	2009, 4
Pfizer Inc.	E002633	2009, 1
Pfizer, Inc.	E002737	2009, 1
PFIZER INC.	E002739	2009, 1

Patendiomanik	Registreeringu number	Patendilehe number, kus avaldati Euroopa patendikirjelduse tõlke esitamise teade		
Pfizer, Inc.	E002817	2009, 2	Protektorwerk Florenz Maisch	
PFIZER INC.	E002952	2009, 2	GmbH & Co. KG	E002989 2009, 2
Pfizer Italia S.r.l.	E002712	2009, 1	Protektorwerk Florenz Maisch	
Pfizer Limited	E002633	2009, 1	GmbH & Co. KG	E002778 2009, 1
Pfizer Limited	E003109	2009, 3	Protektorwerk Florenz Maisch	
Pfizer Limited	E003463	2009, 5	GmbH & Co. KG	E002780 2009, 1
Pfizer Products Inc.	E002618	2009, 1	Proyecto de Biomedicina Cima,	
Pfizer Products Inc.	E002657	2009, 1	S.L.	E002959 2009, 2
Pfizer Products Inc.	E003312	2009, 4	pSivida Inc.	E002658 2009, 1
Pfizer Products Inc.	E003346	2009, 4	Pürstinger, Gerhard	E003331 2009, 4
Pfizer Products Inc.	E003652	2009, 6	Quest Pharmaceutical Services	E003265 2009, 4
Pfizer Products Inc.	E003695	2009, 6	QUICKFLANGE AS	E003446 2009, 5
Pfizer Products Incorporated	E003339	2009, 4	RAIL.ONE GmbH	E002772 2009, 1
Pfizer Products Incorporated	E003648	2009, 6	Raisio plc	E003379 2009, 5
Pharma Mar S.A., Sociedad Unipersonal	E003430	2009, 5	Rautaruukki OYJ	E003281 2009, 4
Pharma Mar, S.A.U.	E002642	2009, 1	Rav-Bariach Vehicle Protection Ltd.	E002785 2009, 1
PHARMA-ZENTRALE GMBH	E002766	2009, 1	Ravintoraisio Oy	E003685 2009, 6
Pharmacia & Upjohn Company LLC	E002904	2009, 2	REGENERON	
Pharmacia Corporation	E003507	2009, 5	PHARMACEUTICALS, INC.	E003171 2009, 3
Pharmacon-Forschung und Beratung GmbH	E003668	2009, 6	REGENERON	
Pharmacoepia, LLC	E003497	2009, 5	PHARMACEUTICALS, INC.	E003341 2009, 4
Pharmacyclics, Inc.	E003628	2009, 6	REM Technologies, Inc.	E003449 2009, 5
PharmaNeuroBoost N.V.	E003234	2009, 4	Repros Therapeutics Inc.	E002629 2009, 1
Pharmaton S.A.	E002844	2009, 2	Resolution Chemicals Limited	E003267 2009, 4
Philip Morris Products S.A.	E002820	2009, 2	Retractable Technologies, Inc.	E003433 2009, 5
Philip Morris Products S.A.	E003095	2009, 3	Revolymmer Limited	E003160 2009, 3
Philip Morris Products S.A.	E003293	2009, 4	Rhea Vendors S.p.A.	E003715 2009, 6
Philip Morris Products S.A.	E003294	2009, 4	Rich Cup Bio-Chemical Technology Co., Ltd.	E003277 2009, 4
Philip Morris Products S.A.	E003383	2009, 5	Riemann Trading ApS	E003391 2009, 5
Philip Morris Products S.A.	E003544	2009, 5	Rijksuniversiteit Groningen	E003597 2009, 6
Philip Morris Products S.A.	E003560	2009, 6	Robel Bahnbaumaschinen GmbH	E003699 2009, 6
Philogen S.p.A.	E003512	2009, 5	Rojas Constantin, Ingrid	E003257 2009, 4
Physica Pharma	E003038	2009, 3	Rolls-Royce Marine AS	E003456 2009, 5
Pierre Fabre Dermo-Cosmétique	E002833	2009, 2	Royal Canin S.A.	E003221 2009, 4
Pierre Fabre Dermo-Cosmétique	E003586	2009, 6	Royal Nedalco B.V.	E003170 2009, 3
Pierre Fabre Medicament	E003579	2009, 6	Rummakko Oy	E003451 2009, 5
PIERRE FABRE MEDICAMENT	E002941	2009, 2	Sabancı Üniversitesi	E002770 2009, 1
PIERRE FABRE MEDICAMENT	E002974	2009, 2	Sachtleben Chemie GmbH	E003296 2009, 4
PIERRE FABRE MEDICAMENT	E003238	2009, 4	SAES GETTERS S.p.A.	E002800 2009, 1
Piippumies Oy	E003532	2009, 5	SAES GETTERS S.p.A.	E003173 2009, 3
Piskur, Jure	E003347	2009, 4	SAINT-GOBAIN GLASS FRANCE	E003725 2009, 6
Platco Technologies (Proprietary) Limited	E003505	2009, 5	Sammic, S.L.	E002826 2009, 2
POLICHEM S.A.	E002854	2009, 2	Sammic, S.L.	E002827 2009, 2
POLICHEM S.A.	E003585	2009, 6	Samsung Electronics Co., Ltd.	E003547 2009, 5
Polimeri Europa S.p.A.	E003471	2009, 5	Sandmeir-Exclusiv Stahlbau GmbH	E002775 2009, 1
PowderJect Research Limited	E003271	2009, 4	SANDOZ AG	E002839 2009, 2
Poxel SAS	E003124	2009, 3	sanofi-aventis	E003622 2009, 6
Preseco OY	E003100	2009, 3	Sanofi-Aventis Deutschland GmbH	E002664 2009, 1
Procter & Gamble Pharmaceuticals Iberia, S.L.	E003035	2009, 3	Sanofi-Aventis Deutschland GmbH	E002860 2009, 2
ProMetic BioSciences Inc.	E003046	2009, 3	Sanofi-Aventis Deutschland GmbH	E002950 2009, 2
Prosonix Limited	E003437	2009, 5	Sanofi-Aventis Deutschland GmbH	E002951 2009, 2
Protaffin Biotechnologie AG	E003676	2009, 6	Sanofi-Aventis Deutschland GmbH	E003040 2009, 3
			Sanofi-Aventis Deutschland GmbH	E003074 2009, 3
			Sanofi-Aventis Deutschland GmbH	E003103 2009, 3

Patendiomanik	Registreeringu number	Patendilehe number, kus avaldati Euroopa patendikirjelduse tõlke esitamise teade			
Sanofi-Aventis Deutschland GmbH	E003108	2009, 3	SICPA HOLDING S.A.	E003604	2009, 6
Sanofi-Aventis Deutschland GmbH	E003118	2009, 3	SIEMENS		
Sanofi-Aventis Deutschland GmbH	E003340	2009, 4	AKTIENGESELLSCHAFT	E002793	2009, 1
Sanofi-Aventis Deutschland GmbH	E003494	2009, 5	SIGMA-TAU Industrie		
Sanofi-Aventis Deutschland GmbH	E003595	2009, 6	Farmaceutiche Riunite S.p.A.	E002742	2009, 1
Sanofi-Aventis	E002705	2009, 1	SIGMA-TAU Industrie		
Sanofi-Aventis	E002710	2009, 1	Farmaceutiche Riunite S.p.A.	E002853	2009, 2
Sanofi-Aventis	E002721	2009, 1	SIGMA-TAU Industrie		
Sanofi-Aventis	E002907	2009, 2	Farmaceutiche Riunite S.p.A.	E002940	2009, 2
Sanofi-Aventis	E003132	2009, 3	SIGMA-TAU Industrie		
Sanofi-Aventis	E003134	2009, 3	Farmaceutiche Riunite S.p.A.	E002944	2009, 2
Sanofi-Aventis	E003137	2009, 3	SIGMA-TAU Industrie		
Sanofi-Aventis	E003158	2009, 3	Farmaceutiche Riunite S.p.A.	E002958	2009, 2
Sanofi-Aventis	E003241	2009, 4	SIGMA-TAU Industrie		
Sanofi-Aventis	E003322	2009, 4	Farmaceutiche Riunite S.p.A.	E003047	2009, 3
Sanofi-Aventis	E003418	2009, 5	SIGMA-TAU Industrie		
Sanofi-Aventis	E003500	2009, 5	Farmaceutiche Riunite S.p.A.	E003226	2009, 4
Sanofi-Aventis	E003647	2009, 6	SIGMA-TAU Industrie		
Sanofi-Aventis	E003661	2009, 6	Farmaceutiche Riunite S.p.A.	E003233	2009, 4
Sanofi-Aventis U.S. LLC	E003401	2009, 5	SIGMA-TAU Industrie		
Sanofi Pasteur	E002873	2009, 2	Farmaceutiche Riunite S.p.A.	E003333	2009, 4
Sanofi Pasteur	E003260	2009, 4	SIGMA-TAU Industrie		
Santana Milian, Héctor	E003257	2009, 4	Farmaceutiche Riunite S.p.A.	E003546	2009, 5
Sara Lee/DE N.V.	E003252	2009, 4	Signal Pharmaceuticals LLC	E003497	2009, 5
Sarl Locaboxe	E003529	2009, 5	Silence Therapeutics AG	E003152	2009, 3
SCA Hygiene Products AB	E002692	2009, 1	Silence Therapeutics		
Scason Oy	E003612	2009, 6	Aktiengesellschaft	E003259	2009, 4
Schering Aktiengesellschaft	E003671	2009, 6	Silgan Holdings Inc.	E003615	2009, 6
Schering Corporation	E002631	2009, 1	Simoens, Hervé Hubert Jean	E002897	2009, 2
Schering Corporation	E002652	2009, 1	Sinotex Investment & Development		
Schering Corporation	E003397	2009, 5	Co., Ltd.	E002769	2009, 1
Schering Corporation	E003502	2009, 5	Sirion Therapeutics, Inc.	E002850	2009, 2
Schering Corporation	E003682	2009, 6	Slipcon Holding International ApS	E002677	2009, 1
Scheuten Glasgroep	E002801	2009, 1	Sloan-Kettering Institute For Cancer		
Schill & Seilacher AG	E002968	2009, 2	Research	E002862	2009, 2
Schmauser, Wolfgang	E002886	2009, 2	SmartTrust AB	E003012	2009, 2
Schock GmbH	E002754	2009, 1	SMITHKLINE BEECHAM		
SCHÖCK BAUTEILE GmbH	E002986	2009, 2	CORPORATION	E002717	2009, 1
SCHÜCO International KG	E002787	2009, 1	SMITHKLINE BEECHAM		
Scierie Piveteau	E002898	2009, 2	CORPORATION	E002856	2009, 2
SCS Automaberg SNC	E003609	2009, 6	SMITHKLINE BEECHAM		
Scuderi Group LLC	E003190	2009, 3	CORPORATION	E003258	2009, 4
Scuderi Group LLC	E003536	2009, 5	SOLMAG S.p.A.	E003643	2009, 6
Scytl Secure Electronic Voting, S.A.	E003545	2009, 5	Solvay Pharmaceuticals B.V.	E002634	2009, 1
SEBIA	E003195	2009, 3	Solvay Pharmaceuticals B.V.	E002646	2009, 1
Seiko Epson Corporation	E003086	2009, 3	Solvay Pharmaceuticals B.V.	E002711	2009, 1
Selex Communications S.P.A.	E003006	2009, 2	Solvay Pharmaceuticals B.V.	E002857	2009, 2
SERAC GROUP	E003538	2009, 5	Solvay Pharmaceuticals B.V.	E002914	2009, 2
Sersa AG	E002980	2009, 2	Solvay Pharmaceuticals B.V.	E002915	2009, 2
SES Astra S.A.	E003364	2009, 4	Solvay Pharmaceuticals B.V.	E003125	2009, 3
SHELL INTERNATIONALE RESEARCH MAATSCHAPPIJ B.V.	E002788	2009, 1	Solvay Pharmaceuticals GmbH	E002748	2009, 1
SICA S.P.A.	E003084	2009, 3	Solvay Pharmaceuticals GmbH	E003253	2009, 4
SICPA HOLDING S.A.	E003162	2009, 3	Solvay Pharmaceuticals GmbH	E003566	2009, 6
SICPA HOLDING S.A.	E003278	2009, 4	Sonitron, naamloze Vennootschap	E002810	2009, 1
			Soparfin SA	E002825	2009, 2
			Sorain Cecchini Ambiente SCA		
			S.p.A.	E003279	2009, 4

Patendiomanik	Registreeringu number	Patendilehe number, kus avaldati Euroopa patendikirjelduse tõlke esitamise teade			
Sotolongo Pena, Jorge	E003257	2009, 4	TeliaSonera Finland Oyj	E003205	2009, 3
Spraydown Limited	E003613	2009, 6	TeliaSonera Finland Oyj	E003551	2009, 5
Statens Serum Institut	E002617	2009, 1	TELIASONERA AB	E003009	2009, 2
StatoilHydro ASA	E002693	2009, 1	TELIASONERA AB	E003550	2009, 5
Stiftung Alfred-Wegener-Institut für Polar- und Meeresforschung	E003559	2009, 6	TELIASONERA AB	E003724	2009, 6
Stokke AS	E002822	2009, 2	TELIK, INC.	E002956	2009, 2
Südzucker Aktiengesellschaft Mannheim/Ochsenfurt	E003518	2009, 5	TELIK, INC.	E002976	2009, 2
Sulzer Metco (Canada) Inc.	E003719	2009, 6	TENDENZA SCHUHHANDELSGES.		
Sumitomo Chemical Company, Limited	E003629	2009, 6	MBH & CO. KG	E002821	2009, 2
SUN CHEMICAL CORPORATION	E003286	2009, 4	Terumo Corporation	E002664	2009, 1
Sunho Biodiesel Corporation	E003348	2009, 4	Terumo Corporation	E003595	2009, 6
Sunshower B.V.	E002669	2009, 1	The Arizona Board of Regents on behalf of the University of Arizona	E002628	2009, 1
Superfos A/S	E002687	2009, 1	The Arizona Board of Regents on behalf of the University of Arizona	E003654	2009, 6
Superfos A/S	E003611	2009, 6	The Children`s Medical Center Corporation	E003417	2009, 5
SuperGen, Inc.	E003654	2009, 6	The Coca-Cola Company	E002602	2009, 1
Suven Life Sciences Limited	E003334	2009, 4	The Female Health Company (UK) PLC	E003565	2009, 6
Suven Life Sciences Limited	E003504	2009, 5	The Gillette Company	E002887	2009, 2
Sveinsson, Birkir	E003231	2009, 4	The Regents of the University of California	E002960	2009, 2
SWEP International AB	E003603	2009, 6	THE OPEN UNIVERSITY	E002877	2009, 2
Syngenta Limited	E003372	2009, 5	THE SCRIPPS RESEARCH INSTITUTE	E002796	2009, 1
Syngenta Limited	E003556	2009, 6	THE SCRIPPS RESEARCH INSTITUTE	E003693	2009, 6
Syngenta Participations AG	E002596	2009, 1	Theravance, Inc.	E003133	2009, 3
Syngenta Participations AG	E003117	2009, 3	Theravance, Inc.	E003304	2009, 4
Syngenta Participations AG	E003441	2009, 5	Theravance, Inc.	E003305	2009, 4
Syngenta Participations AG	E003556	2009, 6	Thomé, Geninho	E002830	2009, 2
Synteco S.p.A.	E002696	2009, 1	Tibotec Pharmaceuticals Ltd.	E003503	2009, 5
Syntex Uruguay, S.A.	E003679	2009, 6	Tissage et Enduction Serge Ferrari SA	E002891	2009, 2
Synvolux IP B.V.	E003167	2009, 3	Tonello, Gino	E003007	2009, 2
Synvolux IP B.V.	E003168	2009, 3	Tonello, Mirko	E003007	2009, 2
Synvolux IP B.V.	E003169	2009, 3	TopoTarget Germany AG	E002626	2009, 1
T-Mobile Deutschland GmbH	E003548	2009, 5	TracTechnology AB	E003543	2009, 5
T-Mobile Deutschland GmbH	E003723	2009, 6	TREVIRA GMBH	E002900	2009, 2
TAISHO PHARMACEUTICAL CO., LTD.	E002656	2009, 1	Tsaur, Garry	E002668	2009, 1
Takeda Pharmaceutical Company Limited	E002718	2009, 1	Tseti, Ioulia	E003649	2009, 6
Takeda Pharmaceutical Company Limited	E003135	2009, 3	TÜBITAK Türkiye Bilimsel ve Teknolojik Arastirma Kurumu	E002770	2009, 1
TAKEDA PHARMACEUTICAL COMPANY LIMITED	E003657	2009, 6	Twee "R" Recycling Groep B.V.	E003442	2009, 5
TARTUNTAMARKKINOINTI OY	E002985	2009, 2	Under-Cover	E003530	2009, 5
Technip France SA	E002998	2009, 2	UNIBIND (CYPRUS) LIMITED	E002892	2009, 2
Technische Universiteit Delft	E003467	2009, 5	Unified messaging systems as	E002809	2009, 1
Tedec-Meiji Farma, S.A.	E003679	2009, 6	Universidad De Salamanca (O.T.R.I.)	E002761	2009, 1
Tehalit GmbH	E002803	2009, 1	UNIVERSITE DE POITIERS	E003416	2009, 5
Tehalit GmbH	E002804	2009, 1	Université de Montréal	E003404	2009, 5
Tehalit GmbH	E003008	2009, 2	Université de Strasbourg	E003321	2009, 4
Tehalit GmbH	E003720	2009, 6	Université du Luxembourg	E003321	2009, 4
Teliasonera AB	E003549	2009, 5	University Health Network	E003266	2009, 4
TeliaSonera AB	E002808	2009, 1	University of Cape Town	E003336	2009, 4
TeliaSonera Finland Oyj	E002807	2009, 1			
TeliaSonera Finland Oyj	E003204	2009, 3			

Patendiomanik	Registreeringu number	Patendilehe number, kus avaldati Euroopa patendikirjelduse tõlke esitamise teade			
University of Iowa Research Foundation	E002876	2009, 2	W.C. Heraeus GmbH	E003520	2009, 5
University of South Florida	E003517	2009, 5	W.L. Gore Associates GmbH	E002604	2009, 1
University of Tennessee Research Foundation	E003626	2009, 6	W.T.E. Waste to Energy S.R.L.	E003359	2009, 4
UNIVERSITY COLLEGE LONDON	E003380	2009, 5	Warner-Lambert Company LLC	E002735	2009, 1
UPC Broadband Operations B.V.	E003011	2009, 2	Warner-Lambert Company LLC	E003625	2009, 6
Uponor Innovation AB	E003468	2009, 5	Wei, Edward T.	E003627	2009, 6
Urovision Gesellschaft für Medizinischen Technologie Transfer mbH	E003564	2009, 6	Weike (S) PTE Ltd.	E003436	2009, 5
URSAPHARM Arzneimittel GmbH & Co. KG	E003224	2009, 4	Welser Profile AG	E002885	2009, 2
Utexbel NV	E003698	2009, 6	Welser Profile AG	E003444	2009, 5
V. Mane Fils	E003561	2009, 6	Welser Profile AG	E003445	2009, 5
VAE EISENBAHNSYSTEME GMBH	E002676	2009, 1	Werner, Hans Jürgen	E002896	2009, 2
VAE EISENBAHNSYSTEME GMBH	E003180	2009, 3	WHITEHEAD INSTITUTE FOR BIOMEDICAL RESEARCH	E002961	2009, 2
VAE GmbH	E002676	2009, 1	Wida Media AB	E003021	2009, 3
VAE GmbH	E003180	2009, 3	WIENER LINIEN GMBH & CO KG	E002773	2009, 1
Valdes Perez, Calixto	E003257	2009, 4	Windcat Workboats Limited	E002893	2009, 2
Välinge Innovation AB	E003706	2009, 6	WISCONSIN ALUMNI RESEARCH FOUNDATION	E002906	2009, 2
Van Camp, Guido L. P.	E003351	2009, 4	Wobben, Aloys	E002790	2009, 1
Varco I/P, Inc.	E002993	2009, 2	Wobben, Aloys	E003079	2009, 3
VBG GROUP TRUCK EQUIPMENT GmbH	E003089	2009, 3	Wobben, Aloys	E003191	2009, 3
Veerhuis Beheer B.V.	E002988	2009, 2	Wobben, Aloys	E003537	2009, 5
Vejjlen N.V.	E003412	2009, 5	Wobben, Aloys	E003711	2009, 6
Verdera Oy	E002971	2009, 2	Wyeth	E002595	2009, 1
VERTEX PHARMACEUTICALS INCORPORATED	E003651	2009, 6	Wyeth	E002653	2009, 1
VERTEX PHARMACEUTICALS INCORPORATED	E003662	2009, 6	Wyeth	E002842	2009, 2
Verum Holding B.V.	E003718	2009, 6	Wyeth Holdings Corporation	E002752	2009, 1
Vetrotech Saint-Gobain (International) AG	E002694	2009, 1	Äterna Zentaris GmbH	E002935	2009, 2
ViskoTeepak Belgium NV	E002597	2009, 1	X-Technology Swiss GmbH	E003019	2009, 3
Vlaamse Instelling voor Technologisch Onderzoek (VITO)	E003081	2009, 3	X-Technology Swiss GmbH	E003212	2009, 4
voestalpine Krems Finaltechnik GmbH	E003700	2009, 6	X-Technology Swiss GmbH	E003213	2009, 4
voestalpine Schienen GmbH	E003448	2009, 5	X-Technology Swiss GmbH	E003384	2009, 5
Volkov, Yuriy Sergeevich	E003174	2009, 3	Xigen S.A.	E003065	2009, 3
Vrije Universiteit Brussel VUB	E003690	2009, 6	YEDA RESEARCH AND DEVELOPMENT CO., LTD.	E003066	2009, 3
Vulkan Lokring- Rohrverbindungen GmbH & Co. KG	E002997	2009, 2	You, Hack-Churl	E003350	2009, 4
			Yoz-Ami Corporation	E003524	2009, 5
			Zentiva, A.S	E003311	2009, 4
			Zentiva, a.s.	E002942	2009, 2
			Zentiva, a.s.	E002946	2009, 2
			ZETAPLAST S.p.A.	E003465	2009, 5
			Ziel Biopharma Ltd	E003157	2009, 3
			Zimmer, Günther Stephan	E002792	2009, 1
			Zimmer, Martin Johannes	E002792	2009, 1

AA1Y. TÄIENDAVA KAITSE TAOTLUSTE NUMBRILINE LOEND

Täiendava kaitse taotluse number	Aluspatendi number	Meditsiini- või taimekaitsetoote registreerimist tõendava dokumendi number	Patendilehe number, kus avaldati täiendava kaitse taotluse esitamise teade
C20080005	04616	C(2008)2742	2009, 1
C20080006	05086	C(2008)4744	2009, 1
C20090001	E002909	K(2008)3457	2009, 3
C20090002	05110	C(2007)4383-COR	2009, 4
C20090003	03974	K(2009)1188	2009, 4
C20090004	05169	K(2008)5680	2009, 5
C20090005	05128	RVG 33842	2009, 5

FG1Y. TÄIENDAVA KAITSE TUNNISTUSTE NUMBRILINE LOEND

Tunnistuse number	Täiendava kaitse taotluse number	Aluspatendi number	Meditsiini- või taimekaitsetoote registreerimist tõendava dokumendi number	Patendilehe number, kus avaldati täiendava kaitse andmise teade
00020	C20080005	04616	C(2008)2742	2009, 1
00021	C20080006	05086	C(2008)4744	2009, 1
00022	C20090001	E002909	K(2008)3457	2009, 3
00023	C20090002	05110	C(2007)4383-COR	2009, 5
00024	C20090003	03974	K(2009)1188	2009, 5
00025	C20090004	05169	K(2008)5680	2009, 5
00026	C20090005	05128	RVG 33842	2009, 6

**ND4A. KEHTIVATE PATENTIDE NUMBRILINE LOEND
SEISUGA 31.12.2009**

Patendi number

02934	03099	03238	03387	03501	03618	03742	03855	03951	04045
02941	03100	03240	03388	03502	03622	03744	03856	03952	04046
02942	03106	03241	03394	03504	03623	03746	03857	03954	04047
02943	03107	03244	03396	03505	03624	03747	03862	03956	04050
02946	03108	03250	03398	03506	03627	03751	03864	03960	04051
02962	03109	03251	03399	03507	03628	03752	03865	03961	04053
02966	03113	03256	03402	03508	03630	03753	03866	03962	04054
02968	03118	03257	03403	03509	03631	03754	03869	03967	04057
02969	03119	03260	03406	03511	03639	03758	03872	03969	04058
02970	03122	03263	03407	03512	03643	03759	03873	03972	04059
02974	03124	03264	03411	03513	03644	03768	03875	03973	04063
02976	03125	03266	03412	03515	03645	03771	03876	03974	04065
02980	03126	03267	03413	03518	03648	03773	03879	03975	04067
02991	03127	03268	03414	03519	03650	03774	03887	03977	04068
02995	03128	03270	03422	03526	03652	03775	03889	03978	04071
02996	03132	03275	03423	03527	03654	03777	03890	03980	04073
02998	03134	03278	03424	03528	03655	03779	03891	03983	04074
03000	03140	03282	03426	03529	03656	03781	03892	03984	04075
03001	03142	03292	03427	03531	03657	03782	03893	03985	04077
03002	03143	03294	03432	03532	03659	03784	03894	03987	04078
03003	03147	03295	03433	03533	03660	03786	03895	03989	04080
03007	03148	03297	03435	03535	03661	03789	03896	03991	04083
03012	03151	03299	03436	03539	03663	03791	03897	03992	04084
03017	03157	03302	03438	03542	03664	03792	03898	03993	04086
03019	03158	03305	03442	03544	03667	03797	03899	03994	04088
03028	03160	03310	03444	03545	03670	03798	03901	03996	04090
03029	03164	03311	03448	03546	03671	03802	03902	03997	04091
03034	03165	03313	03449	03547	03672	03804	03903	03998	04093
03036	03171	03315	03453	03548	03675	03808	03904	03999	04094
03042	03172	03318	03455	03549	03676	03809	03905	04000	04096
03044	03176	03332	03463	03550	03677	03815	03907	04002	04097
03045	03179	03333	03465	03551	03680	03816	03910	04003	04102
03046	03181	03334	03467	03554	03685	03820	03911	04004	04104
03047	03188	03335	03468	03555	03687	03821	03913	04005	04107
03049	03189	03336	03469	03556	03688	03824	03915	04006	04108
03052	03192	03337	03470	03559	03691	03825	03916	04007	04112
03054	03194	03339	03471	03560	03692	03827	03917	04008	04113
03057	03197	03341	03473	03562	03694	03829	03920	04010	04114
03064	03202	03342	03474	03568	03697	03830	03923	04011	04116
03067	03203	03351	03475	03573	03698	03831	03924	04013	04119
03069	03204	03353	03477	03575	03699	03832	03925	04014	04124
03070	03205	03354	03478	03576	03704	03836	03927	04022	04129
03071	03207	03359	03480	03579	03707	03837	03928	04024	04133
03074	03211	03360	03482	03587	03712	03838	03929	04026	04136
03077	03217	03363	03483	03588	03713	03840	03930	04027	04140
03078	03219	03364	03484	03590	03716	03842	03932	04028	04143
03084	03221	03366	03485	03591	03717	03844	03934	04029	04144
03085	03222	03371	03486	03594	03719	03845	03936	04031	04146
03086	03223	03372	03487	03604	03723	03846	03937	04034	04148
03087	03224	03374	03488	03605	03726	03847	03938	04035	04152
03089	03227	03375	03489	03606	03728	03848	03941	04038	04153
03091	03228	03376	03490	03607	03730	03851	03942	04039	04155
03092	03230	03379	03492	03608	03731	03852	03943	04041	04157
03093	03231	03383	03499	03609	03733	03853	03944	04042	04159
03095	03236	03386	03500	03613	03740	03854	03949	04044	04160

Patendi number

04162	04265	04359	04435	04515	04599	04674	04751	04823	04896
04163	04266	04360	04436	04517	04601	04675	04752	04824	04897
04165	04267	04361	04437	04518	04604	04676	04753	04826	04898
04168	04268	04362	04438	04519	04606	04677	04756	04828	04899
04169	04269	04363	04440	04520	04608	04678	04757	04829	04902
04170	04270	04365	04441	04521	04610	04679	04758	04830	04903
04172	04271	04366	04442	04522	04611	04682	04759	04831	04904
04173	04273	04368	04443	04523	04612	04683	04760	04833	04905
04175	04275	04369	04444	04524	04613	04684	04761	04834	04906
04178	04277	04370	04445	04525	04614	04685	04762	04836	04909
04181	04278	04372	04447	04529	04615	04686	04763	04837	04910
04182	04279	04374	04448	04531	04616	04687	04764	04838	04912
04183	04281	04377	04449	04532	04621	04688	04765	04839	04913
04184	04284	04378	04450	04533	04622	04691	04766	04840	04915
04185	04285	04379	04451	04534	04623	04692	04767	04841	04916
04186	04286	04381	04452	04536	04624	04694	04768	04842	04917
04188	04287	04382	04453	04537	04626	04695	04769	04843	04918
04189	04288	04383	04454	04538	04627	04697	04771	04847	04919
04192	04289	04384	04455	04540	04628	04698	04773	04848	04920
04193	04290	04385	04456	04541	04629	04699	04774	04850	04921
04194	04291	04386	04457	04542	04630	04701	04775	04851	04922
04198	04292	04387	04458	04544	04631	04702	04776	04852	04923
04199	04293	04388	04459	04545	04632	04703	04777	04853	04924
04201	04294	04389	04460	04548	04633	04705	04778	04854	04925
04202	04296	04391	04462	04550	04634	04706	04779	04855	04926
04205	04297	04392	04465	04551	04635	04707	04780	04856	04927
04206	04300	04394	04466	04552	04636	04708	04781	04859	04928
04214	04306	04395	04467	04556	04640	04709	04782	04860	04929
04215	04307	04397	04468	04557	04642	04710	04783	04861	04930
04216	04309	04398	04470	04559	04643	04712	04784	04862	04931
04217	04313	04399	04471	04560	04644	04713	04785	04863	04932
04218	04314	04400	04473	04561	04645	04715	04786	04864	04933
04220	04315	04401	04474	04562	04646	04716	04790	04865	04934
04221	04316	04402	04475	04563	04647	04718	04791	04866	04935
04222	04317	04403	04476	04566	04648	04720	04792	04867	04936
04223	04321	04405	04479	04567	04649	04722	04793	04869	04937
04225	04323	04406	04481	04569	04650	04724	04796	04870	04939
04227	04327	04407	04484	04572	04652	04725	04797	04872	04940
04229	04328	04408	04485	04573	04653	04726	04798	04873	04941
04234	04329	04409	04487	04574	04654	04727	04800	04874	04942
04237	04330	04410	04488	04575	04655	04729	04801	04875	04943
04239	04331	04411	04489	04576	04656	04731	04802	04876	04944
04240	04332	04413	04490	04578	04657	04732	04803	04878	04946
04241	04335	04414	04492	04579	04658	04733	04804	04879	04947
04243	04336	04415	04493	04580	04659	04734	04805	04880	04949
04245	04337	04418	04495	04582	04660	04735	04806	04881	04950
04246	04338	04419	04497	04583	04661	04736	04807	04882	04951
04247	04339	04420	04498	04584	04662	04737	04808	04883	04952
04248	04343	04421	04499	04585	04663	04738	04809	04884	04953
04249	04344	04423	04500	04586	04664	04740	04811	04885	04954
04250	04345	04424	04502	04587	04665	04741	04812	04887	04955
04251	04347	04425	04504	04588	04666	04742	04813	04888	04956
04253	04348	04426	04505	04589	04667	04743	04814	04889	04957
04254	04351	04427	04506	04590	04668	04744	04817	04890	04959
04255	04352	04428	04507	04591	04669	04745	04818	04891	04960
04256	04353	04429	04508	04592	04670	04747	04819	04892	04961
04259	04354	04431	04511	04596	04671	04748	04820	04893	04962
04262	04355	04433	04512	04597	04672	04749	04821	04894	04963
04263	04357	04434	04514	04598	04673	04750	04822	04895	04964

Patendi number									
04965	05000	05034	05063	05092	05120	05149	05177	05205	05233
04966	05003	05035	05064	05093	05121	05150	05178	05206	05234
04967	05004	05036	05065	05094	05122	05151	05179	05207	05235
04969	05005	05037	05066	05095	05123	05152	05180	05208	05236
04970	05006	05038	05067	05096	05124	05153	05181	05209	05237
04971	05008	05039	05068	05097	05125	05154	05182	05210	05238
04972	05011	05040	05069	05098	05126	05155	05183	05211	05239
04973	05012	05041	05070	05099	05127	05156	05184	05212	05240
04975	05013	05042	05071	05100	05128	05157	05185	05213	05241
04977	05014	05043	05072	05101	05129	05158	05186	05214	05242
04978	05015	05044	05073	05102	05130	05159	05187	05215	05243
04979	05016	05045	05074	05103	05131	05160	05188	05216	05244
04980	05017	05046	05075	05104	05132	05161	05189	05217	05245
04981	05018	05047	05076	05105	05133	05162	05190	05218	05246
04982	05019	05049	05077	05106	05134	05163	05191	05219	05247
04983	05020	05050	05078	05107	05135	05164	05192	05220	05248
04984	05021	05051	05079	05108	05136	05165	05193	05221	05249
04985	05022	05052	05080	05109	05137	05166	05194	05222	05250
04990	05023	05053	05081	05110	05138	05167	05195	05223	05251
04991	05024	05054	05082	05111	05139	05168	05196	05224	05252
04992	05025	05055	05083	05112	05140	05169	05197	05225	05253
04993	05026	05056	05084	05113	05141	05170	05198	05226	
04994	05028	05057	05085	05114	05142	05171	05199	05227	
04995	05029	05058	05086	05115	05144	05172	05200	05228	
04996	05030	05059	05087	05116	05145	05173	05201	05229	
04997	05031	05060	05088	05117	05146	05174	05202	05230	
04998	05032	05061	05089	05118	05147	05175	05203	05231	
04999	05033	05062	05091	05119	05148	05176	05204	05232	

**ND4A. EESTIS KEHTIVATE EUROOPA PATENTIDE NUMBRILINE LOEND
SEISUGA 31.12.2009**

Registreeringu number								
E000001	E000033	E000059	E000090	E000119	E000143	E000169	E000195	E000218
E000002	E000034	E000061	E000091	E000120	E000144	E000170	E000196	E000219
E000003	E000035	E000063	E000092	E000121	E000145	E000171	E000197	E000220
E000005	E000036	E000064	E000093	E000122	E000146	E000172	E000198	E000221
E000006	E000037	E000065	E000095	E000125	E000147	E000174	E000199	E000222
E000008	E000038	E000066	E000097	E000126	E000148	E000175	E000200	E000223
E000010	E000041	E000067	E000098	E000128	E000149	E000176	E000201	E000224
E000012	E000042	E000068	E000099	E000129	E000150	E000177	E000202	E000225
E000016	E000043	E000071	E000101	E000130	E000152	E000179	E000203	E000226
E000017	E000044	E000072	E000103	E000131	E000153	E000180	E000204	E000227
E000018	E000045	E000073	E000104	E000132	E000154	E000181	E000205	E000228
E000019	E000046	E000074	E000106	E000133	E000155	E000182	E000208	E000229
E000020	E000047	E000076	E000107	E000134	E000156	E000183	E000209	E000230
E000023	E000048	E000078	E000108	E000135	E000159	E000184	E000210	E000232
E000024	E000049	E000080	E000109	E000136	E000160	E000186	E000211	E000233
E000025	E000051	E000082	E000111	E000137	E000162	E000187	E000212	E000234
E000026	E000054	E000083	E000112	E000138	E000164	E000188	E000213	E000235
E000027	E000055	E000084	E000113	E000139	E000165	E000189	E000214	E000236
E000028	E000056	E000085	E000115	E000140	E000166	E000190	E000215	E000237
E000030	E000057	E000086	E000116	E000141	E000167	E000191	E000216	E000238
E000031	E000058	E000089	E000118	E000142	E000168	E000192	E000217	E000239

Registreeringu number								
E000240	E000317	E000394	E000471	E000543	E000619	E000695	E000764	E000849
E000241	E000318	E000395	E000472	E000544	E000620	E000696	E000765	E000853
E000242	E000319	E000396	E000473	E000545	E000621	E000698	E000766	E000856
E000244	E000320	E000397	E000474	E000547	E000622	E000699	E000767	E000857
E000245	E000321	E000398	E000476	E000548	E000623	E000700	E000768	E000858
E000246	E000323	E000399	E000477	E000549	E000625	E000701	E000769	E000859
E000248	E000324	E000400	E000478	E000550	E000626	E000702	E000771	E000860
E000249	E000327	E000401	E000481	E000552	E000627	E000703	E000774	E000861
E000250	E000328	E000402	E000482	E000553	E000629	E000704	E000775	E000862
E000252	E000330	E000403	E000484	E000555	E000630	E000705	E000776	E000863
E000253	E000332	E000404	E000485	E000556	E000632	E000707	E000777	E000864
E000254	E000333	E000405	E000486	E000557	E000633	E000709	E000778	E000865
E000255	E000337	E000406	E000487	E000558	E000634	E000710	E000779	E000866
E000258	E000339	E000407	E000488	E000559	E000635	E000711	E000780	E000867
E000260	E000340	E000408	E000490	E000561	E000636	E000712	E000781	E000868
E000261	E000341	E000409	E000491	E000562	E000638	E000713	E000782	E000869
E000262	E000342	E000411	E000492	E000563	E000639	E000714	E000784	E000871
E000263	E000343	E000412	E000493	E000564	E000640	E000715	E000785	E000872
E000268	E000344	E000413	E000494	E000567	E000641	E000717	E000786	E000873
E000269	E000345	E000414	E000497	E000568	E000642	E000718	E000787	E000874
E000270	E000346	E000415	E000498	E000569	E000644	E000719	E000790	E000875
E000271	E000349	E000416	E000499	E000570	E000646	E000721	E000792	E000876
E000272	E000350	E000417	E000500	E000573	E000647	E000722	E000795	E000878
E000277	E000352	E000418	E000501	E000574	E000648	E000723	E000796	E000879
E000278	E000353	E000421	E000502	E000575	E000650	E000724	E000798	E000880
E000279	E000354	E000423	E000505	E000576	E000651	E000725	E000799	E000881
E000280	E000355	E000425	E000506	E000577	E000652	E000726	E000800	E000882
E000281	E000357	E000426	E000507	E000579	E000654	E000727	E000801	E000883
E000283	E000358	E000427	E000508	E000580	E000655	E000728	E000802	E000884
E000284	E000359	E000429	E000509	E000582	E000656	E000730	E000805	E000885
E000285	E000360	E000430	E000510	E000583	E000657	E000731	E000806	E000886
E000286	E000361	E000431	E000511	E000585	E000658	E000732	E000807	E000887
E000287	E000362	E000432	E000512	E000586	E000659	E000733	E000808	E000888
E000288	E000363	E000434	E000514	E000587	E000660	E000734	E000809	E000889
E000289	E000364	E000435	E000515	E000588	E000661	E000736	E000811	E000892
E000290	E000365	E000437	E000518	E000589	E000662	E000737	E000812	E000894
E000291	E000367	E000441	E000519	E000590	E000663	E000738	E000813	E000895
E000293	E000368	E000442	E000520	E000591	E000664	E000740	E000814	E000896
E000294	E000369	E000443	E000521	E000594	E000665	E000741	E000815	E000897
E000295	E000371	E000444	E000522	E000595	E000666	E000743	E000816	E000898
E000296	E000372	E000445	E000523	E000596	E000668	E000744	E000818	E000899
E000297	E000374	E000447	E000524	E000598	E000670	E000745	E000819	E000900
E000298	E000376	E000448	E000525	E000599	E000671	E000746	E000823	E000901
E000300	E000377	E000449	E000526	E000601	E000672	E000747	E000824	E000902
E000303	E000378	E000451	E000527	E000602	E000674	E000748	E000826	E000903
E000304	E000379	E000453	E000529	E000605	E000675	E000749	E000827	E000905
E000305	E000380	E000455	E000530	E000606	E000676	E000750	E000829	E000908
E000306	E000381	E000456	E000531	E000607	E000677	E000751	E000831	E000909
E000307	E000382	E000459	E000532	E000608	E000678	E000753	E000833	E000910
E000308	E000383	E000460	E000533	E000609	E000680	E000755	E000834	E000911
E000309	E000384	E000461	E000534	E000610	E000681	E000756	E000835	E000912
E000310	E000385	E000463	E000535	E000611	E000682	E000757	E000836	E000915
E000311	E000388	E000464	E000537	E000612	E000687	E000758	E000840	E000916
E000312	E000389	E000466	E000538	E000613	E000688	E000759	E000841	E000917
E000313	E000390	E000467	E000539	E000614	E000689	E000760	E000842	E000918
E000314	E000391	E000468	E000540	E000615	E000691	E000761	E000846	E000919
E000315	E000392	E000469	E000541	E000616	E000692	E000762	E000847	E000920
E000316	E000393	E000470	E000542	E000618	E000694	E000763	E000848	E000921

Registreeringu number								
E000923	E001001	E001070	E001139	E001202	E001274	E001335	E001408	E001481
E000924	E001002	E001071	E001140	E001204	E001275	E001336	E001409	E001482
E000925	E001004	E001072	E001141	E001206	E001276	E001338	E001410	E001483
E000926	E001005	E001073	E001142	E001207	E001277	E001339	E001412	E001484
E000927	E001006	E001074	E001143	E001209	E001279	E001340	E001413	E001485
E000928	E001007	E001075	E001145	E001210	E001280	E001341	E001415	E001487
E000929	E001008	E001076	E001147	E001212	E001281	E001342	E001416	E001488
E000930	E001009	E001077	E001148	E001213	E001282	E001343	E001417	E001489
E000931	E001010	E001078	E001150	E001214	E001283	E001344	E001419	E001490
E000932	E001012	E001079	E001151	E001215	E001284	E001345	E001420	E001491
E000933	E001013	E001080	E001152	E001216	E001285	E001346	E001421	E001492
E000934	E001014	E001081	E001153	E001217	E001286	E001347	E001422	E001493
E000935	E001015	E001084	E001154	E001219	E001287	E001348	E001423	E001494
E000936	E001017	E001085	E001155	E001221	E001288	E001349	E001424	E001495
E000937	E001018	E001086	E001156	E001222	E001289	E001351	E001425	E001496
E000939	E001019	E001088	E001157	E001223	E001290	E001352	E001427	E001498
E000940	E001020	E001089	E001158	E001224	E001291	E001353	E001428	E001499
E000944	E001022	E001090	E001159	E001226	E001292	E001354	E001430	E001500
E000945	E001024	E001091	E001161	E001227	E001293	E001355	E001431	E001501
E000946	E001025	E001092	E001162	E001228	E001294	E001356	E001432	E001502
E000947	E001027	E001093	E001163	E001229	E001295	E001357	E001435	E001503
E000948	E001028	E001094	E001164	E001230	E001296	E001358	E001437	E001504
E000949	E001030	E001095	E001165	E001231	E001297	E001359	E001438	E001505
E000950	E001031	E001096	E001166	E001232	E001298	E001360	E001439	E001506
E000951	E001032	E001097	E001167	E001234	E001299	E001361	E001440	E001507
E000952	E001033	E001098	E001168	E001235	E001300	E001362	E001443	E001508
E000954	E001034	E001100	E001169	E001237	E001302	E001363	E001444	E001509
E000956	E001035	E001101	E001170	E001239	E001304	E001365	E001445	E001511
E000957	E001036	E001102	E001171	E001240	E001305	E001366	E001446	E001513
E000959	E001037	E001103	E001172	E001241	E001306	E001367	E001448	E001514
E000960	E001038	E001104	E001173	E001242	E001307	E001368	E001449	E001515
E000961	E001039	E001106	E001174	E001243	E001308	E001369	E001450	E001516
E000962	E001040	E001107	E001175	E001245	E001309	E001370	E001451	E001517
E000963	E001041	E001108	E001176	E001246	E001310	E001371	E001452	E001518
E000964	E001042	E001109	E001177	E001247	E001311	E001372	E001454	E001519
E000966	E001043	E001110	E001178	E001248	E001312	E001374	E001455	E001520
E000967	E001044	E001111	E001179	E001249	E001313	E001375	E001456	E001521
E000968	E001046	E001112	E001180	E001250	E001314	E001379	E001457	E001522
E000969	E001047	E001113	E001181	E001251	E001315	E001380	E001458	E001523
E000970	E001048	E001114	E001182	E001252	E001316	E001382	E001459	E001524
E000972	E001049	E001115	E001183	E001253	E001317	E001384	E001460	E001525
E000973	E001050	E001116	E001184	E001254	E001318	E001385	E001461	E001526
E000975	E001052	E001117	E001185	E001255	E001319	E001386	E001462	E001527
E000976	E001053	E001118	E001186	E001256	E001320	E001387	E001464	E001528
E000977	E001054	E001120	E001187	E001257	E001321	E001388	E001466	E001529
E000978	E001055	E001121	E001188	E001258	E001322	E001390	E001467	E001530
E000979	E001056	E001122	E001189	E001259	E001323	E001391	E001468	E001531
E000982	E001057	E001123	E001190	E001263	E001324	E001392	E001469	E001533
E000983	E001058	E001125	E001191	E001264	E001325	E001393	E001470	E001534
E000984	E001059	E001126	E001192	E001265	E001326	E001394	E001471	E001535
E000985	E001061	E001127	E001193	E001266	E001327	E001397	E001472	E001536
E000986	E001062	E001129	E001194	E001267	E001328	E001399	E001473	E001537
E000988	E001063	E001130	E001196	E001268	E001329	E001400	E001474	E001538
E000989	E001065	E001131	E001197	E001269	E001330	E001401	E001476	E001539
E000990	E001066	E001132	E001198	E001270	E001331	E001402	E001477	E001540
E000995	E001067	E001133	E001199	E001271	E001332	E001405	E001478	E001541
E000996	E001068	E001134	E001200	E001272	E001333	E001406	E001479	E001542
E000999	E001069	E001136	E001201	E001273	E001334	E001407	E001480	E001543

Registreeringu number

E001544	E001608	E001671	E001732	E001796	E001860	E001922	E001984	E002046
E001545	E001610	E001672	E001733	E001797	E001862	E001923	E001985	E002047
E001546	E001611	E001674	E001734	E001798	E001863	E001924	E001986	E002048
E001547	E001612	E001675	E001735	E001799	E001865	E001925	E001987	E002049
E001550	E001613	E001676	E001736	E001800	E001866	E001926	E001988	E002050
E001551	E001614	E001677	E001739	E001801	E001867	E001927	E001989	E002051
E001552	E001615	E001678	E001740	E001802	E001868	E001928	E001990	E002052
E001553	E001616	E001679	E001741	E001803	E001870	E001929	E001991	E002053
E001554	E001617	E001680	E001742	E001804	E001871	E001930	E001992	E002054
E001555	E001618	E001681	E001743	E001805	E001872	E001931	E001993	E002055
E001557	E001619	E001682	E001744	E001806	E001873	E001932	E001994	E002056
E001559	E001620	E001683	E001745	E001807	E001874	E001933	E001995	E002058
E001560	E001621	E001684	E001746	E001808	E001875	E001934	E001996	E002059
E001561	E001622	E001685	E001747	E001809	E001876	E001935	E001997	E002060
E001562	E001623	E001686	E001748	E001810	E001877	E001936	E001998	E002061
E001563	E001624	E001687	E001749	E001811	E001878	E001937	E001999	E002062
E001564	E001625	E001688	E001750	E001812	E001879	E001938	E002000	E002063
E001566	E001626	E001689	E001751	E001813	E001880	E001939	E002001	E002064
E001567	E001627	E001690	E001752	E001814	E001882	E001940	E002002	E002065
E001568	E001628	E001691	E001753	E001815	E001883	E001941	E002003	E002066
E001569	E001629	E001692	E001755	E001816	E001884	E001942	E002004	E002067
E001570	E001631	E001693	E001756	E001817	E001885	E001943	E002005	E002068
E001571	E001632	E001694	E001757	E001818	E001886	E001944	E002006	E002069
E001572	E001633	E001695	E001758	E001819	E001887	E001945	E002008	E002070
E001573	E001634	E001696	E001759	E001820	E001888	E001946	E002009	E002071
E001574	E001635	E001697	E001760	E001821	E001889	E001947	E002010	E002072
E001575	E001637	E001698	E001761	E001822	E001890	E001948	E002011	E002073
E001576	E001639	E001699	E001762	E001824	E001891	E001949	E002012	E002074
E001577	E001640	E001700	E001764	E001825	E001892	E001950	E002013	E002075
E001578	E001641	E001701	E001765	E001827	E001893	E001951	E002014	E002076
E001579	E001642	E001702	E001767	E001828	E001894	E001952	E002015	E002077
E001580	E001643	E001703	E001768	E001829	E001895	E001953	E002016	E002078
E001581	E001644	E001704	E001769	E001830	E001896	E001954	E002017	E002079
E001582	E001645	E001705	E001770	E001832	E001897	E001955	E002018	E002080
E001583	E001646	E001706	E001771	E001833	E001898	E001956	E002019	E002081
E001584	E001647	E001707	E001772	E001834	E001899	E001957	E002020	E002082
E001585	E001648	E001708	E001773	E001835	E001900	E001958	E002021	E002083
E001587	E001650	E001709	E001774	E001836	E001901	E001959	E002022	E002084
E001588	E001651	E001710	E001775	E001837	E001902	E001960	E002023	E002085
E001589	E001652	E001711	E001776	E001838	E001903	E001962	E002024	E002086
E001590	E001653	E001713	E001777	E001839	E001904	E001963	E002025	E002087
E001591	E001654	E001714	E001778	E001840	E001905	E001964	E002026	E002088
E001592	E001655	E001715	E001779	E001841	E001906	E001966	E002027	E002089
E001593	E001656	E001716	E001781	E001842	E001907	E001967	E002028	E002090
E001594	E001657	E001717	E001782	E001843	E001908	E001969	E002029	E002091
E001595	E001658	E001718	E001783	E001844	E001909	E001970	E002031	E002092
E001596	E001659	E001719	E001784	E001846	E001910	E001971	E002032	E002094
E001597	E001660	E001721	E001785	E001847	E001911	E001972	E002033	E002095
E001598	E001661	E001722	E001786	E001848	E001912	E001973	E002034	E002096
E001599	E001662	E001723	E001787	E001849	E001913	E001974	E002035	E002097
E001600	E001663	E001724	E001788	E001851	E001914	E001976	E002036	E002098
E001601	E001664	E001725	E001789	E001852	E001915	E001977	E002038	E002099
E001602	E001665	E001726	E001790	E001853	E001916	E001978	E002039	E002100
E001603	E001666	E001727	E001791	E001854	E001917	E001979	E002040	E002102
E001604	E001667	E001728	E001792	E001856	E001918	E001980	E002041	E002103
E001605	E001668	E001729	E001793	E001857	E001919	E001981	E002043	E002104
E001606	E001669	E001730	E001794	E001858	E001920	E001982	E002044	E002105
E001607	E001670	E001731	E001795	E001859	E001921	E001983	E002045	E002106

Registreeringu number

E002107	E002170	E002232	E002294	E002353	E002416	E002476	E002536	E002596
E002109	E002172	E002233	E002295	E002355	E002417	E002477	E002537	E002597
E002110	E002173	E002234	E002296	E002356	E002418	E002478	E002538	E002598
E002111	E002174	E002235	E002297	E002357	E002419	E002480	E002539	E002599
E002113	E002175	E002236	E002298	E002358	E002420	E002481	E002540	E002600
E002114	E002176	E002237	E002299	E002360	E002421	E002482	E002541	E002601
E002115	E002177	E002238	E002300	E002361	E002422	E002483	E002542	E002602
E002116	E002178	E002239	E002301	E002362	E002423	E002484	E002543	E002603
E002117	E002179	E002240	E002302	E002363	E002424	E002485	E002544	E002604
E002118	E002180	E002241	E002303	E002364	E002425	E002486	E002545	E002605
E002119	E002181	E002242	E002304	E002365	E002426	E002487	E002546	E002606
E002120	E002184	E002243	E002305	E002366	E002427	E002488	E002547	E002607
E002121	E002185	E002244	E002306	E002367	E002428	E002489	E002548	E002608
E002122	E002186	E002245	E002307	E002368	E002429	E002490	E002549	E002609
E002123	E002187	E002246	E002308	E002369	E002430	E002491	E002550	E002610
E002124	E002188	E002247	E002309	E002370	E002431	E002492	E002552	E002611
E002125	E002189	E002248	E002310	E002371	E002432	E002493	E002553	E002612
E002126	E002190	E002249	E002311	E002372	E002433	E002494	E002554	E002614
E002127	E002191	E002250	E002312	E002373	E002434	E002495	E002555	E002615
E002128	E002192	E002251	E002313	E002374	E002435	E002496	E002556	E002616
E002129	E002193	E002252	E002314	E002375	E002436	E002497	E002557	E002617
E002130	E002194	E002253	E002315	E002376	E002437	E002498	E002558	E002618
E002132	E002195	E002255	E002316	E002377	E002438	E002499	E002559	E002619
E002133	E002196	E002256	E002317	E002378	E002439	E002500	E002560	E002620
E002134	E002197	E002257	E002318	E002379	E002441	E002501	E002561	E002621
E002135	E002198	E002258	E002319	E002381	E002442	E002502	E002562	E002622
E002136	E002199	E002259	E002320	E002382	E002443	E002503	E002563	E002623
E002137	E002200	E002260	E002321	E002383	E002444	E002504	E002564	E002624
E002138	E002201	E002261	E002322	E002384	E002445	E002505	E002565	E002625
E002140	E002202	E002262	E002323	E002385	E002446	E002506	E002566	E002626
E002141	E002203	E002263	E002324	E002386	E002447	E002507	E002567	E002627
E002142	E002204	E002264	E002325	E002387	E002448	E002508	E002568	E002628
E002143	E002205	E002265	E002326	E002388	E002449	E002509	E002569	E002629
E002144	E002206	E002266	E002327	E002389	E002450	E002510	E002570	E002630
E002145	E002207	E002267	E002328	E002390	E002451	E002512	E002571	E002631
E002146	E002208	E002268	E002329	E002391	E002452	E002513	E002572	E002632
E002147	E002209	E002269	E002330	E002392	E002453	E002514	E002573	E002633
E002148	E002210	E002270	E002331	E002393	E002454	E002515	E002574	E002634
E002149	E002211	E002271	E002332	E002394	E002455	E002516	E002575	E002635
E002150	E002212	E002272	E002333	E002395	E002456	E002517	E002576	E002636
E002151	E002213	E002273	E002334	E002396	E002458	E002518	E002577	E002637
E002152	E002214	E002274	E002335	E002397	E002459	E002519	E002578	E002638
E002153	E002215	E002275	E002336	E002398	E002460	E002520	E002579	E002639
E002154	E002217	E002276	E002337	E002400	E002461	E002521	E002580	E002640
E002155	E002218	E002277	E002338	E002401	E002462	E002522	E002581	E002641
E002156	E002219	E002278	E002339	E002402	E002463	E002523	E002582	E002642
E002157	E002220	E002279	E002340	E002403	E002464	E002524	E002583	E002643
E002158	E002221	E002282	E002341	E002404	E002465	E002525	E002584	E002644
E002159	E002222	E002283	E002342	E002405	E002466	E002526	E002585	E002645
E002160	E002223	E002284	E002343	E002406	E002467	E002527	E002586	E002646
E002161	E002224	E002285	E002344	E002407	E002468	E002528	E002587	E002647
E002162	E002225	E002286	E002346	E002408	E002469	E002529	E002588	E002649
E002163	E002226	E002287	E002347	E002409	E002470	E002530	E002589	E002650
E002164	E002227	E002289	E002348	E002410	E002471	E002531	E002591	E002651
E002166	E002228	E002290	E002349	E002412	E002472	E002532	E002592	E002652
E002167	E002229	E002291	E002350	E002413	E002473	E002533	E002593	E002653
E002168	E002230	E002292	E002351	E002414	E002474	E002534	E002594	E002654
E002169	E002231	E002293	E002352	E002415	E002475	E002535	E002595	E002655

Registreeringu number

E002656	E002716	E002776	E002836	E002896	E002957	E003016	E003075	E003134
E002657	E002717	E002777	E002837	E002897	E002958	E003017	E003076	E003135
E002658	E002718	E002778	E002838	E002898	E002959	E003018	E003077	E003136
E002659	E002719	E002779	E002839	E002899	E002960	E003019	E003078	E003137
E002660	E002720	E002780	E002840	E002900	E002961	E003020	E003079	E003138
E002661	E002721	E002781	E002841	E002901	E002962	E003021	E003080	E003139
E002662	E002722	E002782	E002842	E002902	E002963	E003022	E003081	E003140
E002663	E002723	E002783	E002843	E002903	E002964	E003023	E003082	E003141
E002664	E002724	E002784	E002844	E002904	E002965	E003024	E003083	E003142
E002665	E002726	E002785	E002845	E002905	E002966	E003025	E003084	E003143
E002666	E002727	E002787	E002846	E002906	E002967	E003026	E003085	E003144
E002667	E002728	E002788	E002847	E002907	E002968	E003027	E003086	E003145
E002669	E002729	E002789	E002848	E002908	E002969	E003028	E003087	E003146
E002670	E002730	E002790	E002849	E002909	E002970	E003029	E003088	E003147
E002671	E002731	E002791	E002850	E002910	E002971	E003030	E003089	E003148
E002672	E002732	E002792	E002851	E002911	E002972	E003031	E003090	E003149
E002673	E002733	E002793	E002852	E002912	E002973	E003032	E003091	E003150
E002674	E002734	E002794	E002853	E002913	E002974	E003033	E003092	E003151
E002675	E002735	E002795	E002854	E002914	E002975	E003034	E003093	E003152
E002676	E002736	E002796	E002855	E002915	E002976	E003035	E003094	E003153
E002677	E002737	E002797	E002856	E002916	E002977	E003036	E003095	E003154
E002678	E002738	E002798	E002857	E002917	E002978	E003037	E003096	E003155
E002679	E002739	E002799	E002858	E002918	E002979	E003038	E003097	E003156
E002680	E002740	E002800	E002859	E002919	E002980	E003039	E003098	E003157
E002681	E002741	E002801	E002860	E002920	E002981	E003040	E003099	E003158
E002682	E002742	E002802	E002861	E002921	E002982	E003041	E003100	E003159
E002683	E002743	E002803	E002862	E002922	E002983	E003042	E003101	E003160
E002684	E002744	E002804	E002863	E002923	E002984	E003043	E003102	E003161
E002685	E002745	E002805	E002864	E002924	E002985	E003044	E003103	E003162
E002686	E002746	E002806	E002865	E002925	E002986	E003045	E003104	E003163
E002687	E002747	E002807	E002866	E002926	E002987	E003046	E003105	E003164
E002688	E002748	E002808	E002867	E002927	E002988	E003047	E003106	E003165
E002689	E002749	E002809	E002868	E002928	E002989	E003048	E003107	E003166
E002690	E002750	E002810	E002870	E002929	E002990	E003049	E003108	E003167
E002691	E002751	E002811	E002871	E002930	E002991	E003050	E003109	E003168
E002692	E002752	E002812	E002872	E002931	E002992	E003051	E003110	E003169
E002693	E002753	E002813	E002873	E002932	E002993	E003052	E003111	E003170
E002694	E002754	E002814	E002874	E002933	E002994	E003053	E003112	E003171
E002695	E002755	E002815	E002875	E002934	E002995	E003054	E003113	E003172
E002696	E002756	E002816	E002876	E002935	E002996	E003055	E003114	E003173
E002697	E002757	E002817	E002877	E002936	E002997	E003056	E003115	E003174
E002698	E002758	E002818	E002878	E002937	E002998	E003057	E003116	E003175
E002699	E002759	E002819	E002879	E002938	E002999	E003058	E003117	E003176
E002700	E002760	E002820	E002880	E002940	E003000	E003059	E003118	E003177
E002701	E002761	E002821	E002881	E002941	E003001	E003060	E003119	E003178
E002702	E002762	E002822	E002882	E002942	E003002	E003061	E003120	E003179
E002703	E002763	E002823	E002883	E002944	E003003	E003062	E003121	E003180
E002704	E002764	E002824	E002884	E002945	E003004	E003063	E003122	E003181
E002705	E002765	E002825	E002885	E002946	E003005	E003064	E003123	E003182
E002706	E002766	E002826	E002886	E002947	E003006	E003065	E003124	E003183-
E002707	E002767	E002827	E002887	E002948	E003007	E003066	E003125	E003184
E002708	E002768	E002828	E002888	E002949	E003008	E003067	E003126	E003185
E002709	E002769	E002829	E002889	E002950	E003009	E003068	E003127	E003186
E002710	E002770	E002830	E002890	E002951	E003010	E003069	E003128	E003187
E002711	E002771	E002831	E002891	E002952	E003011	E003070	E003129	E003188
E002712	E002772	E002832	E002892	E002953	E003012	E003071	E003130	E003189
E002713	E002773	E002833	E002893	E002954	E003013	E003072	E003131	E003190
E002714	E002774	E002834	E002894	E002955	E003014	E003073	E003132	E003191
E002715	E002775	E002835	E002895	E002956	E003015	E003074	E003133	E003192

Registreeringu number

E003193	E003254	E003314	E003374	E003434	E003494	E003554	E003614	E003674
E003194	E003255	E003315	E003375	E003435	E003495	E003555	E003615	E003675
E003195	E003256	E003316	E003376	E003436	E003496	E003556	E003616	E003676
E003196	E003257	E003317	E003377	E003437	E003497	E003557	E003617	E003677
E003197	E003258	E003318	E003378	E003438	E003498	E003558	E003618	E003678
E003198	E003259	E003319	E003379	E003439	E003499	E003559	E003619	E003679
E003199	E003260	E003320	E003380	E003440	E003500	E003560	E003620	E003680
E003200	E003261	E003321	E003381	E003441	E003501	E003561	E003621	E003681
E003201	E003262	E003322	E003382	E003442	E003502	E003562	E003622	E003682
E003202	E003263	E003323	E003383	E003443	E003503	E003563	E003623	E003683
E003204	E003264	E003324	E003384	E003444	E003504	E003564	E003624	E003684
E003205	E003265	E003325	E003385	E003445	E003505	E003565	E003625	E003685
E003206	E003266	E003326	E003386	E003446	E003506	E003566	E003626	E003686
E003207	E003267	E003327	E003387	E003447	E003507	E003567	E003627	E003687
E003208	E003268	E003328	E003388	E003448	E003508	E003568	E003628	E003688
E003209	E003269	E003329	E003389	E003449	E003509	E003569	E003629	E003689
E003210	E003270	E003330	E003390	E003450	E003510	E003570	E003630	E003690
E003211	E003271	E003331	E003391	E003451	E003511	E003571	E003631	E003691
E003212	E003272	E003332	E003392	E003452	E003512	E003572	E003632	E003692
E003213	E003273	E003333	E003393	E003453	E003513	E003573	E003633	E003693
E003214	E003274	E003334	E003394	E003454	E003514	E003574	E003634	E003694
E003215	E003275	E003335	E003395	E003455	E003515	E003575	E003635	E003695
E003216	E003276	E003336	E003396	E003456	E003516	E003576	E003636	E003696
E003217	E003277	E003337	E003397	E003457	E003517	E003577	E003637	E003697
E003218	E003278	E003338	E003398	E003458	E003518	E003578	E003638	E003698
E003219	E003279	E003339	E003399	E003459	E003519	E003579	E003639	E003699
E003220	E003280	E003340	E003400	E003460	E003520	E003580	E003640	E003700
E003221	E003281	E003341	E003401	E003461	E003521	E003581	E003641	E003701
E003222	E003282	E003342	E003402	E003462	E003522	E003582	E003642	E003702
E003223	E003283	E003343	E003403	E003463	E003523	E003583	E003643	E003703
E003224	E003284	E003344	E003404	E003464	E003524	E003584	E003644	E003704
E003225	E003285	E003345	E003405	E003465	E003525	E003585	E003645	E003705
E003226	E003286	E003346	E003406	E003466	E003526	E003586	E003646	E003706
E003227	E003287	E003347	E003407	E003467	E003527	E003587	E003647	E003707
E003228	E003288	E003348	E003408	E003468	E003528	E003588	E003648	E003708
E003229	E003289	E003349	E003409	E003469	E003529	E003589	E003649	E003709
E003230	E003290	E003350	E003410	E003470	E003530	E003590	E003650	E003710
E003231	E003291	E003351	E003411	E003471	E003531	E003591	E003651	E003711
E003232	E003292	E003352	E003412	E003472	E003532	E003592	E003652	E003712
E003233	E003293	E003353	E003413	E003473	E003533	E003593	E003653	E003713
E003234	E003294	E003354	E003414	E003474	E003534	E003594	E003654	E003714
E003235	E003295	E003355	E003415	E003475	E003535	E003595	E003655	E003715
E003236	E003296	E003356	E003416	E003476	E003536	E003596	E003656	E003716
E003237	E003297	E003357	E003417	E003477	E003537	E003597	E003657	E003717
E003238	E003298	E003358	E003418	E003478	E003538	E003598	E003658	E003718
E003239	E003299	E003359	E003419	E003479	E003539	E003599	E003659	E003719
E003240	E003300	E003360	E003420	E003480	E003540	E003600	E003660	E003720
E003241	E003301	E003361	E003421	E003481	E003541	E003601	E003661	E003721
E003242	E003302	E003362	E003422	E003482	E003542	E003602	E003662	E003722
E003243	E003303	E003363	E003423	E003483	E003543	E003603	E003663	E003723
E003244	E003304	E003364	E003424	E003484	E003544	E003604	E003664	E003724
E003245	E003305	E003365	E003425	E003485	E003545	E003605	E003665	E003725
E003246	E003306	E003366	E003426	E003486	E003546	E003606	E003666	
E003247	E003307	E003367	E003427	E003487	E003547	E003607	E003667	
E003248	E003308	E003368	E003428	E003488	E003548	E003608	E003668	
E003249	E003309	E003369	E003429	E003489	E003549	E003609	E003669	
E003250	E003310	E003370	E003430	E003490	E003550	E003610	E003670	
E003251	E003311	E003371	E003431	E003491	E003551	E003611	E003671	
E003252	E003312	E003372	E003432	E003492	E003552	E003612	E003672	
E003253	E003313	E003373	E003433	E003493	E003553	E003613	E003673	

**ND1Y. KEHTIVATE TÄIENDAVA KAITSE SAANUD MEDITSIINITOODETE
TUNNISTUSTE NUMBRILINE LOEND
SEISUGA 31.12.2009**

Tunnistuse number

00001	00011	00020
00002	00012	00021
00003	00013	00022
00004	00014	00023
00005	00015	00024
00006	00016	00025
00007	00017	00026
00008	00018	
00010	00019	

VI OSA. PATENDIALASED ÕIGUSAKTID JA MUU INFO

RIIKLIKUS PATENDIVOLINIKE REGISTRIS REGISTREERITUD PATENDIVOLINIKE NIMEKIRI (seisuga 29. detsember 2009)

Register on asutatud 1. septembril 2001. a Vabariigi Valitsuse 7. augusti 2001. a määrusega nr 271 "Riikliku patendivolinike registri asutamine ja registri pidamise põhimäärus" (RT I 2001, 70, 426) patendivoliniku seaduse § 21 alusel (RT I 2001, 27, 151).

TEGEVUSVALDKOND: LEIUTIS (PATENT, KASULIK MUDEL), MIKROLÜLITUSTE TOPOLOOGIA

Arno ANIJALG	Patendibüroo Ustervall OÜ Kivi 21-6 51009 Tartu telefon: 744 1980 telefaks: 744 1785 e-post: anijalg@ustervall.ee http://www.ustervall.ee võõrkeeled: saksa, vene	Lembit KALEV	Patendibüroo ROOSILLA OÜ Järveotsa tee 39-61 13520 Tallinn telefon: 657 5381 telefaks: 657 5381 GSM: 511 9951 e-post: roosilla@roosilla.ee http://www.roosilla.ee võõrkeeled: inglise, vene
Alla HÄMMALOV	OÜ Intels Magasini 12 51005 Tartu telefon: 742 0401 telefaks: 742 0326 e-post: intels@intels.ee http://www.intels.ee võõrkeeled: inglise, poola, vene	Urmas KAULER	Patendibüroo TURVAJA OÜ Liivalaia 22 10118 Tallinn telefon: 640 3109 telefaks: 640 3105 e-post: turvaja@turvaja.ee http://www.turvaja.ee võõrkeeled: inglise, vene, soome
Juhan HÄMMALOV	OÜ Intels Magasini 12 51005 Tartu telefon: 742 0401 telefaks: 742 0326 e-post: intels@intels.ee http://www.intels.ee võõrkeeled: inglise, saksa, vene	Urmas KERNU	AAA Patendibüroo OÜ Tartu mnt 16 10117 Tallinn pk 3926, 10509 Tallinn telefon: 660 5910, 660 5911 telefaks: 660 5912 e-post: aaa@aaa.ee http://www.aaa.ee võõrkeeled: inglise, saksa, soome, vene
Uno JÄÄGER	Inseneribüroo Uneko OÜ Rüütli 51a, 80010 Pärnu telefon: 447 1021 telefaks: 447 1001 GSM: 515 1844 e-post: info@uneko.ee http://www.uneko.ee võõrkeeled: inglise, soome, vene	Ljubov KESSELMAN	OÜ Kesna Tedre 77-52 10616 Tallinn telefon: 660 8068 telefaks: 660 8069 e-post: kesna@kesna.ee http://www.kesna.ee võõrkeeled: inglise, vene
Sirje KAHU	Patendibüroo Ustervall OÜ Kivi 21-6 51009 Tartu telefon: 744 1980 telefaks: 744 1785 e-post: skahu@ustervall.ee http://www.ustervall.ee võõrkeeled: inglise, vene	Heinu KOITEL	Patendi- & Kaubamärgibüroo Koitel OÜ Tartu mnt 65 10115 Tallinn pk 1759, 10902 Tallinn telefon: 603 3260 telefaks: 603 3261 e-post: koitel@koitel.ee http://www.koitel.ee võõrkeeled: inglise, soome, vene

- Raivo KOITEL** **Patendi- & Kaubamärgibüroo Koitel OÜ**
Tartu mnt 65
10115 Tallinn
pk 1759, 10902 Tallinn
telefon: 603 3260
telefaks: 603 3261
e-post: koitel@koitel.ee
<http://www.koitel.ee>
võõrkeeled: vene, inglise, soome
- Mart Enn KOPPEL** **Patendibüroo Koppel OÜ**
Kajaka 4-10
11317 Tallinn
telefon: 677 4136
telefaks: 677 4138
e-post: info@koppelpb.com
<http://www.koppelpb.com>
võõrkeeled: inglise, vene, soome
- Jüri KÄOSAAR** **Patendibüroo Käosaar & Co OÜ**
Tähe 94
50107 Tartu
telefon: 738 3051
telefaks: 738 3055
e-post: info@kaosaar.ee
<http://www.kaosaar.ee>
võõrkeeled: inglise, vene
- Reet MAASIKAMÄE** **OÜ Kaitsepurus**
Mulla 4-3
10611 Tallinn
telefon: 673 9097, 633 2798
telefaks: 677 4844
e-post: purus@hot.ee
kaitsepurus@hot.ee
<http://www.hot.ee/purus/>
võõrkeeled: inglise, vene
- Leevi MARKUS** **Patendibüroo Käosaar & Co OÜ**
Tähe 94, 50107 Tartu
telefon: 738 3051
telefaks: 738 3055
e-post: info@kaosaar.ee
<http://www.kaosaar.ee>
võõrkeeled: inglise, vene
- Raivo MATSOO** **RM Hirvela Patendibüroo OÜ**
Saku 15, 11314 Tallinn
telefon: 614 0816
telefaks: 614 0818
e-post: hirvela@hirvela.ee
võõrkeeled: inglise, vene
- Anniki MEISTER** **Patendibüroo Koppel OÜ**
Kajaka 4-10
11317 Tallinn
telefon: 677 4136
5399 7106
telefaks: 677 4138
e-post: info@koppelpb.com
<http://www.koppelpb.com>
võõrkeeled: inglise, saksa vene, soome
- Elle MELLIK** **AAA Patendibüroo OÜ**
Tartu mnt 16
10117 Tallinn
pk 3926, 10509 Tallinn
telefon: 660 5910, 660 5911
telefaks: 660 5912
e-post: aaa@aaa.ee
<http://www.aaa.ee>
võõrkeeled: inglise, vene
- Lembit MITT** **AAA Patendibüroo OÜ**
Tartu mnt 16
10117 Tallinn
pk 3926, 10509 Tallinn
telefon: 660 5910, 660 5911
telefaks: 660 5912
e-post: aaa@aaa.ee
<http://www.aaa.ee>
võõrkeeled: inglise, vene
- Ott MOORLAT** **OÜ Moorlat & Ko Patendibüroo**
pk 723, 12902 Tallinn
telefon: 655 0450, 654 2844
telefaks: 654 2844
e-post: ott.moorlat@moorlat.ee
<http://www.moorlat.ee>
võõrkeeled: inglise, vene
- Andres MUTT** **OÜ LASVET**
Suurtüki 4a, 10133 Tallinn
pk 3136, 10505 Tallinn
telefon: 640 6600
telefaks: 640 6604
e-post: lasvet@lasvet.ee
<http://www.lasvet.ee>
võõrkeeled: vene, inglise
- Tõnu NELAS** **AAA Patendibüroo OÜ**
Tartu mnt 16
10117 Tallinn
pk 3926, 10509 Tallinn
telefon: 660 5910, 660 5911
telefaks: 660 5912
e-post: aaa@aaa.ee
<http://www.aaa.ee>
võõrkeeled: inglise, vene, soome

Piret NIIDAS	OÜ LASVET Suurtüki 4a, 10133 Tallinn pk 3136, 10505 Tallinn telefon: 640 6600 telefaks: 640 6604 e-post: lasvet@lasvet.ee http://www.lasvet.ee võõrkeeled: vene, saksa, inglise	Mikk PUTK	Sarap ja Partnerid Patendibüroo Akadeemia tee 19, 12618 Tallinn telefon: 6838 020 telefaks: 6838 001 e-post: mikk.putk@patent.ee http://www.patent.ee Skype ID: mikkputk võõrkeeled: inglise, vene
Jüri OLT	Danteks OÜ Tiigi 6, 51003 Tartu telefon: 508 1671 telefaks: 730 2844 e-post: jyri@danteks.net http://www.danteks.net võõrkeeled: inglise, saksa, soome, vene	Tarmo ROSMAN	Rosman ja Partnerid OÜ pk 652, 12602 Tallinn telefon: 656 1450 telefaks: 656 1450 e-post: tarman@cc.ttu.ee võõrkeeled: saksa, inglise, ungari, vene
Jaak OSTRAT	OÜ LASVET Suurtüki 4a, 10133 Tallinn pk 3136, 10505 Tallinn telefon: 640 6600 telefaks: 640 6604 e-post: lasvet@lasvet.ee http://www.lasvet.ee võõrkeeled: inglise, saksa, soome, vene	Arvo SALUMÄE	OÜ Amende Patendibüroo J. Köleri 8 10150 Tallinn telefon: 648 6125 telefaks: 641 0174 e-post: amende@hotmail.ee võõrkeeled: inglise, saksa, soome, vene
Tauno OTTO	Tallinna Tehnikaülikool Ehitajate tee 5, 19086 Tallinn telefon: 620 3269 telefaks: 620 2020 e-post: tauno.otto@ttu.ee http://www.ttu.ee võõrkeeled: inglise, vene	Margus SARAP	Sarap ja Partnerid Patendibüroo Riia 185A 51014 Tartu telefon: 747 7058 telefaks: 747 7059 e-post: margus.sarap@mail.ee võõrkeeled: inglise, vene
Villu PAVELTS	OÜ LASVET Suurtüki 4a, 10133 Tallinn pk 3136, 10505 Tallinn telefon: 640 6600 telefaks: 640 6604 e-post: lasvet@lasvet.ee http://www.lasvet.ee võõrkeeled: inglise, soome, vene	Tiina SIIM	OÜ LASVET Suurtüki 4a, 10133 Tallinn pk 3136, 10505 Tallinn telefon: 640 6600 telefaks: 640 6604 e-post: lasvet@lasvet.ee http://www.lasvet.ee võõrkeeled: inglise, vene
Riho PIKKOR	Patendibüroo TURVAJA OÜ Liivalaia 22 10118 Tallinn telefon: 640 3109 telefaks: 640 3105 e-post: turvaja@turvaja.ee http://www.turvaja.ee võõrkeeled: inglise, saksa, vene	Harald TEHVER	Patendibüroo TURVAJA OÜ Liivalaia 22 10118 Tallinn telefon: 640 3109 telefaks: 640 3105 e-post: turvaja@turvaja.ee http://www.turvaja.ee võõrkeeled: inglise, saksa, vene
Toom PUNGAS	OÜ Synest pk 977, 13402 Tallinn telefon: 660 9786 telefaks: 660 9787 e-post: toom@synest.ee võõrkeeled: inglise, saksa, soome, vene	Jürgen TOOME	OÜ LASVET Suurtüki 4a, 10133 Tallinn pk 3136, 10505 Tallinn telefon: 640 6600 telefaks: 640 6604 e-post: lasvet@lasvet.ee http://www.lasvet.ee võõrkeeled: inglise, vene

Olga TREUFELDT**Patendibüroo TURVAJA OÜ**

Liivalaia 22
10118 Tallinn
telefon: 640 3109
telefaks: 640 3105
e-post: turvaja@turvaja.ee
<http://www.turvaja.ee>
võõrkeeled: inglise, vene

Juta-Maris UUSTALU**OÜ Amende Patendibüroo**

J. Köleri 8
10150 Tallinn
telefon: 648 6125
telefaks: 641 0174
e-post: amende@hot.ee
võõrkeeled: inglise, vene

Enn URGAS**Patendibüroo TURVAJA OÜ**

Liivalaia 22
10118 Tallinn
telefon: 640 3109
telefaks: 640 3105
e-post: turvaja@turvaja.ee
<http://www.turvaja.ee>
võõrkeeled: inglise, vene

**LIST OF PATENT ATTORNEYS, REGISTERED IN
THE ESTONIAN STATE REGISTER OF PATENT ATTORNEYS**
(by 29 December 2009)

Register is established on September 1st 2001

FIELD OF ACTIVITY: INVENTION (PATENT, UTILITY MODEL), INTEGRATED CIRCUITS

Arno ANIJALG	Patendibüroo Ustervall OÜ Kivi 21-6 51009 Tartu, Estonia Phone: +372 744 1980 Fax: +372 744 1785 E-mail: anijalg@ustervall.ee Http://www.ustervall.ee German, Russian, Estonian	Lembit KALEV	Patent Bureau ROOSILLA Ltd. Järveotsa Road 39-61 13520 Tallinn, Estonia Phone: +372 657 5381 Fax: +372 657 5381 GSM: +372 511 9951 E-mail: roosilla@roosilla.ee Http://www.roosilla.ee English, Russian, Estonian
Alla HÄMMALOV	Intels Ltd. Magasini 12 51005 Tartu, Estonia Phone: +372 742 0401 Fax: +372 742 0326 E-mail: intels@intels.ee Http://www.intels.ee English, Polish, Russian, Estonian	Urmas KAULER	Patendibüroo TURVAJA OÜ Liivalaia 22 10118 Tallinn, Estonia Phone: +372 640 3109 Fax: +372 640 3105 E-mail: turvaja@turvaja.ee Http://www.turvaja.ee English, Russian, Finnish, Estonian
Juhan HÄMMALOV	Intels Ltd. Magasini 12 51005 Tartu, Estonia Phone: +372 742 0401 Fax: +372 742 0326 E-mail: intels@intels.ee Http://www.intels.ee English, German, Russian, Estonian	Urmas KERNU	AAA Legal Services Tartu Road 16 10117 Tallinn, Estonia P.O. Box 3926 10509 Tallinn, Estonia Phone: +372 660 5910 +372 660 5911 Fax: +372 660 5912 E-mail: aaa@aaa.ee Http://www.aaa.ee English, German, Finnish, Russian, Estonian
Uno JÄÄGER	Inseneribüroo Uneko Ltd. Rüütli 51a 80010 Pärnu, Estonia Phone: +372 447 1021 Fax: +372 447 1001 GSM: +372 515 1844 E-mail: info@uneko.ee Http://www.uneko.ee English, Finnish, Russian, Estonian	Ljubov KESSELMAN	Kesna Ltd. Tedre Str. 77-52 10616 Tallinn, Estonia Phone: +372 660 8068 Fax: +372 660 8069 E-mail: kesna@kesna.ee Http://www.kesna.ee English, Russian, Estonian
Sirje KAHU	Patendibüroo Ustervall OÜ Kivi 21-6 51009 Tartu, Estonia Phone: +372 744 1980 Fax: +372 744 1785 E-mail: skahu@ustervall.ee Http://www.ustervall.ee English, Russian, Estonian	Mart Enn KOPPEL	Patent Bureau Koppel Kajaka 4-10 11317 Tallinn, Estonia Phone: +372 677 4136 Fax: +372 677 4138 E-mail: info@koppelpb.com Http://www.koppelpb.com English, Russian, Finnish, Estonian

- Heinu KOITEL** **Patent & Trademark Agency Koitel**
Tartu Road 65
10115 Tallinn, Estonia
P.O. Box 1759
10902 Tallinn, Estonia
Phone: +372 603 3260
Fax: +372 603 3261
E-mail: koitel@koitel.ee
Http://www.koitel.ee
English, Finnish, Russian, Estonian
- Raivo KOITEL** **Patent & Trademark Agency Koitel**
Tartu Road 65
10115 Tallinn, Estonia
P.O. Box 1759
10902 Tallinn, Estonia
Phone: +372 603 3260
Fax: +372 603 3261
E-mail: koitel@koitel.ee
Http://www.koitel.ee
Russian, English, Finnish, Estonian
- Jüri KÄOSAAR** **Patent Agency Käosaar & Co**
Tähe Str. 94
50107 Tartu, Estonia
Phone: +372 738 3051
Fax: +372 738 3055
E-mail: info@kaosaar.ee
Http://www.kaosaar.ee
English, Russian, Estonian
- Reet MAASIKAMÄE** **Patent Bureau Kaitsepurus Ltd.**
Mulla Str. 4-3
10611 Tallinn, Estonia
Phone: +372 673 9097
+372 633 2798
Fax: +372 677 4844
E-mail: purus@hot.ee
kaitsepurus@hot.ee
Http://www.hot.ee/purus/
English, Russian, Estonian
- Leevi MARKUS** **Patent Agency Käosaar & Co**
Tähe Str. 94
50107 Tartu, Estonia
Phone: +372 738 3051
Fax: +372 738 3055
E-mail: info@kaosaar.ee
Http://www.kaosaar.ee
English, Russian, Estonian
- Raivo MATSOO**
- Anniki MEISTER**
- Elle MELLIK**
- Lembit MITT**
- Ott MOORLAT**
- Andres MUTT**
- RM Hirvela Patent Bureau Ltd**
Saku 15, 11314 Tallinn, Estonia
Phone: +372 614 0816
Fax: +372 614 0818
E-mail: hirvela@hirvela.ee
English, Russian, Estonian
- Patent Bureau Koppel**
Kajaka 4-10
11317 Tallinn, Estonia
Phone: +372 677 4136
+372 5399 7106
Fax: +372 677 4138
E-mail: info@koppelpb.com
Http://www.koppelpb.com
English, German, Russian, Finnish, Estonian
- AAA Legal Services**
Tartu Road 16
10117 Tallinn, Estonia
P.O. Box 3926
10509 Tallinn, Estonia
Phone: +372 660 5910
+372 660 5911
Fax: +372 660 5912
E-mail: aaa@aaa.ee
Http://www.aaa.ee
English, Russian, Estonian
- AAA Legal Services**
Tartu Road 16
10117 Tallinn, Estonia
P.O. Box 3926
10509 Tallinn, Estonia
Phone: +372 660 5910
+372 660 5911
Fax: +372 660 5912
E-mail: aaa@aaa.ee
Http://www.aaa.ee
English, Russian, Estonian
- Moorlat & Co Ltd. Patent Bureau**
P.O. Box 723
12902 Tallinn, Estonia
Phone: +372 655 0450
+372 654 2844
Fax: +372 654 2844
E-mail: ott.moorlat@moorlat.ee
Http://www.moorlat.ee
English, Russian, Estonian
- Lasvet Ltd.**
P.O. Box 3136
10505 Tallinn, Estonia
Phone: +372 640 6600
Fax: +372 640 6604
E-mail: lasvet@lasvet.ee
Http://www.lasvet.ee
Russian, English, Estonian

Tõnu NELNAS	AAA Legal Services Tartu Road 16 10117 Tallinn, Estonia P.O. Box 3926 10509 Tallinn, Estonia Phone: +372 660 5910 +372 660 5911 Fax: +372 660 5912 E-mail: aaa@aaa.ee Http://www.aaa.ee English, Russian, Finnish, Estonian	Riho PIKKOR	Patendibüroo TURVAJA OÜ Liivalaia 22 10118 Tallinn, Estonia Phone: +372 640 3109 Fax: +372 640 3105 E-mail: turvaja@turvaja.ee Http://www.turvaja.ee English, German, Russian, Estonian
Piret NIIDAS	Lasvet Ltd. P.O. Box 3136 10505 Tallinn, Estonia Phone: +372 640 6600 Fax: +372 640 6604 E-mail: lasvet@lasvet.ee Http://www.lasvet.ee Russian, German, English, Estonian	Toom PUNGAS	Synest Ltd. P.O. Box 977 13402 Tallinn, Estonia Phone: +372 660 9786 Fax: +372 660 9787 E-mail: toom@synest.ee English, German, Finnish, Russian, Estonian
Jüri OLT	Danteks OÜ Tiigi 6 51003 Tartu, Estonia Phone: +372 508 1671 Fax: +372 730 2844 E-mail: jyri@danteks.net Http://www.danteks.net English, German, Finnish, Russian, Estonian	Mikk PUTK	Sarap ja Partnerid Patendibüroo Akadeemia tee 19 12618 Tallinn, Estonia Phone: +372 6838 020 Fax: +372 6838 001 E-mail: mikk.putk@patent.ee Http://www.patent.ee Skype ID: mikkputk English, Russian, Estonian
Jaak OSTRAT	Lasvet Ltd. P.O. Box 3136 10505 Tallinn, Estonia Phone: +372 640 6600 Fax: +372 640 6604 E-mail: lasvet@lasvet.ee Http://www.lasvet.ee English, German, Finnish, Russian, Estonian	Tarmo ROSMAN	Rosman and Partners Ltd. P.O. Box 652 12602 Tallinn, Estonia Phone: +372 656 1450 Fax: +372 656 1450 E-mail: tarman@cc.ttu.ee German, English, Hungarian, Russian, Estonian
Tauno OTTO	Tallinn University of Technology Ehitajate tee 5 19086 Tallinn, Estonia Phone: +372 620 3269 Fax: +372 620 2020 E-mail: tauno.otto@ttu.ee Http://www.ttu.ee English, Russian, Estonian	Arvo SALUMÄE	AMENDE Patent Agency Ltd. J. Köleri 8, 10150 Tallinn, Estonia Phone: +372 648 6125 Fax: +372 641 0174 E-mail: amende@hotmail.ee English, German, Finnish, Russian, Estonian
Villu PAVELTS	Lasvet Ltd. P.O. Box 3136 10505 Tallinn, Estonia Phone: +372 640 6600 Fax: +372 640 6604 E-mail: lasvet@lasvet.ee Http://www.lasvet.ee English, Finnish, Russian, Estonian	Margus SARAP	Sarap ja Partnerid Patendibüroo Riia 185A 51014 Tartu, Estonia Phone: +372 747 7058 Fax: +372 747 7059 E-mail: margus.sarap@mail.ee English, Russian, Estonian

Tiina SIIM

Lasvet Ltd.
P.O. Box 3136
10505 Tallinn, Estonia
Phone: +372 640 6600
Fax: +372 640 6604
E-mail: lasvet@lasvet.ee
Http://www.lasvet.ee
English, Russian, Estonian

Olga TREUFELDT

Patendibüroo TURVAJA OÜ
Liivalaia 22
10118 Tallinn, Estonia
Phone: +372 640 3109
Fax: +372 640 3105
E-mail: turvaja@turvaja.ee
Http://www.turvaja.ee
English, Russian, Estonian

Harald TEHVER

Patendibüroo TURVAJA OÜ
Liivalaia 22
10118 Tallinn, Estonia
Phone: +372 640 3109
Fax: +372 640 3105
E-mail: turvaja@turvaja.ee
Http://www.turvaja.ee
English, German, Russian,
Estonian

Enn URGAS

Patendibüroo TURVAJA OÜ
Liivalaia 22
10118 Tallinn, Estonia
Phone: +372 640 3109
Fax: +372 640 3105
E-mail: turvaja@turvaja.ee
Http://www.turvaja.ee
English, Russian, Estonian

Jürgen TOOME

Lasvet Ltd.
P.O. Box 3136
10505 Tallinn, Estonia
Phone: +372 640 6600
Fax: +372 640 6604
E-mail: lasvet@lasvet.ee
Http://www.lasvet.ee
English, Russian, Estonian

Juta-Maris UUSTALU

AMENDE Patent Agency Ltd.
J. Köleri 8, 10150 Tallinn,
Estonia
Phone: +372 648 6125
Fax: +372 641 0174
E-mail: amende@hot.ee
English, Russian, Estonian