

CENTRE FOR NONLINEAR STUDIES

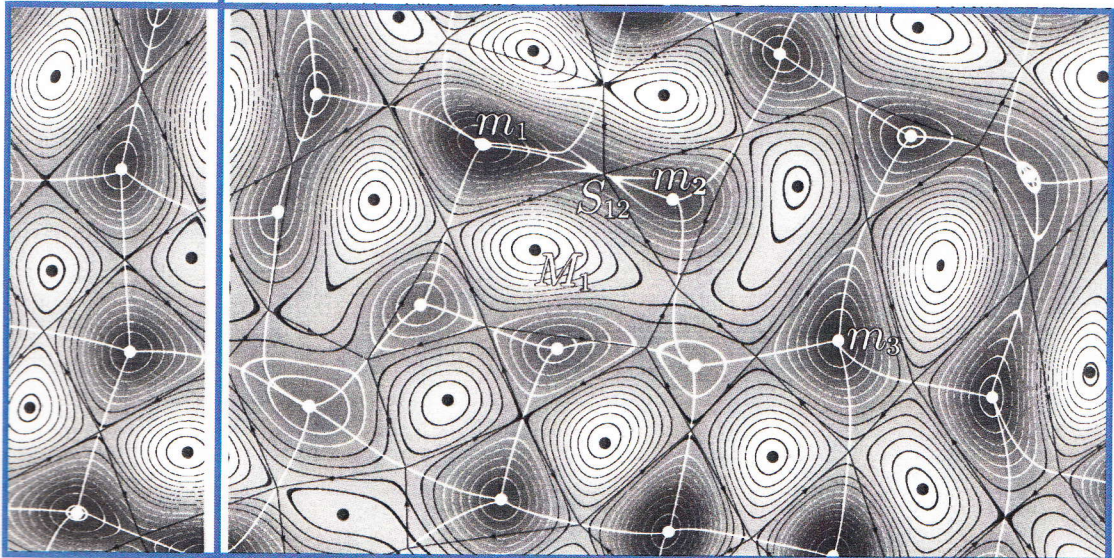

2015 ANNUAL REPORT

Tallinn



Institute of Cybernetics at Tallinn University of Technology
Institute of Physics, University of Tartu



CENS

Centre for Nonlinear Studies
Estonian Centre of Excellence in Research

Annual Report

2015 Tallinn

Contents

1. Introduction
 2. Overview on CENS
 3. Current results 2015
 4. Funding
 5. Publicity of results
 6. Research and teaching activities
 7. Summary
- Annex

Abstract

This Report gives a brief overview on activities of CENS in 2015. In 2011–2015 CENS was an Estonian Centre of Excellence in Research, supported by the European Regional Fund. Described are research highlights of 2015 and more detailed results summarised by research groups: (i) nonlinear dynamics: waves in solids, inverse problems, photoelasticity, fractality and econophysics; (ii) wave engineering: waves on sea and coastal engineering; (iii) systems biology: cell energetics; (iv) optics: light pulses; (v) nonlinear control theory: algorithms and software.

The full records of published papers, reports, conference talks, teaching activities, promotions, etc are included together with list of science-popular articles and public talks. The Annex includes the opinion of the IAB on activities of CENS.

Keywords: nonlinear dynamics, soft matter physics, microstructured solids, solitons, acoustodiagnosics, photoelasticity, cell energetics, water waves, extreme waves, coastal engineering, differential equations, control theory, wave optics and localised waves.

The International Advisory Board

Prof. F. Allgöwer, University of Stuttgart; Prof. S. Bishop, University College London;
Prof. R. Grimshaw, Loughborough University; Dr. R. Grunwald, Max-Born-Institute, Berlin;
Prof. G. Holzapfel, Graz University of Technology; Prof. G.A. Maugin, University of Paris 6;
Prof. F. Pastrone, University of Turin; Prof. G. Stepan, Budapest University of Technology and Economics.

Sisukord

1. Sissejuhatus
2. Ülevaade CENSist
3. Põhitulemused 2015
4. Finantseerimine
5. Publikatsioonid, konverentsid
6. Tegevus ja õppetöö
7. Kokkuvõte

Lisa

Lühikokkuvõte

Aruanne sisaldab ülevaadet CENSi (Mittelineaarsete Protsesside Analüüsi Keskuse) tegevusest 2015. a. CENS oli 2011 – 2015 a. Eesti teaduse tippkeskus, millega kaasneb toetus Euroopa Regionaalarengu Fondilt. Esitatud on ülevaade parimatest tulemustest 2015 a ja põhitulemused uurimisgruppide kaupa: (i) mittelineaarne dünaamika: lained tahkistes, pöördülesanded, fotoelastsus, fraktaalsus ja ökonofüüsika; (ii) lainetuse dünaamika: lained veepinnal ja rannikutehnika; (iii) süsteemibioloogia: rakuenergeetika; (iv) optika: lokaliseeritud valguslained; (v) juhtimissüsteemid: teooria, algoritmid ja tarkvara.

On esitatud publikatsioonide, konverentsiettekannete, seminaride ja õppekursuste jm. nimekirjad, samuti populaarteaduslike artiklite ja esinemiste nimekirjad. Lisas on täiendav informatsioon.

Võtmesõnad:

mittelineaarne dünaamika, pehmisefüüsika, mikrostruktuuriga materjalid, solitonid, akustodiagnostika, fotoelastsus, rakuenergeetika, pinnalained, hiidlained, rannikutehnika, diferentsiaalvõrrandid, juhtimisteooria, laineoptika, lokaliseeritud lained.

1. Introduction

The underlying idea for founding Centre for Nonlinear Studies (CENS) in 1999 was to bring together the scientific potential of Estonia engaged in interdisciplinary studies of complex nonlinear processes. The essential milestones of CENS are the following. In 2002–2007, CENS was included into the first Estonian National Programme for Centres of Excellence in Research. The results from this period are described in "CENS Highlights 2003–2007". In 2009, CENS was awarded with the title "Centre of Excellence in Research of Tallinn University of Technology for years 2009–2011. In 2011, CENS was included into the second Estonian National Programme for Centres of Excellence in Research (2011–2015). The Annual Reports (<http://cens.ioc.ee>) describe the results and activities of CENS in detail.

This Report covers, like the previous ones, all the results and activities of CENS in the current year 2015. Section 2 is a short summary on the structure of CENS and on highlights 2015. In Section 3, current research results in 2015 are described in more detail. Next sections describe funding (Section 4), publications, conferences, etc (Section 5) and other additional activities of CENS (Section 6). Finally, in Section 7, conclusions and perspectives are presented. The Annex includes some additional materials.

2. Overview on CENS and highlights in 2015

CENS is the Estonian hub of competence, research and training into nonlinear phenomena – the intrinsic component of real world that brings in universal phenomena (solitons, coherence, chaos, hierarchies, self-emergence, etc) which need specific tools for their analysis and control. As before, CENS includes four research groups from the Institute of Cybernetics (IoC) at Tallinn University of Technology (TUT) and one group from the University of Tartu (UT). The structure of CENS is:

Nonlinear Dynamics (IoC at TUT) — Prof J.Kalda;
together with the *Laboratory of Photoelasticity* — Dr J. Anton;
Wave Engineering (IoC at TUT) — Prof T.Soomere;
Systems Biology (IoC at TUT) — Dr M.Vendelin;
Optics (UT) — Prof P.Saari;
Nonlinear Control Theory (IoC at TUT) — Dr Ü.Kotta.

The Head of CENS is Prof J.Engelbrecht.

The competences of research groups are described in previous reports and not repeated here. Synergy and added value is created by the analysis of universal nonlinear phenomena: mathematical models and methods of analysis; interaction of waves and fields in a wide range of scales, solitons, solitary waves and localized waves: emerging features; nonlinear feedback, irreversibility; control over physical phenomena, etc. Such studies are in the forefront of science, more specifically, in studies of complex systems. CENS has research personnel of 60, of whom 21 are PhD students (see Annex 4).

Highlights of research in 2015

Nonlinear Dynamics

- A novel governing equation for describing mechanical waves in biomembranes is derived and applied for modelling solitary pulses.
- The energy localization is observed due to the interaction of the waves with periodically ordered elastic inclusions.
- A theoretical model of string-barrier interaction was developed and experimentally verified.
- A constitutive function for the heat flux in short fibre reinforced composites is derived.
- The scale-free network model of Estonian economy has been created. This allows us to pinpoint the key units of the economy, protection of which can improve the economical stability of the country.
- Scheme is developed which makes it possible to match real flows to ideal flows (which are delta-correlated in time). In particular, the concept of mixing dimension of flows which can take fractional values, is introduced.

Wave Engineering

- Spectrogram representation of one-point measurements is applied to identify and quantify the main properties of ship wake components.
- Ship-driven depressions of substantial height (> 0.3 m) often propagate for more than 1 km into the Venice Lagoon as strongly nonlinear Riemann waves.
- An abrupt turn of the geostrophic air-flow over the southern Baltic Sea by $\sim 40^\circ$ around 1987 has been proposed as an alternative explanation for a radical decrease in the frequency of major inflows of saltier water into the Baltic Sea since the mid-1980s.
- The risk of current-driven pollution to marine protected areas in the Gulf of Finland and to the coasts of this bay evaluated using 23 surface drifters deployed in 2011–2014.
- The water level variations at the eastern Baltic Sea coasts are separated into a Gaussian process (that reflects the water volume of the entire sea) and a Poisson-like process that reflects the impact of storm surges.
- Terrestrial and airborne laser scanning techniques are combined with the concept of equilibrium beach profile to quantify the changes in the total volume of sandy beaches.

Systems Biology

- We have shown existence of profound diffusion restrictions in the heart muscle cells. These restrictions are expected to play a major role in energy transfer, signaling, distribution of apoptotic factors and reactive oxygen species.
- We developed thermodynamically consistent approach to incorporate cooperativity between cross-bridges into Huxley-type models.
- An integrated approach to study calcium fluxes in the cells is developed. By mixing electrophysiological and fluorescence measurements, analysis with mathematical model, we established contribution of calcium fluxes to overall calcium dynamics in trout cardiomyocytes.
- Adenine nucleotide translocase (ANT) interaction with lipids and each other was studied using molecular dynamics simulations. We showed that formation and splitting of ANT clusters are frequent events.

Optics

- Temporal characterization scheme for ultrashort and ultrabroadband (from UV to IR spectral range) pulses was developed. This utilizes a third-order nonlinear process called transient grating and the design embeds several novel solutions enhancing the understanding of nonlinear transient gratings and cross-correlation frequency resolved optical gating technique. The research was carried out in the frames of post-doctoral research in Max Planck Institute for the Science of Light, supported by CENS.

Nonlinear Control Theory

- It was shown that any autonomous system can be made accessible and observable through a single actuator and sensor, whenever the vector field describing the system is not identically zero, as an easy consequence of the so-called straightening theorem.
 - Two notions – weak and strong integrability of differential one forms – were defined for nonlinear time-delay systems. Necessary and sufficient conditions were established for both types of integrability.
-
-

3. Current results 2015

3.1 Laboratory of Nonlinear Dynamics (IoC)

3.1.1 Dynamics of materials

Complexity in engineering and natural sciences.

An overview is presented on interdisciplinary studies into complexity of wave processes with the main attention to wave-wave, field-field, wave-internal structure a.o. interactions. The nonlinearity of these processes creates specific physical phenomena as a result of interactions. The basic assumptions of modelling, main hypotheses adopted and resulting governing equations are presented. Due to complexity of processes, numerical methods are mainly used for the analysis. However, in many cases the methods (the finite volume method, the pseudospectral method) must be modified in order to guarantee the accuracy and stability of solutions. The spectrum of problems modelled and analysed is wide including dynamical processes in solids, fluids and tissues (J.Engelbrecht).

Reflections on mathematical models of deformation waves in elastic microstructured solids.

The mathematical models derived for wave propagation in solids with internal structure are described. The focus is on one-dimensional models which enlarge the classical wave equation by higher-order terms. The crucial parameter in models is the ratio of characteristic lengths of the excitation and the internal structure. Novel approaches based on the concept of internal variables permit one to take the thermodynamical conditions into account directly. Examples of generalisations include frequency-dependent multiscale models, nonlinear models and thermoelasticity. The substructural complexity within the framework of elasticity gives rise to dispersion of waves. Dispersion analysis shows that acoustic and optical branches of dispersion curves together describe properly wave phenomena in microstructured solids. In the case of nonlinear models, the governing equations are of the Boussinesq type. It is argued that such models of waves in solids with microstructure display properties that can be analysed as phenomena of complexity (J.Engelbrecht, A.Berezovski).

On mathematical modelling of solitary pulses in cylindrical biomembranes.

The propagation of action potentials in nerve fibres is usually described by models based on the ionic hypotheses. However, this hypothesis does not provide explanation of other experimentally verified phenomena like the swelling of fibres and heat production during the nerve pulse propagation. Heimburg and Jackson (2005, 2007) have proposed a model describing the swelling of fibres like a mechanical wave related to changes of longitudinal compressibility of the cylindrical membrane. The possible dispersive effects in such microstructured cylinders are analysed from the viewpoint of solid mechanics, particularly using the information from the analysis of the well-known rod models. A more general governing equation is proposed which satisfies the conditions imposed by the physics of wave processes. The numerical simulations demonstrate the influence of nonlinearities, the role of various dispersion terms and the formation and propagation of solitary waves along the wall together with the corresponding transverse displacement (Fig. 1). It is conjectured that due to the coupling effects between longitudinal and transverse displacements of a cylinder, the transverse displacement (i.e., swelling) is related to the derivative of the longitudinal displacement. In this way the correspondence between theoretical and experimental (Tasaki, 1988) results can be described (J.Engelbrecht, K.Tamm, J.Peets).

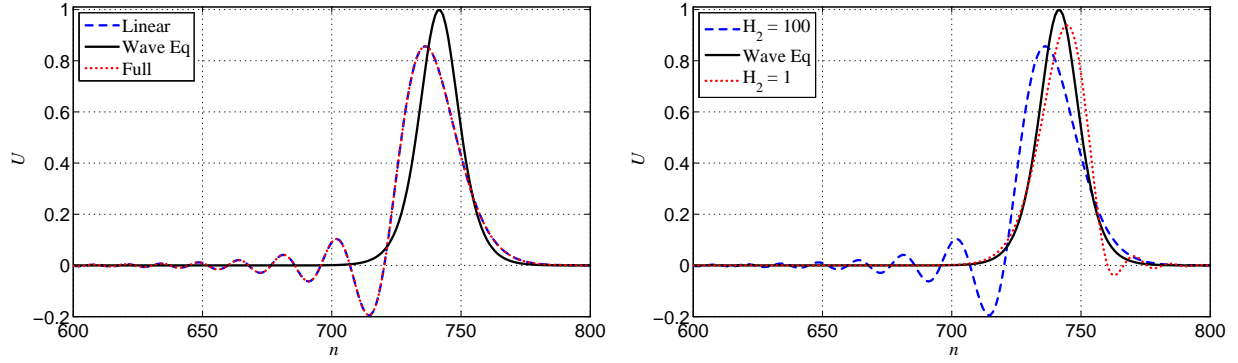

Figure 1: Typical wave profiles.

Pattern formation of elastic waves and energy localization due to elastic gratings.

Elastic wave propagation through diffraction gratings is studied numerically in the plane strain setting. The interaction of the waves with periodically ordered elastic inclusions leads to a self-imaging Talbot effect for the wavelength equal or close to the grating size. The energy localization is observed at the vicinity of inclusions in the case of elastic gratings (Fig. 2). Such a localization is absent in the case of rigid gratings. The single slit diffraction in optical, acoustic, and elastic cases is analysed. It is shown that wave fields downstream the slit are similar in optical and acoustic cases. The case of elastic is different due to the coupling of longitudinal and transverse waves (A.Berezovski, J.Engelbrecht).

Legacy of Nikolai Alumäe: theory of shells.

A short overview on the research of Nikolai Alumäe (1915–1992) in the field of the theory of shells is presented. His brilliant analytical results explaining the stability and transient processes in shells have not lost their importance although obtained in the 1950s and 1960s (J.Engelbrecht, M.Kutser).

Dispersive effects in wave motion.

Dispersion is a characteristic feature for wave propagation in microstructured solids. In the case of linear elasticity, dispersion effects are modelled by higher-order derivatives included into the wave equation. Nonlinear effects are also well known in wave propagation in solids. In principle,

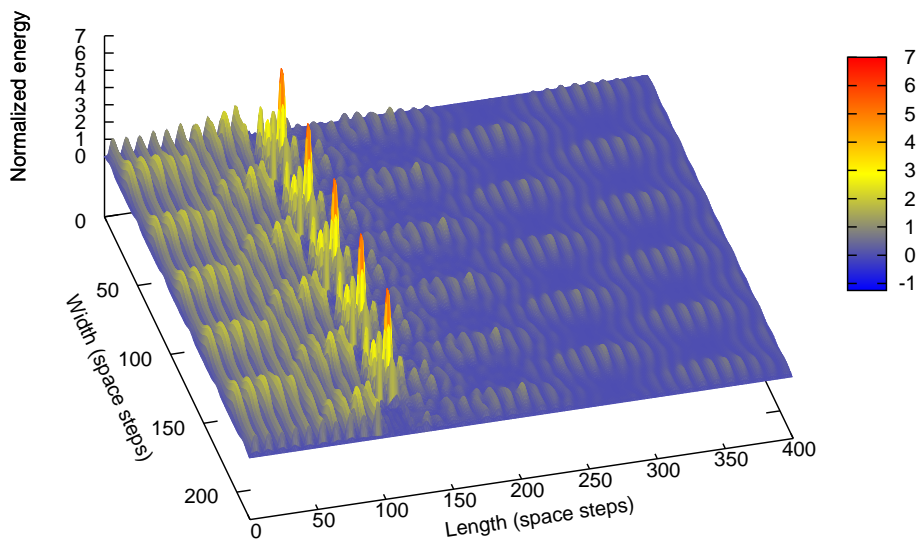

Figure 2: Energy localization in the vicinity of an elastic grating.

such effects may appear at the macroscale as well as at the microscale. The microstructural influence is often taken into account by the introduction of internal variables. This suggests that internal variables may behave nonlinearly. It is shown that the nonlinear behaviour of internal variables may lead at the macroscale to the Benjamin–Bona–Mahoney equation or the Camassa–Holm equation (A.Berezovski).

Waves in microstructured solids, numerics.

Reflection and transmission of elastic waves at the interface between two distinct micromorphic media are considered in the one-dimensional setting. A dual internal variable approach is used for the description of the microstructure influence on the global motion. It is shown that reflection and transition coefficients for plane waves depend on the coupling between macro- and micro-motions as well as on the choice of the microstructural interaction at the interface. Numerical simulations exhibiting results with promising technological implications are shown (A.Berezovski, I.Giorgio, A. Della Corte).

Several approaches for numerical modelling of one-dimensional discontinuous elastic wave propagation in solids are compared. Propagation of stress discontinuity in a shock loaded bar is used as a benchmark test. The classical finite element method with different time schemes, the Park’s explicit time integrator based on pullback interpolation, the central difference method in space and time, the finite volume method with different limiters, isogeometric analysis with different time schemes, the discontinuous Galerkin method and the variational time integrator are tested.

The special attention is paid to comparison of front- and post-shock spurious oscillations occurring in the stress distribution along the bar (R.Kolman, A.Berezovski, S.S.Cho, J.Kopačka, D.Gabriel, K.Tamm, J.Plešek, K.-C.Park).

Acoustodiagnosics of inhomogeneous solids.

Analytical and numerical methods have been compared to describe the initial stage of nonlinear propagation and reflection of longitudinal ultrasonic waves. The perturbation method has been used to derive the analytical solution and the finite difference scheme to find the numerical solution for multiple free-boundary reflections of a harmonic burst at ultrasonic frequencies. At higher frequencies and larger nonlinear effects some quantitative differences between analytical and numerical results appear. The results are applicable for NDT and nonlinear vibrations (A.Braunbrück).

Nonlinear phenomena of the sound generation in piano.

A novel high accuracy experimental equipment for acoustical measurements of vibrating objects has been designed and built. This set-up consists of a high framerate line scan camera and a custom-built optical lens system. In preparation for experimental measurements on piano and various lutes the theoretical model of string–barrier (agraffe) interaction was developed and studied. The results obtained from the study expand our knowledge and understanding of the timbre evolution and the physical principles of sound generation of numerous stringed instruments, such as lutes called the tambura, sitar and biwa.

On the basis of the experimental data of a piano hammers study a one-dimensional constitutive equation of the wool felt material was studied.

Using the results of the study of acoustical wave propagation in the hereditary microstructured wool felt, it was demonstrated that due to the nonlinear piano hammer stiffness, the duration of the hammer–string contact decreases as the dynamic rate of the hammer impact is raised. Subsequently, for the first piano bass hammers the contact duration is shorter than the round-trip time to agraffe and back. This phenomenon can explain the fact that the bass hammer is released from the piano string without the assistance of travelling wave reflected from the piano agraffe.

In frame of the self-consistent mathematical model, which includes the dynamics of a material and the state of its defects, the particular qualities of acoustic wave propagation in the material

with damages are considered. In this study a novel constitutive equation of a damaged medium was derived, and the similarity between the models for damaged materials and the medium with memory was confirmed. The dispersion analysis of the model was carried out, and it was shown that the damage of the material gives rise to frequency-dependent attenuation and anomalous dispersion of the phase velocity of acoustic wave propagating through that material. This makes it possible to estimate the damage of the material by means of a non-destructive acoustic method (A.Stulov, D.Kartofelev).

An orthotropic material model for steel fibre reinforced concrete based on the orientation distribution of fibres.

Constitutive mappings for steel fibre reinforced concrete, SFRC are analyzed. The anisotropic properties of this composite are caused by the orientation distribution of fibres. The constitutive relation is developed for one meso-volume element of SFRC as a combination of isotropic and orthotropic St. Venant-Kirchhoff material models, which are applied to concrete matrix and to steel fibres, respectively. The alignment tensors and orientation distribution function adopted from the mesoscopic continuum theory are utilised to identify the material meso-symmetry axes and to assess the contribution of fibres in the symmetry axes defined. While assessing the orthotropic meso-elasticity for fibres, the elasticity of an individual fibre in its local coordinates is transformed into the material meso-symmetry axes and weighted with the orientation distribution function of fibres. The advantage of the material model developed for SFRC is that it uses complete orientation information of fibres (two angles in spherical coordinates) and utilises tensor quantities complying with material objectivity (M.Eik, J.Puttonen (Aalto), H.Herrmann).

Orthotropic constitutive model for steel fibre reinforced concrete: linear-elastic state and bases for the failure.

Steel fibre reinforced concrete (SFRC) is a highly promising building material offering durable structures alongside with the minimisation of steel consumption and construction time. Though, its reliable application in civil engineering requires a deeper study due to complex material properties defining its failure and related to volumetric dispersion of fibres, and a bond between the fibres and concrete. The different fibre alignments in concrete matrix lead to anisotropic behaviour, which specifies the tensile strength and the crack intensity of the composite. SFRC crack initiation and development, and failure depend on the strength of the bond and interaction between the steel fibres and concrete. The modelling of SFRC linear-elastic state considering and evaluating the orientation distribution of fibres is presented. In addition, the bases of SFRC failure are introduced (M.Eik, H.Herrmann, J.Puttonen).

Analysis of ship wake transformation in the coastal zone by use of time-frequency methods.

Ship wake transformation in the coastal zone is analysed based on field measurements of wave conditions at two measurement sites located about 20 m and 100 m from the shore. Analysis of single wake events recorded at both sites is carried out by transforming the time series of the wave amplitude into the time-frequency domain, using both a short-time Fourier transform and a wavelet transform. Analysis reveals that signature features of individual wake components can be tracked as the wake approaches the shore, but the wave amplitude and associated wave energy is transformed differently for different wake components. The wake energy is reduced as the waves propagate through the surf zone, which can be attributed mainly to wave breaking of the leading wave system and a significant reduction of the divergent wave system. However, the energy of transverse waves is stable or increasing, indicating that these waves undergo a non-breaking shoaling process (T.Torsvik, H.Herrmann, I.Didenkulova, A.Rodin).

Scalable medical viewer for virtual reality environments.

A scalable virtual reality-based software for medical visualization is derived. Usable on a desktop, on a head-mounted display or on a CAVE-like system, the application allows the full inspection of

CT or MRI images superimposed to the 3D models of the organs built from these images (Fig. 3). Additionally full volume rendering functionalities and several interaction tools as transparencies, choice of the CT slice to display, hiding and showing of meshes and additional information on the scanning procedure are available. The tool aims at offering an in-depth inspection of the body organs for medical, education and surgical preoperative planning. (F.Ricciardi, E.Pastorelli, L.Tommaso De Paolis, and H.Herrmann).

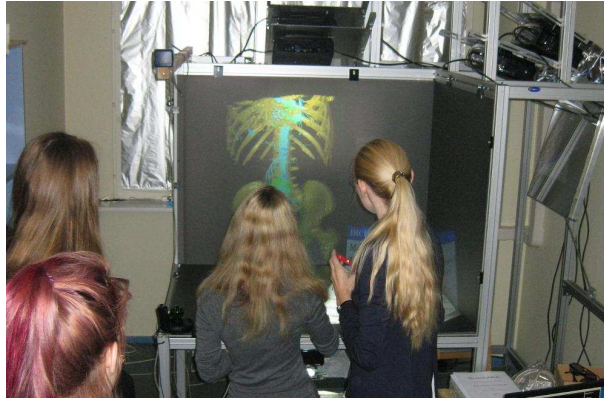

Figure 3: Some students trying out the scalable medical viewer MedImVr, during a visit to the lab.

Photogrammetry based methodology for construction of a first reference 3D model of Pakri cliff for future monitoring of coastal changes and hazard assessment for Pakri lighthouse.

The use of photo-based surface reconstruction technique is derived to reveal its potential to monitor and survey vulnerable parts of the Estonian coast. The aim of the study is to outline the general approach to data acquisition and processing using images acquired from unmanned aerial Vehicles (UAVs) in producing a 3D model for Pakri cliff, north-western Estonia (Fig. 4). It is shown that an adequate 3D model of the area can be acquired at high resolution and in much shorter time interval than would normally be achieved through alternative methods. We provide some examples for the use of such technique while pointing to free software packages for data processing, visualization and 3D interpretation. Photogrammetric models serve to act as a cheap alternative to laser scanning or aircraft-based photographic surveys and can be used as a rough estimation of the evolution of the coast due to the action of the sea and other natural and human-induced hazards (H.Herrmann, K.Kasepõld, I.Zaitseva-Pärnaste, E.Pastorelli, and I.Didenkulova).

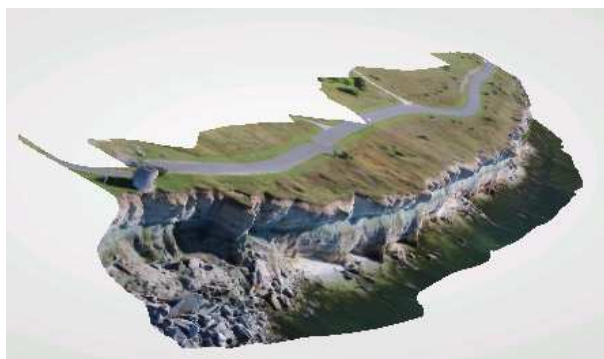

Figure 4: 3D model of Paldiski cliff constructed from photos taken by a drone.

A constitutive function for the heat flux in short fibre reinforced composites.

A constitutive function for the heat flux in short fiber reinforced composites is derived. The fiber orientation distribution is considered by means of the second order orientation tensor, therefore the constitutive function for the heat flux will depend on the orientation tensor. The resulting orthotropic equation is discussed also in the context of energy efficiency of buildings (H.Herrmann).

Time-efficient automated analysis for fibre orientations in steel fibre reinforced concrete.

One of the most important factors to determine the mechanical properties of a fibre composite material is the orientation of the fibres in the matrix. Their orientation might differ in distinct parts of the structural element as dependent from the casting techniques and mould materials. An algorithm to retrieve the single fibre's orientation information out of SFRC samples scanned through a μ CT scanner is presented (Fig. 5). The software implemented with the algorithm includes a data filtering component to remove the noise from the datasets and prepare them correctly for the analysis. Due to its short computational times and its almost complete lack of need for external user intervention, the software is able to process and analyse large batches of data in short periods by providing results in a variety of visual and numerical formats (E.Pastorelli, H.Herrmann).

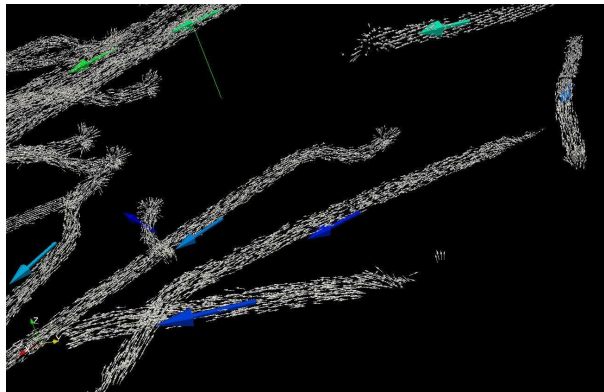

Figure 5: Fibre orientation analysis in steel fibre reinforced concrete.

Software Development:

A.C.T.I.V.E.: – A scalable tool for Virtual Reality visualization of superellipsoid-based glyphs depicting the orientation equation of SFRC fibres during a CFD casting simulation. The software uses VRUI as framework and is therefore equally suitable for desktop or VR systems (M.Padilla (TU Berlin), M.Krause (RWTH Aachen), E.Pastorelli, H.Herrmann).

<http://bitbucket.org/VisParGroup/active> uTANS: Fibre orientation analysis from CT volumes, consisting of two subprograms for filtering and analysis (E.Pastorelli, H.Herrmann).

<https://bitbucket.org/VisParGroup/utans-fib>

<https://bitbucket.org/VisParGroup/utans-filt> MedImVR: Scalable Virtual Reality Viewer for medical images (CT, MRT, etc) (F.Ricciardi (Univ. Salento), E.Pastorelli, H.Herrmann).

<https://bitbucket.org/VisParGroup/medimvr> alignment: A package for GNU R to calculate alignment tensors and the orientation distribution function (H.Herrmann, M.Eik).

<https://bitbucket.org/vispar/alignment>

3.1.2 Fractality and econophysics.

Econophysics.

Based on the wire transfer database of Swedbank, a model of economical network of Estonia has been created. This is world-wide a unique database as it covers dominating majority (ca 80%) of the economy of a single country. We have studied the scaling-free and structural properties of this network, and described its topology, components and behaviors. We have shown that this network shares typical structural characteristics known in other complex networks: degree distributions follow a power law, low clustering coefficient and low average shortest path length. We have performed simulations of resiliency of the network against random and targeted attacks of the nodes with two different strategies. Thereby we have found the most vulnerable nodes of the Estonian economy with respect to economic shocks. This finding can be used to develop strategies for increasing economical stability of Estonia (S.Rendon, R.Kitt, J.Kalda).

Turbulent mixing.

Majority of theoretical results regarding turbulent mixing are based on the model of ideal flows with zero correlation time. We have analyzed the reasons why such results may fail for real flows and developed a scheme which makes it possible to match real flows to ideal flows. In particular we introduce the concept of mixing dimension of flows which can take fractional values. For real incompressible flows, the mixing dimension exceeds the topological dimension; this leads to a local inhomogeneity of mixing — a phenomenon which is not observed for ideal flows and has profound implications, for instance impacting the rate of bimolecular reactions in turbulent flows. We have shown that finite time-correlations lead to non-universality of mixing as the mixing dimension depends on the statistical properties of the underlying flow, see Fig. 6.

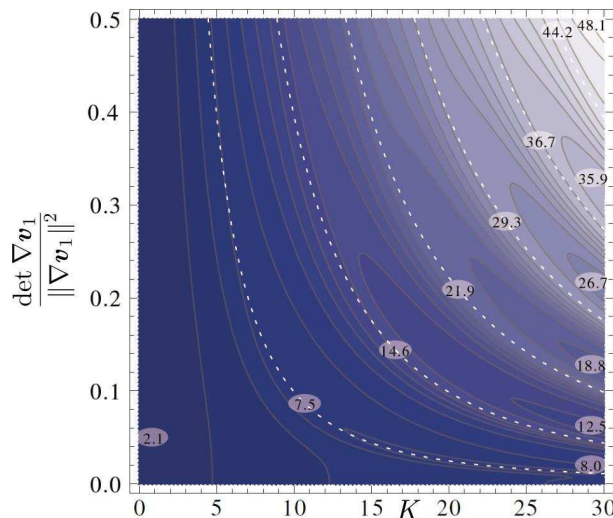

Figure 6: Mixing dimension d_m of a 2D incompressible flow as a function of the determinant of the velocity gradient and the Kubo number $K \equiv \tau \|\nabla \mathbf{v}_1\|$.

We have addressed the problem of anomalously fast rain initiation in warm clouds by proposing a novel approach based on the idea that turbulent mixing brings together droplets of very different histories and hence, of very different sizes, similarly to how passive scalar fronts are formed. We made relevant analytical estimates, and simulations based on 1-dimensional model of turbulence (stochastic triplet map similar to the Baker’s map). This mapping model captures the essential stretching and folding nature of turbulent flows. The triplet mapping is accompanied by averaging of neighboring distributions, corresponding to local diffusive mixing of droplets. In particular, we have studied the widths (variances) of local drop size distributions, which appear to follow a power law. Accordingly, we witness occasional instances of extremely broad drop

size distributions, which can trigger the rain formation (J.Kalda et al.).

3.1.3 Laboratory of Photoelasticity

Stress measurement in tempered glass panels.

A new method, method of relaxation, has been developed for the measurement of stress in chemically tempered glass panels. Since the gradient of residual stresses in case of chemical tempering is extremely high, surface stress measurement with the scattered light method as well as with using the tunneling effect is highly difficult. With the relaxation method, a cut is made in the panel through the thickness along a certain line. At the cut surface, stresses normal to the cut surface vanish. That can be interpreted as applying to the surface of the cut residual stresses, but of opposite sign. Near the cut a singular stress distribution is created. This stress field has components both perpendicular to the surface of the panel as well as in the surface of the panel. These stresses are not in equilibrium through the panel thickness. By observations in a polariscope perpendicular to the panel surface, birefringence, caused by this singular stress field can be measured. This stress field depends on the residual stress distribution through the panel thickness. The latter can be determined by solving the inverse problem. This work is a cooperation with the Institute of Physics of the Tartu University (H.Aben, et al.).

3.2 Laboratory of Wave Engineering (IoC)

Wave dynamics.

Ships of moderate size, sailing at low depth Froude numbers (0.37–0.5) in a navigation channel surrounded by shallow banks in Venice Lagoon, produce depressions with depths up to 2.5 m. These depressions (Bernoulli wakes) propagate as long-living strongly nonlinear solitary waves of depression substantial distances. These waves are interpreted as long-living strongly nonlinear Riemann (simple) waves of depression. Their properties are replicated using nonlinear shallow water theory and the CLAWPACK software. It is demonstrated that such depressions of substantial height (> 0.3 m) often propagate for more than 1 km into areas of the lagoon of approximately 2 m water depth. The depression waves gradually become strongly asymmetric with the rear of the becoming extremely steep, similar to a bore, and its amplitude becomes almost independent of the initial properties of the disturbance (T.Soomere and A.Rodin in cooperation with scientists from Venice and Townsville).

The spectrogram representation of one-point measurements of the ship wake is applied to identify and quantify the main properties of the wake components. The wake is reliably decomposed into constituents, the variations of which are quantified in the time–space domain. The majority (60–80%) of wake energy from strongly powered large ferries that sail at depth Froude numbers ~ 0.7 is concentrated in components that are located near the edge of the wake wedge. The spectrogram representation offers a convenient way to identify a specific signature of single types of ships. A method for estimation of the ship speed and the distance of its sailing line from the measurement site is proposed, which only uses information available within the record of the ship wake surface elevation (T.Torsvik, T.Soomere, I.Didenkulova in cooperation with A.Sheremet).

Ship wake transformation in the coastal zone is analysed based on measurements of wave conditions about 20 m and 100 m from the shore of Tallinn Bay, the Baltic Sea. The time series of the wave amplitude is transformed into the time–frequency domain. Signature features of individual wake components persist as the wake approaches the shore. The wake energy is reduced as the waves propagate through the surf zone apparently owing to breaking of the leading waves and a reduction of the divergent wave system. The energy of transverse waves is stable or increasing. Thus, these waves undergo a non-breaking shoaling process (T.Torsvik, H.Herrmann, I.Didenkulova, A.Rodin).

Run-up of solitary waves of different bell-like shapes (solitary-like and Lorentz-like waves and

sine-like pulses) is studied in a linearly inclined bay of parabolic cross-section. It is shown that maximum run-up heights, maximum water flow velocities, and parameters of wave breaking on the beach for different pulses of the same height and characteristic wavelength coincide with an acceptable accuracy, hence allowing parameterization of the corresponding formulas for run-up characteristics. The uncertainty of the incoming tsunami wave shape in terms of the forecast of its run-up characteristics in bays of different type is discussed using two typical beach geometries: plane beach and U-shaped bay are considered (I.Didenkulova in cooperation with O.Didenkulov and E.Pelinovsky).

A pair of alternatives of KdV-type equations (correct up to the second order in small parameters of nonlinearity and dispersion) are derived for the displacements of both modes of long weakly nonlinear finite-amplitude internal waves and for each interface in a three-layer fluid. These equations are integrable for a very limited set of coefficients and do not allow for proper description of several near-critical cases. A more specific equation allowing for a variety of solitonic solutions and capable of resolving most near-critical situations is derived by means of the introduction of another small parameter. This procedure leads to a pair of implicitly interrelated alternatives of Gardner equations for the two interfaces. A detailed analysis is presented of various regimes of the appearance and propagation of their soliton solutions. It is shown that both the quadratic and the cubic nonlinear terms vanish for several realistic configurations of such a fluid (cooperation of T.Soomere with O.Kurkina, A.Kurkin and E.Rouvinskaya).

The propagation and transformation of long internal breather-like wave is analysed in the conditions matching the average summer stratification in the southern Baltic Sea. The focus is on changes in the properties of the breather when the water depth increases and the coefficient at the cubic nonlinear term changes its sign, equivalently, the breather cannot exist anymore. The simulations are performed in parallel in the framework of weakly nonlinear Gardner equation and using fully nonlinear Euler equations. The amplitudes of breathers in these frameworks have slightly different courses in idealised conditions (when Earth's rotation is neglected). The impact of the background rotation substantially depends on the spectral width of the initial breather. The evolution of narrow-banded breathers is almost the same for rotating and non-rotating situations. Amplitudes of breathers with a wide spectrum experience substantial changes in realistic situation with the background rotation. A narrow-banded breather that propagates along a path in the Baltic Sea over a location where the cubic nonlinear term changes its sign disintegrates into a precursor soliton and a transient dispersive wave group (cooperation of T.Soomere with O.Kurkina, E.Rouvinskaya, T.Talipova and D.Tyugin).

Lagrangian transport.

Statistical properties of the drift of floating items from the major fairway to the coast and numerically simulated transport of pollution by surface currents to the nearshore are compared based on tracks of 23 surface drifters that crossed the fairway in the central part of the Gulf of Finland in 2011–2014 and 17 280 simulated trajectories of passive virtual parcels using velocity fields from the Rossby Centre Ocean (RCO) model in 2000–2004. More than 25% of the drifters that crossed the major fairway in the area north and north-west of Tallinn reached either the southern (Estonian) or northern (Finnish) coast. This probability matches similar estimates for single water parcels that are locked in the surface layer and exclusively carried by simulated currents. The probability of reaching the Estonian and Finnish nearshore by simulated parcels or the coast by drifters is roughly equal. Both surface drifters and virtual parcels generally drifted to the west before they reached the coast or nearshore, except for surface drifters that arrived on the Estonian coast.

The same set of drifters is used to evaluate the risk of current-driven pollution to marine protected areas (MPAs) in the Gulf of Finland. About 2/3 of the drifters entered into one of the MPAs. The majority of drifters reached the Ekenäs Archipelago near the western coast of Finland. The travel time from the fairway to the MPAs ranged from 1.3 days to 36.1 days. Therefore, different processes may influence the surface circulation patterns and the drifters can

travel long distances before reaching a MPA.

An overview is presented of a preventive method for minimizing environmental risks based on the optimization of the location of potentially dangerous activities and developed in the laboratory since 2009. The precondition is the frequent presence of semi-persistent surface current patterns that render the probability of transport of dangerous substances (for example, oil pollution) from different open sea areas to vulnerable regions highly variable. Principles, key components and applications of a prototype method for the identification of such areas and for their use in environmental management of shipping, offshore and coastal engineering activities are described. The core idea is to identify and quantify the potential of different offshore domains to serve as a source of danger to the vulnerable areas through pollution transport by various met-ocean drivers. An approximate solution to this inverse problem of pollution propagation is obtained by means of statistical analysis of a large number of solutions to the direct problem of propagation of tracers in terms of Lagrangian trajectories. The offshore domains are quantified in terms of the probability of the current-driven adverse impact reaching the near-shore after an accident has happened or, alternatively, in terms of time until this impact (for example, an oil spill) reaches the coast (B.Viikmäe, N.Delpeche-Ellmann, T.Torsvik, T.Soomere).

Wave and wind climatology.

Records of visual wave observations from 1946 to 2012 at 8 observation sites at the eastern coast of the Baltic Sea show that the wave height substantially decreased until about 1970, and considerable decadal variations have occurred since then. The coherence between annual average wave heights at different locations was lost at the end of the 1980s. The simulated net potential wave-driven sediment transport along the eastern coast of the sea for 1970 to 2007 based on geostrophic winds reveals a major change at the end of the 1980s. This change is associated with an abrupt turn of the geostrophic air-flow over the southern Baltic Sea by $\sim 40^\circ$ around 1987. This change may serve as an alternative explanation for a radical decrease in the frequency of major inflows of saltier water into the Baltic Sea since the mid-1980s (T.Soomere, A.Räämet, M.Viška in cooperation with S.R.Bishop).

The contribution of wave set-up into the formation of extreme water levels at the waterfront in the Tallinn area of the north-eastern Baltic Sea is evaluated using the wave properties computed for 1981–2014 with a triple-nested WAM model with a horizontal resolution of about 470 m. The offshore water level is extracted from the output of the Rossby Centre Ocean (RCO) model. The maximum setup may reach 0.7–0.8 m in some coastal sections and the all-time highest measured water level is 1.52–1.55 m in the study area. The high offshore water levels are only infrequently synchronized with extreme set-up events. Wave set-up may contribute to the all-time maximum water level at the shoreline by up to 0.5 m. This contribution considerably varies for different years. The largest contribution from set-up into extreme water levels usually occurs during north-westerly storms (K.Pindsoo and T.Soomere).

A comprehensive overview has been presented about variations in the wave climate of the Baltic Sea since the beginning of systematic visual wave observations in the 1940. The existing data sets of wave observations, measurements and numerical replications are compared and the main patterns of changes identified. While average wave properties over the entire sea exhibit very limited changes, substantial variations have been identified on a decadal scale and in single domains (T.Soomere, in cooperation with the BACC author team).

Coastal processes and other applications.

The water level variations at the eastern Baltic Sea coasts are separated into components reflecting the impact of storm surges and changes in the water volume of the entire sea. The distribution for the weekly-scale water level represents the entire water volume and has an almost Gaussian shape. For the 8-day average the distribution of the residual, interpreted as the frequency of occurrence of local storm surges, almost exactly matches the exponential distribution that can be considered as reflecting the time between events of the underlying Poisson process. All extreme values (outliers) of water level that do not match the classical statistics are a part of the exponential distribution of storm surges. Such separation of phenomena on different temporal scales is universal for the entire eastern Baltic Sea coast. The slopes of the exponential distribution for low and high water levels are different and provide a useful quantification of different coastal sections with respect to the probability of coastal flooding (M.Eelsalu and T.Soomere in cooperation with A.Kurkin and A.Rybin).

Terrestrial (TLS) and airborne laser scanning (ALS) techniques are combined with the classical concept of equilibrium beach profile to quantify the changes in the total sand volume of slowly evolving sandy beaches. The changes in the subaerial beach are determined from a succession of ALS surveys that were reduced to the same absolute height using a TLS survey of a large horizontal surface of constant elevation. The changes in the underwater sand volume from the waterline down to the closure depth are evaluated using an inverse of the Bruun Rule. The relocation of the waterline is extracted from the ALS scanning of elevation isolines of 0.4–0.7 m. The method is applied to the central part of Pirita Beach (Tallinn Bay, north-eastern Baltic Sea). The sand volume in this area exhibits extensive interannual variations. The annual gain of sand in the entire beach was about $2000 \text{ m}^3/\text{y}$ in 2008.–2010 and the annual loss was about $1100 \text{ m}^3/\text{y}$ in 2010–2014. The changes in the underwater part of the beach are by a factor of 2–2.5 larger than the changes in the subaerial part (M.Eelsalu and T.Soomere in cooperation with K.Julge).

An updated set of indicators of coastal vulnerability has been developed and implemented for the Lithuanian Baltic Sea coast to characterise relatively low-lying coastal segments with negligible tidal range but affected by substantial storm surges driven by atmospheric factors. The classical methods for building the coastal vulnerability index (CVI) are combined with the outcome analytical hierarchical process (AHP) based approach for incorporating experts' judgements to specify the weights of used criteria. The CVI relies mostly on geological parameters (shoreline change rate, beach width/height, underwater slope, sand bars, and beach sediments) and involves only significant wave height as the representative of direct physical drivers. It is shown that about 10% of the coast in the study area is under very high risk (cooperation of T.Soomere with I.Bagdanavičiūtė and L.Kelpšaitė).

A new tool for extracting information from the Finnish Meteorological Institute's Open Data dataset in an easy way is introduced. The tool allows retrieving meteorological time series of time-value pairs of weather, marine and climate observations (A.Giudici).

3.3 Laboratory of Systems Biology (IoC)

Intracellular diffusion restriction in cardiomyocytes.

In cardiomyocytes, there are two types of diffusion obstacle that have shown to interfere with energy transfer from mitochondria to ATPases: mitochondrial outer membrane (MOM) and cytoplasmic diffusion barriers grouping ATP-producers and -consumers. While the mechanism responsible for restricting diffusion through MOM involves interaction between voltage-dependent anion channel (VDAC) and tubulin leading to the closure of VDAC for ATP and ADP, the number of open and closed VDACS *in vivo* remains unknown. In addition, there is no method developed so far that can clearly distinguish the contributions of cytoplasmic barriers and MOM to the overall diffusion restriction in cardiomyocytes. The aim of this work was to es-

establish the partitioning of intracellular diffusion obstacles in cardiomyocyte. For that, we studied the response of mitochondrial oxidative phosphorylation of permeabilized rat cardiomyocytes to changes in extracellular ADP by recording 3D image stacks of NADH autofluorescence. Using reaction-diffusion theory, cell-specific finite element models, and comparing the model solution to the measured data, we were able to determine the permeability of MOM and cytoplasmic barriers. Our results demonstrate that MOM and cytoplasmic barriers have similar contribution to overall diffusion restriction. In our conditions, most of VDAC are in closed conformation with only $\sim 2\%$ VDACs open for ADP access and cytoplasmic diffusion barriers reducing the apparent diffusion coefficient by 6-10 \times . Such profound diffusion restrictions are expected to play a major role in energy transfer, signaling, distribution of apoptotic factors and reactive oxygen species (P.Simson, N.Jepihhina, M.Laasmaa, P.Peterson, R.Birkedal, M.Vendelin).

Cross-Bridge Group Ensembles Describing Cooperativity in Thermodynamically Consistent Way. The aim of this work is to incorporate cooperativity into Huxley-type cross-bridge model in thermodynamically consistent way. While the Huxley-type models assume that cross-bridges act independently from each other, we take into account that each cross-bridge is influenced by its neighbors and cooperativity is induced by tropomyosin movement. For that, we introduce ensembles of cross-bridge groups connected by elastic tropomyosin (Fig. 7). By taking into account that the mechanical displacement of tropomyosin induces free energy change of the cross-bridge group ensemble, we develop the formalism for thermodynamically consistent description of the cooperativity in muscle contraction. An example model was composed to test the approach. The model parameters were found by optimization from the linear relation between oxygen consumption and stress-strain area as well as experimentally measured stress dynamics of rat trabecula. We have found a good agreement between the optimized model solution and experimental data. Simulations also showed that it is possible to study cooperativity with the approach developed in this work (M.Kalda, P.Peterson, M.Vendelin).

An integrated approach to study calcium fluxes in the cells.

In cardiac excitation-contraction (e-c) coupling, calcium enters the cytosol via L-type Ca^{2+} -channels and reverse $\text{Na}^+/\text{Ca}^{2+}$ -exchange (NCX_{rev}), or is released from the sarcoplasmic reticulum by Ca^{2+} -induced Ca^{2+} -release (CICR). The magnitude of calcium influx via the different pathways varies with the state of the cell. For example, in case of heart failure, CICR decreases and influx via NCX_{rev} increases. In this work, we propose a method to assess the Ca^{2+} -dynamics via different pathways during e-c coupling under physiological conditions. The method is based on mathematical analysis of measured transsarcolemmal Ca^{2+} currents during AP-clamp together with fluo-4 fluorescence. With this method, we were able to quantify the contribution and kinetics of L-type Ca^{2+} channel, NCX and SR in trout cardiomyocytes (M.Laasmaa, R.Birkedal, M.Vendelin).

ANT interactions with the local environment.

As a part of energy transfer from mitochondria to surrounding ATPases, adenine nucleotide translocase (ANT) plays a vital role by exchanging ATP and ADP through mitochondrial inner membrane (MIM). In the heart, ANT can form a coupled system with creatine kinase and facilitate synthesis of phosphocreatine by providing ATP. However, the exact mechanism of such coupling is not clear. As a part of studies of protein interaction within MIM, we studied dynamics of ANT in MIM and analyzed formation of ANT complexes. For that, we used a new coarse-grained molecular dynamics simulation model of MIM, recently introduced by us. The model consists of a membrane patch with several ANTs inserted. The model membrane consists of three major types of lipids: phosphatidylcholine, phosphatidylethanolamine, and cardiolipin in a roughly 2:1:1 molar ratio. All simulations were carried out with the GROMACS molecular dynamics package using the MARTINI coarse-grained force field with polarized water model. We demonstrate that proteins drift in MIM, grouped or not. Clustering and splitting of ANT complexes is possible and quite frequent, depending on the angle and distance between two

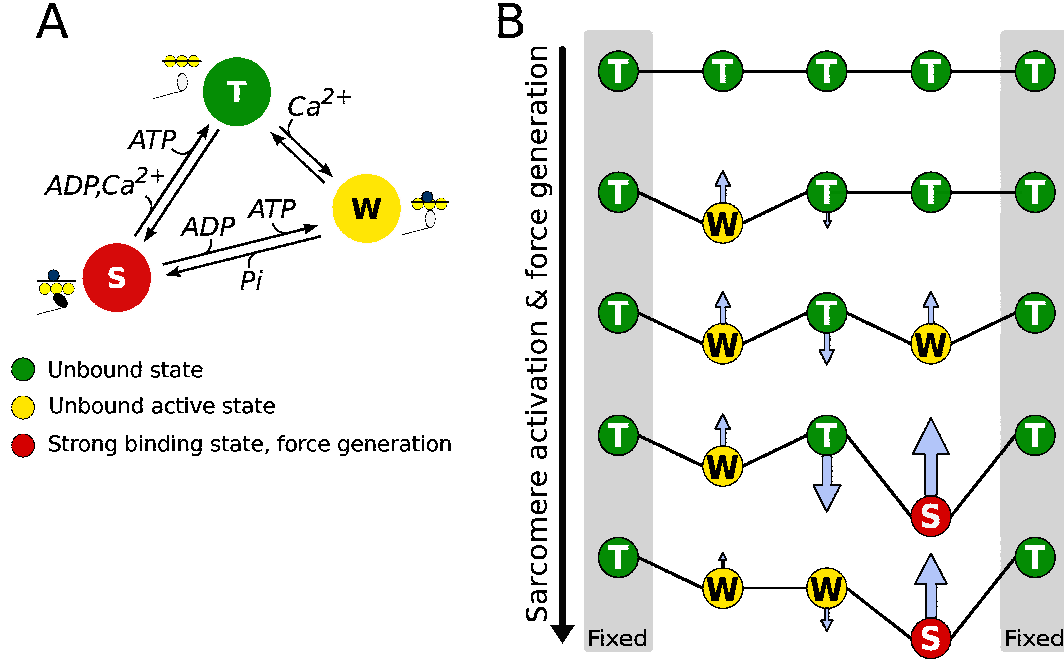

Figure 7: Computational model of the cross-bridge interaction. (A) Kinetic scheme of actin and myosin interaction used in three-state Huxley-type cross-bridge model. (B) Incorporating cooperativity into half-sarcomere activation and force generation. We consider an ensemble of five consecutive cross-bridges (binding states), out of which the first and the last ones are always in unbound state as boundary conditions. Arrows indicate the influences the neighboring binding states due to elastic deformation on tropomyosin, that connects all cross-bridges in a group, on binding of Ca^{2+} (transition from T to W) or force generation (transition from W to S)

proteins when approaching each other. Our simulations suggest that grouping of ANT is a property of the system and we expect to see such clusters *in vivo*. We show that cardiolipin is the most prominent type of lipid that participates in ANT interactions. In addition, the model is capable of mimicking biological events such as cardiolipin flip-flops from one side of the membrane to another (J.Karo, P.Peterson, M.Vendelin).

3.4 Optics group (UT)

Interplay between numerous nonlinear effects in hollow core, gas filled light guides and photonic crystal fibres enable generation of various coherent pulses, for example self-compressed pulses of few-cycle duration of inherently broad spectrum, and tuneable ultrashort pulses in UV. The few-cycle pulses are valuable tool in many other fields, for example in spectroscopic investigation of molecules, in high-field physics for high-harmonic and isolated attosecond pulse generation at extreme ultra violet (UV) and even shorter wavelengths, to mention few. In the given applications it is critical to know the exact temporal characteristics of the pulse – amplitude and the phase. A cross-correlation frequency resolved optical gating (XFROG) device in single shot arrangement was designed and realized for that purpose. The XFROG is designed to work in ultrabroad spectral range extending from 200 up to 1100 nm, utilizes the transient grating induced by the intense reference pulses acting as both optical gate and diffractive element and is capable of characterizing few cycle pulses in the given spectral range. The measurements were carried out in both UV and visible spectral range. The manuscript is prepared and will be submitted during first months of next year.

In many applications the single mode operation of an optical fiber is essential (see Fig. 8). Sampling the signal and reference pulses to the SEA TADPOLE-type spatial-spectral interfer-

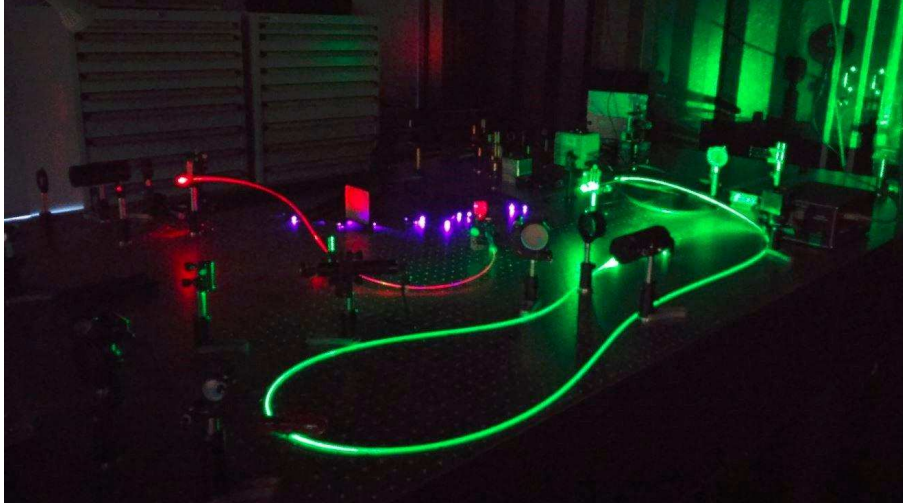

Figure 8: Fibres on the optical table.

ometer is one of such examples. The fibre mode size serves as the spatial resolution of the device. The spatial resolution and the propagation properties of the endlessly single mode photonic crystal fibre were studied in broad spectral range, from 450 to 1000nm. This was achieved by scanning the focused spot behind high NA Schwarzschild's all-reflective microscope objective, which spot size is smaller than the mode size. The fibre mode and field behind the microscope objective were calculated numerically. The peculiar wavelength dependent patterns obtained experimentally were in good agreement with simulation results and the pattern formation principles were elaborated.

Besides optical fibres, transverse localization of light is also possible in free space. As an example of such propagation of light are the nondiffractive waves. Airy beams appear to resist diffraction and furthermore, the main intensity maximum of an Airy beam follows a parabolic trajectory. Recently, so-called hyperbolic Airy beams have been proposed, whose trajectory is in the form of a hyperbolic function. We have experimentally measured white-light hyperbolic Airy beams created with a refractive phase element. We showed that the main intensity lobe of such beams is dispersed transversely due to chromatic aberration. Experiments with a reflective phase element will follow to overcome the chromatic aberration (P.Saari, H.Lukner et al.).

3.5 Laboratory of Nonlinear Control Theory (IoC)

Any dynamical system is fully accessible through one single actuator and related problems.

Whether an autonomous system can be rendered fully accessible through one single actuator is a long-standing open problem, which got some solutions in special cases when additional constraints are considered. It was shown that a solution to the general problem is provided as an easy consequence of the straightening theorem. This solution is innovative for linear time-invariant systems as well and relaxes the well-known cyclicity condition as it involves nonlinear state transformations. The dual problem of designing one single sensor to render a given system observable obtains a similar almost unconditional solution (Ü.Kotta).

Relaxing realizability conditions for discrete-time nonlinear systems.

Two related topics were addressed. First, a nonrealizable set of input-output equations can be made realizable in the classical state space form by adding a postcompensator whereas this is impossible in the continuous-time case. Construction of such postcompensator of minimal order was presented. Second, a general subclass of discrete-time systems was suggested, for

which the observable subspace is non-integrable. The construction is based on the nonrealizable system, which is realized by adding a postcompensator, and then combined with the output of the original system (Ü.Kotta, M.Tönso).

Integrability conditions in case of nonlinear time-delay systems.

In the case when one works with time-delay systems, the tools used for delay-free systems, do not work anymore, because of the infinite dimension of time-delay systems. First, two definitions of integrable differential one-forms were given and then necessary and sufficient conditions were derived to check if a given set of one-forms is integrable. These concepts of integrability were used to study the accessibility of time-delay systems and a possibility to transform a system into certain normal form (A.Kaldmäe).

Feedback linearization of non-smooth systems.

The algebraic approach known under the name “functions’ algebra” was used to develop necessary and sufficient conditions for existence of a state transformation and static state feedback, which linearize the system equations. The advantage of this method is that it allows to consider also non-smooth systems. The main object in “functions’ algebra” is the set of vector functions, divided into equivalence classes, which form a lattice. Both, discrete- and continuous-time cases are considered and the solutions to the feedback linearization problem are expressed in terms of a finite sequence of vector functions, which contain all the independent functions having certain relative degrees (A.Kaldmäe, Ü.Kotta).

Input-output decoupling of discrete-time control systems by measurement feedback.

The input-output decoupling problem for discrete-time nonlinear systems was studied. The algebraic method based on difference algebra and differential forms was used to solve the problem by measurement feedback, which depends only on a finite number of measured functions. Easily verifiable necessary and sufficient solvability conditions are given separately for cases when the system is described by the state equations or by the input-output equations. By specifying the measured functions, one obtains the conditions either for the output or the state feedback. In the last case, the conditions reduce to previously known results (A.Kaldmäe, Ü.Kotta).

Flatness for discrete-time systems.

New necessary and sufficient condition was found for flatness property of discrete-time nonlinear control systems, which is based on transforming system into certain form, which allows to reduce the number of state equations. The advantage of this method is that it is relatively easy to make all the necessary computations (A.Kaldmäe, Ü.Kotta).

Robust pole assignment via Routh rays of polynomials.

A problem of constructive procedure for robust output controller design was studied for continuous-time linear systems. The approach was based on the so-called reduced Routh parameters that are used to construct stable Routh rays and corresponding Routh cones of polynomials (polyhedral Routh cones), which approximate stability domain. The obtained region is used to design a fixed order controller. The procedures of pole placement and robust controller synthesis are described in the form of step-by-step algorithm (Ü.Nurges, J.Belikov).

Newton observer for a nonlinear flux-controlled AMB system.

Active magnetic bearing (AMB) applications are frequently controlled by feedback, depending on the magnetic flux. The flux measurement is complicated and requires additional sensors to be integrated mechanically into the AMB poles. Therefore, engineers examine the potential of the so-called “sensor-less” control, where the traditional sensors are replaced by a signal from the dynamic estimator (see Figure 9), and, nowadays, the “self-sensing” magnetic bearing technology is applied in many commercial applications. In particular, the flux estimation enables to eliminate the expensive magnetic flux sensors, associated with flux-controlled AMB system. It has been found that position and speed signals may be used to estimate the electrical information

as magnetic flux. The main result of the research was the adaptation of the Newton observer for estimation of the magnetic flux in the feedback control of a nonlinear AMB system (see Fig. 9). The Newton observer was constructed for the exact discrete-time model of the AMB system and was presented in a detailed and simple algorithm, ready for implementation. The Newton observer was combined with three controllers and the effectiveness of the Newton observer-based control scheme was verified by means of numerical simulations, performed within the Matlab environment (Ü.Kotta, V.Kaparin).

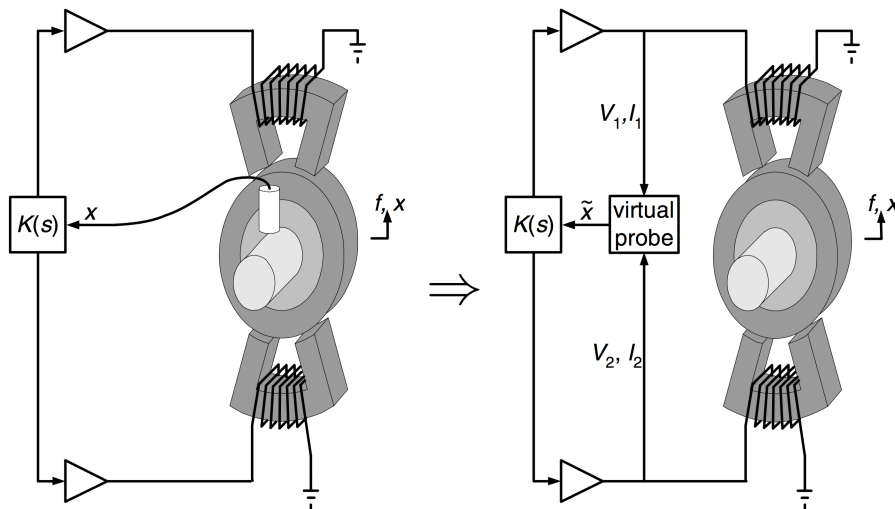

Figure 9: Conventionally sensed and “self-sensing” configurations of AMB.

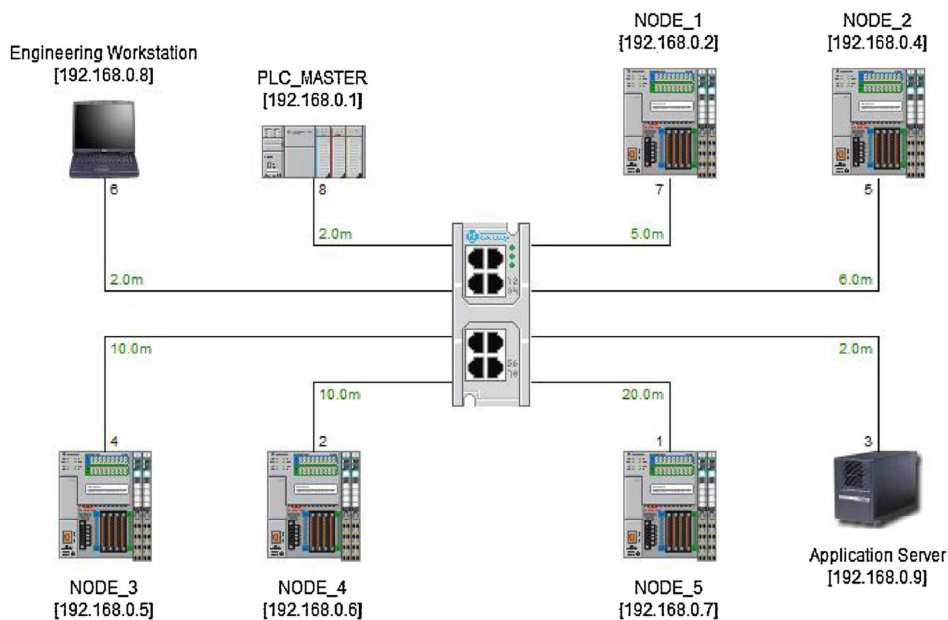

Figure 10: Experiment for determining network delay.

Model checking response times in networked automation systems using jitter bounds.

Response time (RT) of Networked Automation Systems (NAS) is affected by timing imperfections induced due to the network, computing and hardware components. Guaranteeing RT in the presence of such timing imperfections is essential for building dependable NAS, and to avoid

costly upgrades after deployment in industries. This investigation proposes a methodology and work-flow that combines modelling, simulation, verification, experiments, and software tools to verify the RT of the NAS during the design, rather than after deployment (see Fig. 10). The RT evaluation work-flow has three phases: model building, modelling and verification. During the model building phase component reaction times are specified and their timing performance is measured by combining experiments with simulation. During the modelling phase, component based mathematical models that capture the network architecture and inter-connection are proposed. Composition of the component models gives the NAS model required for studying the RT performance on system level. Finally, in the verification step, the NAS formal models are abstracted as UPPAAL timed automata with their timing interfaces. To model timing interfaces, the action patterns, and their timing wrapper are proposed. The formal model of high level of abstraction is used to verify the total response time of the NAS where the reactions to be verified are specified using a subset of timed computation tree logic (TCTL) in UPPAAL model checker. The proposed approach is illustrated on an industrial steam boiler deployment (J.Vain).

3.6 Research within international programmes

3.6.1 Estonian-Polish joint research project ”Algebraic methods in nonlinear control” 2013–2015 under the agreement on scientific cooperation between the Estonian Academy of Sciences and the Polish Academy of Sciences (Estonian project coordinator: Ü.Kotta).

3.6.2 Tempus SESREMO project “Strengthening education in space-based remote sensing for monitoring of eco systems in Israel, Azerbaijan, Kazakhstan” (543720-TEMPUS-1-2013-1-DE-TEMPUS-JPCR, 01.11.2013 – 31.10.2016), led by Technische Universität Berlin (Germany); partners: University of Twente (The Netherlands); Tallinn University of Technology (Estonia); Engineering, Consulting and Management Office (Germany); National Aviation Academy (Azerbaijan); Sumgait State University (Azerbaijan); Baku State University (Azerbaijan); Tel-Aviv University (Israel); Israel Institute of Technology (Israel); Jerusalem College of Engineering (Israel); Al-Farabi Kazakh National University (Kazakhstan); L.N.Gumilev Eurasian National University (Kazakhstan); Korçyt Ata Kyzylorda State University (Kazakhstan); Centre for Remote Sensing and GIS “TERRA” (Kazakhstan); U.Sultangazin Space Research Institute (Kazakhstan); EkoSfera “Social-Ecological Center” (Azerbaijan); Ministry of Education & Science of the Republic of Kazakhstan; Israeli Space Agency at Ministry of Science; Ministry of Education of the Republic of Azerbaijan; Ministry of Environmental Protection of Israel; Participating Scientists: I.Didenkulova, T.Torsvik, T.Soomere, A.Rodin.

3.6.3 Estonian-Polish joint research project ”Algebraic methods in nonlinear control” 2013 – 2015 under the agreement on scientific cooperation between the Estonian Academy of Sciences and the Polish Academy of Sciences (Estonian project coordinator: Ü.Kotta).

3.6.4 Estonian-France joint research on ”Computer algebra, symbolic computation and automatic control” within G.F.Parrot programme (Estonian project coordinator: M.Tõnso).

4. Funding

4.1 Funding through the Archimedes Foundation

1. Funding from the programme "Estonian Centres of Excellence in Research".

4.2 Estonian Research Council (formerly Estonian Science Foundation) grants

1. P.Saari, Personal Research Funding PUT 369 "Search for new types of nondiffractive accelerating light pulses and their applications" (2014–2017).
2. A.Berezovski, Personal Research Funding PUT 434 "Wave energy redistribution in solids with microstructure" (2014–2017).
3. M.Tõnso, Personal Research Funding grant PUT 481, "Modelling of control systems: theory, algorithms, software" (2014–2017).
4. T.Soomere, grant 9125, "Quantification the reaction of the eastern Baltic Sea coast to changing wave conditions" (2012–2015).
5. M.Vendelin, Institutional research grant IUT 33-7 "Relationships between microstructure, energy transfer, and performance in heart" (2015–2020).
6. T.Soomere, Institutional research grant IUT 33-3 "Wave dynamics for coastal engineering and management" (2015–2020).
7. A.Salupere, Institutional research grant IUT 33-24 "Wave propagation in complex media and applications" (2015–2020).

4.3 International grants

1. SEREIN – Modernization of Postgraduate Studies on Security and Resilience for Human and Industry Related Domains. TEMPUS IV project EACEA N0 35/2012 – J.Vain.
2. MOBILITAS top researcher grant MTT63 "Numerical particle tracking modeling for inhomogeneous turbulent water basins" (2011–2015) – T.Torsvik.
3. MOBILITAS post-doctoral grant MJD270 "Statistics of extreme wave conditions and events for Estonian coastal waters" (2012–2015) – I.Nikolkina.
4. Post doctoral scholarship from Max Planck Institute for the Science of Light. September 2013 – September 2014 with full work load and Sept. 2014 – Sept. 2015 with reduced work load, in Erlangen, Germany – H.Lukner.
5. TEMPUS project "Strengthening Education in Space-based REMOte sensing for monitoring of ecosystems in Israel, Azerbaijan, Kazakhstan"(SESREMO, 20 partners), 543720-TEMPUS-1-2013-1-DE-TEMPUS-JPCR (2013–2016) – I.Didenkulova, T.Soomere.
6. The European Economic Area Financial Instrument 2009–2014 Programme: National Climate Policy, Small Grants Scheme Project "Effects of Climate Changes on Biodiversity in the Coastal Shelves of the Baltic Sea" (2015–2016) – T.Soomere.

4.4 Supportive grants (travel, etc)

1. H.Herrmann. Euromech grant to organize Euromech Colloquium 582.
2. A.Stulov, The European Regional Development Fund (Project TK124 (CENS)), and the Estonian Ministry of Education and Research (Project IUT33-24).
3. D.Kartofelev, Doctoral Studies and Internationalisation Programme "DoRa", Archimedes Foundation. May 2015.
4. J.Belikov, Doctoral School in Information and Communication Technology (IKTDK) grant for attending HYCON-EECI Graduate School on Control, Paris, France, 25.05.15–29.05.15.
5. A.Kaldmäe, Activity 6 of the ESF DoRa travel grant for visiting co-supervisor C.H.Moog in IRCCyN, Nantes, France, 1.10.15–30.11.15.
6. H.Lukner, Participation in EURAMET's international project "Metrology for the photonics industry – optical fibres, waveguides and applications".
7. P.Piksarv, Estonian Research Council's grant "Shaping light for advanced light sheet microscopy" for 2-year postdoctoral work in St.-Andrews University, Scotland.
8. H.Lukner, Post doctoral scholarship from Max Planck Institute for the Science of Light from September 2013 until September 2014 with full work load and from Sept. 2014 until Sept. 2016 with reduced work load, in Erlangen, Germany.

4.5 Total income of CENS in 2011 – 2015(Euros)

Source	2011	2012	2013	2014	2015
Targeted financing (TF) ¹	610660	613780	484790	23519	0
Institutional research grants IUT	0	0	0	0	257000
EstRC (former ESF) grants ²	187414	132662	70976	63133	199752
External project funding ^{*3}	526698	508405	554454	353801	313225
EU Structural Funds ⁴	29656	314000	295926	843358	1362167
Grand total	1354428	1568847	1406146	1283511	2132144

Remarks:

* EU Structural Funds excluded.

¹ Targeted financing is used to support evaluated R&D research topics (both basic and applied) from State budget through the Ministry of Education and Research (until 2014).

² EstRC (ESF) grants are available to individuals as well as research groups who have to undergo a research project financing competition (from 2014 Personal Research Funding – PUT) .

³ External project funding – R&D grants from and contracts with various Estonian and foreign institutions (Wellcome Trust, Humboldt Foundation, Marie Curie actions, etc).

⁴ EU Structural Funds for supporting R&D activities implemented through the Archimedes Foundation (Implementation Agency of Structural Support), programme for Centres of Excellence in Research.

5. Publicity of Results

5.1 Publications

5.1.1 Books, theses

1. J.Engelbrecht. Questions about Elastic Waves. Springer, Chan, Heidelberg et al., 2015.
2. J.Engelbrecht (koost.), T.Kändler (toim.). Keeruka maailma võlu. (Charm of Complex World), CENS, Tallinn, 2015 (in Estonian).
3. J.Engelbrecht (Ed.) CENS Highlights 2011–2015. CENS, Tallinn, 2015.
4. A.Berezovski, K.Tamm, T.Peets (Eds.). Proc. of 28th Nordic Seminar on Computational Mechanics: 22–23 October, Tallinn, 2015, CENS, Institute of Cybernetics at TUT.
5. A.Salupere, G.A.Maugin. (Eds.) Proc. Estonian Acad. Sci. Special issue on complexity of nonlinear waves, 2015, 64, 3, 201-322, 323-456.
6. H.Herbert, A.Armigliato, I.Didenkulova. (Eds.). Natural Hazards and Earth System Sciences. Special issue "Progress in tsunami science in light of the 2004 and 2011 tsunamis". Copernicus Publications.
7. A.Giudici. Quantification of Spontaneous Current-Induced Patch Formation in the Marine Surface Layer. PhD thesis, TUT Press, Tallinn, 2015, 141 pp.
8. A.Rodin. Propagation and Run-up of Nonlinear Solitary Surface Waves in Shallow Seas and Coastal Areas. PhD thesis, TUT Press, Tallinn, 2015, 161 pp.
9. E.Pastorelli. Analysis and 3D Visualisation of Microstructured Materials on Custom-Built Virtual Reality Environment. PhD thesis, TUT Press, Tallinn, 2015, 115 pp.
10. N.Karro. Analysis of ADP Compartmentation in Cardiomyocytes and Its Role in Protection Against Mitochondrial Permeability Transition Pore Opening. PhD thesis, TUT Press, Tallinn, 2015, 118 pp.
11. M.Kalda. Mechanoenergetics of a Single Cardiomyocyte. PhD thesis, TUT Press, Tallinn, 2015, 99 pp.

5.1.2 Papers (refereed)

Laboratory of Nonlinear Dynamics

1. S.Ainsaar, J.Kalda. On the effect of finite-time correlations on the turbulent mixing in smooth chaotic compressible velocity fields. Proc. Estonian Acad. Sci., 2015, 64(1), 1-7.
2. J.Engelbrecht, M.Kutser. Legacy of Nikolai Alumäe: theory of shells. Proc. Estonian Acad. Sci., 2015, 64, 2, 139-145.
3. J.Engelbrecht, K.Tamm, T.Peets. On mathematical modelling of solitary pulses in cylindrical biomembranes. Biomechanics and Modeling in Mechanobiology, 2015, 14, 1, 159-167.
4. J.Engelbrecht. Complexity in engineering and natural sciences. Proc. Estonian Acad. Sci., 2015, 64, 3, 249-255.
5. J.Engelbrecht, A.Berezovski. Reflections on mathematical models of deformation waves in elastic microstructured solids. Math. Mech. Compl. Systems, 2015, 3, 1, 43-82.

6. A.Berezovski, J.Engelbrecht. Single slit diffraction: from optics to elasticity. *Wave Motion*, 2016, 60, 35-45.
7. A.Berezovski, J.Engelbrecht, M.Berezovski. Pattern formation of elastic waves and energy localization due to elastic gratings. *Int. J. Mech. Sci.*, 2015, 101-102, 137-144.
8. A.Berezovski, I.Giorgio, A.Della Corte. Interfaces in micromorphic materials: Wave transmission and reflection with numerical simulations (online first). *Mathematics and Mechanics of Solids*, 2015, 1-15.
9. A.Berezovski, P.Ván. Microinertia and internal variables (online first). *Cont. Mech. Thermodyn.*, 2015, 1-11.
10. A.Berezovski. Nonlinear dispersive wave equations for microstructured solids. *Proc. Estonian Acad. Sci.*, 2015, 64, 3, 203-211.
11. R.Kolman, A.Berezovski, S.S.Cho, J.Kopačka, D.Gabriel, K.Tamm, J.Plešek, K.-C.Park. Comparison of several numerical methods in one-dimensional discontinuous elastic wave propagation. *Proc. 28th Nordic Seminar on Computational Mechanics*, Oct. 22-23, 2015, Tallinn, Estonia, TUT, pp. 89–92.
12. A.Braunbrück, A.Ravasio. Nonlinear wave propagation and reflection – comparing the numerics with the analytics. *Wave Motion*, 2015, 52, 1-34.
13. M.Eik, H.Herrmann, J.Puttonen. Orthotropic constitutive model for steel fibre reinforced concrete: linear-elastic state and bases for the failure. In: *Proc. XII Finnish Mechanics Days: 4-5 June 2015, Tampere, Finland*, (Eds.) R.Kouhia et al. Helsinki, Finnish Association for Structural Mechanics, 2015, 255-260.
14. H.Herrmann, A.Lees, E.Pastorelli. Theory and simulation of short fibre reinforced composites. In: *Proc. 6th Int. Conf. Mechanics and Materials in Design [M2D2015]: P.Delgada/Portugal, 26-30 July 2015*, (Eds.) J.F.Silva Gomes, S.A.Meguid, 2015, 2237-2238.
15. H.Herrmann, A.Lees, M.Krause, M.Padilla, E.Pastorelli. Rheology-simulation of short fibre reinforced concrete casting. In: *Proc. 6th Intern. Conf. Mechanics and Materials in Design, P.Delgada/Portugal, 26-30 July 2015*, (Eds.) J.F.Silva Gomes, S.A.Meguid, 2015, 793-794.
16. H.Herrmann, K.Kasepõld, I.Zaitseva-Pärnaste, E.Pastorelli, I.Didenkulova. Photogrammetry based methodology for construction of a first reference 3D model of Pakri Cliff for future monitoring of coastal changes and hazard assessment for Pakri lighthouse. *Baltic Horizons*, 2015, 23 (120), 57-63.
17. E.Pastorelli and H.Herrmann. Virtual reality visualization for short fibre orientation analysis. In: *Proc.14th Biennial Baltic Electronics Conf. (BEC 2014)*, Tallinn, Estonia, 2014, 201-204 (published on IEEE in 2015).
18. M.Eik, J.Puttonen, and H.Herrmann. An orthotropic material model for steel fibre reinforced concrete based on the orientation distribution of fibres. *Composite Structures*, 2015 121(0), 324-336.
19. T.Torsvik, H.Herrmann, I.Didenkulova, and A.Rodin. Analysis of ship wake transformation in the coastal zone by use of timefrequency methods. *Proc. Estonian Acad. Sci.*, 2015, 64(3S), 379-388.

20. F.Ricciardi, E.Pastorelli, L.T. De Paolis, and H.Herrmann. Scalable medical viewer for virtual reality environments. In: L.Tommaso De Paolis and A.Mongelli (Eds.), *Augmented and Virtual Reality*, vol. 9254 of *Lecture Notes in Computer Science*, Springer Int. Publ., 2015, 233-243.
21. H.Herrmann. A constitutive function for the heat flux in short fibre reinforced composites. *J. Non-Equilibrium Thermodynamics*, 2015, 40(4), 257-263.
22. A.Stulov. Piano hammer-string contact duration: How the bass hammer is released from the string. In: *Proc. Third Vienna Talk on Music Acoustics*, 16-19 Sept. 2015, University of Music and Performing Arts Vienna: University of Music and Performing Arts Vienna, 2015, 172-175.
23. D.Kartofelev, A.Stulov, V.Valimaki. Pitch glide effect induced by a nonlinear string-barrier interaction. In: *Proc. 20th Int. Symp. Nonlinear Acoustics ISNA 2015*, 29 June – 3 July, 2015, Ecully, France, pp. 030004-1-030004-4.
24. K.Tamm, T.Peets, D.Kartofelev. Nonlinear pulse propagation in microstructured materials in case of the negative group velocity. In: *Proc. 3rd ECCOMAS Young Investigators Conference YIC2015*, 20-23 July, 2015, Aachen, Germany, pp. 1-4.
25. D.Kartofelev, A.Stulov. Wave propagation and dispersion in microstructured wool felt. *Wave Motion*, Vol. 57, pp. 23-33.
26. A.Stulov, V.Erofeev. Shock wave propagation in nonlinear microstructured wool felt. *Proc. Estonian Acad. Sci.*, Vol. 64(3S), 361-367.
27. J.Janno, A.Šeletski. Reconstruction of coefficients of higher order nonlinear wave equations by measuring solitary waves. *Wave Motion*, 2015, 52, 15-25.
28. J.Kalda, M.Kree. Implications of the theory of turbulent mixing for wave propagation in media with fluctuating coefficient of refraction. *Proc. Estonian Acad. Sci.*, 2015, 64, 3, 285-290.
29. D.Kartofelev, A.Stulov. Wave propagation and dispersion in microstructured wool felt. *Wave Motion*, 2015, 57, 23-33.
30. M.Lints, A.Salupere, S. Dos Santos. Simulation of solitary wave propagation in carbon fibre reinforced polymer. In: *Proc. Estonian Acad. Sci.*, 2015, 64, 3, 297-303.
31. T.Peets, K.Tamm, J.Engelbrecht. Numerical investigation of mechanical waves in biomembranes. In: *Conf. Proc. YIC GACM 2015*, 3rd ECCOMAS Young Investigators Conf., 6th GACM Colloquium, July 20-23, 2015, Aachen, Germany, (Eds.) S.Elgeti, J.-W.Simon, 2015, 1-4.
32. T.Peets, K.Tamm. On mechanical aspects of nerve pulse propagation and the Boussinesq paradigm. *Proc. Estonian Acad. Sci.*, 2015, 64, 3S, 331-337.
33. A.Stulov, V.Erofeev. Shock wave propagation in nonlinear microstructured wool felt. *Proc. Estonian Acad. Sci.*, 2015, 64, 3S, 361-367.
34. K.Tamm, T.Peets. On solitary waves in case of amplitude-dependent nonlinearity. *Chaos, Solitons & Fractals*, 2015, 73, 108-114.
35. K.Tamm, T.Peets. Numerical simulation of mechanical waves in biomembranes. In: *Proc. 28th Nordic Seminar on Computational Mechanics*, Oct. 22-23, 2015, Tallinn, Estonia, TUT, 179182.

36. K.Tamm, T.Peets, D.Kartofelev. Nonlinear pulse propagation in microstructured materials in case of the negative group velocity. In: Conf. Proc. YIC GACM 2015, 3rd ECCOMAS Young Investigators Conference, 6th GACM Colloquium, July 20-23, 2015, Aachen, Germany,(Eds.) S.Elgeti, J.-W.Simon, 2015, 1-4.

Laboratory of Photoelasticity

37. H.Aben, D.Locheignies, Y.Chen, J.Anton, M.Paemurru, M.Õis. A new approach to edge stress measurement in tempered glass panels. *Experimental Mechanics*, 2015, 55, 2, 483-486.

Laboratory of Systems Biology

38. M.Kalda, P.Peterson, M.Vendelin. Cross-bridge group ensembles describing cooperativity in thermodynamically consistent way. *PLoS ONE*, 2015, 10(9), e0137438, 1-26.
39. O.Bragina, K.Gurjanova, J.Krishtal, M.Kulp, N.Karro, V.Tõugu, P.Palumaa. Metallothionein 2A affects the cell respiration by suppressing the expression of mitochondrial protein cytochrome c oxidase subunit II. *J. Bioenergetics and Biomembranes*, 2015, 47(3), 209-216.

Laboratory of Wave Engineering

40. I.Bagdanavičiūtė, L.Kelpšaitė, T.Soomere. Multi-criteria evaluation approach to coastal vulnerability index development in micro-tidal low-lying areas. *Ocean & Coastal Management*, 2015, 104, 124-135.
41. N.Delpeche-Ellmann, T.Torsvik, T.Soomere. Tracks of surface drifters from a major fairway to marine protected areas in the Gulf of Finland. *Proc. Estonian Acad. Sci.*, 2015, 64(3), 226-233.
42. O.Didenkulov, I.Didenkulova, E.Pelinovsky. Parameterization of run-up characteristics for long bell-shaped solitary waves propagating in a bay of parabolic cross-section. *Proc. Estonian Acad. Sci.*, 2015, 64(3), 234-239.
43. M.Eelsalu, T.Soomere, K.Julge. Quantification of changes in the beach volume by the application of an inverse of the Bruun Rule and laser scanning technology. *Proc. Estonian Acad. Sci.*, 2015, 64(3), 240-248.
44. O.E.Kurkina, A.A.Kurkin, E.A.Rouvinskaya, T.Soomere. Propagation regimes of interfacial solitary waves in a three-layer fluid. *Nonlin. Proc. Geophys.*, 2015, 22(2), 117-132.
45. O.E.Kurkina, A.A.Kurkin, E.A.Rouvinskaya, T.Soomere. Propagation regimes of interfacial solitary waves in a three-layer fluid. *Nonlin. Proc. Geophys.*, 2015, 2(1), 1-41.
46. K.E.Parnell, T.Soomere, L.Zaggia, A.Rodin, G.Lorenzetti, J.Rapaglia, G.M.Scarpa. Ship-induced solitary Riemann waves of depression in Venice Lagoon. *Phys. Lett. A*, 2015, 379(6), 555-559.
47. E.N.Pelinovsky, E.G.Shurgalina, A.A.Rodin. Criteria for the transition from a breaking bore to an undular bore. *Izv. Atmosph. Ocean. Phys.*, 51(5), 530-533.

48. A.Rodin, T.Soomere, K.E.Parnell, L.Zaggia. Numerical simulation of the propagation of ship-induced Riemann waves of depression into the Venice Lagoon. *Proc. Estonian Acad. Sci.*, 2015, 64(1), 22-35.
49. T.Soomere, S.R.Bishop, M.Viska, A.Räämet. An abrupt change in winds that may radically affect the coasts and deep sections of the Baltic Sea. *Climate Research*, 2015, 62(2), 163-171.
50. T.Soomere, M.Eelsalu, A.Kurkin, A.Rybin. Separation of the Baltic Sea water level into daily and multi-weekly components. *Continental Shelf Research*, 2015, 103, 23-32.
51. T.Torsvik, T.Soomere, I.Didenkulova, A.Sheremet. Identification of ship wake structures by a time-frequency method. *J. Fluid Mech.*, 2015, 765, 229-251.
52. B.Viikmäe, T.Torsvik, T.Soomere. Verification of modelled locations of coastal areas exposed to current-driven pollution in the Gulf of Finland by using surface drifters. *Proc. Estonian Acad. Sci.*, 2015, 64(3S), 405-416.
53. I.Didenkulova, O.Didenkulov, E.Pelinovsky. A note on the uncertainty in tsunami shape for estimation of its run-up heights. *J. Ocean Eng. and Marine Energy*, 1(2), 199-205.
54. E.N.Pelinovsky, E.G.Shurgalina, A.A.Rodin. Criteria for the transition from a breaking bore to an undular bore (in Russian). *Izv. RAN. Fizika atmosfery i okeana*, 2015, 51(5), 598-601.
55. B.Hünicke, E.Zorita, T.Soomere, K.S.Madsen, M.Johansson, Ü.Suursaar. Recent change Sea level and wind waves. The BACC II. In: *Second Assessment of Climate Change for the Baltic Sea Basin*. Authors Team (Eds.). Cham: Springer, Ch. 9, 155-185.
56. T.Soomere, N.C.Delpeche-Ellmann, T.Torsvik, B.Viikmäe). Towards a new generation of techniques for the environmental management of maritime activities. In: *Environmental Security of the European Cross-Border Energy Supply Infrastructure*. Culshaw, M.G., Osipov, V.I., Booth, S.J., Victorov, A.S. (Eds.). Springer, 2015, 103-132.
57. T.Torsvik, I.Didenkulova. Ship wake deformation in the surf zone analyzed by use of a time-frequency method. In: *Proc. Twenty-fifth (2015) Int. Ocean and Polar Eng. Conf.*, Kona, Big Island, Hawaii, USA, June 21-26, 2015. Cupertino, Calif: Int. Soc. Offshore and Polar Engin., 2015, 394-399.
58. A.Giudici, T.Soomere. Finnish Meteorological Institute's open data mining tool. In: *Proc of 28th Nordic Seminar on Computational Mechanics*, A.Berezovski, K.Tamm, T.Peets (Eds.), 22-23 October, Tallinn, 2015, CENS, IoC, TUT, 59-62.
59. T.Soomere. Approximate numerical solutions to inverse problems for preventive protection of marine environment. In: *Proc of 28th Nordic Seminar on Computational Mechanics*, A.Berezovski, K.Tamm, T.Peets (Eds.), 22-23 October, Tallinn, 2015, CENS, IoC, TUT, 25-28.
60. B.Viikmäe. Temporal scales for nearshore hits of current-driven pollution in the Gulf of Finland. In: *Proc of 28th Nordic Seminar on Computational Mechanics*, A.Berezovski, K.Tamm, T.Peets (Eds.), 22-23 October, Tallinn, 2015, CENS, IoC, TUT, 187-190.
61. T.Soomere. Extremes and decadal variations in the Baltic Sea wave conditions. In: *Extreme Ocean Waves*, Pelinovsky E., Kharif C. (Eds.), Springer, 2016, 107-140.
62. I.Didenkulova, E.Pelinovsky, A.Sergeeva. Runup of long irregular waves on plane beach. In: *Extreme Ocean Waves*, Pelinovsky E., Kharif C. (Eds.), Springer, 2016, 141-153.

63. A.Rodin, I.Didenkulova, E.Pelinovsky. Numerical study for run-up of breaking waves of different polarities on a sloping beach. In: *Extreme Ocean Waves*, Pelinovsky E., Kharif C. (Eds.), Springer, 2016, 155–172.

Together with Laboratory of Nonlinear Dynamics:

H.Herrmann, K.Kasepõld, I.Zaitseva-Pärnaste, E.Pastorelli, I.Didenkulova. Photogrammetry based methodology for construction of a first reference 3D model of Pakri Cliff for future monitoring of coastal changes and hazard assessment for Pakri lighthouse. *Baltic Horizons*, 23 (120), 57-63 (see N 16).

T.Torsvik, H.Herrmann, I.Didenkulova, A.Rodin. Analysis of ship wake transformation in the coastal zone using time-frequency methods. *Proc. Estonian Acad. Sci.*, 64(3S), 379-388 (see N 19).

Laboratory of Nonlinear Control theory

64. I.Artemchuk, Ü.Nurges, J.Belikov, V.Kaparin. Stable cones of polynomials via Routh rays. In: *PC 2015: The 20th Int. Conf. Process Control*, 9–12 June, 2015, Štrbské Pleso, Slovakia, 255–260.
65. Z.Bartosiewicz, Ü.Kotta, E.Pawłuszewicz, M.Tõnso, M.Wyrwas. Transforming a set of nonlinear input-output equations into Popov form. In: *CDC 2015: The 54th IEEE Conf. Decision and Control*, 15–18 December, 2015, Osaka, Japan.
66. Z.Bartosiewicz, Ü.Kotta, M.Tõnso, M.Wyrwas. Static state feedback linearization of nonlinear control systems on homogeneous time scales. *Math. Control Signals Systems*, 2015, 27(4), 523–550.
67. J.Belikov, M.Halas, Ü.Kotta, C.H.Moog. Model matching problem for discrete-time nonlinear systems. *Proc. Estonian Acad. Sci.*, 2015, 64(4), 457–472.
68. J.Belikov, Ü.Kotta, M.Tõnso. Realization of nonlinear MIMO system on homogeneous time scales. *European J. Control*, 2015, 23, 48–54.
69. J.Belikov, E.Petlenkov. NN-SANARX model based control of a multi tank liquid-level system. *Int. J. Comput. Intelligence Syst.*, 2015, 8(2), 265–277.
70. J.Belikov, A.Tepljakov. On controllability of switched linear systems on time scales. In: *ECC 2015: The 14th European Control Conf.*, 15–17 July, 2015, Linz, Austria, 1736–1741.
71. M.Ciulkin, E.Pawłuszewicz, V.Kaparin, Ü.Kotta. Input-output linearization by dynamic output feedback on homogeneous time scales. In: *MMAR 2015: The 20th Int. Conf. Methods and Models in Automation & Robotics*, 24–27 August, 2015, Miedzyzdroje, Poland, 477–482.
72. J.Ernits, E.Halling, G.Kanter, J.Vain. Model-based integration testing of ROS packages: A mobile robot case study. In: *ECMR 2015: The 7th IEEE European Conf. Mobile Robots*, 2–4 September, 2015, Lincoln, UK, 1–7.
73. A.Kaldmäe, Ü.Kotta, A.Shumsky, A.Zhirabok. Measurement feedback disturbance decoupling in discrete-event systems. *Int. J. Robust Nonlinear Control*, 2015, 25(17), 3330–3348.
74. A.Kaldmäe, Ü.Kotta, A.Shumsky, A.Zhirabok. Faulty plant reconfiguration by measurement feedback: Sensor location. In: *SAFEPROCESS 2015: The 9th IFAC Symp. on Fault Detection, Supervision and Safety of Technical Processes*, 2–4 September, 2015, Paris, France, 1283–1288.

75. A.Kaldmäe, C.H.Moog, C.Califano. Towards integrability for nonlinear time-delay systems. In: MICNON 2015: The 1st IFAC Conference on Modelling, Identification and Control of Nonlinear Systems, 24–26 June, 2015, Saint Petersburg, Russia, 900–905.
76. V.Kaparin, Ü.Kotta. Transformation of nonlinear state equations into the observer form: Necessary and sufficient conditions in terms of one-forms. *Kybernetika*, 2015, 51(1), 36–58.
77. Y.Kawano, Ü.Kotta. On integrability of observable space for discrete-time polynomial control systems. *IEEE Trans. Autom. Control*, 2015, 60(7), 1987–1991.
78. Y.Kawano, Ü.Kotta. On integrability of observable space for discrete-time analytic systems. In: CDC 2015: The 54th IEEE Conference on Decision and Control, 15–18 December, 2015, Osaka, Japan.
79. Y.Kawano, Ü.Kotta, C.H.Moog. Any dynamical system is fully accessible through one single actuator and related problems. *Int. J. Robust Nonlinear Control*, 2015, (early view online).
80. Ü.Kotta, K.Schlacher, M.Tönso. Relaxing realizability conditions for discrete-time nonlinear systems. *Automatica*, 2015, 58, 67–71.
81. Ü.Nurges, S.Avanessov. Fixed-order stabilising controller design by a mixed randomised / deterministic method. *Int. J. Control*, 2015, 88(2), 335–346.
82. S.Srinivasan, F.Buonopane, J.Vain, S.Ramaswamy. Model checking response times in networked automation systems using jitter bounds. *Computers in Industry*, 2015, 74, 186–200.
83. A.Tepljakov, E.A.Gonzalez, E.Petlenkov, J.Belikov, C.A.Monje, I.Petráš. Incorporation of fractional-order dynamics into an existing PI/PID DC motor control loop. *ISA Transactions*. (early view online)
84. A.Tepljakov, E.Petlenkov, J.Belikov. Robust FOPI and FOPID controller design for FFOPDT plants in embedded control applications using frequency-domain analysis. In: ACC 2015: American Control Conf., 1–3 July, 2015, Chicago, IL, USA, 3868–3873.
85. A.Tepljakov, E.Petlenkov, J.Belikov. FOPID controller tuning for fractional FOPDT plants subject to design specifications in the frequency domain. In: ECC 2015: The 14th European Control Conf., 15–17 July, 2015, Linz, Austria, 3502–3507.
86. D.Truscan, J.Vain, M.Koskinen, J.Iqbal. A tool-supported approach for introducing aspects in UPPAAL timed automata. In: A.Holzinger, J.Cardoso, J.Cordeiro, T.Libourel, L.A.Maciaszek, M. van Sinderen (Eds.), *Software Technologies*, vol. 555 of the series *Commun. Comp. and Inform. Sci.*, 349–364, Springer, Switzerland, 2015.
87. Z.Bartosiewicz, J.Belikov, Ü.Kotta, M.Tönso, M.Wyrwas. On the transformation of nonlinear discrete-time input-output system to the strong row-reduced form. *Proc. Estonian Acad. Sci.*, 2016, 65, 1.
88. A.Kaldmäe, C.H.Moog. Disturbance decoupling of time delay systems. *Asian J. Control*, 2016, 18(4), 1–5.
89. A.Kaldmäe, Ü.Kotta, B.Jiang, A.Shumsky, A.Zhirabok. Faulty plant reconfiguration based on disturbance decoupling methods. *Asian J. Control*, 2016, 18(4), 1–10.

90. J.Vain, L.Tsiopoulos, P.Bostöm. Integrating refinement-based methods for developing timed systems. In: *From Action Systems to Distributed Systems: The Refinement Approach*, (Eds.) L.Petre, E.Sekerinski. CRC Press, Taylor & Francis, 2016, 1-18.

UT Optics Group

91. Z.Yang, P.Piksarv, D.E.K.Ferrier, F.J.Gunn-Moore, K.Dholakia. Integrated 3D macro-trapping and light-sheet imaging system. In: Dholakia, K.; Spalding, G.C. (Eds) *Proc. SPIE Optical Trapping and Optical Micromanipulation XII*; San Diego, California, United States, 2015, SPIE, 95480T.
92. Z.Yang, P.Piksarv, D.E.K.Ferrier, F.J.Gunn-Moore, K.Dholakia. Macro-optical trapping for sample confinement in light sheet microscopy. *Biomed. Optics Express*, 2015, 8, 2778-2785.

5.2 Other publications

5.2.1 Research Reports

1. Mech 311/15 J.Engelbrecht. Wave Propagation. Overview on studies 1983–2015.
2. Mech 312/15 K.Tamm, M.Lints, D.Kartofelev, P.Simson, M.Ratas, P.Peterson. Practical notes on selected numerical methods with examples.
3. Mech 313/15 J.Engelbrecht, T.Peets, K.Tamm, M.Laasmaa, M.Vendelin. On modelling of physical effects accompanying the propagation of action potentials in nerve fibres.
4. Mech 314/15 CENS – Estonian Centre of Excellence in Research. Bibliography 2011–2015.
5. Mech 315/15 A.Braunbrück. Study on generation of nonlinear longitudinal standing waves in solids.

5.2.3 Submitted papers

1. S.Rendon de la Torre, J.Kalda, R.Kitt, J.Engelbrecht. On the topologic structure of economic complex networks: empirical evidence from large scale payment network of Estonia. *Chaos, Solitons & Fractals* (accepted).
2. A.Salupere. On hidden solitons in KdV related systems. *Mathematics and Computers in Simulation*, 2015 (in press).
3. A.Berezovski, M.Berezovski. Thermoelastic waves in microstructured solids. *Proc. Int. Conf. Continuous Media with Microstructure, CMwM*, 2015 (accepted).
4. R.Kolman, M.Okrouhlík, A.Berezovski. Galerkin based isogeometric analysis in one-dimensional discontinuous elastic pulse propagation. *Appl. Math. Modelling* (submitted).
5. I.Artemchuk, Ü.Nurges, J.Belikov. Robust pole assignment via Routh rays of polynomials. In: *ACC 2016: American Control Conf.*, 6–8 July, 2016, Boston, MA, USA, (submitted).
6. Z.Bartosiewicz, J.Belikov, Ü.Kotta, M.Tönso, M.Wyrwas. On the transformation of a nonlinear discrete-time input-output system to the strong row-reduced form. *Proc. Estonian Acad. Sci.*, (accepted).

7. J.Belikov, Ü.Kotta. Algebraic Approach for Analysis and Control of a Water Tank System. *Inf. Technology and Control*, (submitted).
8. A.Kaldmäe, Ü.Kotta, B.Jiang, A.Shumsky, A.Zhirabok. Faulty plant reconfiguration based on disturbance decoupling methods. *Asian J. Control*, 2016, 18(4), (to be published in 2016).
9. A.Kaldmäe, C.H.Moog. Disturbance decoupling of time delay systems. *Asian J. Control*, 2016, 18(4), (to be published in 2016).
10. A.Kaldmäe, C.Califano, C.H.Moog. Integrability for nonlinear time-delay systems. *IEEE Transactions on Automatic Control*, (accepted).
11. A.Kaldmäe, Ü.Kotta, A.Zhirabok, A.Shumsky. Feedback linearization of possibly non-smooth systems. *Int. J. Control*, (submitted).
12. A.Kaldmäe, Ü.Kotta. Input-output decoupling of discrete-time nonlinear systems by dynamic measurement feedback. *European J. Control*, (submitted).
13. A.Mystkowski, Ü.Kotta, V.Kaparin. Newton observer for a nonlinear flux-controlled AMB system. *European J. Control*, (submitted).
14. Ü.Nurges, J.Belikov, I.Artemchuk. On stable cones of polynomials via reduced Routh parameters. *Kybernetika*, (submitted).
15. J.Vain, L.Tsiopoulos, P.Bostöm. Integrating refinement-based methods for developing timed systems. In L.Petre, E.Sekerinski (Eds.), *From Action Systems to Distributed Systems: The Refinement Approach*, Taylor & Francis (to be published in 2016).
16. H.Herrmann, E.Pastorelli, A.Kallonen, and J.-P.Suuronen. Methods for fibre orientation analysis of x-ray tomography images of steel fibre reinforced concrete.
17. E.Pastorelli, H.Herrmann. Time-efficient automated analysis for fibre orientations in steel fibre reinforced concrete. *Proc. Eston. Acad. Sci.*, (accepted).
18. A.Stulov, V.Erofeev. Frequency-dependent attenuation and phase velocities dispersion of an acoustical wave propagation in the media with damages. In: *Mechanics of Generalized Continua: Springer, (Advanced Structured Materials)* (to be published in 2016).
19. T.Peets. Internal scales and dispersive properties of microstructured materials. *Math. and Comp. in Simulation* (accepted).

5.2.4 Popular science

1. J.Engelbrecht. Nonlinear dynamics and complex systems. *Eesti Vabariigi preemiad*. ETA, Tallinn, 2015, 12-33.
2. J.Engelbrecht. Sustainability of research is carefully kept. *Horisont*, 6, 2015, 56-57.
3. J.Engelbrecht. Preface to the book by T.Puu: *Arts, Sciences and Economics*, Swedbank, Tallinn, 2015, 5-7.
4. P.Saari. Interview to nationwide daily newspaper *Postimees* (Jan. 30, 2015) about slow light.
5. P.Saari. Public lecture 'Physical equations, formulae and richness' given in Oct. 29, 2015 and viewable through ERR (National Broadcasting) website.

6. H.Lukner. Performed as judge in European's best education TV show (according to EBU, 2012) 'Rakett 69' 5th season broadcasted in national TV in spring 2014, and participated on shooting of 6th season.
7. H.Lukner. Presentation "Advances in photonics" in XX meeting of Estonian hobby astronomers, Aug. 13, 2015 in Parksepa, Estonia.
8. H.Lukner. Member of judge panel on Science Show International Cup 2015, Nov. 25, 2015, Tartu.
9. H.Lukner. Interview to science radio-magazine "Labor" in Estonian nationwide radio programme Vikerraadio, 29.11.2015.
10. A.Valdmann. 9 visiting lectures on optical fibres in Estonian high schools.
11. A.Valdmann. Video on optical fibres for the Researcher's Night festival television coverage.
12. A.Valdmann. Lecture 'Light of the 21st century' for the Environmental Board of Estonia (Feb. 23, 2015)
13. T.Soomere. Peadmurdvate merelainete lahendamise: Läänemeri. Soome laht. Merelainete muster ajas. Inimese ja laine liit. In: Engelbrecht, J., Kändler, T. (Toim.). Keeruka maailma võlu (51-58). [Tallinn]: TTÜ, Küberneetika Instituut, (in Estonian).
14. T.Soomere. Rannad kujunevad ümber nädalate või isegi päevadega (Shores react within days or weeks to changing wave conditions). Meie Maa (newspaper of Saaremaa County), 50(5563), 4.03.2015, 5 (in Estonian).
15. T.Soomere. Akadeemia uuendab uurija-professori institutsiooni (Academy reshapes the principles of selection of research professors). Õpetajate Leht (Teachers' Weekly), 11, 27.03.2015, 9 (in Estonian).
16. T.Soomere. Lähituleviku Eesti nägu: doktoriõppe väljakutsed kiiresti muutuv maailmas (The face of future Estonia: challenges of PhD studies in the rapidly changing world). Õpetajate Leht (Teachers' Weekly), 15, 24.04.2015, 8 (in Estonian).
17. T.Soomere. Identifying surface current patterns. In: Mobilitas COMPASS grantees. Estonian Research Council, Tallinn, 13.
18. T.Soomere. Revealing hidden dangers in shallow waters. In: Mobilitas COMPASS grantees. Estonian Research Council, Tallinn, 28.
19. T.Soomere. Kas Eesti polegi teaduspõhine? (Is Estonia a science-based country?). Postimees (The Postman), 230(7524), 05.10.2015, 13 (in Estonian).
20. T.Soomere. Kõrghariduse imperatiiv: majanduse teenrist ühiskonna ja kultuuri veduriks (The imperative of higher education: from providing services to the economy towards driving society and culture). Sirp, 41(3561), 16.10.2015, 6-7 (in Estonian).
21. T.Soomere. Pimedus horisondil (Darkness on the horizon). KesKus, October 2015, 6-7 (in Estonian).
22. T.Soomere. 50 aastat hoiatusi, veel üks kliimakonverents (Fifty years of warnings and another climate conference). Postimees Online, 11.12.2015 (in Estonian).
23. T.Soomere. Mida võib valitsuse haridus- ja teaduspoliitikas 2015. aastal olulisena välja tuua? (The most important aspects of the national policy on education and science in 2015). Sirp, 50(3570), 26 (in Estonian).

24. T.Soomere. Mitte katastroofi- või õhinapõhine, vaid teadus- ja teadmispõhine lähenemine aitab (Science and knowledge-based approach is much better than disaster warnings). Õhtuleht, 19.12.2015, 13 (in Estonian).

5.2.5 Other papers / Science policy

1. J.Engelbrecht. Farewell talk as the Vice-President, 15.10.2014, Eesti Teaduste Akadeemia Aastaraamat XX(47), 2014. Tallinn, 2015, 93-94.
2. J.Engelbrecht. Talk at the General Assembly, 03.12.2014. Ibid, 102-103.
3. J.Engelbrecht. Experience in the Academy over 20 years. Ibid, 279-288.
4. J.Engelbrecht. First year as the President of the Academy in 1995, Sirp, 7 Aug. 2015, 37.
5. J.Engelbrecht. Mittelineaarne dünaamika ja kompleksüsteemid (Nonlinear dynamics and complex systems). Eesti Vabariigi preemiad. Eesti Teaduste Akadeemia, Tallinn, 2015, 12-33.
6. J.Engelbrecht. Hoolega hoitud teadusmõtte järjepidevus (Sustainability of research is carefully kept). Horisont, 6, 2015, 56-57.
7. J.Engelbrecht. Saateks. Raamatus T.Puu: "Kunst, teadus ja majandus" (preface to the book by T.Puu "Arts, Sciences and Economics"), Swedbank, Tallinn, 2015, 5-7.
8. J.Engelbrecht. Aastalõpu mõtteid teadusest (Thoughts on research). Sirp, 18 December, 2015, 50.
9. T.Soomere. The common voice of scientists towards shaping the future of Europa. Environmentally centered joint programming initiatives: where we are and where we are moving? Tallinn Estonian. Acad. Sci., 8 June, 2015.
10. P.Saari. Introductory chapter of the book by H.Martinson "Isolatsioonist akadeemilisse kapitalismi: Eesti Teadusfond 1989–2011" (Estonian Science Foundation 1989–2011).
11. H.Hein, H.Lukner, A.Poom, E.Puman, E.Soomets, K.Suija. "Kavandatavad muudatused õppetöös" (Changes in teaching practice). Poster presentation: Õppejõult õppejõule 2015: Kollegiaalne tagasiside, 14 January, 2015. (Ed.) E.Voolaid, Tartu (in Estonian).

5.3 Conferences

1. CENS Conference 2015, Tallinn, 14 September, 2015.
 J.Engelbrecht. Overview on CENS and N.Alumäe 100.
 J.Kalda. Nonlinear dynamics.
 A.Berezovski. Waves in solids.
 H.Aben. Photoelasticity: demo in the Laboratory.
 T.Soomere. Wave engineering.
 P.Saari. Optics.
 Ü.Kotta. Control theory.
2. Estonian Mechanics Days, Tallinn, 15 September, 2015.
 J.Engelbrecht. Nikolai Alumäe 100.
 M.Kutser. History of the Estonian Mechanics Days.

- K.Tamm. Deformation waves in solids.
 B.Viikmäe. Optimization of fairways in the Gulf of Finland on the patterns of surface currents.
3. European Solid Mechanics Conference (ESMC2015), Madrid, Spain, 6-10 Juni, 2015.
 J.Engelbrecht, A.Berezovski: Wave Interactions in Microstructured Materials.
 4. The XII Hungarian Mechanics Conference, Budapest-Miskolc, Hungary, 25-27 August, 2015.
 J.Engelbrecht, A.Berezovski, P.Van, A.Szekeres. Wave Dynamics and Complexity: Results of the Hungarian-Estonian Cooperation.
 5. The Ninth IMACS International Conference on Nonlinear Evolution Equations and Wave Phenomena: Computation and Theory, Athens, Georgia, April 1-4, 2015.
 A.Salupere. On solitonic structures and discrete spectral analysis.
 T.Peets, K.Tamm, J.Engelbrecht. Mechanical waves in biomembranes.
 K.Tamm, T.Peets, D.Kartofelev. Boussinesq paradigm and negative group velocity in a material with double microstructure.
 6. EUROMECH Colloquium 577: Micromechanics of Metal Ceramic Composites, Stuttgart, Germany March 2-5, 2015.
 H.Herrmann. A comparison of constitutive models for short fibre reinforced brittle materials.
 7. 28th Nordic Seminar on Computational Mechanics, Tallinn, 22-23 October, 2015.
 Plenary talk:
 T.Soomere. Approximate numerical solutions to inverse problems for preventive protection of marine environment.
 Sectional talks:
 K.Tamm, T.Peets. Numerical simulation of mechanical waves in biomembranes.
 H.Herrmann, V.Voelkl, M.A.Beddig. Discrete element simulations of tension and bending tests of short steel fibre reinforced cementitious composites.
 R.Kolman, A.Berezovski, S.S.Cho, J.Kopacka, D.Gabriel, K.Tamm, J.Pleseck, K.-C.Park. Comparison of several numerical methods in one-dimensional discontinuous elastic wave propagation.
 T.Peets, K.Tamm. Wave propagation in hierarchical multiscale microstructured solids and dispersion.
 A.Braunbrück, A.Ravasio. Nonlinear propagation and reflection of ultrasound – combining the numerical and analytical approach.
 M.Lints, A.Salupere, S.Dos Santos. Dispersion simulations in layered CFRP.
 B.Viikmäe. Temporal scales for nearshore hits of currentdriven pollution in the gulf of Finland.
 A.Giudici, T.Soomere. Finnish meteorological institut’s open data mining tool.
 8. International Conference on Continuous Media with Microstructure, CMwM2015, Łagów, 2-5 March, 2015.
 A.Berezovski, M.Berezovski. Thermoelastic waves in microstructured solids.
 9. 68th Annual Meeting of the APS Division of Fluid Dynamics, Boston, Massachusetts, November 22–24, 2015.
 S.Ainsaar, J.Kalda. On the effect of finite-time correlations on the turbulent mixing in smooth chaotic compressible velocity fields.

- J.Kalda, M.Kree. Wave propagation in inhomogeneous media as turbulent mixing in six-dimensional incompressible flow.
- M.Kree, J.Kalda. Rain formation via turbulent mixing of droplet distributions.
10. 12th International Conference on Hole Burning, Single Molecule and Related Spectroscopies: Science and Applications, Tartu, Estonia, 24-27 August, 2015.
J.Kalda. Wave propagation in media with fluctuating coefficient of refraction as chaotic mixing in 6-dimensional phase space.
 11. 3rd ECCOMAS Young Investigators Conference, 6th GACM Colloquium, Aachen, Germany, July 20-23, 2015.
K.Tamm, T.Peets, D.Kartofelev. Nonlinear pulse propagation in microstructured materials in case of the negative group velocity.
T.Peets, K.Tamm, J.Engelbrecht. Numerical investigation of mechanical waves in biomembranes.
 12. 26th IUGG General Assembly 2015, International Union of Geodesy and Geophysics. Institute of Thermomechanics, Prague, Czech Republic, 29 June – 2 July 2015.
T.Peets, K.Tamm, A.Salupere. Double microstructured material model with negative group velocity.
 13. Biophysical Society 59th Annual Meeting. Baltimore, USA, 7-11 February, 2015.
M.Vendelin. 3 poster presentations.
J.Branovets. The influence of adenylate kinase and hexokinase on respiration in creatine-deficient GAMT and AGAT mouse cardiomyocytes.
M.Kalda. Cross-Bridge Group Ensembles Describing Cooperativity in Thermodynamically Consistent Way.
M.Laasmaa, N.Jepihhina, P.Simson. The characterization of diffusion obstacles in rat cardiomyocyte.
 14. 44th European Muscle Conference. Poola, Warsaw, 20-26 August, 2015.
J.Branovets. The influence of adenylate kinase and hexokinase on respiration in creatine-deficient GAMT and AGAT mouse cardiomyocytes.
M.Kalda. Cross-Bridge Group Ensembles Describing Cooperativity in Thermodynamically Consistent Way.
M.Vendelin. The characterization of diffusion obstacles in rat cardiomyocytes.
M.Laasmaa. Calcium fluxes in cardiac excitation-contraction coupling in rainbow trout.
P.Simson. The characterization of diffusion obstacles in rat cardiomyocytes.
 15. European Young Physiologist Symposium FEPS 2015. Lithuania, Kaunas, 25-30 August, 2015.
N.Jepihhina. The characterization of diffusion obstacles in rat cardiomyocytes.
 16. The Joint Meeting of the Federation of European Physiological Societies and the Baltic Physiological Societies. Lithuania, Kaunas, 15-29 August, 2015.
M.Laasmaa. Action potential clamp data analysis reveals large contribution of sarcoplasmic reticulum in excitation-contraction coupling of trout cardiomyocytes.
 17. Algebra and Its Applications, Otepää, Estonia, 10 May, 2015.
Ü.Kotta. Algebraic tools in nonlinear control.
A.Kaldmäe. Feedback linearization of possibly non-smooth control systems using “functions’ algebra”.

18. The 20th International Conference on Process Control (PC 2015), Štrbské Pleso, Slovakia, 9-12 June, 2015.
Ü.Nurges. Stable cones of polynomials via Routh rays.
19. The 1st IFAC Conference on Modelling, Identification and Control of Nonlinear Systems (MICNON 2015), Saint Petersburg, Russia, 24-26 June, 2015.
A.Kaldmäe. Towards Integrability for Nonlinear Time-Delay Systems.
20. The 20th International Conference on Methods and Models in Automation and Robotics (MMAR 2015), Miedzyzdroje, Poland, 24-27 August, 2015.
V.Kaparin. Input-output linearization by dynamic output feedback on homogeneous time scales.
21. The 54th IEEE Conference on Decision and Control (CDC 2015), Osaka, Japan, 15-18 December, 2015.
Ü.Kotta, M.Tönso. Transforming a set of nonlinear input-output equations into Popov form.
Ü.Kotta. On integrability of observable space for discrete-time analytic systems.
22. XII Finnish Mechanics Days, Tampere, Finland, 4-5 June, 2015.
M.Eik, H.Herrmann, J.Puttonen. An orthotropic material model for steel fibre reinforced concrete based on the orientation distribution of fibres.
T.Soomere. Challenges of climatic changes for coastal engineering to the.
23. Euromech Colloquium 577, Stuttgart, Germany, 2-5 March 2015.
H.Herrmann. A comparison of constitutive models for short fibre reinforced brittle materials.
24. Mechanics and Materials in Design, Ponta Delgada, Portugal, 26-30 July, 2015.
H.Herrmann, A.Lees, E.Pastorelli. Theory and simulation of short fibre reinforced composites.
H.Herrmann, M.Krause, M.Padilla, E.Pastorelli. Rheology-simulation of short fibre reinforced concrete casting.
25. Salento AVR 2015, Lecce, Italy, 15-18 June, 2015.
F.Ricciardi, E.Pastorelli, L.T. De Paolis, H.Herrmann. Scalable medical viewer for virtual reality environments.
26. Generalized Continua (GC2015), Magdeburg, Germany, 21-26 September, 2015.
H.Herrmann. About continuum models for short fibre reinforced concrete.
27. NAFEMS NORDIC Seminar: Simulating Composite Materials and Structures, Stockholm, Sweden, 17-18 November, 2015. M.Eik, J.Puttonen, H.Herrmann. Reconstruction Order of the Orientation Distribution Function Depending on Fibres Orientation Distribution Character.
28. Ultrafast Optics (UFO X), Beijing, China, August 16-21, 2015.
A.Valdmann. White-light hyperbolic Airy beams.
29. Northern Optics & Photonics 2015, Lappeenranta, Finland, June 2-4, 2015.
A.Valdmann. Propagation speed and transformation of light into Bessel and Airy pulsed fields in optical elements, as measured with single-cycle temporal resolution.
30. Teaching conference "Õppejõult õppejõule 2015: Kollegiaalne tagasiside", Tartu, 14 January, 2015.
H.Lukner. Participated.

31. The International Seminar Climate Modelling and Impacts: From the Global to the Regional to the Urban scale (HafenCity Universität (HCU), Hamburg, 10 March, 2015.
Poster presentations:
M.Eelsalu, T.Soomere, K.Julge. Quantification of changes in the beach volume by applying an inverse Bruun's Rule and laser scanning technology in Pirita Beach, Tallinn Bay.
K.Pindsoo, T.Soomere. Contribution of wave induced set-up into total water level in the urban area of Tallinn.
A.Giudici, T.Soomere. Identification of areas of spontaneous current-induced surface patch formation in the Gulf of Finland.
32. 47th Liege Colloquium on Ocean Dynamics. Liege, Belgia, 4-8 May, 2015.
T.Torsvik. Analysis of spatial and temporal scales for surface currents in the Gulf of Finland based on surface drifter motion.
B.Viikmäe. Poster presentation: The impact of wind on optimising fairways in the Gulf of Finland.
33. The 16th General Assembly of the (The federation of) All European Academies (ALLEA), Lisbon, Portugal, 23-24 April, 2015.
T.Soomere participated.
34. Meeting of European Academies and their Human Rights Committees. Conference: The Human Right to Science, Bern, Switzerland, 21–22 May, 2015.
T.Soomere. Overview of emerging challenges in human rights in Estonia associated with the electronic means of communication between the state and citizens.
35. ESA Sentinel-3 For Science Workshop. Palazzo del Casino in the Lido, Venice, Italy, 2–5 June, 2015.
N.Delpeche-Ellmann (co-authors T.Torsvik and T.Soomere). Poster: Examining surface circulation patterns of the Baltic Sea using satellite data, ocean models and in-situ observations.
36. Conference Science, technology and innovative technologies in the prosperous epoch of the powerful state, Ashgabat, Turkmenistan, 11–14 June, 2015.
T.Soomere. The use of surface currents for the preventive protection of marine environment.
37. 10th Baltic Sea Science Congress. Riga, Latvia, 15-19 June, 2015.
N.Delpeche-Ellmann, T.Torsvik Examination of the effects of wind induced forcings on surface drifters circulation patterns in the Gulf of Finland.
T.Torsvik, I.Didenkulova, V.V.S.S.R. Hemanth. Measurements of wave transformation in the coastal zone.
K.Pindsoo, T.Soomere. Trends in extreme water levels of the eastern Baltic Sea.
T.Soomere, M.Eelsalu. Separation of the Baltic Sea water level into short-term and multi-weekly components.
M.Eelsalu, T.Soomere, K.Pindsoo, P.Lagemaa. Ensemble approach for the projections of extreme water levels reveals bias in water level observations.
K.Pindsoo, T.Soomere. Contribution of wave set-up into the total water level in the Tallinn area.
O.Kovaleva, B.Chubarenko, D.Ryabchuk. Analysis of sediment transport pattern along the coastal line of the Russian part of the Curonian Spit.
Poster presentations:
B.Viikmäe, T.Soomere, T.Torsvik. Quantification of the impact of wind for optimising fairways in the Gulf of Finland.

- T.Torsvik, B.Viikmäe. Investigation of surface currents near Cape Kolka in the Gulf of Riga by use of surface drifters.
- D.Pupienis, I.Buynovich, D.Jarmalavicius, G.Žilinskas, J.Fedorovic, D.Ryabchuk, O.Kovaleva, A.Sergeev. Spatial pattern in heavy-mineral concentrations on the Curonian Spit sea coast as indicator of human activities and natural processes.
- L.Davulienė, L.Kelpšaitė, T.Torsvik, I.Dailidienė. A study of the sea surface boundary layer dynamics.
- M.Eelsalu, T.Soomere, K.Julge, E.Grünthal. Quantification of the changes in sediment volume in a small beach applying laser scanning technology.
- K.Pindsoo, T.Soomere, M.Eelsalu, H.Tõnisson. Quantification of the impact of vessel wakes on a shingle-gravel beach.
- A.Rodin, I.Didenkulova, E.Pelinovsky. The transformation and run-up of long breaking solitary waves of various polarities on a sloping beach.
- K.E.Parnell, T.Soomere, L.Zaggia, A.Rodin. Numerical study of propagation of ship-induced wave troughs in Venice Lagoon.
- O.Kovaleva, T.Soomere, M.Eelsalu. Comparison of the wave power for the open and sheltered segments of the Baltic Sea coast.
- O.Kovaleva, T.Soomere, M.Eelsalu, D.Ryabchuk. Determination of closure depths for sheltered areas of the eastern part of the Baltic Sea.
- T.Mingėlaitė, M.Eelsalu, K.Pindsoo, T.Soomere, I.Dailidienė. Return periods of extreme water levels along Lithuanian sea coast based on a simple ensemble of projections.
- A.Giudici. Measurement of spontaneous current-induced patch formation processes in the marine surface layer.
38. 25th International Ocean and Polar Engineering Conference, Kona, Big Island, Hawaii, USA 21-26, June 2015.
T.Torsvik, I.Didenkulova. Ship wake deformation in the surf zone analyzed by use of a time-frequency method.
39. 26th General Assembly of the International Union of Geodesy and Geophysics (IUGG). Prague, Czech Republic, 22 June – 2 July 2015.
N.Delpeche-Ellmann. Using surface current-driven Lagrangian transport patterns to mitigate the risk of pollution to Marine Protected Areas in the Baltic Sea.
N.Delpeche-Ellmann. Comparison of simulated and observed Lagrangian drift in the marine surface layer towards Marine Protected Areas in the Baltic Sea, poster presentation (co-authors of both presentations T.Torsvik and T.Soomere).
40. 7th Warnemünde Turbulence Days. Isle of Vilm, Germany, 30 August - 3 September, 2015.
T.Torsvik, N.Delpeche-Ellmann. Wind forcing influence on surface drifter motion in the Gulf of Finland, poster presentation.
41. 7th World Science Forum. Budapest, Hungary, 4–7 November, 2015.
T.Soomere, H.Lukner – participated.
42. Estonian Geophysics 2015. Tõravere, Estonia, 3 December, 2015.
T.Soomere. Fascinating mathematics of extreme water levels of the Baltic Sea.
M.Eelsalu. Perspectives of the use of wave energy of the Baltic Sea.
Poster presentations:
M.Eelsalu. The contribution of wave set-up to extreme water level in the region of Tallinn.
A.Räämet. Ensemble-based reconstruction of the wave climate.
R.Männikus. Quantification of sand transport near the Russalka monument (Tallin) based on laser scanning data and theory of equilibrium beach profile.

5.4 Seminars

5.4.1 Tallinn Seminars on Mechanics (CENS 2015)

1. 12.1.2015 A.Berezovski: Microinertia and internal variables.
2. 14.1.2015 A.Giudici: The Baltic Sea and the role of upwelling and downwelling in the formation of its vertical structure.
3. 2.2.2015. T.Torsvik: Ship wake analysis: Estimating ship speed and distance to sailing track based on geometrical properties of the wake signal.
4. 9.2.2015. A.Stulov: Constitutive equations and wave propagation in microstructured materials.
5. 9.3.2015. M.Kree: Numerical mixing of diffusive strips.
6. 23.3.2015. K.Tamm, T.Peets: Negative group velocity in a material with double microstructure.
7. 30.3.2015. H.Herrmann: Simulations of SFRC flow and new results on material analysis (with E.Pastorelli, A.Lees).
8. 13.4.2015. A.Rodin: The impact of free shallow-water waves on the local water level in the Baltic Sea.
9. 11.5.2015. J.Engelbrecht: Questions about elastic waves.
10. 18.5.2015. M.Patriarca: Diversity-induced effects in complex and condensed matter systems.
11. 11.6.2015. St.Rendon: Scale-free networks: applications to econophysics.
12. 5.10.2015. Prof. U.Schlattner (Joseph Fourier University): Mitochondrial NM23-H4/NDPK-D has dual functions: fueling mitochondrial GTPase OPA1 and triggering mitophagy or apoptosis.
13. 9.11.2015. H.Herrmann: About continuum models and simulations for short fibre reinforced concrete.

5.4.1.1 Seminars of the Wave Engineering Group

1. 21.01.2015. Dr. A.Giudici. Quantification of spontaneous current-induced patch formation in the marine surface layer.
2. 02.02.2015. Dr. T.Torsvik. Ship wake analysis: Estimating ship speed and distance to sailing track based on geometrical properties of the wake signal.
3. 10.02.2015. Reporting seminar
4. 18.02.2015. T.Mingelaite. Space-derived parameters of coastal upwelling in the SE Baltic.
5. 03.03.2015. O.Kovaleva. Research discussion.
6. 10.03.2015. Dr. B.Viikmäe. Quantification of the impact of wind for optimising fairways in the Gulf of Finland.

7. 17.03.2015. Dr. T.Torsvik. Update on drifter analysis.
8. 24.03.2015. Reporting seminar.
9. 30.04.2015. Dr. A.Rodin. Propagation and run-up of nonlinear solitary surface waves in shallow seas and coastal areas.
10. 12.05.2015. Dr. A.Giudici. Presentation about wave generator project with Artem Rodin. General discussion.
11. 02.06.2015. M.Eelsalu, K.Pindsoo. Ensemble approach for the projections of extreme water levels reveals bias in water level observations.
12. 07.07.2015. Prof. Richard Brown and Mr. Kabir Suara (Queensland University of Technology, Brisbane, Australia). Studying Dispersion and Mixing in Tidal Shallow water using High-resolution GPS-drifters.
13. 29.09.2015. Reporting seminar.
14. 13.10.2015. Reporting seminar, general discussion.
15. 21.10.2015. General discussion.
16. 10.11.2015. R.Männikus. Assessment of sediment transport near new Merirahu Port. Modelling suspended sediment transport during dredging in Delft3D.
17. 8.12.2015. Dr. Nadia Kudryavtseva. Variations in the wave climate of the Baltic Sea in the last 25 years from satellite altimetry.
18. 11.12.2015. Mr. Gian Marco Scarpa. (Ca Foscari University, Venice, Italy). Presentation about a field work made in the Venice lagoon that is under the influence of big ship wakes.

5.4.1.2 Seminars Nonlinear Control Group

1. 07.12.2015. Prof. Arūnas Andziulis (Informatics Engineering Department, Klaipeda University, Lithuania): Directions of possible cooperation between Informatics Engineering Department and Laboratory of Control Systems.

5.4.1.3 Seminars of Optics Group

1. Weekly seminar of Laboratory of physical optics.
2. The institute's monthly seminar of photonics.

5.4.2 Lectures and seminars outside CENS

1. J.Engelbrecht. WAAS Webinar (e-conference) on Anticipation, panellist, 13.04.2015.
2. J.Engelbrecht. Nonlinearity and Complex Systems. General Assembly, Estonian Academy of Sciences, Tallinn, 15.04.2015.
3. J.Engelbrecht. WAAS: 3rd Global Baku Forum, on Building Trust in the Emerging World Order, Panel summarizer, Baku, Azerbaijan, 27-30.04.2015.
4. J.Engelbrecht. Modelling the biological systems, Academy of Sciences of Turin, Turin, Italy 18-21.05, 2015.

5. J.Engelbrecht. What is complexity? Club of Rome Estonia. Tallinn, 28.09.2015.
6. J.Engelbrecht Chaos is full of rules. TEDX conference, Tartu, 21.11.2015.
7. A.Berezovski. Elastic wave propagation in microstructured solids June, 16, The seminar of mathematical modelling in the Faculty of Applied Sciences, University of West Bohemia, Plzen.
8. J.Vain. Technological revolution in medicine. Plenary talk at the 8th Congress of the Baltic Association of Surgeons (BAS Congress 2015), Tallinn, Estonia, 10–12 September, 2015.
9. J.Belikov. Polynomials Methods for Nonlinear Control Systems. Technion – Israel Institute of Technology, Haifa, Israel, 26 October, 2015.
10. Ü.Kotta. Relaxing realizability conditions for discrete-time nonlinear systems. Institut de Recherche en Communications et en Cybernétique de Nantes (IRCCyN), 5 November, 2015.
11. H.Lukner. Reporting meetings in Max Planck Institute.
12. A.Giudici, M.Eelsalu and K.Pindsoo. The international seminar Climate modelling and impacts: From the Global to the Regional to the Urban scale (HafenCity Universität (HCU)), Hamburg, 10 March 2015:
Quantification of changes in the beach volume by applying an inverse Bruun’s Rule and laser scanning technology in Pirita Beach, Tallinn Bay (M.Eelsalu, T.Soomere, K.Julge),
Contribution of wave induced set-up into total water level in the urban area of Tallinn (K.Pindsoo, T.Soomere),
Identification of areas of spontaneous current-induced surface patch formation in the Gulf of Finland (A.Giudici, T.Soomere).
13. T.Soomere. Wave dynamics and Lagrangian transport for coastal and maritime engineering about recent research in the Wave Engineering Laboratory to the seminar in the School of Civil Engineering, the University of Queensland (Brisbane, Australia), 14 August 2015.
14. T.Soomere, M.Eelsalu and K.Pindsoo. Seminar in the Faculty of Science and Engineering, Queensland University of Technology (Brisbane, Australia), a selection of research highlights in the Wave Engineering Laboratory, 13 August 2015:
Inverse problem approach to smart use of currents for environmental management of maritime activities (T.Soomere),
Quantification of changes in the beach volume by applying an inverse Bruun’s Rule and laser scanning technology (M.Eelsalu),
Quantification of the impact of vessel wakes to the transport of coarse sediments (K.Pindsoo).
15. T.Soomere presented the public lecture: The smart use of currents for environmental management of marine activities in the College of Marine and Environmental Sciences, James Cook University (Townsville, Australia), 4 September, 2015.
16. Seminar in the University of Sunshine Coast (Sippy Downs, Australia), 10 September, 2015.
M.Eelsalu. Quantification of changes in the beach volume by applying an inverse Bruun’s Rule and laser scanning technology.
K.Pindsoo. Quantification of the impact of vessel wakes to the transport of coarse sediments.

17. Seminar in the School of Civil Engineering, the University of Queensland (Brisbane, Australia), 11 September, 2015.
M.Eelsalu. Quantification of changes in the beach volume by applying an inverse Bruun's Rule and laser scanning technology.
K.Pindsoo. Trends in extreme water levels of the eastern Baltic Sea.
18. T.Soomere presented the opening lecture Kõrghariduse imperatiiv: majanduse teenist ühiskonna ja kultuuri veduriks (The imperative of higher education: from providing services for economy to the driver of society and culture) to the vision conference of the Estonian Art Academy (Conference centre of Riigikogu [the Estonian parliament], Tallinn, Estonia), 18 September, 2015.
19. T.Soomere presented the latest results on ship wake analysis to the research centre UMR Gulliver 7083 (led by Prof. Elie Raphael), The City of Paris Industrial Physics and Chemistry Higher Educational Institution ESPCI, 19 September, 2015. 23. T.Mingelaite, N.Delpeche-Ellmann, T. Soomere presentation in GoF/Baltic Earth PhD seminar, Examining an upwelling event using satellite data and in-situ surface drifters in the Gulf of Finland, 17 November, 2015.

5.5 Meetings and events

5.5.1. Meetings and events in CENS

CENS conference with the IAB, 14 September 2015, Tallinn.

The conference gave an overview on activities of CENS over 2011–2015. The CENS International Advisory Board was invited to attend the meeting and give their opinion on research results (see Annex). All groups presented their results and the visits to laboratories (photoelasticity, systems biology, visualization) demonstrated the experiments. The IAB approved the draft of the final Report (CENS Highlights 2011–2015) which was later published.

The 28th Nordic Seminar on Computational Mechanics, 22–23 October, 2015, Tallinn.

This traditional Conference attracted 63 participants from 12 countries. Altogether 52 talks were given. The Proceedings were published in a separate volume: 28th Nordic Seminar on Computational Mechanics. Tallinn, Estonia, 22–23 October, 2015.

1. T.Soomere. Approximate numerical solutions to inverse problems for preventive protection of marine environment (Plenary lecture).
2. K.Tamm, T.Peets. Numerical simulation of mechanical waves in biomembranes.
3. H.Herrmann, V.Voelkl, M.A.Beddig. Discrete element simulations of tension and bending tests of short steel fibre reinforced cementitious composites.
4. T.Peets, K.Tamm. Wave propagation in hierarchical multiscale microstructured solids and dispersion.
5. A.Braunbrück, A.Ravasio. Nonlinear propagation and reflection of ultrasound – combining the numerical and analytical approach.
6. M.Lints, A.Salupere, Serge Dos Santos. Dispersion simulations in layered CFRP.
7. B.Viikmäe. Temporal scales for nearshore hits of currentdriven pollution in the Gulf of Finland.

8. A.Giudici, T.Soomere. Finnish Meteorological Institute's open data mining tool.

Intense day on Complexity in Marine Research, 27 January, 2015.

Presentations were given by:

1. Prof. Steven R.Bishop: "Concepts, data and models for complex systems" (University College London, UK);
2. Prof. Inga Dailidienė: "Effect of climate change on ice regime of lagoons of the southern and eastern Baltic Sea" (Klaipėda University, Lithuania);
3. Dr. Loreta Kelpšaitė: "Multi-criteria evaluation approach for coastal zone management (Klaipėda University, Lithuania);
4. Prof. Kristofer Döös: "Evaluation and improvements of the TRACMASS time-analytical trajectory scheme for oceanic and atmospheric general circulation models" (Stockholm University, Sweden).

The participants were welcomed by T.Soomere, J.Engelbrecht and A.Salupere.

Intense day on Wave Dynamics in Marine Research, 4 May, 2015.

Presentations were given by:

1. Prof. Peter A.Davies: "Internal solitary waves in stratified fluids" (School of Engineering, Physics and Mathematics, Department of Civil Engineering, University of Dundee, UK);
2. Prof. Efim Pelinovsky: "Analytical theory of long wave breaking in runup stage" (Institute of Applied Physics and Department of Applied Mathematics, Nizhny Novgorod State Technical University, Russian Academy of Sciences, Nizny Novgorod, Russia);
3. Dr. Tatiana Talipova: "Internal solitons and breathers in inhomogeneous ocean" (Institute of Applied Physics and Department of Applied Mathematics, Nizhny Novgorod State Technical University, Russian Academy of Sciences, Nizny Novgorod, Russia);
4. Prof. Stanisław R.Massel: "On the surface waves generation due to glacier calving" (Institute of Oceanology, Polish Academy of Sciences, Sopot, Poland).

The participants were welcomed by T.Soomere, J.Engelbrecht and A.Salupere.

The Wave Engineering Laboratory team organised the **Tempus SESREMO project reporting and planning meeting in Tallinn (Estonian Academy of Sciences and Institute of Cybernetics at Tallinn University of Technology)**.

The team members presented two short master classes to the participants, 12–13 November, 2015.

6. Research and teaching activities

6.1 International cooperation

Nonlinear Dynamics Laboratory:

- Estonian-Hungarian Joint Research Project for 2013–2015 on "Thermal and mechanical phenomena in media with multiscale microstructure," within Estonian Academy of Sciences and Hungarian Academy of Sciences (A.Berezovski, J.Engelbrecht).
- Estonian-Czech Joint Research Project for 2015–2017 on "Advanced numerical modelling of dynamic processes in solids," within Estonian Academy of Sciences and the Academy of Sciences of the Czech Republic (A.Berezovski, J.Engelbrecht, A.Salupere, K.Tamm).
- Agreement of scientific cooperation (2014–2016) on "Micro-macro-interactions in microstructured media" between the Institute for Mechanics, Otto-von-Guericke-University Magdeburg and CENS, Institute of Cybernetics at Tallinn UT.
- Agreement of scientific cooperation (2014–2016) on "Influence of microstructure on dynamic material response" between the International Research Center for Mathematics & Mechanics of Complex Systems (Cisterna di Latina, Italy) and CENS, Institute of Cybernetics at Tallinn UT.
- MoU on research (2013–2015) on "Waves in elastically non-linear solids, shock waves and numerical methods" between Worcester Polytechnic Institute (USA) and CENS, Institute of Cybernetics at Tallinn UT.
- Agreement of scientific cooperation (2013–2015) on "Dynamics of nonlinear and strongly inhomogeneous materials" between Blekinge Institute of Technology (Sweden) and CENS, Institute of Cybernetics at Tallinn UT.
- Agreement of scientific cooperation (2013–2015) on "Crack propagation and damage description" between Tampere University of Technology (Finland) and CENS, Institute of Cybernetics at Tallinn UT.
- Agreement of scientific cooperation (2012–2015) on "Nonlinear wave propagation in complex media" between PRES Centre Val de Loire University (France) and CENS, Institute of Cybernetics at Tallinn UT.
- Mutual cooperation between the Department of Signal Processing and Acoustics (Aalto University, School of Electrical Engineering, Espoo, Finland) and the Institute of Cybernetics at Tallinn University of Technology.

Nonlinear Control Laboratory:

- A.Kaldmäe. Joint PhD studies with Ecole Centrale de Nantes, France.
- Collaboration with (1) Slovak University of Technology: Dr. Miroslav Halás; (2) Institut de Recherche en Communications et en Cybernétique de Nantes (IRCCyN): Prof. Claude H. Moog; (3) Far Eastern Federal University: Prof. Alexey N. Zhirabok; (4) Osaka University: Dr. Yu Kawano; (5) Bialystok University of Technology: Prof. Zbigniew Bartosiewicz, Prof. Ewa Pawłuszewicz, Dr. Małgorzata Wyrwas, Dr. Arkadiusz Mystkowski; (6) Johannes Kepler University Linz: Prof. Kurt Schlacher, Bernd Kolar. Collaboration includes joint publications, exchange visits, seminars for graduate students.
- Collaboration with Åbo Akademi University, Aalborg University, Kharkov University of Avionics, Technical University of Denmark, University of Sannio.

Laboratory of Wave Engineering:

- 29–30.08.2015, T.Soomere, K.Pindsoo and M.Eelsalu participated in the field works organized by James Cook University (supervised by prof. K.Parnell).
- 31.08-1.09.2015, K.Pindsoo and M.Eelsalu participated in the field works organized by James Cook University (supervised by prof. S.Smithers).

6.2 Teaching activities

6.2.1 Courses:

1. J.Engelbrecht – courses in TUT (MSc level):
 - Mathematical modelling.
2. A.Salupere – courses in TUT:
 - Fundamentals of Elasticity;
 - Continuum Mechanics;
 - Theory of Elasticity;
 - Seminars and Special Seminars for MSc and PhD students.
3. J.Kalda – courses at TUT:
 - Electrodynamics YFT0250;
 - Statistical thermodynamics YFT0580.
 - Lecture course "Nonlinear Dynamics" at the University of Tartu (lectures on the dynamics of solitons on 1, 8 April 2015).
4. A.Braunbrück – courses in TUT:
 - Technical Mechanics I;
 - Technical Mechanics II;
 - Statics;
 - Dynamics.
5. H.Herrmann – courses in TUT:
 - IT for Cartography, 12 lectures in the course "Marine Cartography" VMV0140;
 - Simulation of new Materials, in Institute of Physics, TU Chemnitz, Winter 2014/2015.
 - Simulation of Natural Scientific Processes, Institute of Physics, TU Chemnitz, Summer 2015.
6. P.Peterson – courses in TUT:
 - EMR9740 Scientific programming with Python.
7. J.Belikov – courses in TUT:
 - System Theory, ISS0010.
8. J.Vain – courses in TUT:
 - Logic Programming, ITI0021;
 - Formal Methods, ITI0130;
 - Project on Formal Methods, ITI0135;
 - Formal Methods in Embedded Real-Time Systems Development, ITI8530;
 - Software Assurance, ITI8610;

- Special Topics of Formal Methods, ITI9191;
 - Teaching Practice, ITX8500;
 - Practical Training in Information Technology, ITX8511;
 - Doctoral seminar, IXX9601, IXX9602, IXX9603;
 - Doctoral Teaching Practice, IXX9611, IXX962.
9. T.Mullari – courses in TUT:
- Physics, YFR0011, YFR0012, YFR0030;
 - Refresher Course in Physics, YFR0080.

Courses in University of Tartu:

10. P.Saari:
- Quantum mechanics;
 - Advanced quantum mechanics.
11. H.Lukner:
- Physics and technology, lectures on optics.
12. P.Piksarv:
- Practical course in physics III – Optics.
13. A.Valdmann:
- Seminars on optical properties of matter.

6.2.2. Participation in other events, transfer of knowledge:

1. J.Kalda. Esinemine Gustav Adolfi Gümnaasiumis kampaania "Tagasi kooli" raames 23. veebruaril 2015 ettekandega "Füüsikalistest mudelitest ja klaverihäälestajatest Chicagos", (in Estonian).
2. Ü.Kotta and M.Tõnso, visit of Białystok University of Technology (Białystok, Poland) within the cooperation with Prof. Zbigniew Bartosiewicz, Dr. Małgorzata Wyrwas, Prof. Ewa Pawłuszewicz and Dr. Arkadiusz Mystkowski, 12–18 April, 2015.
3. J.Belikov, participation in module "Switched systems and control" (Prof. D.M.Liberzon). HYCON-ECCI Graduate School on Control, Paris, France, 25–29 May, 2015.
4. A.Kaldmäe, visit of Johannes Kepler University Linz (Linz, Austria) within the cooperation with Prof. Kurt Schlacher and Bernd Kolar 2–11 June, 2015.
5. Ü.Kotta, visit of Institut de Recherche en Communications et en Cybernétique de Nantes (Nantes, France) within the cooperation with Prof. Claude H. Moog, 8–19 June and 3–19 November, 2015.
6. M.Tõnso, visit of Institut de Recherche en Communications et en Cybernétique de Nantes (Nantes, France) within the cooperation with Prof. Claude H. Moog, 9–18 June, 2015.
7. J.Belikov, visit of Białystok University of Technology (Białystok, Poland) within the cooperation with Prof. Zbigniew Bartosiewicz and Dr. Małgorzata Wyrwas, 16–20 June, 2015.
8. V.Kaparin, visit of Białystok University of Technology (Białystok, Poland) within the cooperation with Prof. Ewa Pawłuszewicz and Dr. Arkadiusz Mystkowski, 16–19 June, 2015.

9. J.Kalda, M.Kree, participation at the 46th International Physics Olympiad (July 2015, Mumbai, India).
10. J.Kalda, participation at the 16th Asian Physics Olympiad (May 2015, Hangzhou, China).
11. J.Kalda, Academic Advisor of the Saudi Arabian team of the International Physics Olympiad.
12. J.Kalda, M.Kree, training of the Estonian and Finnish teams of the International Physics Olympiad - June 2015.
13. J.Kalda, training of the Estonian and Finnish teams of the International Physics Olympiad (June 2015), Saudi Arabian team of the International Physics Olympiad (lectures in KAUST University in February and May 2015), and Brazilian team of the International Physics Olympiad (lectures in Fortaleza, June 2015).
14. J.Kalda, member of the Syllabus Committee of the International Physics Olympiad; amendments to the new Syllabus were accepted in July 2015 at the 46th International Physics Olympiad in Mumbai.

6.3. Visiting fellows

For shorter period

1. Dr. Peter Ván: Research Institute of Particle and Nuclear Physics, Budapest, Hungary, June 1-6, 2015.
2. Dr. Radek Kolman, Dr. Jiří Plešek, Dr. Dušan Gabriel, Dr. Slavomir Parma: Institute of Thermomechanics, Academy of Sciences of Czech Republic, Prague, Czech Republic, October 21-25, 2015.
3. Dr. Yu Kawano, Kyoto University, Kyoto, Japan, 6–16 May, 2015.
4. Prof. Alexey N. Zhirabok, Far Eastern Federal University, Vladivostok, Russia, 28–30 August, 2015.
5. Prof. Zbigniew Bartosiewicz, Białystok University of Technology, Białystok, Poland, 6–12 September, 2015.
6. Dr. Małgorzata Wyrwas, Białystok University of Technology, Białystok, Poland, 6–12 September, 2015.
7. Francesco Ricciardi, University of Salento, Italy, 1 March – 30 June 2015, (DoRa T5).
8. Dongshuang Zhang, University of Freiberg, Germany, 1 July – 31 August 2015 (DoRa T5).
9. Duc Khoi Do, University of Ulm, Germany, 1 July – 30 September 2015 (DAAD-Rise internship).
10. Veronika Voelkl, OTH Regensburg, Germany, 1 August – 30 September 2015 (ERASMUS internship).
11. Miriam Beddig, Karlsruhe Institute of Technology, Germany, 1 September – 27 October 2015 (ERASMUS internship).
12. Mr. Gian Marco Scarpa, Cà Foscari University, Venice, Italy, 11–15 December 2015.
13. Prof. Eugénio Rocha, University of Aveiro, Portugal, 14–24 October 2015.

14. Prof. Richard Brown and Mr. Kabir Adewale Suara, Queensland University of Technology, Brisbane, 5–8 July 2015.
15. Prof. Peter A. Davies, Fellow of the Royal Society of Edinburgh (School of Engineering, Physics and Mathematics, Department of Civil Engineering, University of Dundee, UK), 3–5 May 2015.
16. Prof. Stanisław R. Massel, Member of the Polish Academy of Sciences, Institute of Oceanology, Polish Academy of Sciences, Sopot, Poland, 3–5 May 2015..
17. Prof. Efim Pelinovsky, Corresponding Member of the Russian Academy of Sciences, 3–5 May 2015.
18. Dr. Tatiana Talipova, Department of Nonlinear Geophysical Processes, Institute of Applied Physics & Department of Applied Mathematics, Nizny Novgorod State Technical University, Nizny Novgorod, Russia, 3–5 May 2015.
19. Prof. Steven R. Bishop, Faculty of Mathematics and Physical Sciences, University College London, UK, 26–29 January 2015.
20. Prof. Kristofer Döös, Department of Meteorology, Stockholm University, Sweden, 26–29 January 2015.
21. Prof. Inga Dailidienė and Dr. Loreta Kelpšaitė, Faculty of Natural Sciences and Mathematics, Klaipeda University, Lithuania, 26–29 January 2015.

For longer periods

1. E.Pastorelli, Italy (PhD student, DoRa support).
2. Monika Ciulkin, PhD student of Bialystok University of Technology, 31 August – 30 October, 2015, Activity 5 of the ESF DoRa programme visiting PhD student under supervision of Ü.Kotta and V.Kaparin.
3. Bernd Kolar, PhD student of Johannes Kepler University Linz, 1 September – 1 October, 2015, Activity 5 of the ESF DoRa programme visiting PhD student under supervision of Ü.Kotta.
4. Ioannis Kornarakis, Krete, Greece, 1 October – 31 March, 2016 (ERASMUS internship).

6.4 Graduate studies

Nonlinear Dynamics:

Promoted:

1. PhD:
E.Pastorelli. Analysis and 3D Visualisation of Microstructured Materials on Custom-Built Virtual Reality Environment (supervisors H.Herrmann, J.Engelbrecht).
2. BSc:
K.Kasepõld. Eesti Mereakadeemia (supervisors H.Herrmann, I.Zaitseva-Pärnaste).

In progress:

1. PhD:
 - M.Lints. Application of solitary waves for nonlinear medical imaging and non destructive testing of materials (supervisors A.Salupere, S.Dos Santos (France)).
 - Sh.Ch.Azizabadi. Nonlinear dynamics of solids: energy transport in deformed crystal lattice and defects formation (supervisors V.Hižnjakov, J.Kalda).
 - S.Ainsaar. Stochastic transport in two- and three-dimensional structures (supervisors J.Kalda, T.Örd).
 - M.Heidelberg. Transfer processes in fluctuating media (supervisors J.Kalda, T.Örd).
 - J.Jõgi. Semiempirical modeling of structure and functional properties relationships of micro- and nanostructured materials (supervisors J.Kalda, A.Romanov, A.Lõhmus).
 - St.Rendon. From theory to application: econophysics and finances (supervisor J.Kalda).
 - I.Mandre. Percolation phenomena in complex systems (supervisor J.Kalda).
 - M.Jürise. Hyper-spectral, radar and acoustic signatures of military objects in battlefield, radiation field and information field integrated model (supervisors M.Tamre, J.Kalda).
 - I.Tufail. Laser ablation and statistical regularities of laser induced breakdown spectroscopy (LIBS) (supervisors J.Kalda, M.Laan).

Laboratory of Systems Biology:

Promoted:

1. PhD:
 - N.Karro. Analysis of ADP compartmentation in cardiomyocytes and its role in protection against mitochondrial permeability transition pore opening (supervisor R.Birkedal).
 - M.Kalda. Mechanoenergetics of a single cardiomyocyte (supervisors M.Vendelin, P.Peterson).

In progress:

1. PhD:
 - J.Branovets. Structural and energetic modifications in cardiomyocytes from mice with modified creatine kinase system (supervisor R.Birkedal).
 - N.Jepihhina. Heterogeneity of energetic parameters in cardiomyocytes (supervisor M.Vendelin).
 - M.Laasmaa. Studies of the relationship between excitation-contraction coupling and energetics on trout cardiomyocytes (supervisors P.Peterson, R.Birkedal).
 - P.Simson. Localization of diffusion restrictions in cardiomyocytes (supervisors P.Peterson, M.Vendelin).
 - M.Mandel. Bioenergetics of mitochondrial dynamics in neurons (supervisors A.Kaasik, M.Vendelin).
2. MSc:
 - M.Poroon. Deconvolution of fluorescence microscopy images (supervisors M.Laasmaa and P.Peterson).

Laboratory of Wave Engineering:

Promoted:

1. PhD:
 - A.Rodin. Propagation and run-up of nonlinear solitary surface waves in shallow seas and coastal areas (supervisors I.Didenkulova and T.Soomere).
 - A.Giudici. Quantification of spontaneous current-induced patch formation in the marine surface layer (supervisor T.Soomere).

In progress:

1. PhD:
 - M.Eelsalu. Quantification of the reaction of Estonian beaches to changing wave loads (supervisors T.Soomere and A.Ellmann).
 - K.Pindsoo. Quantification of wave-driven hazards at the Estonian beaches (supervisor T.Soomere).
 - R.Männikus. The potential of variation of wave loads at the Estonian coasts in changing climate (supervisor T.Soomere).
2. MSc:
 - M.Org.

Control Systems Department:

Promoted:

1. PhD:
 - A.Tepļjakov. Fractional-order calculus based identification and control of complex dynamic systems (co-supervisor J.Belikov).

In progress:

2. PhD:
 - A.Kaldmäe. Advanced design of nonlinear discrete-time and delayed systems (supervisors Ü.Kotta and C.H.Moog).
 - S.Avanessov. Robust adaptive output controller (co-supervisor Ü.Nurges).
 - I.Artemchuk. New output controller design methods via Routh parameters (supervisors J.Belikov and Ü.Nurges).
 - A.Anier. Motion recognition via abstract interpretation (supervisor J.Vain).
 - D.Pal. Model-based test generation for distributed systems (supervisor J.Vain).
 - J.Guin. An expert system to find court cases based on similarities (supervisor J.Vain).
 - J.Irve. Feature Detection and Tracking for Medical (supervisor J.Vain).
 - E.Halling. Distributed intelligent control of cooperative robotic systems (supervisor J.Vain).
 - G.Kanter. Cognitive context-aware planning in autonomous robot systems (supervisor J.Vain).
 - P.Lump. Quality assurance of safety critical software systems using quantitative methods (supervisor J.Vain).
 - K.Sarna. Aspekt-orienteeritud mudelite konstrueerimine hajustestimises (supervisor J.Vain).
 - M.Markvardt. The method of model-based generation of test data for reactive planning testers (supervisor J.Vain).

Optics group:

In progress:

1. PhD
A.Valdmann.

6.5 Distinctions and awards

Fellows:

1. J.Engelbrecht: State Award for lifelong research.
2. J.Engelbrecht: elected to the Academy of Sciences in Turin, Foreign Member.
3. J.Engelbrecht: awarded the professorship on interdisciplinary studies of the Person Centered Approach Institute at the WHO, Rome, Italy.
4. T.Soomere: elected foreign member of the Latvian Academy of Sciences.
5. A.Giudici: presented his idea “Floud, a cloud-based flood monitoring system” at the Tehno Hack 2015 and his team won the special prize from Arrow Electronics Estonia.
6. T.Soomere: received the II class Distinguished Service Order from the Estonian Lutheran Church for his activities towards strengthening of intellectual and spiritual values.
7. H.Aben, J.Anton: German industrial award for Estonian companies.

Students:

1. A.Valdmann, A.Remm, R.Matte: 1st price in photonics, International FAU Open Research Challenge, Erlangen.

6.6 Other activities

6.6.1 Participation on programme committees, reviewing papers:

1. A.Berezovski: Chairman of the 28th Nordic Seminar on Computational Mechanics, October 22-23, 2015, Tallinn, Estonia.
2. A.Berezovski: reviewer for Continuum Mechanics and Thermodynamics, International J.Solids and Structures, Archive of Applied Mechanics, Communications in Applied and Industrial Mathematics, J. Mechanical Engineering, Wave Motion, Meccanica, J. Mechanical Science and Technology.
3. Ü.Kotta: member of the programme committee of the 1st International Conference on Cognitive Computing and Information Processing (CCIP 2015), 3–4 March, 2015, Noida, India.
4. Ü.Kotta: IPC member / associate editor of the 8th IFAC Symposium on Robust Control Design (ROCOND 2015), 8–11 July, 2015, Bratislava, Slovakia.
5. Ü.Kotta: member of the scientific committee of the 21st International Conference on Difference Equations and Applications (ICDEA 2015), 19–25 July, 2015, Białystok, Poland.

6. Ü.Kotta: IPC member of the 1st IFAC Conference on Modelling, Identification and Control of Nonlinear Systems (MICNON 2015), 24–26 June, 2015, Saint Petersburg, Russia.
7. H.Herrmann: reviewer for J. Non-Equilibrium Thermodynamics, ZAMM, Programm Committee of "Salento AVR 2015".
8. T.Soomere: member of the scientific council of the Laboratory of Multiphase Flows at TUT.
9. T.Soomere: member of the commission on science of the TUT Council.

6.6.2. Participation in journal editorial boards:

1. Journal of Theoretical and Applied Mechanics: J.Engelbrecht.
2. Applied Mechanics: J.Engelbrecht.
3. Applied and Computational Mechanics: A.Berezovski, J.Engelbrecht.
4. Continuum Mechanics and Thermodynamics: A.Berezovski.
5. Proceedings of Estonian Academy of Sciences – Ü.Kotta, T.Soomere, J.Engelbrecht, H.Aben.
6. Acta Mechanica et Automatica – Ü.Kotta.
7. Estonia Journal of Engineering – T.Soomere (co-editor).
8. Estonia Journal of Earth Sciences – T.Soomere (co-editor.)
9. Journal of Marine Systems – T.Soomere.
10. Oceanologia – T.Soomere.
11. Boreal Environment Research – T.Soomere.

6.6.3. Participation in professional organizations:

1. IUTAM General Assembly: A.Salupere – member.
2. Nordic Association for Computational Mechanics: A.Berezovski – member of executive committee.
3. EUROMECH – European Mechanics Society: A.Berezovski, J.Engelbrecht, A.Salupere, K.Tamm – members.
4. ISIMM – The International Society for the Interaction of Mechanics and Mathematics: A.Berezovski, J.Engelbrecht – members.
5. Materials Research Society: A.Berezovski – member.
6. Optical Society of America (OSA): P.Saari – senior member.
7. Estonian Physical Society: P.Saari, H.Lukner, J.Kalda – members.
8. Academia Europaea: P.Saari, J.Engelbrecht, T.Soomere – members.
9. IFAC technical committee for nonlinear control systems: Ü.Kotta – member.
10. IEEE TC-CACSD Action Group on Polynomial Methods for Control System Design (chair): Ü.Kotta,

11. Estonian Society of System Engineers (member): J.Belikov.
12. European Geosciences Union: I.Didenkulova – scientific officer of Sea hazard division.
13. European Marine Board: T.Soomere – Estonian representative and vice-chair.
14. Marine Board of the Estonian Academy of Sciences: T.Soomere – chair.
15. EASAC Environmental Steering Panel: T.Soomere – Estonian representative.

6.6.4 Estonian public bodies:

1. The Academic Council of the State President – P.Saari, R.Kitt.
2. The Board of the Estonian Academy of Sciences – T.Soomere (president), P.Saari, J.Engelbrecht.
3. The Council of the Tallinn University of Technology – A.Salupere.
4. The Board of Trustees of the Tallinn University of Technology – R.Kitt.
5. The Council of the University of Tartu – P.Saari.

6.6.5 Science and Politics:

1. T.Soomere participated in the planning meeting of the new object of Estonian national science infrastructure “Infotechnological mobility observatory” with a short presentation about the Wave Engineering Laboratory (Tartu), 22 January, 2015.
2. T.Soomere presented a short opinion on the presentation and discussion of the OECD Public Governance Review Fostering Strategic Capacity across Governments and Digital Services across Borders (Finland and Estonia), Tallinn, Estonian Academy of Sciences, 27 February, 2015.
3. T.Soomere presented the welcome address to the 14th Baltic Conference on Intellectual Cooperation (20.04) and was the chairman of the morning session on 21.04, Riga and Jelgava, Latvia.
4. T.Soomere in the state visit of the President of Estonia T.H.Ilves to Germany. The event included visits to Bayer Pharma, Kiel University and GEOMAR, 18-21 May, 2015.
5. T.Soomere participated in the International Council for Science (ICSU) European Group meeting (Paris, France), 19-20 November 2015. 19-20 November 2015.
6. T.Soomere participated in the 7th World Science Forum (Budapest, Hungary), 4-7 November, 2015.
7. T.Soomere participated in the ExCom meeting and spring plenary meeting of the European Marine Board, Split, Croatia, 13-15 October 2015.
8. T.Soomere participated in the ExCom meeting and spring plenary meeting of the European Marine Board, Ghent, Belgium. T.Soomere was re-elected to the position of Vice-Chair of the Board for 2015-2017, 28-30 April 2015.
9. T.Soomere participated in the meeting of Environmental Steering Panel of the European Academies Scientific Advisory Council (EASAC), Rome, Italy, 27-28 April 2015.
10. T.Soomere and J.Engelbrecht participated in the 16th General Assembly of the (The federation of) All European Academies (ALLEA), Lisbon, Portugal, 23-24 April 2015.

11. T.Soomere welcomed participants of the seminar on science funding and tenure track system organised jointly by the Division of Informatics and Engineering of the Estonian Academy of Sciences and TUT, 25 March 2015.
12. T.Soomere and J.Engelbrecht participated in the lunch-meeting of opinion leaders of Estonian society organised by the daily newspaper Postimees, 10 February 2015.
13. T.Soomere participated in the ExCom meeting of the European Marine Board (Brussels, Belgium), 20 January 2015.

6.6.6. Media reflections / Media outreach

1. 16 December 2015, A longer live-on-air discussion with T.Soomere and the vice-chair of the Ministry of Environment about the decisions of the Paris climate conference and their consequences to Estonia in the broadcast series Vahetund Postimehega (An hour with The Postman) in the radio channel Kuku Raadio.
2. 16 December 2015, A longer live-on-air comment of T.Soomere about problems in science policy and funding of science in the morning broadcast Terevisioon of the national TV channel ETV.
3. 11 December 2015, A citation of T.Soomere about how Estonia should behave responsibly in the light of climate changes was used in the section Strong word of the daily newspaper Postimees, 289(7583), 12.12.2015, p.2.
4. 10 December 2015, The web article: Are digital signatures the true reaction of Estonia to the climate changes? by Marian Männi cited extensively comments of T.Soomere concerning the contribution of Estonia to emissions of greenhouse gases, Eesti Ekspress/Delfi, published 10.12.2015.
5. 10 December 2015, The article: The storm blew over sea and land by Rein Raudvere was mostly based on comments T.Soomere, Maaleht, 50 (1470), 10.12.2015, p. 13.
6. 4 December 2015, A comment of T.Soomere about the approaching storm to the daily newspaper Päevaleht and the internet news portal Delfi, published at 21:12.
7. 3 December 2015, T.Soomere was invited into the live-on-air broadcast The Discussion of the national TV channel ETV.
8. 30 November 2015, T.Soomere provided a comment on the approaching storm to the major news program Aktuaalne Kaamera of the national Russian-language TV channel ETV+.
9. 29 October 2015, An interview of T.Soomere broadcast in the section: We can do that of the broadcast series Huvitaja of the national radio channel Vikerraadio.
10. 5 October 2015, T.Soomere commented on the role of popularisation in the functioning of scientific landscape in Tallinn TV broadcast INFO+.
11. 2 October 2015, A comment by T.Soomere to the radio broadcast Huvitaja of the national radio channel Vikerraadio about potential adverse impacts of the major dredging at Bronka Harbour (near Saint Petersburg) on the ecosystem of the Gulf of Finland (by phone).
12. 1 October 2015, A longer comment by T.Soomere to the news broadcast Reporter of TV channel Kanal 2 on the possible closure of the popular science journal Horisont.

13. 25 September 2015, A short comment of T.Soomere about possible closure of the major popular science journal Horisont to the main news program Aktuaalne Kaamera of the Estonian national TV channel ETV.
14. 12 September 2015, Karl Kello. The responsibility of science and scientists, based on the interview with T.Soomere. Õpetajate Leht (Teachers' Weekly),
15. 22 July 2015, The journal Energija un Pasaule published a longer interview (in Latvian) about studies into wave energy potential. The interview was largely based on material reflected in the paper [Soomere T., Eelsalu M., 2014. On the wave energy potential along the eastern Baltic Sea coast, *Renewable Energy* 71, 221–233] (*Energija un Pasaule*, 4(93), August–September 2015, 68–71).
16. 9 July 2015, The portal Novaator published an overview by M.Himma Scientists of the Tallinn University of Technology solved the puzzle of long-living water surface depressions in Venice Lagoon, that reflects the key message of the papers [Parnell K.E., Soomere T., Zaggia L., Rodin A., Lorenzetti G., Rapaglia J., Scarpa G.M. 2015. Ship-induced solitary Riemann waves of depression in Venice Lagoon. *Physics Letters A*, 379(6), 555–559] and [Rodin A., Soomere T., Parnell K.E., Zaggia L. 2015. Numerical simulation of the propagation of ship-induced Riemann waves of depression into Venice Lagoon. *Proceedings of the Estonian Academy of Sciences*, 64 (1), 22–35].
17. 9 July 2015, The portal Novaator published an overview by M.Himma: Estonian scientists identified a change in air flow as a possible reason for the decrease in the Baltic Sea salinity, that reflects the key message of the paper [Soomere T., Bishop S.R., Viška M., Räämet A. 2015. An abrupt change in winds that may radically affect the coasts and deep sections of the Baltic Sea. *Climate Research*, 62, 163–171].
18. 27 March 2015, T.Soomere, Academy reshapes the principles of selection of research professors, *Teachers' Weekly*, 511, 27.03.2015, 9 (in Estonian).
19. 26 March 2015, Dalia Bikauskaitė, based on an interview with T.Soomere and L.Kelpšaitė, *Vakaru Ekspresas* 2015-03-26, 12:01 (in Lithuanian).
20. 9 March 2015, A comment by T.Soomere about exhibition Applied hydrodynamics in Estonian Maritime Museum, to the broadcast Osoon of the national TV channel (in Estonian).
21. 4 March 2015, V.Rauniste, Riding high waves: marine scientist T.Soomere, *Meie Maa* (newspaper of Saaremaa County), 50(5563), 4.03.2015, 5 (in Estonian).
22. 4 March 2015, T.Soomere, Shores react within days or weeks to changing wave conditions, *Meie Maa* (newspaper of Saaremaa County), 50(5563), 4.03.2015, 5 (in Estonian).
23. 19 February 2015, A short interview with T.Soomere on the occasion of publication of the collection of popular science *Lehed ja Tähed* 7, Kuku Raadio, broadcast series *Loodusajakiri*.
24. 14 February 2015, Arko Olesk, Science prizes go to sparkling results, interview with T.Soomere on the occasion of 25th nomination of national science prizes, *Postimees – Arvamus*. *Kultuur*, 37(7331), 14.02.2015, 6-7 (in Estonian).
25. 1 February 2015, A longer interview with T.Soomere to the broadcast *Labor* of the national radio channel *Vikerraadio* about future plans of the Estonian Academy of Sciences and about perspectives of reshaping the landscape of science in Estonia (in Estonian).

26. 10 January 2015, A longer interview with T.Soomere to the broadcast Meretund (Marine Hour) of the radio channel Kuku Raadio about lessons from the exceptional storm and flooding in January 2005 (in Estonian).
27. 10 January 2014, H.Kuusk, The Nature is saving the Baltic Sea: the largest oxygen-rich salty water inflow over last half century, largely based on comments of T.Soomere, LP/Eesti Päevaleht 2(117), p. 7 (in Estonian).
28. 3 January 2015, A comment of T.Soomere to the major news program Aktuaalne Kaamera of the national TV channel about properties of the storm that occurred on the weekend (in Estonian and in Russian).
29. 3 January 2015, A comment by phone live on air of T.Soomere to the national radio channel Vikerraadio about changes in properties of the storm that occurred on the weekend compared to the earlier forecasts (in Estonian).
30. 2 January 2015, E.-M.Kukemelk, Marine scientist: the storm will be strong – problems with power supply expected, large trees may broke and roofs may be damaged, based on comments of T.Soomere, Delfi (online), 02.01.2015, 15:22 (in Estonian).
31. 2 January 2015, M.Männi, Laineekspert Soomere: Wave expert Soomere: storms are becoming more frequent, Postimees Online, 02.01.2015, 13:24 (in Estonian).

7. Summary

The year 2015 was the final year for the CENS within the Estonian Programme for Centres of Excellence in research (2011–2015). Beside ongoing research, the CENS has recently paid a lot of attention to summarizing the results over five years of activities. The summaries were presented in the following publications:

- “Keeruka maailma võlu” (Charm of Complex World), Tallinn, CENS, 2015, 111 pp. This is a science-popular explanation of activities in CENS over the recent years. The text was edited by an experienced science writer Tiit Kändler (the best European Science Writer in 2012) who has enlarged the presentation with exciting chapters from the history of science.
- “CENS Highlights 2011–2015”, Tallinn, CENS, 2015, 46 pp. This is a scientific overview on main research results with the references and analysis.
- “Proceedings of the Estonian Academy of Sciences”, 2015, vol. 64, Nos 3 and 3S. In these two issues a collection of papers from the IUTAM Symposium on Complexity of Nonlinear Waves (8-12 Sept, 2014) is presented including 12 papers from CENS fellows.

The most important scientific event in 2015 was the CENS Final Conference on 14 Sept, 2015 with the IAB members taking part. The full day was concluded with the discussion with the IAB who formulated their summary Opinion on the CENS (see Annex). The main conclusion of the IAB was that the CENS successfully completed its work. The detailed recommendations from the IAB are extremely useful for the future research. CENS would like once again to thank all the members of the IAB for their advices. A special letter to recognize their work was sent to all the members of the IAB. In the beginning of January 2016, the CENS submitted the official final report on its activities to the funding Agency “Archimedes” in order to conclude the Programme. The planned budget allotted to CENS by this Agency over 2011–2015 as a Centre of Excellence was 2,873,489 Euros and the CENS has used 2,871,415 Euros (99.93%). This formed a considerable part of the general budget of the CENS composed by various sources (see Part 4 of the Report). This official report was formulated in Estonian (such were the rules) but the “CENS Highlights 2011–2015) is available as a hard copy and also electronically (<http://cens.ioc.ee>) together with the summary of all activities.

The infrastructure of the CENS was considerably improved and the fluctuations of the budget for salaries (due the general restructuring of the research funding system in Estonia) balanced. The number of all the papers published over this period was 565 (indexed by WoS – 309). Altogether 24 young researchers earned their PhDs during this period. The international cooperation is going on with more than 30 centres over the world. The impact of the CENS on society is high thanks to activities of its leading fellows. T.Soomere has been especially active with his numerous talks and articles about the importance of marine sciences and general science policy.

However, from 2016 on, despite of excellent research results, we face the cuts in the next year budget (caused by the small State research budget and nonsustainable funding system introduced by the Estonian RC) and consequently also in the number of staff. Based on the recommendations of the IAB, the research will be more focused to areas where the best results up to now have been obtained (waves in solids, wave engineering and turbulence, cell energetics and optics) – all under the umbrella of complexity science.

This Annual Report 2015 is the last one in the series from 1999 until 2015. From 2016 on, the laboratories and research groups will all continue in the Institute of Cybernetics at Tallinn UT and the Institute of Physics of UT but the **Centre as such will be closed**. There are plans to reorganize the CENS into a virtual International Centre but this will take time and needs new leaders.

We would like to thank all our co-authors and colleagues for excellent cooperation on exciting problems.

Annex

1. The opinion of the IAB on activities of CENS
2. Information about Euromech Colloquium 582 in 2016
3. Abstracts
4. The staff

Annex 1: IAB Opinion on CENS Activities

Based on the IAB meeting and the CENS conference on 13–14 September 2015 (Tallinn), the IAB concluded (summary from various opinions of IAB members):

Preliminaries:

In order to survive in a harsh international competition and, if possible, renew its objective and expand in a controlled manner, a scientific research structure of excellence such as the CENS must apply certain working rules and comply with some obligations. Among these we emphasize:

- Some rules dictated by the relative smallness of the structure in a small country must be obeyed. These include a focus on a selection of subject matters that will together contribute to a clear vision of a rather precise scientific field. The latter may have grown along different branches but still keeping a common kernel with a marked originality that is clearly identified by external observers. Diversification and introduction of new subjects of interest must be achieved appropriately but with some control.
- An intense network of co-operations with other institutions in various countries is needed so as to avoid any risk of isolation and to favour creative innovations.
- A renewal of leadership is needed. This requires an active formation policy, locally and through exchanges with foreign institutions, as well as with a sufficient flux of newly formed young researchers, including through research stays abroad and long stays of foreign scientists at Tallinn.
- An active international policy of scientific publications eventually complemented by an efficient information of the accomplishments of the CENS to local authorities and the tax payers.

Since its creation the CENS has worked and developed along these lines and successfully followed such obligations.

General evaluation:

In spite of its apparent diversity, the Centre has succeeded to keep cohesion and a solid research line that is easily captured by outsiders and is illustrated by a series of well chosen keywords and the very names of the five units that comprise the Centre. Nonlinearity and complexity certainly are the two words that best encapsulate all of its activity. The notions of dynamics and processes are also well adapted to characterize this activity. As for what concerns more especially precise fields of research, the CENS remains marked by its origin, where waves, informatics and engineering were the main contributing elements.

The Centre for Nonlinear Studies successfully completed its work in 2015. All contributing research groups obtained first class results of fundamental importance as well as practical impact. Some groups are among the scientific leaders internationally in the field of nonlinear systems. In their essential parts, the studied topics address the structure and dynamics of nonlinear dynamic processes in natural and artificial systems. The universality of the mathematical laws in the relevant mechanisms was clearly demonstrated. In particular, the results cover nonlinear wave phenomena in structured solids, ocean scenarios, complex biological molecular structures, and structured broadband optical waves and wave-packets. Furthermore, basic mathematical investigations in control theory were presented. The analytical and numerical mathematical tools represent a high standard. Selected topics like ocean dynamics in the Baltic Sea, heart medical studies or glass photoelasticity, to give only a few examples, are obviously of significant potential economic impact. On a fundamental level, the intriguing analogies between many kinds of wave and complexity effects might be of general interest. They open not only perspectives for novel engineering solutions but insight into the working principles of nature as well.

In some way we should apply the theory of complex systems to the Centre itself. The Centre produces an outcome that is greater than the sum of the parts - the parts here being the individual researchers who could act on their own but see the benefit of mutual activities and promote the sharing of best practice.

Specific remarks on some fields of research

Wave Engineering: the focus is on water waves in shallow water impacting on the coast. By using data specific to Estonian coast and the Baltic Sea, this group has developed seminal concepts about modelling wave impacts on beaches. Significantly it has benefited from close international collaborations. It is a high priority that this area be enabled to continue and grow further as a world-leading research group.

System Biology: the group is studying the regulation of intracellular processes and understanding the influence of intracellular interaction. Research is based on experimental analysis, (bio)physical modelling and computational analysis. Two more recent highlights are here briefly mentioned: (i) kinetic measurements on the role of the enzyme $Na^+ / K^+ - ATPase$; (ii) the mechanism of the diffusion restriction at the mitochondrial outer membrane level. Results are published in high-impact journals and the Head of the Laboratory was able to carry in about 1 Meuro grant from the Wellcome Trust (2007–2014).

Nonlinear Dynamics: the studies on nonlinear waves in solids with the focus on the effect of microstructure are internationally competitive and seminal complemented by original viewpoints on some thermodynamic approach and development in modern techniques of acousto-diagnostics. It is worth mentioning the research in the Laboratory of Photoelasticity with the spin-off company GlasStress AP, running also Summer Schools in Tallinn, UK and the US.

Nonlinear Control Theory: the research is at the forefront of international research and combines important new developments on nonlinear control theory with software implementation that allows an application of those results – a rare, noteworthy and admirable combination.

Optics: The group performed fundamental research at the very front of ultrashort-pulse wave optics. As it was demonstrated by the group, the formation and transfer of images by truncated Bessel-like beams can be realized. Another important topic of practical relevance was the temporal focusing of ultra-broadband light which can be applied to explore processes in nature with unprecedented temporal resolution. Remarkable results with respect to laterally non-dispersing Airy bullets open new prospects for sophisticated applications in photonics and optoelectronics which require curvilinear propagation characteristics.

Teaching and popularization

The distribution of PhD students does not have to be uniform in the units, but the change in the interest of the young research generation may lead to required changes in the structure of the centre, too. With appropriate tenure-track system, the next generation of applicants can be steered at a certain level, but the human resources of the centre could also be varied accordingly in the future.

The gained knowledge is also connected with teaching so that students and young scientists achieve the latest output from this Centre. Very impressive is also the successful effort to communicate research results to the society by means of, e.g., a book (in Estonian language) with the title “Keeruka maailma võlu” compiled by the Estonian science writer Tiit Kändler. It is an educational book which explains scientific findings of CENS in a language written for the public – even equations are illustrated for understanding by high school pupils. This is an example which should be followed by other groups and other countries.

In different levels, both the units alone and the whole centre together made serious and successful efforts to make their scientific results not just for the international research community, but also for the non-expert decision makers and tax-payers of their country. Some traditional work like the preparation of students for Physics Olympiads had always been there in the work of the

centre, but the last 5 years show a significant improvement in popularization.

General recommendations:

It is recommended continuing the activities of the Centre. Studies in nonlinear wave propagation, which is a central element in many applications, and also studies in systems biology need surely be supported. In future work, particular emphasis should be laid on strongly focusing on a rather limited number of research topics of highest excellence on the basis of previous results. It might be that some consideration could be given to forming several groups along the topics of Nonlinear Dynamics.

Among the new noticeable strengths we note the proposal of moving fractal sets and associated scaling laws, the explicit presentation of a general mechanism of single-cell bioenergetics, the method of integrated nonlinear photo-elastic tomography, and the all round approach to waves at sea, wave climatology, pollution, and coastal protection. Many of these subjects are not only truly scientific but they also strongly contribute to socio-economical pre-occupations. The field of optics further extends to measuring techniques, plasmons on surfaces and other areas of interest where one has to expect strong synergetic effects and the design of technical devices. In particular CENS has a unique selling point in that engineers and applied mathematicians are brought together with a wide view on the field ranging from important research in control theory to more applied topics around sea waves. The Centre can (beside research) provide an environment for informal exchange of ideas and concepts which are beneficial but often not actually realized in actual publication-producing collaborations.

Proposal:

The emphasized change in the concept of “excellence centre” should necessarily pose questions that need serious pondering. One that may sound marginal is the possible change of name of the Institute. Although historical, the “cybernetics” in its title still puzzles many external observers. It would be better to give it a name such as the “Alumäe Institute of Nonlinear and Complex Sciences” that will be more exact from the scientific viewpoint while earn marking the “Estonian” nature with the name of an eminent Estonian scientist. This may trigger some new developments.

International Advisory Board

Prof. F.Allgöwer (Stuttgart), Prof. S.Bishop (London), Prof. R.Grimshaw (Loughborough), Dr. R.Grunwald (Berlin), Prof. G.Holzapfel (Graz), Prof. G.A.Maugin (Paris), Prof. F.Pastrone (Turin), Prof. G.Stepan (Budapest).

Annex 2: Euromech Colloquium 582

EUROPEAN
MECHANICS
SOCIETY

Euromech Colloquium 582
"Short Fibre Reinforced
Cementitious Composites and Ceramics"
20.-23. June 2016, Tallinn, Estonia



<http://582.euromech.org> email: ec582@ioc.ee

Venue: Innovation center "Mektory" at Tallinn University of Technology

The colloquium will focus on Short Fibre Reinforced Cementitious Composites (SFRCC) and metal particle reinforced ceramics. SFRCC are gaining rapidly more importance in civil engineering, most prominently Steel Fibre Reinforced Concrete (SFRC). This is despite the fact, that construction codes are still under development, and that the material is still subject to research. These composites share some mechanical properties with ceramics, despite the different chemistry and length scales.

One of the aims of this colloquium is to bring together civil engineers, material scientists and researchers from micro-mechanics to discuss and possibly develop cooperations. Contributions are welcome and expected from experimental, numerical and theoretical view points.

Topics (non-exhaustive list):

- measurement of fibre orientations
- characterization of micro-structure
- constitutive modeling
- fracture and cracking behaviour
- numerical modeling
- experiments

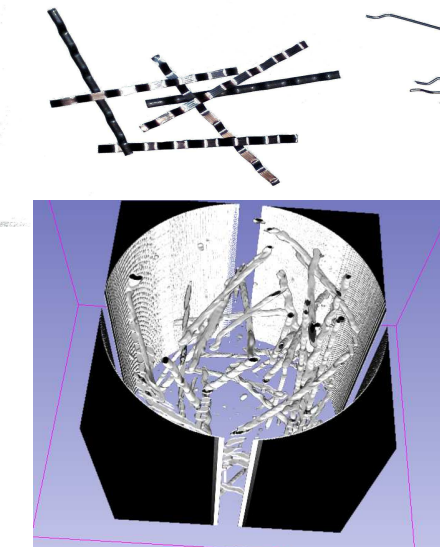
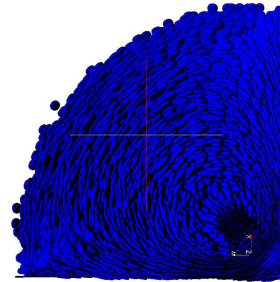

Chairpersons

Dr. Heiko Herrmann
Institute of Cybernetics at
Tallinn University of Technology
Akadeemia tee 21
12618 Tallinn
Estonia
Phone: + 372 6204228
e-mail: ec582@ioc.ee

Prof. Dr.-Ing. Jürgen Schnell
Technische Universität Kaiserslautern
Fachbereich Bauingenieurwesen
Fachgebiet Massivbau und Baukonstruktion
67663 Kaiserslautern, Germany

Annex 3: Abstracts

1. T.Peets, K.Tamm, J.Engelbrecht. Mechanical waves in biomembranes. In: The 9th Int. Conf. On Nonlinear Evolution Equations and Wave Phenomena: Computation and Theory. Univ of Georgia, Athens GA, USA, April 1-4, 2015, pp 29-30.
2. J.Engelbrecht, A.Berezovski, P.Van, A.Szekeres. Wave dynamics and complexity: results of the Hungarian-Estonian joint research. XII Hungarian Mechanics Conference 2015, Miskolc, p 22.
3. J.Engelbrecht, A.Berezovski. Modelling of wave interactions in microstructured materials. ESMC 2015, Madrid-Leganés, CD-ROM.
4. T.Peets, K.Tamm, J.Engelbrecht. Numerical investigation of mechanical waves in biomembranes. 3rd ECCOMAS Young Investigators Conf., July 20-23, 2015, Aachen.
5. K.Tamm, T.Peets, D.Kartofelev. Boussinesq paradigm and negative group velocity in a material with double microstructure. The Ninth IMACS Intern. Conf. Nonlinear Evolution Equations and Wave Phenomena: Computation and Theory, Athens, Georgia, Book of Abstracts, April 1-4, 2015. (Ed.): Biondini, Gino; Taha, Thiab. Athens, Georgia: University of Georgia.
6. T.Peets, K.Tamm, A.Salupere. Double microstructured material model with negative group velocity. (Eds.) J.Plešek, D.Gabriel, R.Kolman, J.Masák, Inst. of Thermomechanics, Prague, Czech Republic, Jan. 26 Nov., 2015.
7. A.Berezovski. Thermoelastic waves in microstructured solids. Int. Conf. Continuous Media with Microstructure, CMwM2015, Łagów 2-5 March 2015, Book of Abstracts, pp. 31-32.
8. A.Salupere, M.Ratas. On solitonic structures and discrete spectral analysis. In: Book of Abstracts : The Ninth IMACS Int. Conf. Nonlinear Evolution Equations and Wave Phenomena: Computation and Theory, Athens, Georgia, April 1-4, 2015: (Eds.) Biondini, Gino; Taha, Thiab. Athens, Georgia: University of Georgia, 30.
9. A.Valdmann, P.Piksarv, H.Valtna-Lukner, P.Saari. White-light hyperbolic Airy beams. Ultrafast Optics (UFO X), Beijing, China, August 16-21, 2015.
10. A.Valdmann, P.Piksarv, H.Valtna-Lukner. Propagation speed and transformation of light into Bessel and Airy pulsed fields in optical elements, as measured with single-cycle temporal resolution. Northern Optics & Photonics 2015, Lappeenranta, Finland, June 2-4, 2015, 6.
11. P.Piksarv, D.Marti, Tuan Le, A.Unterhuber, A.Stingl, W.Drexler, P.E.Andersen, K.Dholakia. Compact Two-Photon Fluorescence Light-Sheet Microscopy using Airy Beam Illumination. 2nd Light Sheet Fluorescence Microscopy Int. Conf., Genoa, July 5-8 2015, 36.
12. O.Didenkulov, I.Didenkulova, E.Pelinovsky. A note on the uncertainty in tsunami shape for estimation of its run-up heights. Geophysical Research Abstracts, 17, EGU2015-1240.
13. I.Didenkulova, E.Pelinovsky, O.Didenkulov, A.Rodin. Run-up of long solitary waves of different polarities on a plane beach. Geophysical Research Abstracts, 17, EGU2015-1241.
14. O.Didenkulov, I.Didenkulova, E.Pelinovsky. Transformation and run-up of single and periodic waves in the bay of parabolic cross-section. Geophysical Research Abstracts, 17, EGU2015-1384.

15. J.M.Muñoz, A.O.Arias, C.Winter, I.Didenkulova, L.Otero. Analysis of infragravity waves using Complete Ensemble Empirical Mode Decomposition (CEEMD) on microtidal and macrotidal beaches. *Geophysical Research Abstracts*, 17, EGU2015-3997.
16. T.Soomere. Challenges of climatic changes for coastal engineering. *Proc. XII Finnish Mechanics Days*. Kouhia R., Mäkinen J., Pajunen S., Saksala T., (Eds.). Finnish Association for Structural Mechanics, Helsinki, 17.
17. T.Soomere. Societal challenges in marine science. In: 10th Baltic Sea Science Congress "Science and innovation for future of the Baltic and the European regional seas" 15–19 June 2015, Riga, Latvia. Abstract book, 15.
18. N.Delpeche-Ellmann, T.Torsvik. Examination of the effects of wind induced forcings on surface drifters circulation patterns in the Gulf of Finland. *Ibid.*, 48.
19. T.Torsvik, I.Didenkulova, V.V.S.S.R.Hemanth. Measurements of wave transformation in the coastal zone. *Ibid.*, 53.
20. A.Lehmann, I.Didenkulova, K.Höfllich. A simple approach to determine the Stokes drift for the entire Baltic Sea. *Ibid.*, 57.
21. K.Pindsoo, T.Soomere. Trends in extreme water levels of the eastern Baltic Sea. *Ibid.*, 76.
22. T.Soomere, M.Eelsalu. Separation of the Baltic Sea water level into short-term and multi-weekly components. *Ibid.*, 84.
23. M.Eelsalu, T.Soomere, K.Pindsoo, P.Lagemaa. Ensemble approach for the projections of extreme water levels reveals bias in water level observations. *Ibid.*, 85.
24. K.Pindsoo, T.Soomere. Contribution of wave set-up into the total water level in the Tallinn area. *Ibid.*, 87.
25. O.Kovaleva, B.Chubarenko, D.Ryabchuk. Analysis of sediment transport pattern along the coastal line of the Russian part of the Curonian Spit. *Ibid.*, 92.
26. J.Harff, J.Deng, J.Dudzinska-Nowak, A.Groh, B-Hünicke, M.Viška, W.Zhang. Why is the Baltic Sea special in coastal morphodynamics? – A comparative study. *Ibid.*, 107.
27. B.Viikmäe, T.Soomere, T.Torsvik. Quantification of the impact of wind for optimising fairways in the Gulf of Finland. *Ibid.*, 151.
28. T.Torsvik, B.Viikmäe. Investigation of surface currents near Cape Kolka in the Gulf of Riga by use of surface drifters. *Ibid.*, 153.
29. D.Pupienis, I.Buynevich, D.Jarmalavicius, Žilinskas, J.Fedorovic, D.Ryabchuk, O.Kovaleva, A.Sergeev. Spatial pattern in heavy-mineral concentrations on the Curonian Spit sea coast as indicator of human activities and natural processes. *Ibid.*, 159.
30. L.Davulienė, L.Kelpšaitė, T.Torsvik, I.Dailidienė. A study of the sea surface boundary layer dynamics. *Ibid.*, 165.
31. M.Eelsalu, T.Soomere, K.Julge, E.Grünthal. Quantification of the changes in sediment volume in a small beach applying laser scanning technology. *Ibid.*, 197.
32. K.Pindsoo, T.Soomere, M.Eelsalu, H.Tõnisson. Quantification of the impact of vessel wakes on a shingle-gravel beach. *Ibid.*, 201.

33. A.Rodin, I.Didenkulova, E.Pelinovsky. The transformation and run-up of long breaking solitary waves of various polarities on a sloping beach. *Ibid.*, 204.
34. K.E.Parnell, T.Soomere, L.Zaggia, A.Rodin. Numerical study of propagation of ship-induced wave troughs in Venice Lagoon. *Ibid.*, 207.
35. O.Kovaleva, T.Soomere, M.Eelsalu. Comparison of the wave power for the open and sheltered segments of the Baltic Sea coast. *Ibid.*, 210.
36. O.Kovaleva, T.Soomere, M.Eelsalu, D.Ryabchuk. Determination of closure depths for sheltered areas of the eastern part of the Baltic Sea. *Ibid.*, 233.
37. T.Mingëlaitė M.Eelsalu, K.Pindsoo, T.Soomere, I.Dailidienė. Return periods of extreme water levels along Lithuanian sea coast based on a simple ensemble of projections. *Ibid.*, 238.
38. A.Giudici. Measurement of spontaneous current-induced patch formation processes in the marine surface layer. *Ibid.*, 246.
39. I.Artemchuk, Ü.Nurges, J.Belikov, V.Kaparin. Stable cones of polynomials via Routh rays. In: *Summaries Volume. 20th Int. Conf. Process Control 2015, June 9-12, Strbské Pleso, Slovak Republic*, 33.
40. M.Ciulkin, E.Pawluszewicz, V.Kaparin, Ü.Kotta. Input-output linearization by dynamic output feedback on homogeneous time scales. In: *MMAR 2015: 20th Intern. Conf. Methods and Models in Automation & Robotics, 24-27 August 2015, Miedzyzdroje, Poland, Abstracts: Szczecin: West Pomeranian Univ. Techn.*, 53.
41. M.Eelsalu, T.Soomere, K.Julge. Quantification of changes in the beach volume by applying an inverse Bruun's Rule and laser scanning technology in Pirita Beach, Tallinn Bay. In: *Climate modelling and impacts from the global to the regional to the urban scale. Int. sci. seminar at HafenCity University Hamburg, 10 March 2015, Poster Abstracts: Baltic Earth; HCU*, 8.
42. M.Eik, J.Puttonen. Teraskiudbetooni teadusuuringud rakendustesse. Ettekanne ehitusinseneridele, Nordecon AS ehituskontserni peamajas, Tallinn, Eesti. 18 Veebruar 2015.
43. A.Giudici, T.Soomere. Identification of areas of spontaneous current-induced surface patch formation in the Gulf of Finland. In: *Climate modelling and impacts from the global to the regional to the urban scale. Int. sci. seminar at HafenCity University Hamburg, 10 March 2015, Poster Abstracts: Baltic Earth; HCU*, 9.
44. H.Herrmann. A comparison of constitutive models for short fibre reinforced brittle materials. In: *EUROMECH Colloquium 577: Micromechanics of Metal Ceramic Composites, March 2-5, 2015, Stuttgart, Germany*, 22.
45. A.Kaldmäe, C.H.Moog, C.Califano. Towards integrability for nonlinear time-delay systems. In: *MICNON 2015: The 1st IFAC Conf. Modelling, Identification and Control of Nonlinear Systems, June 24-26, 2015, Saint Petersburg, Russia, Book of Abstracts: Saint Petersburg: ITMO University*, 50.
46. K.Pindsoo, T.Soomere. Contribution of wave induced set-up into total water level in the urban area of Tallinn. In: *Climate modelling and impacts from the global to the regional to the urban scale: Int. sci. seminar at HafenCity University Hamburg, 10 March 2015, Poster Abstracts: Baltic Earth; HCU*, 15.

47. A.Stulov. Piano hammer-string contact duration: How the bass hammer is released from the string. In: Bridging the Gaps: 3rd Vienna Talk on Music Acoustics, Mi, 16.bis Sa, 19 September 2015, Abstract Book, Vienna, University of Music and Performing Arts Vienna, 43.
48. A.Stulov, V.I.Erofeev. Frequency-dependent attenuation and phase velocities dispersion of an acoustical wave propagation in the media with damages. In: Generalized Continua as Models for Materials with Multi-Scale-Effects or under Multi-Field-Actions, September 21-25, 2015, Experimental Factory, Magdeburg, Germany, Book of Abstracts: (Eds.) H.Altenbach, S.Holm, 41.

Annex 4: The staff of research teams in CENS in 2015:

Head of CENS: Jüri Engelbrecht, DSc.

Nonlinear dynamics

Head of team: Jaan Kalda, PhD.

Leading scientist: Hillar Aben, DSc, Jüri Engelbrecht, DSc.

Senior researchers: Johan Anton, PhD; Arkadi Berezovski, PhD; Heiko Herrmann, PhD; Jaan Kalda, PhD; Andrus Salupere, PhD; Anatoli Stulov, PhD.

Researchers: Marika Eik, PhD; Dmitry Kartofelev, PhD; Robert Kitt, PhD; Tanel Peets, PhD; Kert Tamm PhD; Anna Šeletski, PhD; Andrus Braunbrück, PhD; Mihkel Kree, MSc.

PhD students: Siim Ainsaar, Mihkel Heidelberg, Jakob Jõgi, Martin Lints, Indrek Mandre, Emiliano Pastorelli, Stephanie Rendon, Ivan Sertakov.

Other: Mati Kutser, PhD, Kristi Uustalu, MSc, Tatjana Kosmatšova, Marella Õis.

Wave engineering

Head of team: Tarmo Soomere, DMath.

Senior researchers: Tomas Torsvik, PhD.

Researchers: Nicole Delpêche-Ellmann, PhD; Ewald Quack, PhD; Irina Nikolkina, PhD; Andrus Räämet, PhD; Bert Viikmäe, PhD; Maija Viška, PhD; Irina Didenkulova, PhD, Andrea Giudici, PhD; Artem Rodin, PhD.

PhD students: Maris Eelsalu, Olga Kovaleva, Katri Pindsoo, Rain Männikus, Nadezda Kudrjavitseva, Toma Mingelaite.

Other: Marika Org, Peeter Keres, Ebe Pilt, Anda Zule-Lapimaa, Marius Žalys.

Systems biology

Head of team: Marko Vendelin, PhD.

Senior researchers: Rikke Birkedal Nielsen, PhD; Pearu Peterson, PhD.

Researchers: Mari Kalda, PhD; Niina Karro, PhD.

PhD students: Jelena Branovets, Natalja Jephikhina, Svetlana Jugai, Martin Laasmaa, Päivo Simson.

Optics

Head of team: Peeter Saari, DSc.

Researchers: Heli Valtna-Lukner, PhD; Peeter Piksarv, PhD.

PhD students: Andreas Valdmann.

Other: Agu Anijalg.

Nonlinear control theory

Head of team: Ülle Kotta, DSc.

Senior researchers: Ülo Nurges, PhD; Maris Tõnso, PhD; Jüri Vain, PhD; Tanel Mullari, PhD.

Researchers: Jüri Belikov, PhD; Vadim Kaparin, PhD.

PhD students: Arvo Kaldmäe.

PhD students in TUT: Aivo Anier, Sergei Avanesov, Jaagup Irve.

As a rule PhD students have part-time positions.

CENS

Institute of Cybernetics at TUT

Akadeemia tee 21

Tallinn 12618, Estonia

Phone: (+372) 620 4150

Fax: (+372) 620 4151

Prof. J. Engelbrecht, je@ioc.ee

Prof. H. Aben, aben@ioc.ee

Prof. T. Soomere, soomere@cs.ioc.ee

Prof. J. Kalda, kalda@cs.ioc.ee

Dr. M. Vendelin, markov@sysbio.ioc.ee

Dr. Ü. Kotta, kotta@ioc.ee

Prof. P. Saari, peeter.saari@ut.ee

Internet: <http://cens.ioc.ee>