



EESTI VABARIIK

**T** **EESTI**  
**TÖÖSTUSDISAINI-**  
**LAHENDUSE LEHT**



PATENDIAMETI AMETLIK VÄLJAANNE

**3**  
**2009**  
TALLINN



ISSN 1406-376X

EESTI VABARIIK

**T** **EESTI**  
**TÖÖSTUSDISAINI-**  
**LAHENDUSE LEHT**

**PATENDIAMETI  
AMETLIK VÄLJAANNE**

**XII aastakäik**

**Käesolevas numbris  
esitatud andmed  
loetakse avaldatuks  
17. augustil 2009. a.**

**3**  
**2009**  
**AUGUST  
TALLINN**

Eesti Tööstusdisainilahenduse Lehte antakse välja tööstusdisaini kaitse seaduse (jõustunud 11.01.1998) alusel.  
The Estonian Industrial Design Gazette is the official publication of the Estonian Patent Office.  
Published under Industrial Design Protection Law of the Republic of Estonia (coming into force 11 January 1998).  
Date of publication of the data presented in this issue - 17 August 2009.

Patendiameti  
infoosakond  
Toompuiestee 7  
15041 Tallinn  
Tel 627 7907  
Faks 627 7943  
E-post Info@epa.ee

The Information Department  
of the Estonian Patent Office  
Toompuiestee 7  
15041 Tallinn, ESTONIA  
Phone +372 627 7907  
Fax +372 627 7943  
E-mail Info@epa.ee

Levitaja

Eesti Patendiraamatukogu  
Olevimägi 8/10  
10123 Tallinn  
Tel 641 1248  
Faks 641 1018  
E-post patent@patentlib.ee

Distributor

Estonian Patent Library  
Olevimägi 8/10  
10123 Tallinn, ESTONIA  
Phone +372 641 1248  
Fax +372 641 1018  
E-mail patent@patentlib.ee

## SISUKORD

Andmete identifitseerimise rahvusvahelised numberkoodid (INID-koodid) . . . . .	4
Riikide, teiste ühenduste ja valitsustevaheliste organisatsioonide koodid . . . . .	5
I. REGISTREERITUD TÖÖSTUSDISAINILAHENDUSED . . . . .	6
II. RAHVUSVAHELISELT REGISTREERITUD TÖÖSTUSDISAINILAHENDUSED . . . . .	27
III. MUUD REGISTRIKANDID . . . . .	45
Registreeringu kehtivuse pikendamine . . . . .	45
Tööstusdisainilahenduse üleminek . . . . .	-
Registreeringu jagamine . . . . .	-
Registreeringu andmete muudatused . . . . .	45
Registreeringu andmete parandused . . . . .	-
Tööstusdisainilahenduse litsentsimine . . . . .	-
Tööstusdisainilahenduse pantimine . . . . .	-
Tööstusdisainilahenduse tunnistuse duplikaadi väljaandmine . . . . .	-
Registreeringu kustutamine . . . . .	45
IV. LOENDID . . . . .	46
Registreeritud tööstusdisainilahenduste registreerimise taotluste numbriline loend . . . . .	46
Rahvusvaheliselt registreeritud tööstusdisainilahenduste numbriline loend . . . . .	46
V. TÖÖSTUSDISAINIALASED ÕIGUSAKTID JA MUU INFO . . . . .	47
Riiklikus patendivolinike registris registreeritud patendivolinike nimekiri . . . . .	47

## CONTENTS

Internationally Agreed Numbers for the Identification of Data (INID Codes) . . . . .	4
List of Codes of States, Other Entities and Intergovernmental Organizations . . . . .	5
I. REGISTERED INDUSTRIAL DESIGNS . . . . .	6
II. INTERNATIONALLY REGISTERED INDUSTRIAL DESIGNS . . . . .	27
III. OTHER ENTRIES IN THE REGISTER . . . . .	45
Extension of the Registration . . . . .	45
Transfer of Industrial Design . . . . .	-
Division of the Registration. . . . .	-
Amendments to Registration Data . . . . .	45
Corrections to Registration Data . . . . .	-
Licensing of Industrial Design . . . . .	-
Pledging of Industrial Design . . . . .	-
Issue of a Copy of the Industrial Design Certificate . . . . .	-
Deletion of the Registration . . . . .	45
IV. LISTS . . . . .	46
Numerical List of Registration Applications of Registered Industrial Designs . . . . .	46
Numerical List of Internationally Registered Industrial Designs . . . . .	46
V. LEGAL ACTS AND INFORMATION CONCERNING INDUSTRIAL DESIGNS . . . . .	47
List of Patent Attorneys, Registered in the Estonian State Register of Patent Attorneys . . . . .	51

**ANDMETE IDENTIFITSEERIMISE  
RAHVUSVAHELISED NUMBERKOODID  
(INID-KOODID)  
WIPO Standard ST. 80**

**INTERNATIONALLY AGREED NUMBERS FOR  
THE IDENTIFICATION OF DATA  
(INID CODES)  
WIPO Standard ST. 80**

(11) Registreeringu number	(11) Number of the Registration
(15) Registreerimise kuupäev	(15) Date of the Registration
(18) Registreeringu kehtivuse lõppemise kuupäev	(18) Expected expiration date of the registration
(21) Registreerimistaotluse number	(21) Application Number
(22) Registreerimistaotluse esitamise kuupäev	(22) Application Filing Date
(24) Registreeringu kehtivuse alguse kuupäev	(24) Date from which the Industrial Design right has effected
(28) Variantide arv	(28) Number of Industrial Designs included in the application
(30) Prioriteet	(30) Priority
(51) Rahvusvahelise klassifikatsiooni klassi ja alaklassi number	(51) International Classification for Industrial Designs (class and subclass of the Locarno Classification)
(54) Tööstusdisainilahenduse nimetus	(54) Title of the Industrial Design
(55) Tööstusdisainilahenduse reproduktsioon	(55) Reproduction of the Industrial Design
(72) Tööstusdisainilahenduse autor(id)	(72) Author(s) of Industrial Design
(73) Tööstusdisainilahenduse omanik(ud)	(73) Proprietor(s) of Industrial Design
(74) Patendivolinik või ühine esindaja	(74) Patent Attorney or Common Representative

**RIIKIDE, TEISTE ÜHENDUSTE JA VALITSUSTEVAAHELISTE  
ORGANISATSIOONIDE KOODID**

AD	Andorra	DZ	Alžeeria	JM	Jamaica	PW	Belau
AE	Araabia	EA	Euraasia	JO	Jordania	PY	Paraguay
	Ühendemiraadid		Patendiorganisat-	JP	Jaapan	QA	Katar
AF	Afganistan		sioon (EAPO)	KE	Kenya	RO	Rumeenia
AG	Antigua ja Barbuda	EC	Ecuador	KG	Kõrgõzstan	RS	Serbia
AI	Anguilla	EE	Eesti	KH	Kambodža	RU	Venemaa
AL	Albaania	EG	Egiptus	KI	Kiribati	RW	Rwanda
AM	Armeenia	EH	Lääne-Sahara	KM	Komoorid	SA	Saudi Araabia
AN	Hollandi Antillid	EM	Siseturu	KN	Saint Kitts ja Nevis	SB	Saalomoni Saared
AO	Angola		Ühtlustamise	KP	Põhja-Korea	SC	Seišellid
AP	Aafrika Regionaalne		Amet (kaubamärgid	KR	Lõuna-Korea	SD	Sudaan
	Tööstusomandi Orga-		ja tööstusdisaini-	KW	Kuveit	SE	Rootsi
	nisatsioon (ARIPO)		lahendused) (OHIM)	KY	Kaimanisaared	SG	Singapur
AR	Argentina	EP	Euroopa	KZ	Kasahstan	SH	Saint Helena
AS	Ameerika Samoa		Patendiamet (EPO)	LA	Laos	SI	Sloveenia
AT	Austria	ER	Eritrea	LB	Liibanon	SK	Slovakkia
AU	Austraalia	ES	Hispaania	LC	Saint Lucia	SL	Sierra Leone
AW	Aruba	ET	Etiopia	LI	Liechtenstein	SM	San Marino
AZ	Aserbaidžaan	FI	Soome	LK	Sri Lanka	SN	Senegal
BA	Bosnia ja	FJ	Fidži	LR	Libeeria	SO	Somaalia
	Hertsegoviina	FK	Falklandi (Malviini)	LS	Lesotho	SR	Suriname
BB	Barbados		saared	LT	Leedu	ST	São Tomé ja Príncipe
BD	Bangladesh	FM	Mikroneesia	LU	Luksemburg	SV	El Salvador
BE	Belgia	FO	Fääri saared	LV	Läti	SY	Süüria
BF	Burkina Faso	FR	Prantsusmaa	LY	Liibüa	SZ	Svaasimaa
BG	Bulgaaria	GA	Gabon	MA	Maroko	TC	Turks ja Caicos
BH	Bahrein	GB	Ühendkuningriik	MC	Monaco	TD	Tšaad
BI	Burundi		(Suurbritannia)	MD	Moldova	TG	Togo
BJ	Benin	GC	Pärsia Lahe	ME	Montenegro	TH	Tai
BM	Bermuda		Koostööõnukogu	MG	Madagaskar	TJ	Tadžikistan
BN	Brunei	GD	Grenada	MH	Marshalli Saared	TM	Türkmenistan
BO	Boliivia	GE	Gruusia	MK	Makedoonia	TN	Tuneesia
BR	Brasiilia	GG	Guernsey	ML	Mali	TO	Tonga
BS	Bahama	GH	Ghana	MM	Myanmar (Birma)	TL	Ida-Timor
BT	Bhutan	GI	Gibraltar	MN	Mongoolia	TR	Türgi
BV	Bouvet' saar	GL	Gröönimaa	MO	Macao	TT	Trinidad ja Tobago
BW	Botswana	GM	Gambia	MP	Põhja-Mariaanid	TV	Tuvalu
BX	Beneluxi	GN	Guinea	MR	Mauritaania	TW	Taiwan (Hiina provints)
	Kaubamärgiamet	GQ	Ekvatoriaal-Guinea	MS	Montserrat	TZ	Tansaania
	(BBM) ja Beneluxi	GR	Kreeka	MT	Malta	UA	Ukraina
	Tööstusdisainilahen-	GS	Lõuna-Georgia ja	MU	Mauritius	UG	Uganda
	duste Amet (BBDM)		Lõuna-Sandwichi	MV	Maldiivid	US	Ameerika
BY	Valgevene		saared	MW	Malawi		Ühendriigid
BZ	Belize	GT	Guatemala	MX	Mehhiko	UY	Uruguay
CA	Kanada	GW	Guinea-Bissau	MY	Malaisia	UZ	Usbekistan
CF	Kesk-Aafrika	GY	Guyana	MZ	Mosambiik	VA	Vatikan (Püha Tool)
	Vabariik	HK	Hongkong	NA	Namiibia	VC	Saint Vincent ja
CG	Kongo	HN	Honduras	NE	Niger		Grenadiinid
CH	Šveits	HR	Horvaatia	NG	Nigeeria	VE	Venezuela
CI	Côte d'Ivoire	HT	Haiti	NI	Nicaragua	VG	Neitsisaared
CK	Cooki saared	HU	Ungari	NL	Holland	VN	Vietnam
CL	Tšiili	IB	Ülemaailmse	NO	Norra	VU	Vanuatu
CM	Kamerun		Intellektuaalomandi	NP	Nepal	WO	Ülemaailmne
CN	Hiina		Organisatsiooni	NR	Nauru		Intellektuaalomandi
CO	Kolumbia		(WIPO) Rahvus-	NZ	Uus-Meremaa		Organisatsioon
CR	Costa Rica		vaheline Büroo	OA	Aafrika Intellektuaal-		(WIPO) (Rahvus-
CU	Kuuba	ID	Indoneesia		omandi Organisat-		vaheline Büroo)
CV	Cabo Verde	IE	Iiri		sioon (OAPI)	WS	Samoa
CY	Küpros	IL	Iisrael	OM	Omaan	YE	Jeemen
CZ	Tšehhi	IM	Man'i saar	PA	Panama	ZA	Lõuna-Aafrika Vabariik
DE	Saksamaa	IN	India	PE	Peruu	ZM	Sambia
DJ	Djibouti	IQ	Iraak	PG	Paapua Uus-Guinea	ZR	Zaire
DK	Taani	IR	Iraan	PH	Filipiinid	ZW	Zimbabwe
DM	Dominica	IS	Island	PK	Pakistan		
DO	Dominikaani	IT	Itaalia	PL	Poola		
	Vabariik	JE	Jersey	PT	Portugal		

## **I. REGISTREERITUD TÖÖSTUSDISAINILAHENDUSED**

Avaldatakse "Tööstusdisaini kaitse seaduse" § 55<sup>1</sup> lõike 7 alusel.

Patendiamet ei ole kontrollinud tööstusdisainilahenduse uudsust ja eristatavust tulenevalt "Tööstusdisaini kaitse seaduse" § 31 lõike 2 punktist 1.

(11) Registreeringu number	<b>01521</b>	(51) Klass: <b>02-02</b>
(21) Taotluse number	D200900021	
(15) Registreerimise päev	17.08.2009	
(22) Esitamise päev	12.03.2009	
(24) Registreeringu kehtivuse alguse päev	12.03.2009	
(18) Registreeringu kehtivuse lõppemise päev	12.03.2014	
(28) Variantide arv	1	
(72) Autor	Mariliis Soobard, Metsa 25, Virtsu, Hanila vald, 90101 Lääne maakond, EE	
(73) Omanik	Mariliis Soobard, Metsa 25, Virtsu, Hanila vald, 90101 Lääne maakond, EE	

(54) Nimetus **Treeningurõivas**

(55) Reproduktsoon

01521-1





(11) Registreeringu number	<b>01522</b>	(51) Klass: <b>02-02</b>
(21) Taotluse number	D200900022	
(15) Registreerimise päev	17.08.2009	
(22) Esitamise päev	12.03.2009	
(24) Registreeringu kehtivuse alguse päev	12.03.2009	
(18) Registreeringu kehtivuse lõppemise päev	12.03.2014	
(28) Variantide arv	2	
(72) Autor	Mariliis Soobard, Metsa 25, Virtsu, Hanila vald, 90101 Lääne maakond, EE	
(73) Omanik	Mariliis Soobard, Metsa 25, Virtsu, Hanila vald, 90101 Lääne maakond, EE	

(54) Nimetus **Treeningurõivas**

(55) Reproduktsoon

01522-1



01522-2



- (11) **Registreeringu number** **01523**
- (21) **Taotluse number** D200900024
- (15) **Registreerimise päev** 17.08.2009
- (22) **Esitamise päev** 24.03.2009
- (24) **Registreeringu kehtivuse alguse päev** 24.03.2009
- (18) **Registreeringu kehtivuse lõppemise päev** 24.03.2014
- (28) **Variantide arv** 1
- (72) **Autor** Veiko Liis, Laada 23-4, Rakvere, 44310 Lääne-Viru maakond, EE
- (73) **Omanik** Foldplast OÜ, Kuiv 15, 11614 Tallinn, EE

(51) Klass: **07-01**

(54) **Nimetus** **Voldikkann**

(55) **Reproduksioon**

01523-1

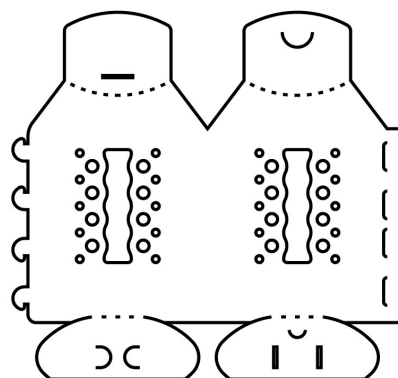
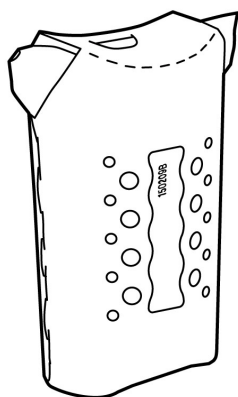

(11) Registreeringu number	<b>01524</b>	(51) Klass: <b>12-16</b>
(21) Taotluse number	D200900025	
(15) Registreerimise päev	17.08.2009	
(22) Esitamise päev	26.03.2009	
(24) Registreeringu kehtivuse alguse päev	26.03.2009	
(18) Registreeringu kehtivuse lõppemise päev	26.03.2014	
(28) Variantide arv	1	
(72) Autor	Priit Saaremets, Lehola küla, Keila vald, 76612 Harju maakond, EE	
(73) Omanik	AS Bestnet, Lehola küla, Keila vald, 76612 Harju maakond, EE	
(74) Patendivolinik või ühine esindaja	Ott Moorlat	

(54) Nimetus **Haagise veopealukk**

(55) Reproduktsoon

01524-1

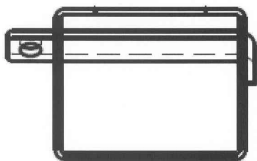
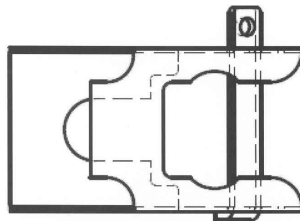
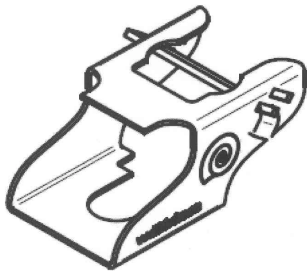

(11) Registreeringu number	<b>01525</b>	(51) Klass: <b>09-05</b>
(21) Taotluse number	D200900027	
(15) Registreerimise päev	17.08.2009	
(22) Esitamise päev	31.03.2009	
(24) Registreeringu kehtivuse alguse päev	31.03.2009	
(18) Registreeringu kehtivuse lõppemise päev	31.03.2014	
(28) Variantide arv	4	
(72) Autor	Kadri Mäe, Rao 12, 10913 Tallinn, EE Katrín Martinson, Näituse 3-8, 11623 Tallinn, EE	
(73) Omanik	Kadri Mäe, Rao 12, 10913 Tallinn, EE Katrín Martinson, Näituse 3-8, 11623 Tallinn, EE	

(54) Nimetus **Paberkott**

(55) Reproduktsoon

01525-1



01525-2



01525-3



01525-4



- (11) **Registreeringu number** **01526** (51) Klass: **21-01**
- (21) **Taotluse number** D200900029
- (15) **Registreerimise päev** 17.08.2009
- (22) **Esitamise päev** 14.04.2009
- (24) **Registreeringu kehtivuse alguse päev** 14.04.2009
- (18) **Registreeringu kehtivuse lõppemise päev** 14.04.2014
- (28) **Variantide arv** 1
- (72) **Autor** Kuido Viilver, Vägiheina tee 54, Maardu, 74114 Harju maakond, EE
- (73) **Omanik** Kuido Viilver, Vägiheina tee 54, Maardu, 74114 Harju maakond, EE
- (74) **Patendivolinik või ühine esindaja** Lembit Mitt
- (54) **Nimetus** **Lauamäng**
- (55) **Reproduktsoon**

01526-1



(11) Registreeringu number	<b>01527</b>	(51) Klass: <b>08-06</b>
(21) Taotluse number	D200900030	
(15) Registreerimise päev	17.08.2009	
(22) Esitamise päev	20.04.2009	
(24) Registreeringu kehtivuse alguse päev	20.04.2009	
(18) Registreeringu kehtivuse lõppemise päev	20.04.2014	
(28) Variantide arv	2	
(30) Prioriteediandmed	M20080192, 18.11.2008, FI	
(72) Autor	Mika Heikinmatti, Muotialantie 12, FI-33800 Tampere, FI Davide Lamparelli, Laivanvarustajankatu 10 G 66, FI-00140 Helsinki, FI Ristomatti Ratia, Kalliolinnantie 1 E, FI-00140 Helsinki, FI	
(73) Omanik	Abloy Oy, Wahlforssinkatu 20, FI-80100 Joensuu, FI	
(74) Patendivolinik või ühine esindaja	Lembit Mitt	

(54) Nimetus **Käepide**

(55) Reproduktsoon

01527-1

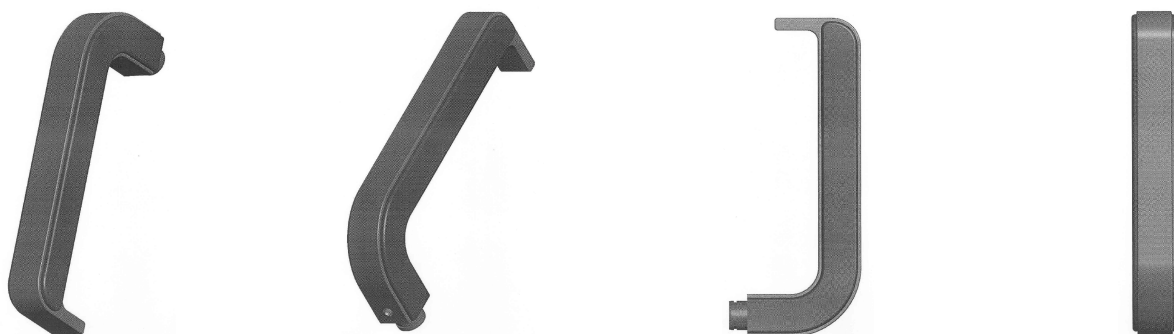

01527-2



- (11) **Registreeringu number** **01528** (51) Klass: **11-02**
- (21) **Taotluse number** D200900041
- (15) **Registreerimise päev** 17.08.2009
- (22) **Esitamise päev** 13.05.2009
- (24) **Registreeringu kehtivuse alguse päev** 13.05.2009
- (18) **Registreeringu kehtivuse lõppemise päev** 13.05.2014
- (28) **Variantide arv** 1
- (72) **Autor** Kadi Pajupuu, Paldiski mnt 227-162, 13520 Tallinn, EE
- (73) **Omanik** Kadi Pajupuu, Paldiski mnt 227-162, 13520 Tallinn, EE
- (54) **Nimetus** **Puust ja paest suveniirnukk**
- (55) **Reproduktsoon**

01528-1

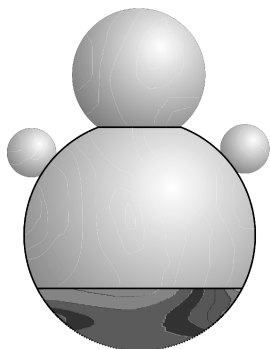

(11) **Registreeringu number** **01529**

(51) Klass: **02-01**

(21) **Taotluse number** D200900010

(15) **Registreerimise päev** 17.08.2009

(22) **Esitamise päev** 10.02.2009

(24) **Registreeringu kehtivuse alguse päev** 10.02.2009

(18) **Registreeringu kehtivuse lõppemise päev** 10.02.2014

(28) **Variantide arv** 1

(72) **Autor** Paul Pajos, Lõime 12-11, 10312 Tallinn, EE

(73) **Omanik** Paul Pajos, Lõime 12-11, 10312 Tallinn, EE

(54) **Nimetus** **Rinnahoidja**

(55) **Reproduktsoon**

01529-1





(11) Registreeringu number	<b>01530</b>
(21) Taotluse number	D200900028
(15) Registreerimise päev	17.08.2009
(22) Esitamise päev	03.04.2009
(24) Registreeringu kehtivuse alguse päev	03.04.2009
(18) Registreeringu kehtivuse lõppemise päev	03.04.2014
(28) Variantide arv	2
(72) Autor	Kärt Summatavet, Kopli 98, 11711 Tallinn, EE
(73) Omanik	Kärt Summatavet, Kopli 98, 11711 Tallinn, EE
(74) Patendivolinik või ühine esindaja	Ott Moorlat

(51) Klass: **11-03**(54) Nimetus **Rinnamärk**

(55) Reproduktsoon

01530-1

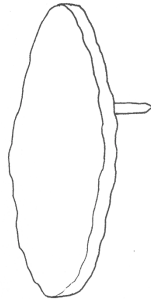

01530-2

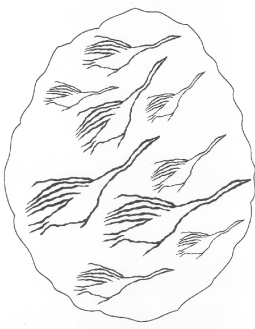

(11) **Registreeringu number** **01531**

(51) Klass: **23-02**

(21) **Taotluse number** D200900032

(15) **Registreerimise päev** 17.08.2009

(22) **Esitamise päev** 27.04.2009

(24) **Registreeringu kehtivuse  
alguse päev** 27.04.2009

(18) **Registreeringu kehtivuse  
lõppemise päev** 27.04.2014

(28) **Variantide arv** 1

(72) **Autor** We Think AB / Johan Kauppi, Norra Allégatan 7, 41301 Göteborg, SE

(73) **Omanik** Eumar Santehnika OÜ, Betooni 11a, 11415 Tallinn, EE

(54) **Nimetus** **Valamu**

(55) **Reproduksioon**

01531-1

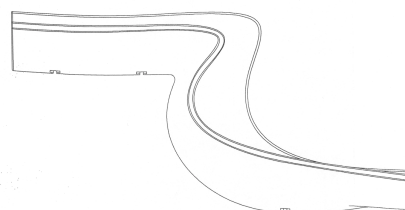
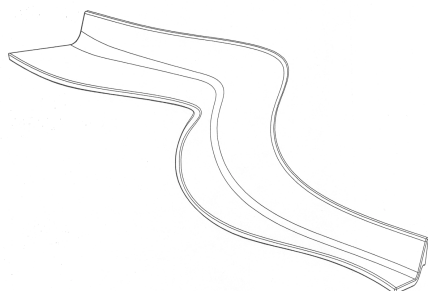

(11) **Registreeringu number** **01532**

(51) Klass: **02-02**

(21) **Taotluse number** D200900042

(15) **Registreerimise päev** 17.08.2009

(22) **Esitamise päev** 25.05.2009

(24) **Registreeringu kehtivuse alguse päev** 25.05.2009

(18) **Registreeringu kehtivuse lõppemise päev** 25.05.2014

(28) **Variantide arv** 2

(72) **Autor** Mari Lakspere, Kakumäe tee 257, 13516 Tallinn, EE

(73) **Omanik** Mari Lakspere, Kakumäe tee 257, 13516 Tallinn, EE

(74) **Patendivolinik või ühine esindaja** Ott Moorlat

(54) **Nimetus** **T-särk**

(55) **Reproduktsoon**

01532-1



01532-2



(11) Registreeringu number	<b>01533</b>	(51) Klass: <b>02-02</b>
(21) Taotluse number	D200900043	
(15) Registreerimise päev	17.08.2009	
(22) Esitamise päev	25.05.2009	
(24) Registreeringu kehtivuse alguse päev	25.05.2009	
(18) Registreeringu kehtivuse lõppemise päev	25.05.2014	
(28) Variantide arv	1	
(72) Autor	Mari Lakspere, Kakumäe tee 257, 13516 Tallinn, EE	
(73) Omanik	Mari Lakspere, Kakumäe tee 257, 13516 Tallinn, EE	
(74) Patendivolinik või ühine esindaja	Ott Moorlat	

(54) Nimetus **Kapuutsiga pluus**

(55) Reproduktsoon

01533-1

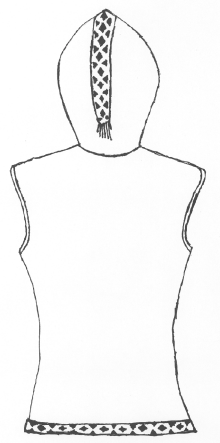
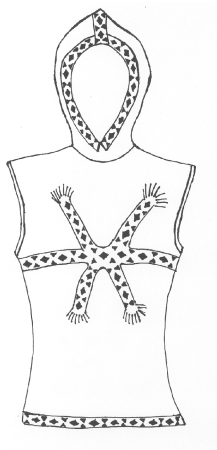

(11) **Registreeringu number** **01534**

(51) Klass: **02-02**

(21) **Taotluse number** D200900044

(15) **Registreerimise päev** 17.08.2009

(22) **Esitamise päev** 25.05.2009

(24) **Registreeringu kehtivuse alguse päev** 25.05.2009

(18) **Registreeringu kehtivuse lõppemise päev** 25.05.2014

(28) **Variantide arv** 1

(72) **Autor** Mari Laksperre, Kakumäe tee 257, 13516 Tallinn, EE

(73) **Omanik** Mari Laksperre, Kakumäe tee 257, 13516 Tallinn, EE

(74) **Patendivolinik või ühine esindaja** Ott Moorlat

(54) **Nimetus** **T-särk**

(55) **Reproduktsoon**

01534-1



(11) Registreeringu number	<b>01535</b>	(51) Klass: <b>19-08</b>
(21) Taotluse number	D200900050	
(15) Registreerimise päev	17.08.2009	
(22) Esitamise päev	10.06.2009	
(24) Registreeringu kehtivuse alguse päev	10.06.2009	
(18) Registreeringu kehtivuse lõppemise päev	10.06.2014	
(28) Variantide arv	2	
(72) Autor	Vitaly Zinichenko, Keskuse 4-21, 12129 Tallinn, EE	
(73) Omanik	Vitaly Zinichenko, Keskuse 4-21, 12129 Tallinn, EE Raivo Raidam, Raja 7a-4, 12616 Tallinn, EE	
(74) Patendivolinik või ühine esindaja	Ott Moorlat	

(54) Nimetus **Etikettide komplekt**

(55) Reproduktsoon

01535-1



01535-2



- (11) **Registreeringu number** **01536** (51) Klass: **19-08**
- (21) **Taotluse number** D200900051
- (15) **Registreerimise päev** 17.08.2009
- (22) **Esitamise päev** 10.06.2009
- (24) **Registreeringu kehtivuse alguse päev** 10.06.2009
- (18) **Registreeringu kehtivuse lõppemise päev** 10.06.2014
- (28) **Variantide arv** 2
- (72) **Autor** Vitaly Zinichenko, Keskuse 4-21, 12129 Tallinn, EE
- (73) **Omanik** Vitaly Zinichenko, Keskuse 4-21, 12129 Tallinn, EE  
Raivo Raidam, Raja 7a-4, 12616 Tallinn, EE
- (74) **Patendivolinik või ühine esindaja** Ott Moorlat
- (54) **Nimetus** **Etikettide komplekt**
- (55) **Reproduktsoon**
- 01536-1



---

01536-2



- (11) **Registreeringu number** **01537** (51) Klass: **08-05**
- (21) **Taotluse number** D200900053
- (15) **Registreerimise päev** 17.08.2009
- (22) **Esitamise päev** 18.06.2009
- (24) **Registreeringu kehtivuse alguse päev** 18.06.2009
- (18) **Registreeringu kehtivuse lõppemise päev** 18.06.2014
- (28) **Variantide arv** 2
- (72) **Autor** Heino Engel, Mündi tee 22, Randvere küla, Viimsi, 74016 Harju maakond, EE  
Nikolai Fedeiko, K. Kärberi 14-18, 13812 Tallinn, EE  
Sergei Konenko, Kotka 18-11, 11312 Tallinn, EE  
Valentin Timofejev, Sõle 37-47, 10321 Tallinn, EE
- (73) **Omanik** AS ENKO, Tulbiaia tee 3, Viimsi, 74001 Harju maakond, EE
- (74) **Patendivolinik või ühine esindaja** Jaak Ostrat

(54) **Nimetus** **Montaaživahu päästik-aplikaator**

(55) **Reproduktsoon**

01537-1

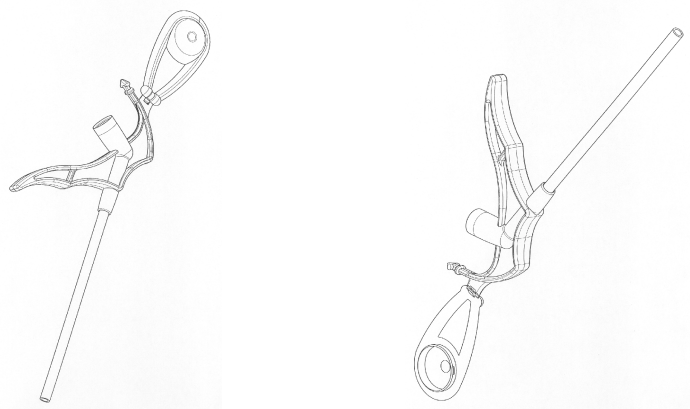

01537-2

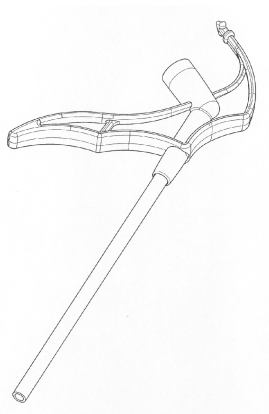



- (11) **Registreeringu number** **01538** (51) Klass: **06-01**
- (21) **Taotluse number** D200900054
- (15) **Registreerimise päev** 17.08.2009
- (22) **Esitamise päev** 19.06.2009
- (24) **Registreeringu kehtivuse alguse päev** 19.06.2009
- (18) **Registreeringu kehtivuse lõppemise päev** 19.06.2014
- (28) **Variantide arv** 2
- (72) **Autor** Piret Pihtjõe, Pearnal talu, Tuula küla, Saue vald, 76618 Harju maakond, EE
- (73) **Omanik** Piret Pihtjõe, Pearnal talu, Tuula küla, Saue vald, 76618 Harju maakond, EE

(54) **Nimetus** **Aiatool**

(55) **Reproduktsoon**

01538-1



01538-2



- (11) **Registreeringu number** **01539** (51) Klass: **06-01**
- (21) **Taotluse number** D200900055
- (15) **Registreerimise päev** 17.08.2009
- (22) **Esitamise päev** 19.06.2009
- (24) **Registreeringu kehtivuse alguse päev** 19.06.2009
- (18) **Registreeringu kehtivuse lõppemise päev** 19.06.2014
- (28) **Variantide arv** 2
- (72) **Autor** Piret Pihtjõe, Pearnä talu, 76618 Saue vald, Harjumaa, EE
- (73) **Omanik** Piret Pihtjõe, Pearnä talu, Tuula küla, Saue vald, 76618 Harju maakond, EE

(54) **Nimetus** **Aiatool**

(55) **Reproduktsoon**

01539-1



01539-2



(11) **Registreeringu number** **01540**

(51) Klass: **25-01**

(21) **Taotluse number** D200900056

(15) **Registreerimise päev** 17.08.2009

(22) **Esitamise päev** 22.06.2009

(24) **Registreeringu kehtivuse  
alguse päev** 22.06.2009

(18) **Registreeringu kehtivuse  
lõppemise päev** 22.06.2014

(28) **Variantide arv** 1

(72) **Autor** Juri Petrov, Liikuri 50-118, 13618 Tallinn, EE

(73) **Omanik** Juri Petrov, Liikuri 50-118, 13618 Tallinn, EE

(74) **Patendivolinik või ühine esindaja** Ljubov Kesselman

(54) **Nimetus** **Dekoratiivpaneel**

(55) **Reproduktsoon**

01540-1



## **II. RAHVUSVAHELISELT REGISTREERITUD TÖÖSTUSDISAINILAHENDUSED**

Avaldatakse "Tööstusdisaini kaitse seaduse" § 87<sup>4</sup> lõike 3 alusel. Patendiamet ei ole kontrollinud tööstusdisainilahenduse uudsust ja eristatavust tulenevalt "Tööstusdisaini kaitse seaduse" § 31 lõike 2 punktist 1.

(11) **Rahvusvah reg nr**

**DM/070105**

(51) Klass: **26-06**

(21) **Rahvusvah reg jrk**

H200800043

(15) **Registreeringu päev**

06.05.2008

(28) **Variantide arv**

2

(72) **Autor**

Jaroslav Hejtmanek

Volker Leutz

Gerd Stolz

Thomas Stopka

DAIMLER AG, Mercedesstrasse 137, 70327 Stuttgart, DE

(73) **Omanik**

**WIPO Rahvusvah Tööstusdisainilahenduste**

**Bülletääni nr, kus registreering on avaldatud** 2008/10

(55) **Reproduksioon**

DM/070105-1



DM/070105-2



(11) <b>Rahvusvah reg nr</b>	<b>DM/070164</b>	(51) <b>Klass: 12-16</b>
(21) <b>Rahvusvah reg jrk</b>	H200800042	
(15) <b>Registreeringu päev</b>	14.05.2008	
(28) <b>Variantide arv</b>	1	
(72) <b>Autor</b>	Hans-Dieter Futschik Stefan Handt Steffen Koehl Frank Pfisterer	
(73) <b>Omanik</b>	DAIMLER AG, Mercedesstrasse 137, 70327 Stuttgart, DE	
<b>WIPO Rahvusvah Tööstusdisainilahenduste Bülletääni nr, kus registreering on avaldatud</b>	2008/10	

(55) **Reproduksioon**

DM/070164-1

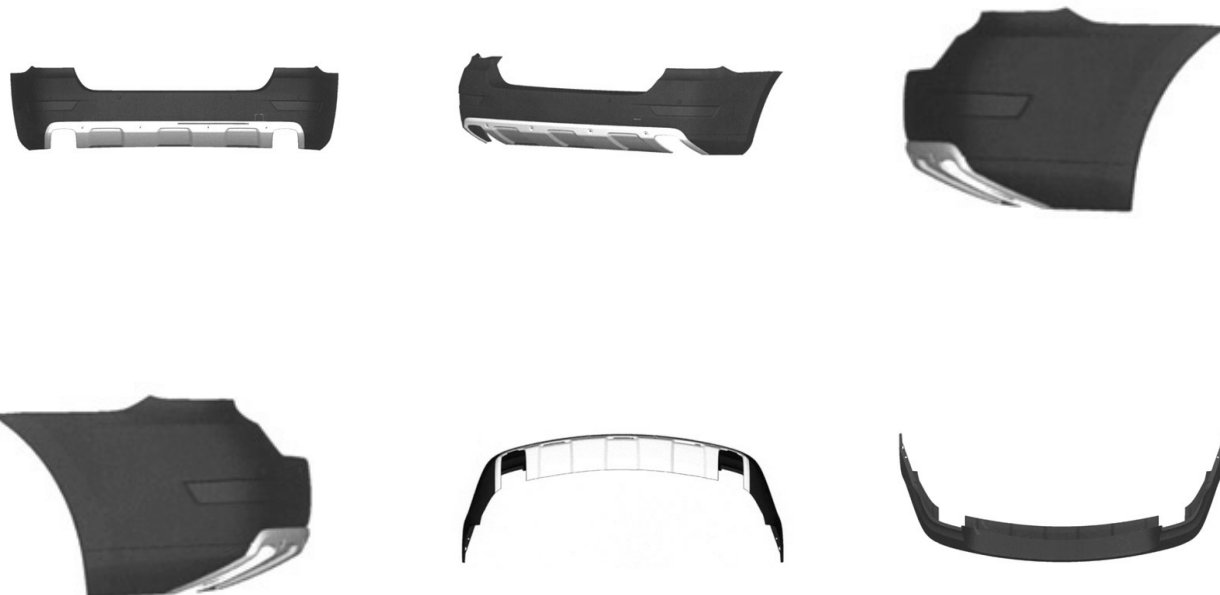

(11) <b>Rahvusvah reg nr</b>	<b>DM/070170</b>	(51) Klass: <b>12-16</b>
(21) <b>Rahvusvah reg jrk</b>	H200800040	
(15) <b>Registreeringu päev</b>	19.05.2008	
(28) <b>Variantide arv</b>	1	
(72) <b>Autor</b>	Volker Leutz Gerd Stolz Thomas Stopka	
(73) <b>Omanik</b>	DAIMLER AG, Mercedesstrasse 137, 70327 Stuttgart, DE	
<b>WIPO Rahvusvah Tööstusdisainilahenduste Bülletääni nr, kus registreering on avaldatud</b>	2008/10	

(55) **Reproduksioon**

DM/070170-1

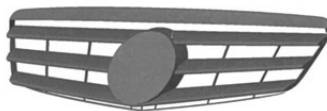
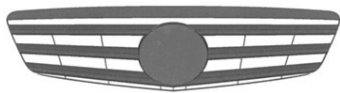

(11) <b>Rahvusvah reg nr</b>	<b>DM/070173</b>	(51) <b>Klass: 12-16</b>
(21) <b>Rahvusvah reg jrk</b>	H200800039	
(15) <b>Registreeringu päev</b>	19.05.2008	
(28) <b>Variantide arv</b>	1	
(72) <b>Autor</b>	Volker Leutz Gerd Stolz Thomas Stopka	
(73) <b>Omanik</b>	DAIMLER AG, Mercedesstrasse 137, 70327 Stuttgart, DE	
<b>WIPO Rahvusvah Tööstusdisainilahenduste Bülletääni nr, kus registreering on avaldatud</b>	2008/10	

(55) **Reproduksioon**

DM/070173-1





(11) <b>Rahvusvah reg nr</b>	<b>DM/070187</b>	(51) Klass: <b>26-06</b>
(21) <b>Rahvusvah reg jrk</b>	H200800038	
(15) <b>Registreeringu päev</b>	14.05.2008	
(28) <b>Variantide arv</b>	2	
(72) <b>Autor</b>	Hans-Dieter Futschik Stefan Handt Steffen Koehl Frank Pfisterer	
(73) <b>Omanik</b>	DAIMLER AG, Mercedesstrasse 137, 70327 Stuttgart, DE	
<b>WIPO Rahvusvah Tööstusdisainilahenduste Bülletääni nr, kus registreering on avaldatud</b>	2008/10	

(55) **Reproduksioon**

DM/070187-1

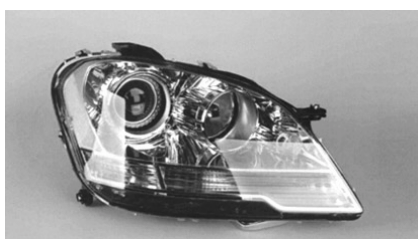

DM/070187-2

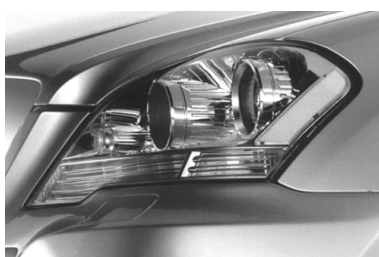

(11) **Rahvusvah reg nr**

**DM/070475**

(51) Klass: **06-01**

(21) **Rahvusvah reg jrk**

H200800020

(15) **Registreeringu päev**

02.06.2008

(22) **Esitamise päev**

06.02.2008

(28) **Variantide arv**

1

(72) **Autor**

Steven Schilte

(73) **Omanik**

MACHALKE POLSTERWERKSTÄTTEN, Burkheimer Str. 20,  
96272 Hochstadt, DE

**WIPO Rahvusvah Tööstusdisainilahenduste**

**Bülletääni nr, kus registreering on avaldatud** 2008/07

(55) **Reproduksioon**

DM/070475-1



(11) **Rahvusvah reg nr**

**DM/070476**

(51) Klass: **06-01**

(21) **Rahvusvah reg jrk**

H200800019

(15) **Registreeringu päev**

02.06.2008

(22) **Esitamise päev**

06.02.2008

(28) **Variantide arv**

1

(72) **Autor**

Peter Wernecke

(73) **Omanik**

MACHALKE POLSTERWERKSTÄTTEN, Burkheimer Str. 20,  
96272 Hochstadt, DE

**WIPO Rahvusvah Tööstusdisainilahenduste**

**Bülletääni nr, kus registreering on avaldatud** 2008/07

(55) **Reproduksioon**

DM/070476-1



(11) **Rahvusvah reg nr**

**DM/070603**

(51) Klass: **23-04**

(21) **Rahvusvah reg jrk**

H200900009

(15) **Registreeringu päev**

21.05.2008

(28) **Variantide arv**

1

(72) **Autor**

Autorit ei avalikustata

(73) **Omanik**

COPLAX AG, Charmerstrasse 174, CH-6300 Zug, CH

**WIPO Rahvusvah Tööstusdisainilahenduste**

**Bülletääni nr, kus registreering on avaldatud** 2009/04

(55) **Reproduktsoon**

DM/070603-1

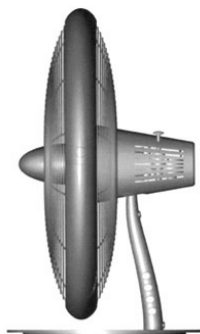
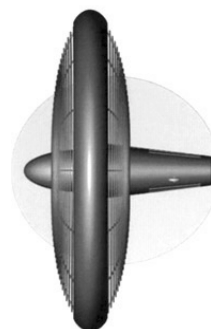
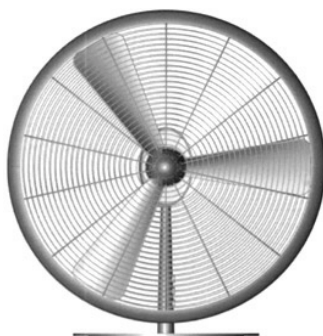

(11) <b>Rahvusvah reg nr</b>	<b>DM/070632</b>	(51) Klass: <b>04-04</b>
(21) <b>Rahvusvah reg jrk</b>	H200800033	
(15) <b>Registreeringu päev</b>	29.08.2008	
(28) <b>Variantide arv</b>	2	
(72) <b>Autor</b>	Autorit ei avalikustata	
(73) <b>Omanik</b>	VILAIN MARCEL ET FILS, Rue du Château 64, B-6183 Trazegnies, BE	
<b>WIPO Rahvusvah Tööstusdisainilahenduste Bülletääni nr, kus registreering on avaldatud</b>	2008/09	

(55) **Reproduksioon**

DM/070632-1

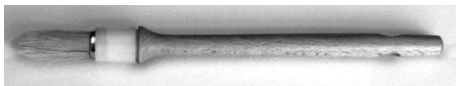

---

DM/070632-2

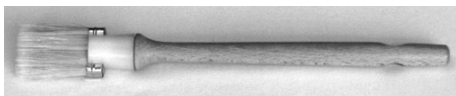

(11) **Rahvusvah reg nr** DM/070826 (51) Klass: **09-02**  
(21) **Rahvusvah reg jrk** H200900007  
(15) **Registreeringu päev** 10.10.2008  
(28) **Variantide arv** 1  
(72) **Autor** Béatrice Salotti  
(73) **Omanik** TOTAL SA, 2, Place Jean Millier, La Défense 6, F-92400 COURBEVOIE, FR

**WIPO Rahvusvah Tööstusdisainilahenduste**  
**Bülletääni nr, kus registreering on avaldatud** 03/2009

(55) **Reproduksioon**

DM/070826-1

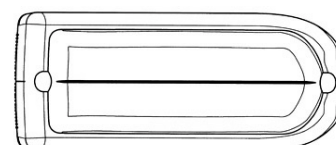
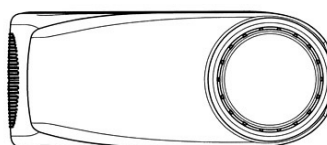
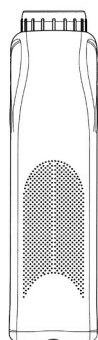
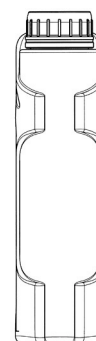
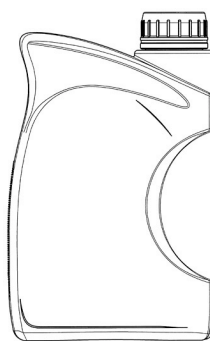
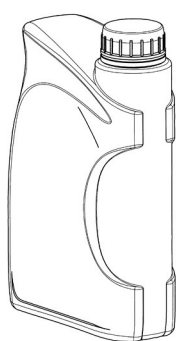

(11) **Rahvusvah reg nr****DM/070849**(51) Klass: **24-01**(21) **Rahvusvah reg jrk**

H200800036

(15) **Registreeringu päev**

13.12.2007

(28) **Variantide arv**

4

(72) **Autor**

Hakan Olsson

(73) **Omanik**GAMBRO INDUSTRIES (SAS), 7 avenue Lionel Terray,  
F-69330 Meyzieu, FR**WIPO Rahvusvah Tööstusdisainilahenduste**  
**Bülletääni nr, kus registreering on avaldatud** 2008/10(55) **Reproduktsoon**

DM/070849-1

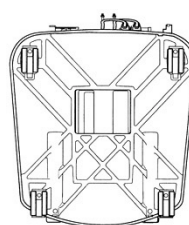
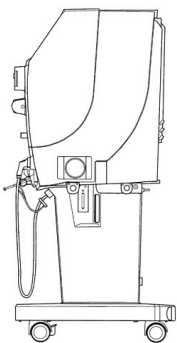
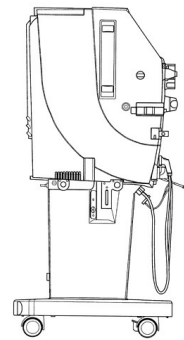
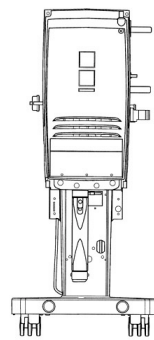
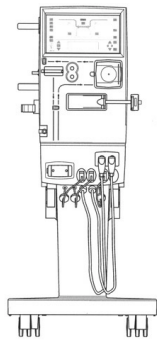
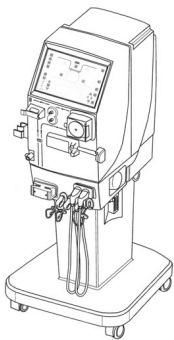

DM/070849-2

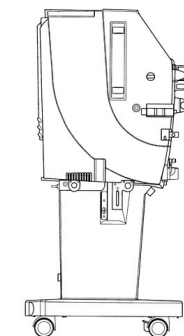
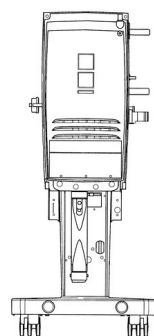
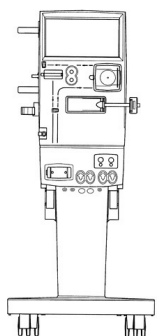
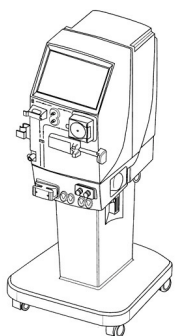

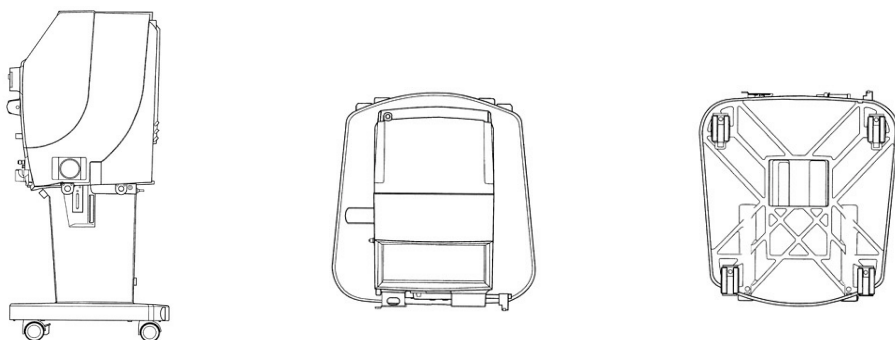

DM/070849-3

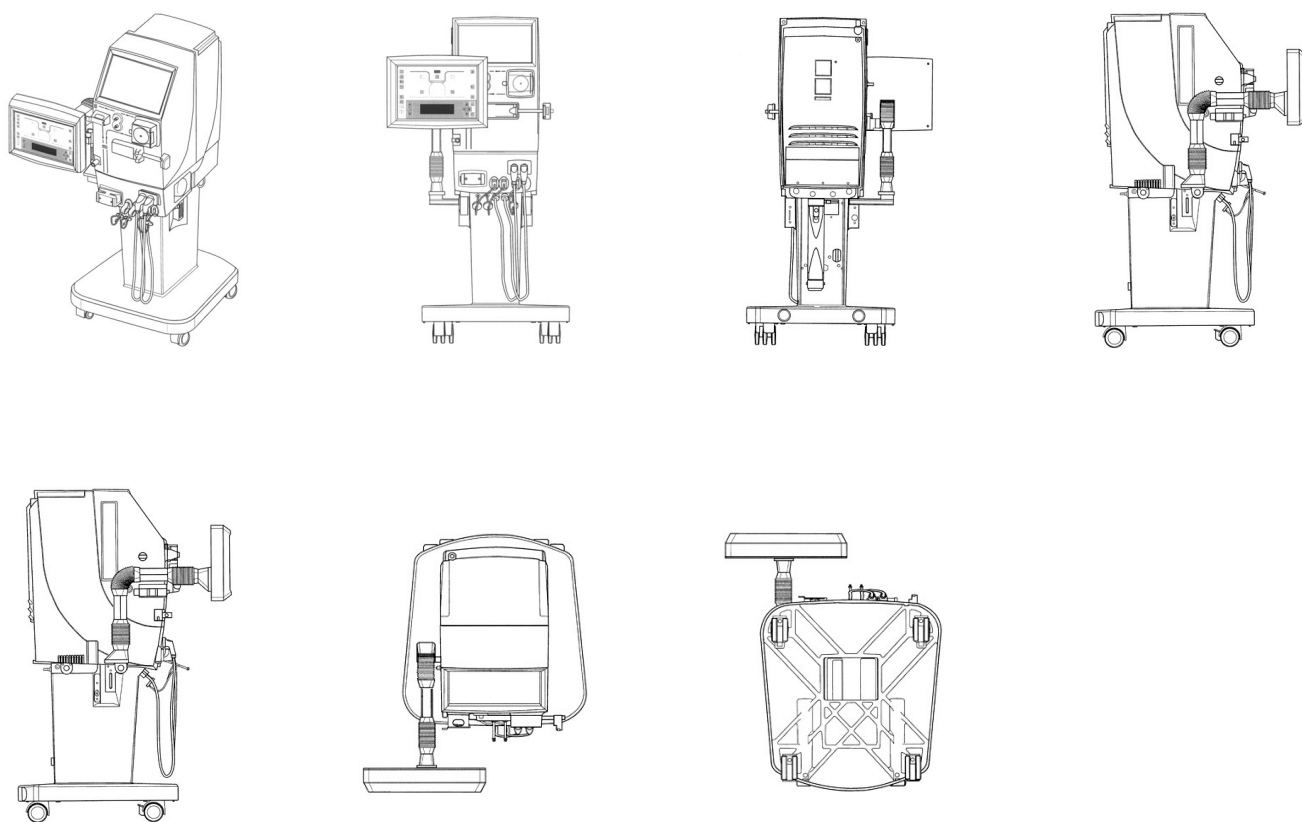

DM/070849-4

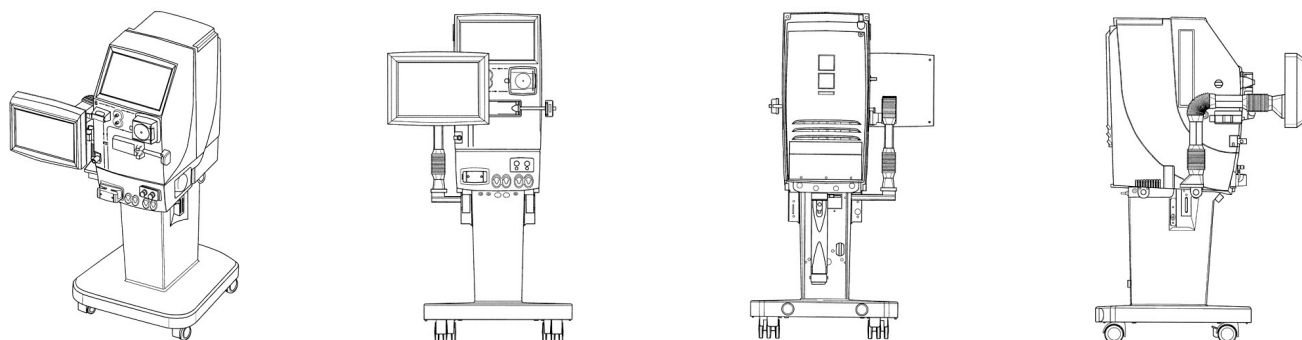



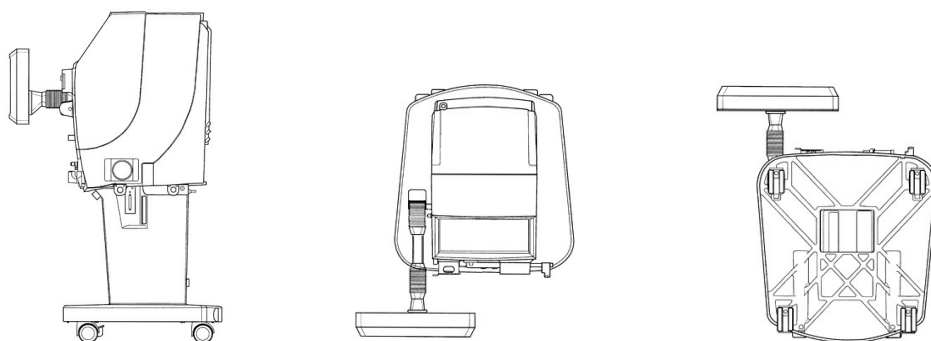

(11) **Rahvusvah reg nr**

**DM/071311**

(51) Klass: **09-07**

(21) **Rahvusvah reg jrk**

H200900006

(15) **Registreeringu päev**

28.10.2008

(22) **Esitamise päev**

06.08.2008

(28) **Variantide arv**

1

(72) **Autor**

Shadypack for packing Medicinal & Foodstuffs

(73) **Omanik**

Shadypack for packing Medicinal & Foodstuffs, Al Obour City,  
Industrial Zone, Piece No 3 Block 1316, Cairo, EG

**WIPO Rahvusvah Tööstusdisainilahenduste**

**Bülletääni nr, kus registreering on avaldatud** 03/2009

(55) **Reproduksioon**

DM/071311-1



(11) **Rahvusvah reg nr**

**DM/071332**

(51) **Klass: 14-03**

(21) **Rahvusvah reg jrk**

H200900005

(15) **Registreeringu päev**

03.10.2008

(28) **Variantide arv**

3

(72) **Autor**

Piero Gandini

(73) **Omanik**

FLOS S.P.A., Via A. Faini, 2, I-25073 Bovezzo (Brescia), IT

**WIPO Rahvusvah Tööstusdisainilahenduste**

**Bülletääni nr, kus registreering on avaldatud** 03/2009

(55) **Reproduksioon**

DM/071332-1

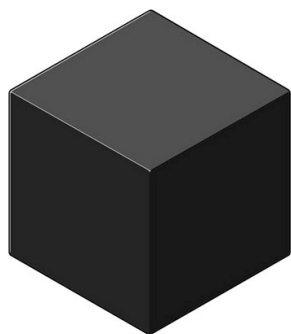

DM/071332-2

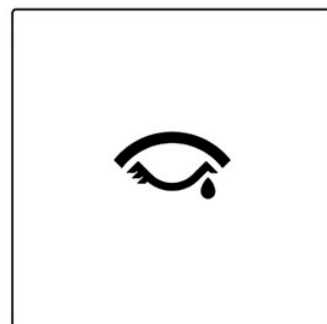
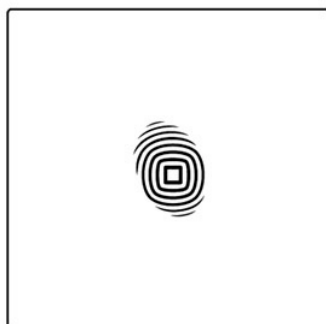
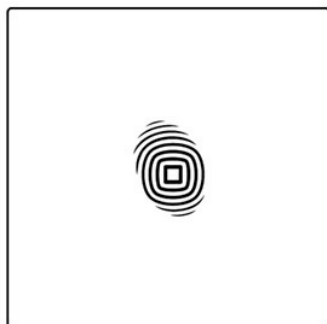
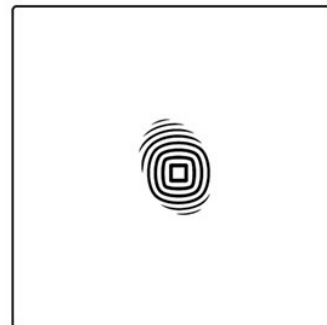
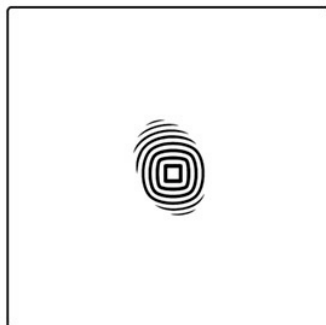
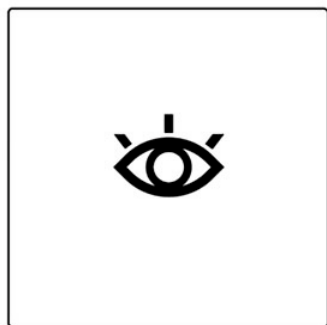

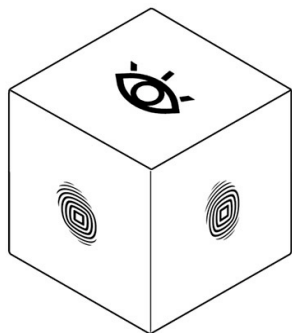

DM/071332-3



(11) **Rahvusvah reg nr** **DM/071380** (51) Klass: **06-01**  
(21) **Rahvusvah reg jrk** H200900003  
(15) **Registreeringu päev** 07.01.2009  
(28) **Variantide arv** 1  
(72) **Autor** Designwerk Fuchs-Lausser  
(73) **Omanik** MACHALKE POLSTERWERKSTÄTTEN, Burkheimer Str. 20,  
96272 Hochstadt, DE

**WIPO Rahvusvah Tööstusdisainilahenduste**  
**Bülletääni nr, kus registreering on avaldatud** 2/2009

(55) **Reproduksioon**

DM/071380-1

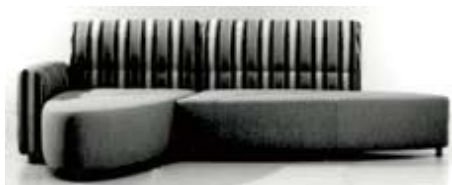

(11) **Rahvusvah reg nr**

**DM/071381**

(51) Klass: **06-01**

(21) **Rahvusvah reg jrk**

H200900002

(15) **Registreeringu päev**

07.01.2009

(28) **Variantide arv**

1

(72) **Autor**

Müller Wulff GmbH

(73) **Omanik**

MACHALKE POLSTERWERKSTÄTTEN, Burkheimer Str. 20,  
96272 Hochstadt, DE

**WIPO Rahvusvah Tööstusdisainilahenduste  
Bülletääni nr, kus registreering on avaldatud**

2009/2

(55) **Reproduksioon**

DM/071381-1

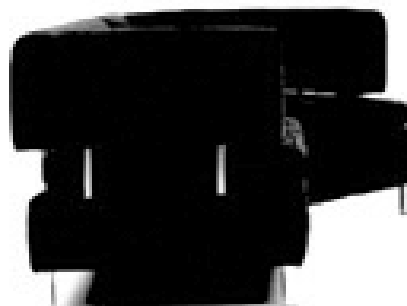
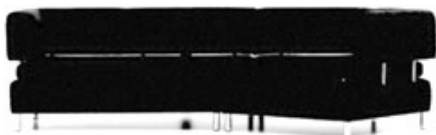

**III. MUUD REGISTRIKANDED****REGISTREERINGU KEHTIVUSE PIKENDAMINE**

Reg nr	Registreeringu pikendatud kehtivusaja lõppemise päev
--------	--

00382	12.08.2014
00946	24.03.2014
00969	07.05.2014
00984	15.07.2014
00998	03.09.2014
00999	24.08.2014
01012	15.10.2014
01013	15.10.2014

**REGISTREERINGU ANDMETE MUUDATUSED**

Reg nr	Muutunud andmed	Registrikande jõustumise päev
00946	Agentia Agroindustrială Moldova-Vin, bl. Stefan cel Mare, 162, MD-2004 Chisinau, MD	01.07.2009
00946	Urmas Kauler, Patendibüroo TURVAJA OÜ, Liivalaia 22, 10118 Tallinn, EE	01.07.2009

**REGISTREERINGU KUSTUTAMINE**

"Tööstusdisaini kaitse seaduse" paragrahvi 77 lõike 1 alusel on registrist kustutatud järgmised tööstusdisainilahendused:

Reg nr	Kustutamise kande jõustumise päev
--------	-----------------------------------

00325	17.11.2008	00889	28.11.2008	00903	22.12.2008
00350	23.12.2008	00890	28.11.2008	00904	22.12.2008
00356	27.10.2008	00891	28.11.2008	00905	29.12.2008
00357	06.01.2009	00892	28.11.2008	00906	29.12.2008
00871	24.10.2008	00893	04.12.2008	00907	29.12.2008
00873	28.10.2008	00894	04.12.2008	00908	30.12.2008
00874	06.11.2008	00895	04.12.2008	00909	30.12.2008
00884	11.11.2008	00896	04.12.2008	00910	30.12.2008
00885	20.11.2008	00897	15.12.2008	00921	28.11.2008
00886	28.11.2008	00898	15.12.2008	00931	04.12.2008
00887	28.11.2008	00899	15.12.2008	00935	02.01.2009
00888	28.11.2008	00902	22.12.2008		

## IV. LOENDID

REGISTREERITUD TÖÖSTUSDISAINILAHENDUSTE REGISTREERIMISE TAOTLUSTE  
NUMBRILINE LOEND

Registreerimis- taotluse number	Registreeringu number
------------------------------------	--------------------------

D200900010	01529	D200900041	01528
D200900021	01521	D200900042	01532
D200900022	01522	D200900043	01533
D200900024	01523	D200900044	01534
D200900025	01524	D200900050	01535
D200900027	01525	D200900051	01536
D200900028	01530	D200900053	01537
D200900029	01526	D200900054	01538
D200900030	01527	D200900055	01539
D200900032	01531	D200900056	01540

RAHVUSVAHELISELT REGISTREERITUD TÖÖSTUSDISAINILAHENDUSTE  
NUMBRILINE LOEND

Rahvusvah reg jrk	Rahvusvah reg nr
-------------------	------------------

H200800019	DM/070476	H200800043	DM/070105
H200800020	DM/070475	H200900002	DM/071381
H200800033	DM/070632	H200900003	DM/071380
H200800036	DM/070849	H200900005	DM/071332
H200800038	DM/070187	H200900006	DM/071311
H200800039	DM/070173	H200900007	DM/070826
H200800040	DM/070170	H200900009	DM/070603
H200800042	DM/070164		

## V. TÖÖSTUSDISAINIALASED ÕIGUSAKTID JA MUU INFO

RIIKLIKUS PATENDIVOLNIKE REGISTRIS REGISTREERITUD PATENDIVOLNIKE NIMEKIRI  
(seisuga 4. juuni 2009)

Register on asutatud 1. septembril 2001. a Vabariigi Valitsuse 7. augusti 2001. a määrusega nr 271 "Riikliku patendivolinike registri asutamine ja registri pidamise põhimäärus" (RT I 2001, 70, 426) patendivoliniku seaduse § 21 alusel (RT I 2001, 27, 151).

## TEGEVUSVALDKOND: KAUBAMÄRK, TÖÖSTUSDISAINILAHENDUS JA GEOGRAAFILINE TÄHIS

<b>Arno ANIJALG</b>	<b>OÜ USTERVALL</b> Kivi 21-6 51009 Tartu pk 21, 51002 Tartu telefon: 744 1980 telefaks: 744 1785 e-post: anijalg@ustervall.ee http://www.ustervall.ee võõrkeeled: saksa, vene	<b>Juhan HÄMMALOV</b>	<b>OÜ Intels</b> Magasini 12 51005 Tartu telefon: 742 0401 telefaks: 742 0326 e-post: intels@intels.ee http://www.intels.ee võõrkeeled: inglise, saksa, vene
<b>Aivo ARULA</b>	<b>Patendibüroo Käosaar &amp; Co OÜ</b> Tähe 94 50107 Tartu telefon: 738 3051 telefaks: 738 3055 e-post: info@kaosaar.ee http://www.kaosaar.ee võõrkeeled: inglise, vene	<b>Uno JÄÄGER</b>	<b>Inseneribüroo Uneko OÜ</b> Rüütli 51a, 80010 Pärnu telefon: 447 1021 telefaks: 447 1001 GSM: 515 1844 e-post: info@uneko.ee http://www.uneko.ee võõrkeeled: inglise, soome, vene
<b>Martina BÖCKLER-LORVI</b>	<b>OÜ LASVET</b> Suurtüki 4a, 10133 Tallinn pk 3136, 10505 Tallinn telefon: 640 6600 telefaks: 640 6604 e-post: lasvet@lasvet.ee http://www.lasvet.ee võõrkeeled: inglise, soome	<b>Sirje KAHU</b>	<b>OÜ USTERVALL</b> Kivi 21-6 51009 Tartu pk 21, 51002 Tartu telefon: 744 1980 telefaks: 744 1785 e-post: skahu@ustervall.ee http://www.ustervall.ee võõrkeeled: inglise, vene
<b>Indrek EELMETS</b>	<b>Advokaadibüroo Sorainen OÜ</b> Pärnu mnt 15 10141 Tallinn telefon: 640 0900 telefaks: 640 0901 e-post: sorainen@sorainen.ee http://www.sorainen.com võõrkeeled: inglise, vene, soome	<b>Lembit KALEV</b>	<b>Patendibüroo ROOSILLA OÜ</b> Järveotsa tee 39-61 13520 Tallinn telefon: 657 1722, 657 5381 telefaks: 657 5381 GSM: 511 9951 e-post: roosilla@roosilla.ee http://www.roosilla.ee võõrkeeled: inglise, vene
<b>Alla HÄMMALOV</b>	<b>OÜ Intels</b> Magasini 12 51005 Tartu telefon: 742 0401 telefaks: 742 0326 e-post: intels@intels.ee http://www.intels.ee võõrkeeled: inglise, poola, vene	<b>Anneli KANG</b>	<b>OÜ Synest</b> pk 977, 13402 Tallinn telefon: 660 9786 telefaks: 660 9787 e-post: anneli@synest.ee võõrkeeled: inglise, saksa, vene, prantsuse, soome, rootsi



<b>Urmas KAULER</b>	<b>Patendibüroo TURVAJA OÜ</b> Liivalaia 22 10118 Tallinn telefon: 640 3109 telefaks: 640 3105 e-post: turvaja@turvaja.ee http://www.turvaja.ee võõrkeeled: inglise, vene, soome	<b>Katrin KOITEL-VEIDIK</b>	<b>Patendi- &amp; Kaubamärgibüroo Koitel OÜ</b> Tartu mnt 65 10115 Tallinn pk 1759, 10902 Tallinn telefon: 603 3260 telefaks: 603 3261 e-post: koitel@koitel.ee http://www.koitel.ee võõrkeeled: inglise, soome
<b>Urmas KERNU</b>	<b>AAA Patendibüroo OÜ</b> Tartu mnt 16 10117 Tallinn pk 3926, 10509 Tallinn telefon: 660 5910, 660 5911 telefaks: 660 5912 e-post: aaa@aaa.ee http://www.aaa.ee võõrkeeled: inglise, saksa, soome, vene	<b>Mart Enn KOPPEL</b>	<b>Patendibüroo Koppel OÜ</b> Kajaka 4-10 11317 Tallinn telefon: 677 4136 telefaks: 677 4138 e-post: info@koppelpb.com http://www.koppelpb.com võõrkeeled: inglise, vene, soome
<b>Ljubov KESSELMAN</b>	<b>OÜ Kesna</b> Tedre 77-52 10616 Tallinn telefon: 660 8068 telefaks: 660 8069 e-post: kesna@kesna.ee http://www.kesna.ee võõrkeeled: inglise, vene	<b>Heinrich KRUPP</b>	<b>Patendibüroo TURVAJA OÜ</b> Liivalaia 22 10118 Tallinn telefon: 640 3109 telefaks: 640 3105 e-post: turvaja@turvaja.ee http://www.turvaja.ee võõrkeeled: saksa, vene
<b>Marina KESSELMAN</b>	<b>OÜ Kesna</b> Tedre 77-52 10616 Tallinn telefon: 660 8068 telefaks: 660 8069 e-post: kesna@kesna.ee http://www.kesna.ee võõrkeeled: inglise, saksa, vene	<b>Jüri KÄOSAAR</b>	<b>Patendibüroo Käosaar &amp; Co OÜ</b> Tähe 94 50107 Tartu telefon: 738 3051 telefaks: 738 3055 e-post: info@kaosaar.ee http://www.kaosaar.ee võõrkeeled: inglise, vene
<b>Heinu KOITEL</b>	<b>Patendi- &amp; Kaubamärgibüroo Koitel OÜ</b> Tartu mnt 65 10115 Tallinn pk 1759, 10902 Tallinn telefon: 603 3260 telefaks: 603 3261 e-post: koitel@koitel.ee http://www.koitel.ee võõrkeeled: inglise, soome, vene	<b>Kalev KÄOSAAR</b>	<b>Patendibüroo Käosaar &amp; Co OÜ</b> Suur-Patarei 2 10415 Tallinn telefon: 637 9484 telefaks: 637 9485 e-post: kalev.kaosaar@kaosaar.ee http://www.kaosaar.ee võõrkeeled: inglise, vene
<b>Raivo KOITEL</b>	<b>Patendi- &amp; Kaubamärgibüroo Koitel OÜ</b> Tartu mnt 65 10115 Tallinn pk 1759, 10902 Tallinn telefon: 603 3260 telefaks: 603 3261 e-post: koitel@koitel.ee http://www.koitel.ee võõrkeeled: inglise, soome, vene	<b>Kristjan LEPIK</b>	<b>Patendibüroo TURVAJA OÜ</b> Liivalaia 22 10118 Tallinn telefon: 640 3109 telefaks: 640 3105 e-post: turvaja@turvaja.ee http://www.turvaja.ee võõrkeeled: inglise, vene

<b>Reet MAASIKAMÄE</b>	<b>OÜ Kaitsepurus</b> Mulla 4-3 10611 Tallinn telefon: 673 9097, 633 2798 telefaks: 677 4844 e-post: purus@hot.ee kaitsepurus@hot.ee http://www.hot.ee/purus/ võõrkeeled: inglise, vene	<b>Tõnu NELSAS</b>	<b>AAA Patendibüroo OÜ</b> Tartu mnt 16 10117 Tallinn pk 3926, 10509 Tallinn telefon: 660 5910, 660 5911 telefaks: 660 5912 e-post: aaa@aaa.ee http://www.aaa.ee võõrkeeled: inglise, vene, soome
<b>Raivo MATSOO</b>	<b>RM Hirvela Patendibüroo OÜ</b> Saku 15, 11314 Tallinn telefon: 614 0816 telefaks: 614 0818 e-post: hirvela@hirvela.ee võõrkeeled: inglise, vene	<b>Jüri OLT</b>	<b>Danteks OÜ</b> Tiigi 6, 51003 Tartu telefon: 508 1671 telefaks: 730 2844 e-post: jyri@danteks.net http://www.danteks.net võõrkeeled: inglise, saksa, soome, vene
<b>Elle MELLIK</b>	<b>AAA Patendibüroo OÜ</b> Tartu mnt 16 10117 Tallinn pk 3926, 10509 Tallinn telefon: 660 5910, 660 5911 telefaks: 660 5912 e-post: aaa@aaa.ee http://www.aaa.ee võõrkeeled: inglise, vene	<b>Jaak OSTRAT</b>	<b>OÜ LASVET</b> Suurtüki 4a, 10133 Tallinn pk 3136, 10505 Tallinn telefon: 640 6600 telefaks: 640 6604 e-post: lasvet@lasvet.ee http://www.lasvet.ee võõrkeeled: inglise, saksa, soome, vene
<b>Lembit MITT</b>	<b>AAA Patendibüroo OÜ</b> Tartu mnt 16, 10117 Tallinn pk 3926, 10509 Tallinn telefon: 660 5910, 660 5911 telefaks: 660 5912 e-post: aaa@aaa.ee http://www.aaa.ee võõrkeeled: inglise, vene	<b>Villu PAVELTS</b>	<b>OÜ LASVET</b> Suurtüki 4a, 10133 Tallinn pk 3136, 10505 Tallinn telefon: 640 6600 telefaks: 640 6604 e-post: lasvet@lasvet.ee http://www.lasvet.ee võõrkeeled: inglise, soome, vene
<b>Ott MOORLAT</b>	<b>OÜ Moorlat &amp; Ko Patendibüroo</b> pk 723, 12902 Tallinn telefon: 655 0450, 654 2844 telefaks: 654 2844 e-post: ott.moorlat@moorlat.ee http://www.moorlat.ee võõrkeeled: inglise, vene	<b>Toom PUNGAS</b>	<b>OÜ Synest</b> pk 977, 13402 Tallinn telefon: 660 9786 telefaks: 660 9787 e-post: toom@synest.ee võõrkeeled: inglise, saksa, soome, vene
<b>Anfia MORNA</b>	<b>Patendibüroo TURVAJA OÜ</b> Liivalaia 22, 10118 Tallinn telefon: 640 3109 telefaks: 640 3105 e-post: turvaja@turvaja.ee http://www.turvaja.ee võõrkeeled: inglise, vene	<b>Kaie PUUR</b>	<b>Patendibüroo RestMark OÜ</b> WTC Tallinn Ahtri 8 10151 Tallinn <b>Patendibüroo RestMark OÜ</b> Kompanii 1c 51004 Tartu telefon: 655 9803 telefaks: 747 7059 e-post: kaie.puur@restmark.ee http://www.restmark.ee võõrkeeled: inglise, vene, saksa
<b>Mari MUST</b>	<b>Raidla Lejins &amp; Norcous Advokaadibüroo OÜ</b> Roosikrantsi 2, 10119 Tallinn telefon: 640 7170 telefaks: 640 7171 e-post: mari.must@rln.ee http://www.rln.ee võõrkeeled: inglise, soome		

- Linnar PUUSEPP**      **OÜ LASVET**  
Suurtüki 4a, 10133 Tallinn  
pk 3136, 10505 Tallinn  
telefon: 640 6600  
telefaks: 640 6604  
e-post: lasvet@lasvet.ee  
http://www.lasvet.ee  
võõrkeeled: inglise, vene
- Harald TEHVER**      **Patendibüroo TURVAJA OÜ**  
Liivalaia 22  
10118 Tallinn  
telefon: 640 3109  
telefaks: 640 3105  
e-post: turvaja@turvaja.ee  
http://www.turvaja.ee  
võõrkeeled: inglise, saksa, vene
- Riina PÄRN**      **OÜ Intels**  
Magasini 12  
51005 Tartu  
telefon: 742 0401  
telefaks: 742 0326  
e-post: intels@intels.ee  
http://www.intels.ee  
võõrkeeled: inglise, vene
- Olga TREUFELDT**      **Patendibüroo TURVAJA OÜ**  
Liivalaia 22  
10118 Tallinn  
telefon: 640 3109  
telefaks: 640 3105  
e-post: turvaja@turvaja.ee  
http://www.turvaja.ee  
võõrkeeled: inglise, vene
- Tarmo ROSMAN**      **Rosman ja Partnerid OÜ**  
pk 652, 12602 Tallinn  
telefon: 656 1450  
telefaks: 656 1450  
e-post: tarman@cc.ttu.ee  
võõrkeeled: saksa, inglise, ungari,  
vene
- Enn URGAS**      **Patendibüroo TURVAJA OÜ**  
Liivalaia 22  
10118 Tallinn  
telefon: 640 3109  
telefaks: 640 3105  
e-post: turvaja@turvaja.ee  
http://www.turvaja.ee  
võõrkeeled: inglise, vene
- Arvo SALUMÄE**      **OÜ Amende Patendibüroo**  
Raua 65  
10152 Tallinn  
telefon: 648 6125  
telefaks: 641 0174  
e-post: amende@hot.ee  
võõrkeeled: inglise, saksa, soome,  
vene
- Juta-Maris UUSTALU**      **OÜ Amende Patendibüroo**  
Raua 65  
10152 Tallinn  
telefon: 648 6125  
telefaks: 641 0174  
e-post: amende@hot.ee  
võõrkeeled: inglise, vene
- Almar SEHVER**      **AAA Patendibüroo OÜ**  
Tartu mnt 16  
10117 Tallinn  
pk 3926, 10509 Tallinn  
telefon: 660 5910, 660 5911  
telefaks: 660 5912  
e-post: aaa@aaa.ee  
http://www.aaa.ee  
võõrkeeled: inglise, vene

**LIST OF PATENT ATTORNEYS, REGISTERED IN  
THE ESTONIAN STATE REGISTER OF PATENT ATTORNEYS**  
(by 4 June 2009)

Register is established on September 1<sup>st</sup> 2001

**FIELD OF ACTIVITY: TRADEMARKS, INDUSTRIAL DESIGNS AND GEOGRAPHICAL INDICATIONS**

<b>Arno ANIJALG</b>	<b>USTERVALL Ltd.</b> Kivi 21-6 51009 Tartu, Estonia P.O. Box 21 51002 Tartu, Estonia Phone: +372 744 1980 Fax: +372 744 1785 E-mail: anijalg@ustervall.ee Http://www.ustervall.ee German, Russian, Estonian	<b>Juhan HÄMMALOV</b>	<b>Intels Ltd.</b> Magasini 12 51005 Tartu, Estonia Phone: +372 742 0401 Fax: +372 742 0326 E-mail: intels@intels.ee Http://www.intels.ee English, German, Russian, Estonian
<b>Aivo ARULA</b>	<b>Patent Agency Käosaar &amp; Co</b> Tähe Str. 94 50107 Tartu, Estonia Phone: +372 738 3051 Fax: +372 738 3055 E-mail: info@kaosaar.ee Http://www.kaosaar.ee English, Russian, Estonian	<b>Uno JÄÄGER</b>	<b>Inseneribüroo Uneko Ltd.</b> Rüütli 51a 80010 Pärnu, Estonia Phone: +372 447 1021 Fax: +372 447 1001 GSM: +372 515 1844 E-mail: info@uneko.ee Http://www.uneko.ee English, Finnish, Russian, Estonian
<b>Martina BÖCKLER-LORVI</b>	<b>Lasvet Ltd.</b> P.O. Box 3136 10505 Tallinn, Estonia Phone: +372 640 6600 Fax: +372 640 6604 E-mail: lasvet@lasvet.ee Http://www.lasvet.ee English, Finnish, Estonian	<b>Sirje KAHU</b>	<b>USTERVALL Ltd.</b> Kivi 21-6 51009 Tartu, Estonia P.O. Box 21 51002 Tartu, Estonia Phone: +372 744 1980 Fax: +372 744 1785 E-mail: skahu@ustervall.ee Http://www.ustervall.ee English, Russian, Estonian
<b>Indrek EELMETS</b>	Sorainen Law Office Pärnu Road 15 10141 Tallinn, Estonia Phone: +372 640 0900 Fax: +372 640 0901 E-mail: sorainen@sorainen.ee Http://www.sorainen.com English, Russian, Finnish, Estonian	<b>Lembit KALEV</b>	<b>Patent Bureau ROOSILLA Ltd.</b> Järveotsa Road 39-61 13520 Tallinn, Estonia Phone: +372 657 1722 +372 657 5381 Fax: +372 657 5381 GSM: +372 511 9951 E-mail: roosilla@roosilla.ee Http://www.roosilla.ee English, Russian, Estonian
<b>Alla HÄMMALOV</b>	<b>Intels Ltd.</b> Magasini 12 51005 Tartu, Estonia Phone: +372 742 0401 Fax: +372 742 0326 E-mail: intels@intels.ee Http://www.intels.ee English, Polish, Russian, Estonian	<b>Anneli KANG</b>	<b>Synest Ltd.</b> P.O. Box 977 13402 Tallinn, Estonia Phone: +372 660 9786 Fax: +372 660 9787 E-mail: anneli@synest.ee English, German, Russian, French, Finnish, Swedish, Estonian

- Urmast KAULER**      **Patendibüroo TURVAJA OÜ**  
Liivalaia 22  
10118 Tallinn, Estonia  
Phone: +372 640 3109  
Fax: +372 640 3105  
E-mail: turvaja@turvaja.ee  
Http://www.turvaja.ee  
English, Russian, Finnish,  
Estonian
- Urmast KERNU**      **AAA Legal Services**  
Tartu Road 16  
10117 Tallinn, Estonia  
P.O. Box 3926  
10509 Tallinn, Estonia  
Phone: +372 660 5910  
+372 660 5911  
Fax: +372 660 5912  
E-mail: aaa@aaa.ee  
Http://www.aaa.ee  
English, German, Finnish,  
Russian, Estonian
- Ljubov KESSELMAN**      **Kesna Ltd.**  
Tedre Str. 77-52  
10616 Tallinn, Estonia  
Phone: +372 660 8068  
Fax: +372 660 8069  
E-mail: kesna@kesna.ee  
Http://www.kesna.ee  
English, Russian, Estonian
- Marina KESSELMAN**      **Kesna Ltd.**  
Tedre Str. 77-52  
10616 Tallinn, Estonia  
Phone: +372 660 8068  
Fax: +372 660 8069  
E-mail: kesna@kesna.ee  
Http://www.kesna.ee  
English, German, Russian,  
Estonian
- Heinu KOITEL**      **Patent & Trademark Agency  
Koitel**  
Tartu Road 65  
10115 Tallinn, Estonia  
P.O. Box 1759  
10902 Tallinn, Estonia  
Phone: +372 603 3260  
Fax: +372 603 3261  
E-mail: koitel@koitel.ee  
Http://www.koitel.ee  
English, Finnish, Russian,  
Estonian
- Raivo KOITEL**      **Patent & Trademark Agency  
Koitel**  
Tartu Road 65  
10115 Tallinn, Estonia  
P.O. Box 1759  
10902 Tallinn, Estonia  
Phone: +372 603 3260  
Fax: +372 603 3261  
E-mail: koitel@koitel.ee  
Http://www.koitel.ee  
English, Finnish, Russian,  
Estonian
- Katrin  
KOITEL-VEIDIK**      **Patent & Trademark Agency  
Koitel**  
Tartu Road 65  
10115 Tallinn, Estonia  
P.O. Box 1759  
10902 Tallinn, Estonia  
Phone: +372 603 3260  
Fax: +372 603 3261  
E-mail: koitel@koitel.ee  
Http://www.koitel.ee  
English, Finnish, Estonian
- Mart Enn KOPPEL**      **Patent Bureau Koppel**  
Kajaka 4-10  
11317 Tallinn, Estonia  
Phone: +372 677 4136  
Fax: +372 677 4138  
E-mail: info@koppelpb.com  
Http://www.koppelpb.com  
English, Russian, Finnish,  
Estonian
- Heinrich KRUPP**      **Patendibüroo TURVAJA OÜ**  
Liivalaia 22  
10118 Tallinn, Estonia  
Phone: +372 640 3109  
Fax: +372 640 3105  
E-mail: turvaja@turvaja.ee  
Http://www.turvaja.ee  
German, Russian, Estonian
- Jüri KÄOSAAR**      **Patent Agency Käosaar & Co**  
Tähe Str. 94  
50107 Tartu, Estonia  
Phone: +372 738 3051  
Fax: +372 738 3055  
E-mail: info@kaosaar.ee  
Http://www.kaosaar.ee  
English, Russian, Estonian
- Kalev KÄOSAAR**      **Patent Agency Käosaar & Co**  
Suur-Patarei 2  
10415 Tallinn, Estonia  
Phone: +372 637 9484  
Fax: +372 637 9485  
E-mail:  
kalev.kaosaar@kaosaar.ee  
Http://www.kaosaar.ee  
English, Russian, Estonian

<b>Kristjan LEPPIK</b>	<b>Patendibüroo TURVAJA OÜ</b> Liivalaia 22 10118 Tallinn, Estonia Phone: +372 640 3109 Fax: +372 640 3105 E-mail: turvaja@turvaja.ee Http://www.turvaja.ee English, Russian, Estonian	<b>Anfia MORNA</b>	<b>Patendibüroo TURVAJA OÜ</b> Liivalaia 22 10118 Tallinn, Estonia Phone: +372 640 3109 Fax: +372 640 3105 E-mail: turvaja@turvaja.ee Http://www.turvaja.ee English, Russian, Estonian
<b>Reet MAASIKAMÄE</b>	<b>Patent Bureau Kaitsepurus Ltd.</b> Mulla Str. 4-3 10611 Tallinn, Estonia Phone: +372 673 9097 +372 633 2798 Fax: +372 677 4844 E-mail: purus@hot.ee kaitsepurus@hot.ee Http://www.hot.ee/purus/ English, Russian, Estonian	<b>Mari MUST</b>	<b>Raidla Lejins &amp; Norcoux Advokaadibüroo OÜ</b> Roosikrantsi 2 10119 Tallinn, Estonia Phone: +372 640 7170 Fax: +372 640 7171 E-mail: mari.must@rln.ee Http://www.rln.ee English, Finnish, Estonian
<b>Raivo MATSOO</b>	<b>RM Hirvela Patent Bureau Ltd</b> Saku 15, 11314 Tallinn, Estonia Phone: +372 614 0816 Fax: +372 614 0818 E-mail: hirvela@hirvela.ee English, Russian, Estonian	<b>Tõnu NELSAS</b>	<b>AAA Legal Services</b> Tartu Road 16 10117 Tallinn, Estonia P.O. Box 3926 10509 Tallinn, Estonia Phone: +372 660 5910 +372 660 5911 Fax: +372 660 5912 E-mail: aaa@aaa.ee Http://www.aaa.ee English, Russian, Finnish, Estonian
<b>Elle MELLIK</b>	<b>AAA Legal Services</b> Tartu Road 16 10117 Tallinn, Estonia P.O. Box 3926 10509 Tallinn, Estonia Phone: +372 660 5910 +372 660 5911 Fax: +372 660 5912 E-mail: aaa@aaa.ee Http://www.aaa.ee English, Russian, Estonian	<b>Jüri OLT</b>	<b>Danteks OÜ</b> Tiigi 6 51003 Tartu, Estonia Phone: +372 508 1671 Fax: +372 730 2844 E-mail: jyri@danteks.net Http://www.danteks.net English, German, Finnish, Russian, Estonian
<b>Lembit MITT</b>	<b>AAA Legal Services</b> Tartu Road 16 10117 Tallinn, Estonia P.O. Box 3926 10509 Tallinn, Estonia Phone: +372 660 5910 +372 660 5911 Fax: +372 660 5912 E-mail: aaa@aaa.ee Http://www.aaa.ee English, Russian, Estonian	<b>Jaak OSTRAT</b>	<b>Lasvet Ltd.</b> P.O. Box 3136 10505 Tallinn, Estonia Phone: +372 640 6600 Fax: +372 640 6604 E-mail: lasvet@lasvet.ee Http://www.lasvet.ee English, German, Finnish, Russian, Estonian
<b>Ott MOORLAT</b>	<b>Moorlat &amp; Co Ltd. Patent Bureau</b> P.O. Box 723 12902 Tallinn, Estonia Phone: +372 655 0450 +372 654 2844 Fax: +372 654 2844 E-mail: ott.moorlat@moorlat.ee Http://www.moorlat.ee English, Russian, Estonian	<b>Villu PAVELTS</b>	<b>Lasvet Ltd.</b> P.O. Box 3136 10505 Tallinn, Estonia Phone: +372 640 6600 Fax: +372 640 6604 E-mail: lasvet@lasvet.ee Http://www.lasvet.ee English, Finnish, Russian, Estonian

- Toom PUNGAS**      **Synest Ltd.**  
P.O. Box 977  
13402 Tallinn, Estonia  
Phone: +372 660 9786  
Fax: +372 660 9787  
E-mail: toom@synest.ee  
English, German, Finnish,  
Russian, Estonian
- Kaie PUUR**      **Patendibüroo RestMark OÜ**  
WTC Tallinn  
Ahtri 8  
10151 Tallinn, Estonia  
**Patendibüroo RestMark OÜ**  
Kompanii 1c  
51004 Tartu, Estonia  
Phone: +372 655 9803  
Fax: +372 747 7059  
E-mail: kaie.puur@restmark.ee  
Http://www.restmark.ee  
English, Russian, German,  
Estonian
- Linnar PUUSEPP**      **Lasvet Ltd.**  
P.O. Box 3136  
10505 Tallinn, Estonia  
Phone: +372 640 6600  
Fax: +372 640 6604  
E-mail: lasvet@lasvet.ee  
Http://www.lasvet.ee  
English, Russian, Estonian
- Riina PÄRN**      **Intels Ltd.**  
Magasini 12  
51005 Tartu, Estonia  
Phone: +372 742 0401  
Fax: +372 742 0326  
E-mail: intels@intels.ee  
Http://www.intels.ee  
English, Russian, Estonian
- Tarmo ROSMAN**      **Rosman and Partners Ltd.**  
P.O. Box 652  
12602 Tallinn, Estonia  
Phone: +372 656 1450  
Fax: +372 656 1450  
E-mail: tarman@cc.ttu.ee  
German, English, Hungarian,  
Russian, Estonian
- Arvo SALUMÄE**      **AMENDE Patent Agency Ltd.**  
Raua 65, 10152 Tallinn, Estonia  
Phone: +372 648 6125  
Fax: +372 641 0174  
E-mail: amende@hot.ee  
English, German, Finnish,  
Russian, Estonian
- Almar SEHVER**      **AAA Legal Services**  
Tartu Road 16  
10117 Tallinn, Estonia  
P.O. Box 3926  
10509 Tallinn, Estonia  
Phone: +372 660 5910  
+372 660 5911  
Fax: +372 660 5912  
E-mail: aaa@aaa.ee  
Http://www.aaa.ee  
English, Russian, Estonian
- Harald TEHVER**      **Patendibüroo TURVAJA OÜ**  
Liivalaia 22  
10118 Tallinn, Estonia  
Phone: +372 640 3109  
Fax: +372 640 3105  
E-mail: turvaja@turvaja.ee  
Http://www.turvaja.ee  
English, German, Russian,  
Estonian
- Olga TREUFELDT**      **Patendibüroo TURVAJA OÜ**  
Liivalaia 22  
10118 Tallinn, Estonia  
Phone: +372 640 3109  
Fax: +372 640 3105  
E-mail: turvaja@turvaja.ee  
Http://www.turvaja.ee  
English, Russian, Estonian
- Enn URGAS**      **Patendibüroo TURVAJA OÜ**  
Liivalaia 22  
10118 Tallinn, Estonia  
Phone: +372 640 3109  
Fax: +372 640 3105  
E-mail: turvaja@turvaja.ee  
Http://www.turvaja.ee  
English, Russian, Estonian
- Juta-Maris UUSTALU**      **AMENDE Patent Agency Ltd.**  
Raua 65, 10152 Tallinn, Estonia  
Phone: +372 648 6125  
Fax: +372 641 0174  
E-mail: amende@hot.ee  
English, Russian, Estonian