



ISSN 1406-376X

EESTI VABARIIK

A large, stylized graphic consisting of the letters 'T' and 'A' in a light blue, semi-transparent font, serving as a background for the title.

**T EESTI  
TÖÖSTUSDISAINI-  
LAHENDUSE LEHT**



PATENDIAMETI AMETLIK VÄLJAANNE

**1**  
**2009**  
TALLINN



ISSN 1406-376X

EESTI VABARIIK

**T** **EESTI**  
**TÖÖSTUSDISAINI-**  
**LAHENDUSE LEHT**

**PATENDIAMETI  
AMETLIK VÄLJAANNE**

**XII aastakäik**

**Käesolevas numbris  
esitatud andmed  
loetakse avaldatuks  
16. veebruaril 2009. a.**

**1**  
**2009**  
**VEEBRUAR  
TALLINN**

Eesti Tööstusdisainilahenduse Lehte antakse välja tööstusdisaini kaitse seaduse (jõustunud 11.01.1998) alusel.  
The Estonian Industrial Design Gazette is the official publication of the Estonian Patent Office.  
Published under Industrial Design Protection Law of the Republic of Estonia (coming into force 11 January 1998).  
Date of publication of the data presented in this issue - 16 February 2009.

Patendiameti  
infoosakond  
Toompuiestee 7  
15041 Tallinn  
Tel 627 7907  
Faks 627 7943  
E-post Info@epa.ee

The Information Department  
of the Estonian Patent Office  
Toompuiestee 7  
15041 Tallinn, ESTONIA  
Phone +372 627 7907  
Fax +372 627 7943  
E-mail Info@epa.ee

Levitaja

Eesti Patendiraamatukogu  
Olevimägi 8/10  
10123 Tallinn  
Tel 641 1248  
Faks 641 1018  
E-post patent@patentlib.ee

Distributor

Estonian Patent Library  
Olevimägi 8/10  
10123 Tallinn, ESTONIA  
Phone +372 641 1248  
Fax +372 641 1018  
E-mail patent@patentlib.ee

**SISUKORD**

Andmete identifitseerimise rahvusvahelised numberkoodid (INID-koodid) . . . . .	4
Riikide, teiste ühenduste ja valitsustevaheliste organisatsioonide koodid . . . . .	5
I. REGISTREERITUD TÖÖSTUSDISAINILAHENDUSED . . . . .	6
II. RAHVUSVAHELISELT REGISTREERITUD TÖÖSTUSDISAINILAHENDUSED . . . . .	16
III. MUUD REGISTRIKANDED . . . . .	32
Registreeringu kehtivuse pikendamine . . . . .	32
Tööstusdisainilahenduse üleminek . . . . .	32
Registreeringu jagamine . . . . .	-
Registreeringu andmete muudatused . . . . .	32
Registreeringu andmete parandused . . . . .	-
Tööstusdisainilahenduse litsentsimine . . . . .	-
Tööstusdisainilahenduse pantimine . . . . .	-
Tööstusdisainilahenduse tunnistuse duplikaadi väljaandmine . . . . .	-
Registreeringu kustutamine . . . . .	32
IV. LOENDID . . . . .	33
Registreeritud tööstusdisainilahenduste registreerimise taotluste numbriline loend . . . . .	33
Rahvusvaheliselt registreeritud tööstusdisainilahenduste numbriline loend . . . . .	33
V. TÖÖSTUSDISAINIALASED ÕIGUSAKTID JA MUU INFO . . . . .	34
Riiklikus patendivolinike registris registreeritud patendivolinike nimekiri . . . . .	34

**CONTENTS**

Internationally Agreed Numbers for the Identification of Data (INID Codes) . . . . .	4
List of Codes of States, Other Entities and Intergovernmental Organizations . . . . .	5
I. REGISTERED INDUSTRIAL DESIGNS . . . . .	6
II. INTERNATIONALLY REGISTERED INDUSTRIAL DESIGNS . . . . .	16
III. OTHER ENTRIES IN THE REGISTER . . . . .	32
Extension of the Registration . . . . .	32
Transfer of Industrial Design . . . . .	32
Division of the Registration. . . . .	-
Amendments to Registration Data . . . . .	32
Corrections to Registration Data . . . . .	-
Licensing of Industrial Design . . . . .	-
Pledging of Industrial Design . . . . .	-
Issue of a Copy of the Industrial Design Certificate . . . . .	-
Deletion of the Registration . . . . .	32
IV. LISTS . . . . .	33
Numerical List of Registration Applications of Registered Industrial Designs . . . . .	33
Numerical List of Internationally Registered Industrial Designs . . . . .	33
V. LEGAL ACTS AND INFORMATION CONCERNING INDUSTRIAL DESIGNS . . . . .	34
List of Patent Attorneys, Registered in the Estonian State Register of Patent Attorneys . . . . .	38

**ANDMETE IDENTIFITSEERIMISE  
RAHVUSVAHELISED NUMBERKOODID  
(INID-KOODID)  
WIPO Standard ST. 80**

**INTERNATIONALLY AGREED NUMBERS FOR  
THE IDENTIFICATION OF DATA  
(INID CODES)  
WIPO Standard ST. 80**

(11) Registreeringu number	(11) Number of the Registration
(15) Registreerimise kuupäev	(15) Date of the Registration
(18) Registreeringu kehtivuse lõppemise kuupäev	(18) Expected expiration date of the registration
(21) Registreerimistaotluse number	(21) Application Number
(22) Registreerimistaotluse esitamise kuupäev	(22) Application Filing Date
(24) Registreeringu kehtivuse alguse kuupäev	(24) Date from which the Industrial Design right has effected
(28) Variantide arv	(28) Number of Industrial Designs included in the application
(30) Prioriteet	(30) Priority
(51) Rahvusvahelise klassifikatsiooni klassi ja alaklassi number	(51) International Classification for Industrial Designs (class and subclass of the Locarno Classification)
(54) Tööstusdisainilahenduse nimetus	(54) Title of the Industrial Design
(55) Tööstusdisainilahenduse reproduktsioon	(55) Reproduction of the Industrial Design
(72) Tööstusdisainilahenduse autor(id)	(72) Author(s) of Industrial Design
(73) Tööstusdisainilahenduse omanik(ud)	(73) Proprietor(s) of Industrial Design
(74) Patendivolinik või ühine esindaja	(74) Patent Attorney or Common Representative

**RIIKIDE, TEISTE ÜHENDUSTE JA VALITSUSTEVAAHELISTE  
ORGANISATSIOONIDE KOODID**

AD	Andorra	DZ	Alžeeria	JM	Jamaica	PW	Belau
AE	Araabia	EA	Euraasia	JO	Jordania	PY	Paraguay
	Ühendemiraadid		Patendiorganisat-	JP	Jaapan	QA	Katar
AF	Afganistan		sioon (EAPO)	KE	Kenya	RO	Rumeenia
AG	Antigua ja Barbuda	EC	Ecuador	KG	Kõrgõzstan	RS	Serbia
AI	Anguilla	EE	Eesti	KH	Kambodža	RU	Venemaa
AL	Albaania	EG	Egiptus	KI	Kiribati	RW	Rwanda
AM	Armeenia	EH	Lääne-Sahara	KM	Komoorid	SA	Saudi Araabia
AN	Hollandi Antillid	EM	Siseturu	KN	Saint Kitts ja Nevis	SB	Saalomoni Saared
AO	Angola		Ühtlustamise	KP	Põhja-Korea	SC	Seišellid
AP	Aafrika Regionaalne		Amet (kaubamärgid	KR	Lõuna-Korea	SD	Sudaan
	Tööstusomandi Orga-		ja tööstusdisaini-	KW	Kuveit	SE	Rootsi
	nisatsioon (ARIPO)		lahendused) (OHIM)	KY	Kaimanisaared	SG	Singapur
AR	Argentina	EP	Euroopa	KZ	Kasahstan	SH	Saint Helena
AS	Ameerika Samoa		Patendiamet (EPO)	LA	Laos	SI	Sloveenia
AT	Austria	ER	Eritrea	LB	Liibanon	SK	Slovakkia
AU	Austraalia	ES	Hispaania	LC	Saint Lucia	SL	Sierra Leone
AW	Aruba	ET	Etiopia	LI	Liechtenstein	SM	San Marino
AZ	Aserbaidžaan	FI	Soome	LK	Sri Lanka	SN	Senegal
BA	Bosnia ja	FJ	Fidži	LR	Libeeria	SO	Somaalia
	Hertsegoviina	FK	Falklandi (Malviini)	LS	Lesotho	SR	Suriname
BB	Barbados		saared	LT	Leedu	ST	São Tomé ja Príncipe
BD	Bangladesh	FM	Mikroneesia	LU	Luksemburg	SV	El Salvador
BE	Belgia	FO	Fääri saared	LV	Läti	SY	Süüria
BF	Burkina Faso	FR	Prantsusmaa	LY	Liibüa	SZ	Svaasimaa
BG	Bulgaaria	GA	Gabon	MA	Maroko	TC	Turks ja Caicos
BH	Bahrein	GB	Ühendkuningriik	MC	Monaco	TD	Tšaad
BI	Burundi		(Suurbritannia)	MD	Moldova	TG	Togo
BJ	Benin	GC	Pärsia Lahe	ME	Montenegro	TH	Tai
BM	Bermuda		Koostööõnukogu	MG	Madagaskar	TJ	Tadžikistan
BN	Brunei	GD	Grenada	MH	Marshalli Saared	TM	Türkmenistan
BO	Boliivia	GE	Gruusia	MK	Makedoonia	TN	Tuneesia
BR	Brasiilia	GG	Guernsey	ML	Mali	TO	Tonga
BS	Bahama	GH	Ghana	MM	Myanmar (Birma)	TL	Ida-Timor
BT	Bhutan	GI	Gibraltar	MN	Mongoolia	TR	Türgi
BV	Bouvet' saar	GL	Gröönimaa	MO	Macao	TT	Trinidad ja Tobago
BW	Botswana	GM	Gambia	MP	Põhja-Mariaanid	TV	Tuvalu
BX	Beneluxi	GN	Guinea	MR	Mauritaania	TW	Taiwan (Hiina provints)
	Kaubamärgiamet	GQ	Ekvatoriaal-Guinea	MS	Montserrat	TZ	Tansaania
	(BBM) ja Beneluxi	GR	Kreeka	MT	Malta	UA	Ukraina
	Tööstusdisainilahen-	GS	Lõuna-Georgia ja	MU	Mauritius	UG	Uganda
	duste Amet (BBDM)		Lõuna-Sandwichi	MV	Maldiiivid	US	Ameerika
BY	Valgevene		saared	MW	Malawi		Ühendriigid
BZ	Belize	GT	Guatemala	MX	Mehhiko	UY	Uruguay
CA	Kanada	GW	Guinea-Bissau	MY	Malaisia	UZ	Usbekistan
CF	Kesk-Aafrika	GY	Guyana	MZ	Mosambiik	VA	Vatikan (Püha Tool)
	Vabariik	HK	Hongkong	NA	Namiibia	VC	Saint Vincent ja
CG	Kongo	HN	Honduras	NE	Niger		Grenadiinid
CH	Šveits	HR	Horvaatia	NG	Nigeeria	VE	Venezuela
CI	Côte d'Ivoire	HT	Haiti	NI	Nicaragua	VG	Neitsisaared
CK	Cooki saared	HU	Ungari	NL	Holland	VN	Vietnam
CL	Tšiili	IB	Ülemaailmse	NO	Norra	VU	Vanuatu
CM	Kamerun		Intellektuaalomandi	NP	Nepal	WO	Ülemaailmne
CN	Hiina		Organisatsiooni	NR	Nauru		Intellektuaalomandi
CO	Kolumbia		(WIPO) Rahvus-	NZ	Uus-Meremaa		Organisatsioon
CR	Costa Rica		vaheline Büroo	OA	Aafrika Intellektuaal-		(WIPO) (Rahvus-
CU	Kuuba	ID	Indoneesia		omandi Organisat-		vaheline Büroo)
CV	Cabo Verde	IE	Iiri		sioon (OAPI)	WS	Samoa
CY	Küpros	IL	Iisrael	OM	Omaan	YE	Jeemen
CZ	Tšehhi	IM	Man'i saar	PA	Panama	ZA	Lõuna-Aafrika Vabariik
DE	Saksamaa	IN	India	PE	Peruu	ZM	Sambia
DJ	Djibouti	IQ	Iraak	PG	Paapua Uus-Guinea	ZR	Zaire
DK	Taani	IR	Iraan	PH	Filipiinid	ZW	Zimbabwe
DM	Dominica	IS	Island	PK	Pakistan		
DO	Dominikaani	IT	Itaalia	PL	Poola		
	Vabariik	JE	Jersey	PT	Portugal		

## **I. REGISTREERITUD TÖÖSTUSDISAINILAHENDUSED**

Avaldatakse "Tööstusdisaini kaitse seaduse" § 55<sup>1</sup> lõike 7 alusel.

Patendiamet ei ole kontrollinud tööstusdisainilahenduse uudsust ja eristatavust tulenevalt "Tööstusdisaini kaitse seaduse" § 31 lõike 2 punktist 1.

- (11) **Registreeringu number** **01492** (51) Klass: **25-03**
- (21) **Taotluse number** D200800035
- (15) **Registreerimise päev** 16.02.2009
- (22) **Esitamise päev** 15.05.2008
- (24) **Registreeringu kehtivuse alguse päev** 15.05.2008
- (18) **Registreeringu kehtivuse lõppemise päev** 15.05.2013
- (28) **Variantide arv** 2
- (72) **Autor** Peeter Kivioja, Nilbö küla, Rõuge vald, 66262 Võru maakond, EE
- (73) **Omanik** Peeter Kivioja, Nilbö küla, Rõuge vald, 66262 Võru maakond, EE

(54) **Nimetus** **Lahtine grillmaja**

(55) **Reproduktsoon**

01492-1



01492-2





(11) **Registreeringu number** **01493**

(51) Klass: **10-03**

(21) **Taotluse number** D200800081

(15) **Registreerimise päev** 16.02.2009

(22) **Esitamise päev** 30.07.2008

(24) **Registreeringu kehtivuse alguse päev** 30.07.2008

(18) **Registreeringu kehtivuse lõppemise päev** 30.07.2013

(28) **Variantide arv** 1

(72) **Autor** Maarja Lilover, Liivaoja 12-40, 10155 Tallinn, EE

(73) **Omanik** Maarja Lilover, Liivaoja 12-40, 10155 Tallinn, EE

(54) **Nimetus** **Parkimiskell**

(55) **Reproduktsoon**

01493-1

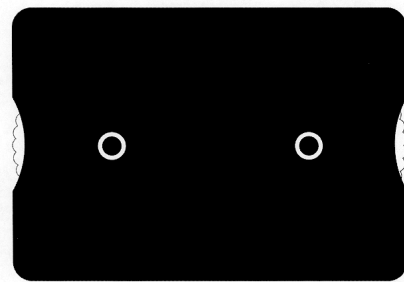
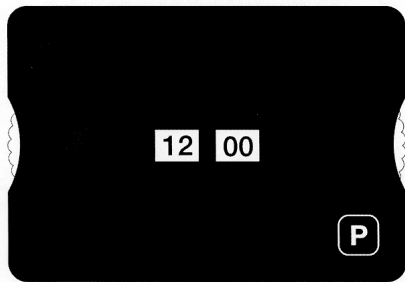

(11) Registreeringu number	<b>01494</b>	(51) Klass: <b>02-04</b>
(21) Taotluse number	D200800084	
(15) Registreerimise päev	16.02.2009	
(22) Esitamise päev	19.09.2008	
(24) Registreeringu kehtivuse alguse päev	19.09.2008	
(18) Registreeringu kehtivuse lõppemise päev	19.09.2013	
(28) Variantide arv	1	
(72) Autor	Pille Praks, Lumemarja tee 59, Viimsi, 74001 Harju maakond, EE	
(73) Omanik	Pille Praks, Lumemarja tee 59, Viimsi, 74001 Harju maakond, EE	

(54) Nimetus **Sokid**

(55) Reproduktsoon

01494-1



(11) Registreeringu number	<b>01495</b>	(51) Klass: <b>09-03</b>
(21) Taotluse number	D200800085	
(15) Registreerimise päev	16.02.2009	
(22) Esitamise päev	09.10.2008	
(24) Registreeringu kehtivuse alguse päev	09.10.2008	
(18) Registreeringu kehtivuse lõppemise päev	09.10.2013	
(28) Variantide arv	1	
(72) Autor	Jüri Soo, Oja 35-33, Pärnu, 80038 Pärnu maakond, EE	
(73) Omanik	Jüri Soo, Oja 35-33, Pärnu, 80038 Pärnu maakond, EE	

(54) Nimetus **Pakend**

(55) Reproduktsoon

01495-1



(11) Registreeringu number	<b>01496</b>
(21) Taotluse number	D200800087
(15) Registreerimise päev	16.02.2009
(22) Esitamise päev	10.10.2008
(24) Registreeringu kehtivuse alguse päev	10.10.2008
(18) Registreeringu kehtivuse lõppemise päev	10.10.2013
(28) Variantide arv	1
(72) Autor	Enn Praks, Kalevi 109B-3, 50104 Tartu, EE
(73) Omanik	Enn Praks, Kalevi 109B-3, 50104 Tartu, EE
(74) Patendivolinik või ühine esindaja	Lembit Mitt

(51) Klass: **12-16**(54) Nimetus **Velg**

(55) Reproduktsoon

01496-1



(11) Registreeringu number	<b>01497</b>	(51) Klass: <b>06-01</b>
(21) Taotluse number	D200800088	
(15) Registreerimise päev	16.02.2009	
(22) Esitamise päev	27.10.2008	
(24) Registreeringu kehtivuse alguse päev	27.10.2008	
(18) Registreeringu kehtivuse lõppemise päev	27.10.2013	
(28) Variantide arv	1	
(72) Autor	Tarmo Luisk, Tulika 14-7, 10613 Tallinn, EE	
(73) Omanik	2 Pea OÜ, Vääna küla, Harku vald, 76903 Harju maakond, EE	
(74) Patendivolinik või ühine esindaja	Jaak Ostrat	

(54) Nimetus **Pink**

(55) Reproduktsoon

01497-1

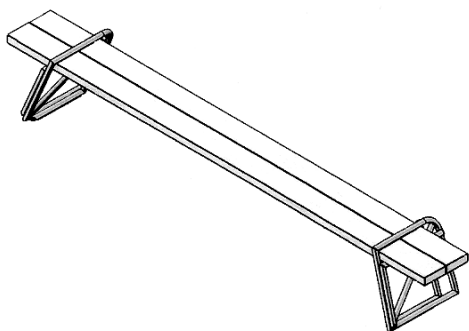

- (11) **Registreeringu number** **01498** (51) Klass: **19-08**
- (21) **Taotluse number** D200800090
- (15) **Registreerimise päev** 16.02.2009
- (22) **Esitamise päev** 14.11.2008
- (24) **Registreeringu kehtivuse alguse päev** 14.11.2008
- (18) **Registreeringu kehtivuse lõppemise päev** 14.11.2013
- (28) **Variantide arv** 1
- (72) **Autor** Kaili-Lotta Juhkam, Tuulemaa 21-34, 10311 Tallinn, EE
- (73) **Omanik** Kaili-Lotta Juhkam, Tuulemaa 21-34, 10311 Tallinn, EE
- (54) **Nimetus** **Kujutis**
- (55) **Reproduktsoon**
- 01498-1



- (11) **Registreeringu number** **01499** (51) Klass: **19-08**
- (21) **Taotluse number** D200800091
- (15) **Registreerimise päev** 16.02.2009
- (22) **Esitamise päev** 14.11.2008
- (24) **Registreeringu kehtivuse alguse päev** 14.11.2008
- (18) **Registreeringu kehtivuse lõppemise päev** 14.11.2013
- (28) **Variantide arv** 1
- (72) **Autor** Kaili-Lotta Juhkam, Tuulemaa 21-34, 10311 Tallinn, EE
- (73) **Omanik** Kaili-Lotta Juhkam, Tuulemaa 21-34, 10311 Tallinn, EE
- (54) **Nimetus** **Kujutis**
- (55) **Reproduktsoon**

01499-1



- (11) **Registreeringu number** **01500** (51) Klass: **14-02**
- (21) **Taotluse number** D200800092
- (15) **Registreerimise päev** 16.02.2009
- (22) **Esitamise päev** 21.11.2008
- (24) **Registreeringu kehtivuse alguse päev** 21.11.2008
- (18) **Registreeringu kehtivuse lõppemise päev** 21.11.2013
- (28) **Variantide arv** 1
- (72) **Autor** Tiit Liiv, Akadeemia tee 23A, 12618 Tallinn, EE  
Gustav Poola, Akadeemia tee 23A, 12618 Tallinn, EE  
Kaido Kevvai, Akadeemia tee 23A, 12618 Tallinn, EE
- (73) **Omanik** ARTEC GROUP OÜ, Järvevana tee 9, 11314 Tallinn, EE
- (74) **Patendivolinik või ühine esindaja** Ott Moorlat
- (54) **Nimetus** **Mobiilne andmetöölusseade**
- (55) **Reproduktsoon**

01500-1





## **II. RAHVUSVAHELISELT REGISTREERITUD TÖÖSTUSDISAINILAHENDUSED**

Avaldatakse "Tööstusdisaini kaitse seaduse" § 87<sup>4</sup> lõike 3 alusel. Patendiamet ei ole kontrollinud tööstusdisainilahenduse uudsust ja eristatavust tulenevalt "Tööstusdisaini kaitse seaduse" § 31 lõike 2 punktist 1.

(11) **Rahvusvah reg nr****DM/069502**(51) Klass: **10-07**(21) **Rahvusvah reg jrk**

H200800010

(15) **Registreeringu päev**

15.11.2007

(22) **Esitamise päev**

15.10.2007

(28) **Variantide arv**

1

(30) **Prioriteediandmed**

133 909, 17.04.2007, CH

(72) **Autor**

Rodolphe Cattin

(73) **Omanik**DENT & CO. AG (DENT & CO. SA)(DENT & CO. LTD),  
Zugerstrasse 77, CH-6340 Baar, CH**WIPO Rahvusvah Tööstusdisainilahenduste****Bülletääni nr, kus registreering on avaldatud** 2008/04(55) **Reproduksioon**

DM/069502-1

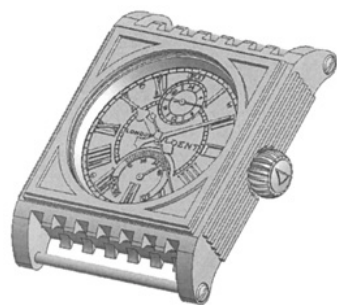
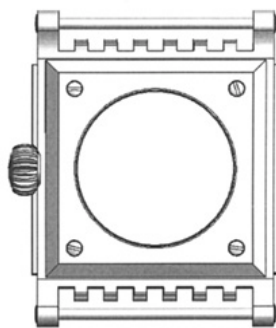
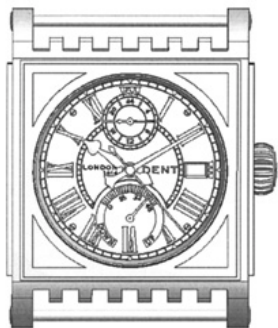

(11) **Rahvusvah reg nr****DM/069532**(51) Klass: **10-07**(21) **Rahvusvah reg jrk**

H200800013

(15) **Registreeringu päev**

12.12.2007

(22) **Esitamise päev**

28.09.2007

(28) **Variantide arv**

1

(72) **Autor**

Florian Strasser

(73) **Omanik**

MGI LUXURY GROUP S.A., Rue de Nidau 35, CH-2502 Biel/Bienne, CH

**WIPO Rahvusvah Tööstusdisainilahenduste****Bülletääni nr, kus registreering on avaldatud** 2008/05(55) **Reproduktsoon**

DM/069532-1

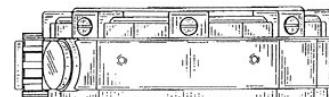
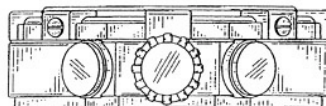
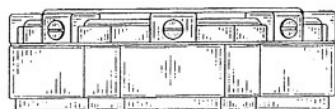
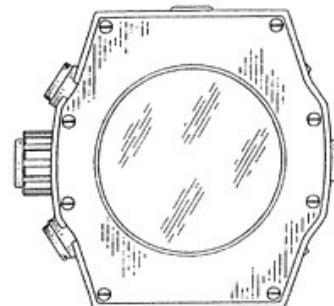
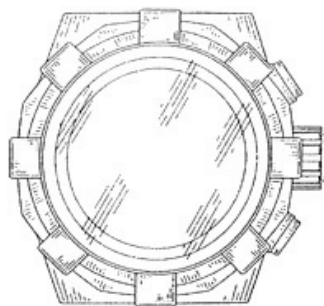
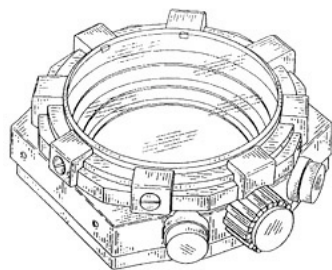

(11) **Rahvusvah reg nr** DM/069554

(51) Klass: **08-05**

(21) **Rahvusvah reg jrk** H200800014

(15) **Registreeringu päev** 07.12.2007

(22) **Esitamise päev** 26.11.2007

(28) **Variantide arv** 1

(72) **Autor** *Autori andmeid ei avalikustata*

(73) **Omanik** ROTHENBERGER, S.A., Carretera Durango-Elorrio, Km. 2,  
E-48220 ABADIANO (Vizcaya), ES

**WIPO Rahvusvah Tööstusdisainilahenduste**  
**Bülletääni nr, kus registreering on avaldatud** 2008/05

(55) **Reproduksioon**

DM/069554-1

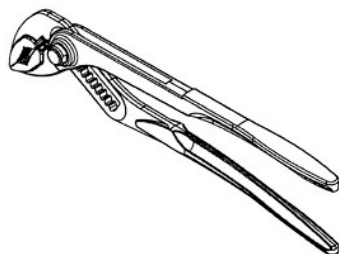
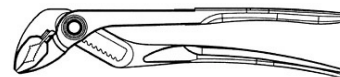
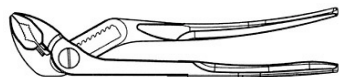

(11) **Rahvusvah reg nr**

**DM/069600**

(51) Klass: **09-01**

(21) **Rahvusvah reg jrk**

H200800035

(15) **Registreeringu päev**

16.10.2007

(28) **Variantide arv**

1

(72) **Autor**

Monika Marie-Anna Steinmetz

(73) **Omanik**

Monika Marie-Anna Steinmetz, c/o G. Saugy, Chemin du Clos 14,  
CH-1296 Coppet, CH

**WIPO Rahvusvah Tööstusdisainilahenduste  
Bülletääni nr, kus registreering on avaldatud**

2008/9

(55) **Reproduksioon**

DM/069600-1

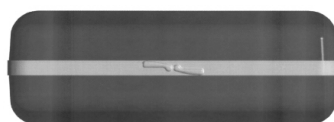
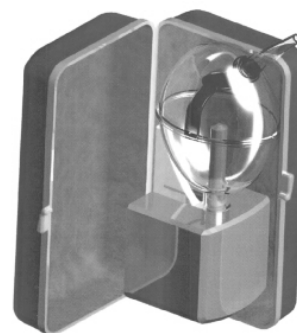

(11) <b>Rahvusvah reg nr</b>	<b>DM/069676</b>	(51) <b>Klass: 13-02</b>
(21) <b>Rahvusvah reg jrk</b>	H200800007	
(15) <b>Registreeringu päev</b>	22.01.2008	
(28) <b>Variantide arv</b>	3	
(30) <b>Prioriteediandmed</b>	000 762 232, 23.07.2007, EM	
(72) <b>Autor</b>	Hans-Peter Asslinger	
(73) <b>Omanik</b>	Johnson Controls Hybrid & Recycling GmbH, Am Leineufer 51, Hannover, 30419, DE	
<b>WIPO Rahvusvah Tööstusdisainilahenduste Bülletääni nr, kus registreering on avaldatud</b>	2008/03	

(55) **Reproduktsoon**

DM/069676-1



DM/069676-2



DM/069676-3



(11) **Rahvusvah reg nr**

**DM/069942**

(51) **Klass: 10-07**

(21) **Rahvusvah reg jrk**

H200800034

(15) **Registreeringu päev**

02.04.2008

(28) **Variante arv**

1

(72) **Autor**

Patrick Joseph Lassigne

(73) **Omanik**

Patrick Joseph Lassigne, Sur les Roches 17, CH-1358 Portalban, CH

**WIPO Rahvusvah Tööstusdisainilahenduste**

**Bülletääni nr, kus registreering on avaldatud** 2008/9

(55) **Reproduksioon**

DM/069942-1

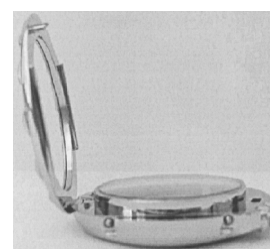
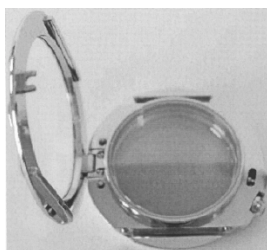
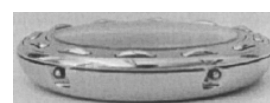
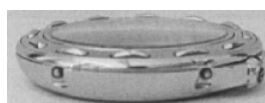



(11) <b>Rahvusvah reg nr</b>	<b>DM/070031</b>	(51) <b>Klass: 07-05</b>
(21) <b>Rahvusvah reg jrk</b>	H200800011	
(15) <b>Registreeringu päev</b>	09.01.2008	
(28) <b>Variantide arv</b>	1	
(30) <b>Prioriteediandmed</b>	D0700170, 16.11.2007, HU	
(72) <b>Autor</b>	István Botos Ivanka Botos	
(73) <b>Omanik</b>	ISTVÁN BOTOS, Váralja u. 55, H-7800 Siklós, HU IVANKA BOTOS, Váralja u. 55, H-7800 Siklós, HU	
<b>WIPO Rahvusvah Tööstusdisainilahenduste Bülletääni nr, kus registreering on avaldatud</b>	2008/04	

(55) **Reproduksioon**

DM/070031-1

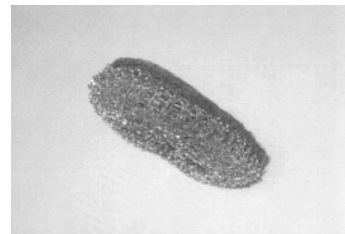
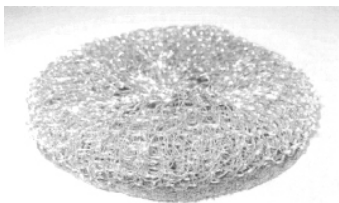
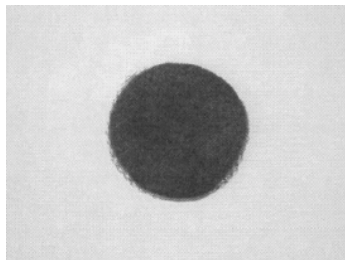

(11) <b>Rahvusvah reg nr</b>	<b>DM/070035</b>	(51) <b>Klass: 14-03</b>
(21) <b>Rahvusvah reg jrk</b>	H200800012	
(15) <b>Registreeringu päev</b>	17.03.2008	
(28) <b>Variantide arv</b>	1	
(30) <b>Prioriteediandmed</b>	000790589, 17.09.2007, EM	
(72) <b>Autor</b>	Pinja Okkonen	
(73) <b>Omanik</b>	NOKIA CORPORATION, Keilalahdentie 4, FIN-02150 Espoo, FI	
<b>WIPO Rahvusvah Tööstusdisainilahenduste</b>		
<b>Bülletääni nr, kus registreering on avaldatud</b>	2008/04	

(55) **Reproduksioon**

DM/070035-1

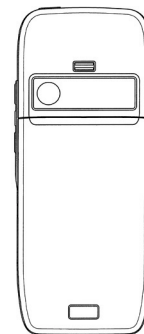
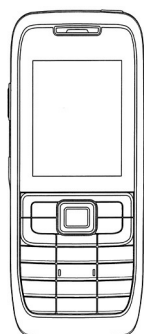

(11) **Rahvusvah reg nr**

**DM/070075**

(51) Klass: **26-06**

(21) **Rahvusvah reg jrk**

H200800016

(15) **Registreeringu päev**

06.05.2008

(28) **Variantide arv**

2

(72) **Autor**

*Autori andmeid ei avalikustata*

(73) **Omanik**

VALEO VISION, 34 rue Saint-André, F-93012 BOBIGNY Cedex, FR

**WIPO Rahvusvah Tööstusdisainilahenduste**

**Bülletääni nr, kus registreering on avaldatud** 2008/05

(55) **Reproduksioon**

DM/070075-1



DM/070075-2



(11) <b>Rahvusvah reg nr</b>	<b>DM/070165</b>	(51) <b>Klass: 26-06</b>
(21) <b>Rahvusvah reg jrk</b>	H200800041	
(15) <b>Registreeringu päev</b>	14.05.2008	
(28) <b>Variantide arv</b>	1	
(72) <b>Autor</b>	Hans-Dieter Futschik Stefan Handt Steffen Koehl Frank Pfisterer	
(73) <b>Omanik</b>	DAIMLER AG, Mercedesstrasse 137, 70327 Stuttgart, DE	
<b>WIPO Rahvusvah Tööstusdisainilahenduste Bülletääni nr, kus registreering on avaldatud</b>	2008/10	

(55) **Reproduksioon**

DM/070165-1

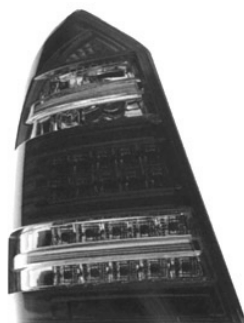

(11) **Rahvusvah reg nr**

**DM/070246**

(51) Klass: **02-04**

(21) **Rahvusvah reg jrk**

H200800037

(15) **Registreeringu päev**

05.05.2008

(28) **Variantide arv**

1

(72) **Autor**

Johan M. Krommenhoek

(73) **Omanik**

JOHAN M. KROMMENHOEK, Lärchenring 15, CH-7270 Davos-Platz,  
CH

**WIPO Rahvusvah Tööstusdisainilahenduste**

**Bülletääni nr, kus registreering on avaldatud** 2008/10

(55) **Reproduksioon**

DM/070246-1

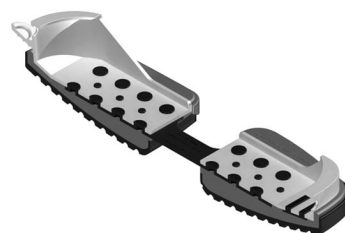
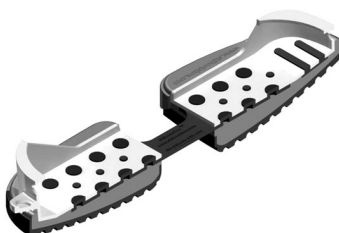
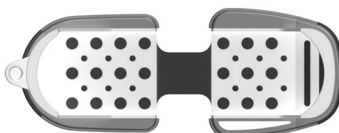

(11) <b>Rahvusvah reg nr</b>	<b>DM/070661</b>	(51) <b>Klass: 10-01</b>
(21) <b>Rahvusvah reg jrk</b>	H200800032	
(15) <b>Registreeringu päev</b>	11.03.2008	
(28) <b>Variantide arv</b>	1	
(72) <b>Autor</b>	Vanvooren Luc	
(73) <b>Omanik</b>	ALPHATRONICS NV, Brandstraat 8A, B-9160 Lokeren, BE	
<b>WIPO Rahvusvah Tööstusdisainilahenduste</b>		
<b>Bülletääni nr, kus registreering on avaldatud</b>	2008/9	

(55) **Reproduksioon**

DM/070661-1

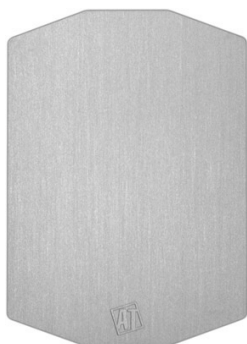

(11) **Rahvusvah reg nr**

**DM/070671**

(51) Klass: **12-16**

(21) **Rahvusvah reg jrk**

H200800031

(15) **Registreeringu päev**

30.07.2008

(28) **Variantide arv**

2

(72) **Autor**

Kurt Bierenbreier

(73) **Omanik**

IMPERIAL GMBH, Kolpingstrasse 14, 76473 Iffezheim, DE

**WIPO Rahvusvah Tööstusdisainilahenduste**

**Bülletääni nr, kus registreering on avaldatud** 2008/09

(55) **Reproduktsoon**

DM/070671-1



DM/070671-2

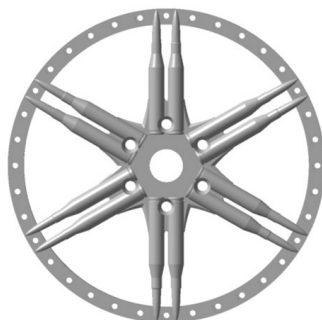
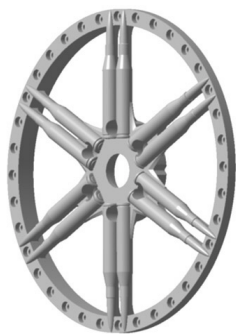

(11) **Rahvusvah reg nr**

**DM/070708**

(51) **Klass: 06-03**

(21) **Rahvusvah reg jrk**

H200800030

(15) **Registreeringu päev**

22.09.2008

(28) **Variantide arv**

1

(72) **Autor**

ALFIO PADOVAN

(73) **Omanik**

F&F SRL, Via Peperate, 25/L, I-33082 AZZANO DECIMO (PN), IT

**WIPO Rahvusvah Tööstusdisainilahenduste**

**Bülletääni nr, kus registreering on avaldatud** 2008/09

(55) **Reproduktsoon**

DM/070708-1

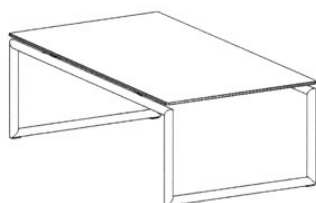
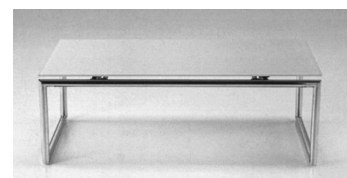
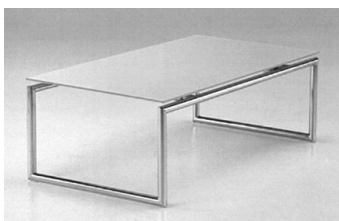
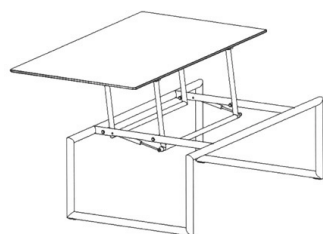
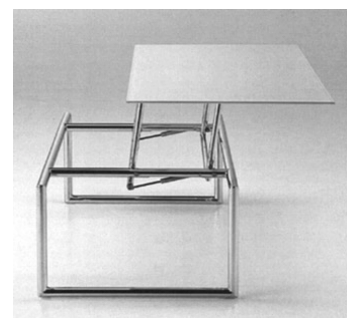
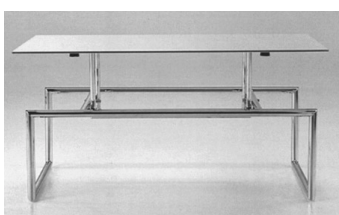
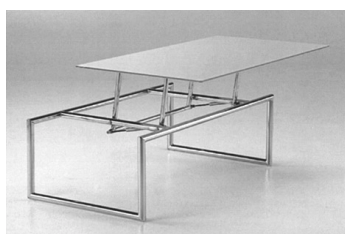



### III. MUUD REGISTRIKANDED

#### REGISTREERINGU KEHTIVUSE PIKENDAMINE

Reg nr	Registreeringu pikendatud kehtivusaja lõppemise päev
--------	--

00326	03.12.2013	00348	16.02.2014
00329	03.12.2013	00349	11.12.2013
00330	03.12.2013	00370	15.02.2014
00331	03.12.2013	00911	05.01.2014
00338	10.12.2013	00912	07.01.2014
00341	22.12.2013	00922	21.01.2014
00342	22.12.2013	00923	27.01.2014
00343	22.12.2013	00934	19.12.2013

#### TÖÖSTUSDISAINILAHENDUSE ÜLEMINEK

Reg nr	Uue omaniku andmed	Registrikande jõustumise päev
00370	Metsä Tissue Oyj, Revontulentie 8 C, FI-02100 Espoo, FI	02.12.2008
00934	UAB "BALTIC PLASTIC PRODUCTS", Krašto g. 37, Neveronių k., LT-54477 Kauno r., LT	04.12.2008

#### REGISTREERINGU ANDMETE MUUDATUSED

Reg nr	Muutunud andmed	Registrikande jõustumise päev
00911	Tchibo GmbH, Überseering 18, 22297 Hamburg, DE	18.11.2008

#### REGISTREERINGU KUSTUTAMINE

"Tööstusdisaini kaitse seaduse" paragrahvi 77 lõike 1 alusel on registrist kustutatud järgmised tööstusdisainilahendused:

Reg nr	Kustutamise kande jõustumise päev
--------	-----------------------------------

00250	15.05.2008	00283	18.06.2008	00849	17.07.2008
00252	25.05.2008	00319	09.06.2008	00850	17.07.2008
00255	18.06.2008	00810	02.05.2008	00851	17.07.2008
00256	18.06.2008	00822	28.04.2008	00852	17.07.2008
00258	18.06.2008	00823	28.04.2008	00853	17.07.2008
00262	30.04.2008	00824	06.05.2008	00855	11.06.2008
00268	18.06.2008	00825	27.05.2008	00857	02.07.2008
00269	18.06.2008	00826	26.06.2008	00865	04.07.2008
00274	18.06.2008	00844	15.07.2008	00868	17.07.2008
00275	18.06.2008	00847	30.04.2008	00869	17.07.2008
00281	18.06.2008	00848	17.07.2008	00870	17.07.2008

## IV. LOENDID

REGISTREERITUD TÖÖSTUSDISAINILAHENDUSTE REGISTREERIMISE TAOTLUSTE  
NUMBRILINE LOEND

Registreerimis- taotluse number	Registreeringu number
------------------------------------	--------------------------

D200800035	01492	D200800088	01497
D200800081	01493	D200800090	01498
D200800084	01494	D200800091	01499
D200800085	01495	D200800092	01500
D200800087	01496		

RAHVUSVAHELISELT REGISTREERITUD TÖÖSTUSDISAINILAHENDUSTE  
NUMBRILINE LOEND

Rahvusvah reg jrk	Rahvusvah reg nr
-------------------	------------------

H200800007	DM/069676	H200800030	DM/070708
H200800010	DM/069502	H200800031	DM/070671
H200800011	DM/070031	H200800032	DM/070661
H200800012	DM/070035	H200800034	DM/069942
H200800013	DM/069532	H200800035	DM/069600
H200800014	DM/069554	H200800037	DM/070246
H200800016	DM/070075	H200800041	DM/070165

## V. TÖÖSTUSDISAINIALASED ÕIGUSAKTID JA MUU INFO

### RIIKLIKUS PATENDIVOLNIKE REGISTRIS REGISTREERITUD PATENDIVOLNIKE NIMEKIRI (seisuga 8. jaanuar 2009)

Register on asutatud 1. septembril 2001. a Vabariigi Valitsuse 7. augusti 2001. a määrusega nr 271 "Riikliku patendivolinike registri asutamine ja registri pidamise põhimäärus" (RT I 2001, 70, 426) patendivoliniku seaduse § 21 alusel (RT I 2001, 27, 151).

#### TEGEVUSVALDKOND: KAUBAMÄRK, TÖÖSTUSDISAINILAHENDUS JA GEOGRAAFILINE TÄHIS

<b>Arno ANIJALG</b>	<b>OÜ USTERVALL</b> Kivi 21-6 51009 Tartu pk 21, 51002 Tartu telefon: 744 1980 telefaks: 744 1785 e-post: anijalg@ustervall.ee http://www.ustervall.ee võõrkeeled: saksa, vene	<b>Juhan HÄMMALOV</b>	<b>OÜ Intels</b> Magasini 12 51005 Tartu telefon: 742 0401 telefaks: 742 0326 e-post: intels@intels.ee http://www.intels.ee võõrkeeled: inglise, saksa, vene
<b>Aivo ARULA</b>	<b>Patendibüroo Käosaar &amp; Co OÜ</b> Tähe 94 50107 Tartu telefon: 738 3051 telefaks: 738 3055 e-post: info@kaosaar.ee http://www.kaosaar.ee võõrkeeled: inglise, vene	<b>Uno JÄÄGER</b>	<b>Inseneribüroo Uneko OÜ</b> Rüütli 51a, 80010 Pärnu telefon: 447 1021 telefaks: 447 1001 GSM: 515 1844 e-post: uno@estpak.ee võõrkeeled: inglise, soome, vene
<b>Martina BÖCKLER-LORVI</b>	<b>OÜ LASVET</b> Suurtüki 4a, 10133 Tallinn pk 3136, 10505 Tallinn telefon: 640 6600 telefaks: 640 6604 e-post: lasvet@lasvet.ee http://www.lasvet.ee võõrkeeled: inglise, soome	<b>Sirje KAHU</b>	<b>OÜ USTERVALL</b> Kivi 21-6 51009 Tartu pk 21, 51002 Tartu telefon: 744 1980 telefaks: 744 1785 e-post: skahu@ustervall.ee http://www.ustervall.ee võõrkeeled: inglise, vene
<b>Indrek EELMETS</b>	<b>Advokaadibüroo Sorainen OÜ</b> Pärnu mnt 15 10141 Tallinn telefon: 640 0900 telefaks: 640 0901 e-post: sorainen@sorainen.ee http://www.sorainen.com võõrkeeled: inglise, vene, soome	<b>Lembit KALEV</b>	<b>Patendibüroo ROOSILLA OÜ</b> Järveotsa tee 39-61 13520 Tallinn telefon: 657 1722, 657 5381 telefaks: 657 5381 GSM: 511 9951 e-post: roosilla@roosilla.ee http://www.roosilla.ee võõrkeeled: inglise, vene
<b>Alla HÄMMALOV</b>	<b>OÜ Intels</b> Magasini 12 51005 Tartu telefon: 742 0401 telefaks: 742 0326 e-post: intels@intels.ee http://www.intels.ee võõrkeeled: inglise, poola, vene	<b>Anneli KANG</b>	<b>OÜ Synest</b> pk 977, 13402 Tallinn telefon: 660 9786 telefaks: 660 9787 e-post: anneli@synest.ee võõrkeeled: inglise, saksa, vene, prantsuse, soome, rootsi

- Urmast KAULER** **Patendibüroo TURVAJA OÜ**  
Liivalaia 22  
10118 Tallinn  
telefon: 640 3109  
telefaks: 640 3105  
e-post: turvaja@turvaja.ee  
http://www.turvaja.ee  
võõrkeeled: inglise, vene, soome
- Urmast KERNU** **AAA Patendibüroo OÜ**  
Tartu mnt 16  
10117 Tallinn  
pk 3926, 10509 Tallinn  
telefon: 660 5910, 660 5911  
telefaks: 660 5912  
e-post: aaa@aaa.ee  
http://www.aaa.ee  
võõrkeeled: inglise, saksa, soome, vene
- Ljubov KESSELMAN** **OÜ Kesna**  
Tedre 77-52  
10616 Tallinn  
telefon: 660 8068  
telefaks: 660 8069  
e-post: kesna@kesna.ee  
http://www.kesna.ee  
võõrkeeled: inglise, vene
- Marina KESSELMAN** **OÜ Kesna**  
Tedre 77-52  
10616 Tallinn  
telefon: 660 8068  
telefaks: 660 8069  
e-post: kesna@kesna.ee  
http://www.kesna.ee  
võõrkeeled: inglise, saksa, vene
- Heinu KOITEL** **Patendi- & Kaubamärgibüroo Koitel OÜ**  
Tartu mnt 65  
10115 Tallinn  
pk 1759, 10902 Tallinn  
telefon: 603 3260  
telefaks: 603 3261  
e-post: koitel@koitel.ee  
http://www.koitel.ee  
võõrkeeled: inglise, soome, vene
- Raivo KOITEL** **Patendi- & Kaubamärgibüroo Koitel OÜ**  
Tartu mnt 65  
10115 Tallinn  
pk 1759, 10902 Tallinn  
telefon: 603 3260  
telefaks: 603 3261  
e-post: koitel@koitel.ee  
http://www.koitel.ee  
võõrkeeled: inglise, soome, vene
- Katrin KOITEL-VEIDIK** **Patendi- & Kaubamärgibüroo Koitel OÜ**  
Tartu mnt 65  
10115 Tallinn  
pk 1759, 10902 Tallinn  
telefon: 603 3260  
telefaks: 603 3261  
e-post: koitel@koitel.ee  
http://www.koitel.ee  
võõrkeeled: inglise, soome
- Mart Enn KOPPEL** **Patendibüroo Koppel OÜ**  
Kajaka 4-10  
11317 Tallinn  
telefon: 677 4136  
telefaks: 677 4138  
e-post: info@koppelpb.com  
http://www.koppelpb.com  
võõrkeeled: inglise, vene, soome
- Heinrich KRUPP** **Patendibüroo TURVAJA OÜ**  
Liivalaia 22  
10118 Tallinn  
telefon: 640 3109  
telefaks: 640 3105  
e-post: turvaja@turvaja.ee  
http://www.turvaja.ee  
võõrkeeled: saksa, vene
- Jüri KÄOSAAR** **Patendibüroo Käosaar & Co OÜ**  
Tähe 94  
50107 Tartu  
telefon: 738 3051  
telefaks: 738 3055  
e-post: info@kaosaar.ee  
http://www.kaosaar.ee  
võõrkeeled: inglise, vene
- Kalev KÄOSAAR** **Patendibüroo Käosaar & Co OÜ**  
Peterburi tee 46  
11415 Tallinn  
telefon: 637 9484  
telefaks: 637 9485  
e-post: kalev.kaosaar@kaosaar.ee  
http://www.kaosaar.ee  
võõrkeeled: inglise, vene
- Kristjan LEPPIK** **Patendibüroo TURVAJA OÜ**  
Liivalaia 22  
10118 Tallinn  
telefon: 640 3109  
telefaks: 640 3105  
e-post: turvaja@turvaja.ee  
http://www.turvaja.ee  
võõrkeeled: inglise, vene

<b>Reet MAASIKAMÄE</b>	<b>OÜ Kaitsepurus</b> Mulla 4-3 10611 Tallinn telefon: 673 9097, 633 2798 telefaks: 677 4844 e-post: purus@online.ee purus@hot.ee http://www.hot.ee/purus/ võõrkeeled: inglise, vene	<b>Tõnu NELSAS</b>	<b>AAA Patendibüroo OÜ</b> Tartu mnt 16 10117 Tallinn pk 3926, 10509 Tallinn telefon: 660 5910, 660 5911 telefaks: 660 5912 e-post: aaa@aaa.ee http://www.aaa.ee võõrkeeled: inglise, vene, soome
<b>Raivo MATSOO</b>	<b>RM Hirvela Patendibüroo OÜ</b> Saku 15, 11314 Tallinn telefon: 614 0816 telefaks: 614 0818 e-post: hirvela@hirvela.ee võõrkeeled: inglise, vene	<b>Jüri OLT</b>	<b>Patendibüroo Käosaar &amp; Co OÜ</b> Tähe 94, 50107 Tartu telefon: 738 3051 telefaks: 738 3055 e-post: info@kaosaar.ee http://www.kaosaar.ee võõrkeeled: inglise, saksa, soome, vene
<b>Elle MELLIK</b>	<b>AAA Patendibüroo OÜ</b> Tartu mnt 16 10117 Tallinn pk 3926, 10509 Tallinn telefon: 660 5910, 660 5911 telefaks: 660 5912 e-post: aaa@aaa.ee http://www.aaa.ee võõrkeeled: inglise, vene	<b>Jaak OSTRAT</b>	<b>OÜ LASVET</b> Suurtüki 4a, 10133 Tallinn pk 3136, 10505 Tallinn telefon: 640 6600 telefaks: 640 6604 e-post: lasvet@lasvet.ee http://www.lasvet.ee võõrkeeled: inglise, saksa, soome, vene
<b>Lembit MITT</b>	<b>AAA Patendibüroo OÜ</b> Tartu mnt 16, 10117 Tallinn pk 3926, 10509 Tallinn telefon: 660 5910, 660 5911 telefaks: 660 5912 e-post: aaa@aaa.ee http://www.aaa.ee võõrkeeled: inglise, vene	<b>Villu PAVELTS</b>	<b>OÜ LASVET</b> Suurtüki 4a, 10133 Tallinn pk 3136, 10505 Tallinn telefon: 640 6600 telefaks: 640 6604 e-post: lasvet@lasvet.ee http://www.lasvet.ee võõrkeeled: inglise, soome, vene
<b>Ott MOORLAT</b>	<b>OÜ Moorlat &amp; Ko Patendibüroo</b> pk 723, 12902 Tallinn telefon: 655 0450, 654 2844 telefaks: 654 2844 e-post: ott.moorlat@moorlat.ee http://www.moorlat.ee võõrkeeled: inglise, vene	<b>Toom PUNGAS</b>	<b>OÜ Synest</b> pk 977, 13402 Tallinn telefon: 660 9786 telefaks: 660 9787 e-post: toom@synest.ee võõrkeeled: inglise, saksa, soome, vene
<b>Anfia MORNA</b>	<b>Patendibüroo TURVAJA OÜ</b> Liivalaia 22, 10118 Tallinn telefon: 640 3109 telefaks: 640 3105 e-post: turvaja@turvaja.ee http://www.turvaja.ee võõrkeeled: inglise, vene	<b>Kaie PUUR</b>	<b>Advokaadibüroo Rando Antsmäe OÜ</b> Raekoja plats 13, 51004 Tartu telefon: 742 2770 telefaks: 742 2771 <b>Advokaadibüroo Rando Antsmäe OÜ</b> Pärnu mnt 130-42, 11317 Tallinn telefon: 656 7450 telefaks: 656 7460 e-post: kaie.puur@antsmae.ee http://www.antsmae.ee võõrkeeled: inglise, vene, saksa
<b>Mari MUST</b>	<b>Raidla Lejins &amp; Norcous Advokaadibüroo OÜ</b> Roosikrantsi 2, 10119 Tallinn telefon: 640 7170 telefaks: 640 7171 e-post: mari.must@rln.ee http://www.rln.ee võõrkeeled: inglise, soome		

**Linnar PUUSEPP****OÜ LASVET**

Suurtüki 4a, 10133 Tallinn  
pk 3136, 10505 Tallinn  
telefon: 640 6600  
telefaks: 640 6604  
e-post: lasvet@lasvet.ee  
http://www.lasvet.ee  
võõrkeeled: inglise, vene

**Harald TEHVER****Patendibüroo TURVAJA OÜ**

Liivalaia 22  
10118 Tallinn  
telefon: 640 3109  
telefaks: 640 3105  
e-post: turvaja@turvaja.ee  
http://www.turvaja.ee  
võõrkeeled: inglise, saksa, vene

**Riina PÄRN****OÜ Intels**

Magasini 12  
51005 Tartu  
telefon: 742 0401  
telefaks: 742 0326  
e-post: intels@intels.ee  
http://www.intels.ee  
võõrkeeled: inglise, vene

**Olga TREUFELDT****Patendibüroo TURVAJA OÜ**

Liivalaia 22  
10118 Tallinn  
telefon: 640 3109  
telefaks: 640 3105  
e-post: turvaja@turvaja.ee  
http://www.turvaja.ee  
võõrkeeled: inglise, vene

**Tarmo ROSMAN****Rosman ja Partnerid OÜ**

pk 652, 12602 Tallinn  
telefon: 656 1450  
telefaks: 656 1450  
e-post: tarman@cc.ttu.ee  
võõrkeeled: saksa, inglise, ungari,  
vene

**Enn URGAS****Patendibüroo TURVAJA OÜ**

Liivalaia 22  
10118 Tallinn  
telefon: 640 3109  
telefaks: 640 3105  
e-post: turvaja@turvaja.ee  
http://www.turvaja.ee  
võõrkeeled: inglise, vene

**Arvo SALUMÄE****OÜ Amende Patendibüroo**

Raua 65  
10152 Tallinn  
telefon: 648 6125  
telefaks: 641 0174  
e-post: amende@hot.ee  
võõrkeeled: inglise, saksa, soome,  
vene

**Juta-Maris UUSTALU****OÜ Amende Patendibüroo**

Raua 65  
10152 Tallinn  
telefon: 648 6125  
telefaks: 641 0174  
e-post: amende@hot.ee  
võõrkeeled: inglise, vene

**Almar SEHVER****AAA Patendibüroo OÜ**

Tartu mnt 16  
10117 Tallinn  
pk 3926, 10509 Tallinn  
telefon: 660 5910, 660 5911  
telefaks: 660 5912  
e-post: aaa@aaa.ee  
http://www.aaa.ee  
võõrkeeled: inglise, vene

**LIST OF PATENT ATTORNEYS, REGISTERED IN  
THE ESTONIAN STATE REGISTER OF PATENT ATTORNEYS**  
(by 8 January 2009)

Register is established on September 1<sup>st</sup> 2001

**FIELD OF ACTIVITY: TRADEMARKS, INDUSTRIAL DESIGNS AND GEOGRAPHICAL INDICATIONS**

- |                                  |   |                       |   |
|----------------------------------|---|-----------------------|---|
| <b>Arno ANIJALG</b>              | <b>USTERVALL Ltd.</b><br>Kivi 21-6<br>51009 Tartu, Estonia<br>P.O. Box 21<br>51002 Tartu, Estonia<br>Phone: +372 744 1980<br>Fax: +372 744 1785<br>E-mail: anijalg@ustervall.ee<br>Http://www.ustervall.ee<br>German, Russian, Estonian | <b>Juhan HÄMMALOV</b> | <b>Intels Ltd.</b><br>Magasini 12<br>51005 Tartu, Estonia<br>Phone: +372 742 0401<br>Fax: +372 742 0326<br>E-mail: intels@intels.ee<br>Http://www.intels.ee<br>English, German, Russian,<br>Estonian  |
| <b>Aivo ARULA</b>                | <b>Patent Agency Käosaar &amp; Co</b><br>Tähe Str. 94<br>50107 Tartu, Estonia<br>Phone: +372 738 3051<br>Fax: +372 738 3055<br>E-mail: info@kaosaar.ee<br>Http://www.kaosaar.ee<br>English, Russian, Estonian                           | <b>Uno JÄÄGER</b>     | <b>Inseneribüroo Uneko Ltd.</b><br>Rüütli 51a<br>80010 Pärnu, Estonia<br>Phone: +372 447 1021<br>Fax: +372 447 1001<br>GSM: +372 515 1844<br>E-mail: uno@estpak.ee<br>English, Finnish, Russian,<br>Estonian  |
| <b>Martina<br/>BÖCKLER-LORVI</b> | <b>Lasvet Ltd.</b><br>P.O. Box 3136<br>10505 Tallinn, Estonia<br>Phone: +372 640 6600<br>Fax: +372 640 6604<br>E-mail: lasvet@lasvet.ee<br>Http://www.lasvet.ee<br>English, Finnish, Estonian   | <b>Sirje KAHU</b>     | <b>USTERVALL Ltd.</b><br>Kivi 21-6<br>51009 Tartu, Estonia<br>P.O. Box 21<br>51002 Tartu, Estonia<br>Phone: +372 744 1980<br>Fax: +372 744 1785<br>E-mail: skahu@ustervall.ee<br>Http://www.ustervall.ee<br>English, Russian, Estonian                            |
| <b>Indrek EELMETS</b>            | Sorainen Law Office<br>Pärnu Road 15<br>10141 Tallinn, Estonia<br>Phone: +372 640 0900<br>Fax: +372 640 0901<br>E-mail: sorainen@sorainen.ee<br>Http://www.sorainen.com<br>English, Russian, Finnish,<br>Estonian                       | <b>Lembit KALEV</b>   | <b>Patent Bureau ROOSILLA Ltd.</b><br>Järveotsa Road 39-61<br>13520 Tallinn, Estonia<br>Phone: +372 657 1722<br>+372 657 5381<br>Fax: +372 657 5381<br>GSM: +372 511 9951<br>E-mail: roosilla@roosilla.ee<br>Http://www.roosilla.ee<br>English, Russian, Estonian |
| <b>Alla HÄMMALOV</b>             | <b>Intels Ltd.</b><br>Magasini 12<br>51005 Tartu, Estonia<br>Phone: +372 742 0401<br>Fax: +372 742 0326<br>E-mail: intels@intels.ee<br>Http://www.intels.ee<br>English, Polish, Russian,<br>Estonian                                    | <b>Anneli KANG</b>    | <b>Synest Ltd.</b><br>P.O. Box 977<br>13402 Tallinn, Estonia<br>Phone: +372 660 9786<br>Fax: +372 660 9787<br>E-mail: anneli@synest.ee<br>English, German, Russian,<br>French, Finnish, Swedish,  |

- Urmast KAULER** Estonian  
**Patendibüroo TURVAJA OÜ**  
 Liivalaia 22  
 10118 Tallinn, Estonia  
 Phone: +372 640 3109  
 Fax: +372 640 3105  
 E-mail: turvaja@turvaja.ee  
 Http://www.turvaja.ee  
 English, Russian, Finnish,  
 Estonian
- Urmast KERNU** **AAA Legal Services**  
 Tartu Road 16  
 10117 Tallinn, Estonia  
 P.O. Box 3926  
 10509 Tallinn, Estonia  
 Phone: +372 660 5910  
 +372 660 5911  
 Fax: +372 660 5912  
 E-mail: aaa@aaa.ee  
 Http://www.aaa.ee  
 English, German, Finnish,  
 Russian, Estonian
- Marina KESSELMAN** **Kesna Ltd.**  
 Tedre Str. 77-52  
 10616 Tallinn, Estonia  
 Phone: +372 660 8068  
 Fax: +372 660 8069  
 E-mail: kesna@kesna.ee  
 Http://www.kesna.ee  
 English, German, Russian,  
 Estonian
- Ljubov KESSELMAN** **Kesna Ltd.**  
 Tedre Str. 77-52  
 10616 Tallinn, Estonia  
 Phone: +372 660 8068  
 Fax: +372 660 8069  
 E-mail: kesna@kesna.ee  
 Http://www.kesna.ee  
 English, Russian, Estonian
- Heinu KOITEL** **Patent & Trademark Agency Koitel**  
 Tartu Road 65  
 10115 Tallinn, Estonia  
 P.O. Box 1759  
 10902 Tallinn, Estonia  
 Phone: +372 603 3260  
 Fax: +372 603 3261  
 E-mail: koitel@koitel.ee  
 Http://www.koitel.ee  
 English, Finnish, Russian,  
 Estonian
- Raivo KOITEL** **Patent & Trademark Agency Koitel**  
 Tartu Road 65  
 10115 Tallinn, Estonia  
 P.O. Box 1759  
 10902 Tallinn, Estonia  
 Phone: +372 603 3260  
 Fax: +372 603 3261  
 E-mail: koitel@koitel.ee  
 Http://www.koitel.ee  
 English, Finnish, Russian,  
 Estonian
- Katrin KOITEL-VEIDIK** **Patent & Trademark Agency Koitel**  
 Tartu Road 65  
 10115 Tallinn, Estonia  
 P.O. Box 1759  
 10902 Tallinn, Estonia  
 Phone: +372 603 3260  
 Fax: +372 603 3261  
 E-mail: koitel@koitel.ee  
 Http://www.koitel.ee  
 English, Finnish, Estonian
- Mart Enn KOPPEL** **Patent Bureau Koppel**  
 Kajaka 4-10  
 11317 Tallinn, Estonia  
 Phone: +372 677 4136  
 Fax: +372 677 4138  
 E-mail: info@koppelpb.com  
 Http://www.koppelpb.com  
 English, Russian, Finnish,  
 Estonian
- Heinrich KRUPP** **Patendibüroo TURVAJA OÜ**  
 Liivalaia 22  
 10118 Tallinn, Estonia  
 Phone: +372 640 3109  
 Fax: +372 640 3105  
 E-mail: turvaja@turvaja.ee  
 Http://www.turvaja.ee  
 German, Russian, Estonian
- Jüri KÄOSAAR** **Patent Agency Käosaar & Co**  
 Tähe Str. 94  
 50107 Tartu, Estonia  
 Phone: +372 738 3051  
 Fax: +372 738 3055  
 E-mail: info@kaosaar.ee  
 Http://www.kaosaar.ee  
 English, Russian, Estonian
- Kalev KÄOSAAR** **Patent Agency Käosaar & Co**  
 Peterburi Road 46  
 11415 Tallinn, Estonia  
 Phone: +372 637 9484  
 Fax: +372 637 9485  
 E-mail:  
 kalev.kaosaar@kaosaar.ee  
 Http://www.kaosaar.ee  
 English, Russian, Estonian



<b>Kristjan LEPPIK</b>	<b>Patendibüroo TURVAJA OÜ</b> Liivalaia 22 10118 Tallinn, Estonia Phone: +372 640 3109 Fax: +372 640 3105 E-mail: turvaja@turvaja.ee Http://www.turvaja.ee English, Russian, Estonian	<b>Anfia MORNA</b>	<b>Patendibüroo TURVAJA OÜ</b> Liivalaia 22 10118 Tallinn, Estonia Phone: +372 640 3109 Fax: +372 640 3105 E-mail: turvaja@turvaja.ee Http://www.turvaja.ee English, Russian, Estonian
<b>Reet MAASIKAMÄE</b>	<b>Patent Bureau Kaitsepurus Ltd.</b> Mulla Str. 4-3 10611 Tallinn, Estonia Phone: +372 673 9097 +372 633 2798 Fax: +372 677 4844 E-mail: purus@online.ee purus@hot.ee Http://www.hot.ee/purus/ English, Russian, Estonian	<b>Mari MUST</b>	<b>Raidla Lejins &amp; Norcoux Advokaadibüroo OÜ</b> Roosikrantsi 2 10119 Tallinn, Estonia Phone: +372 640 7170 Fax: +372 640 7171 E-mail: mari.must@rln.ee Http://www.rln.ee English, Finnish, Estonian
<b>Raivo MATSOO</b>	<b>RM Hirvela Patent Bureau Ltd</b> Saku 15, 11314 Tallinn, Estonia Phone: +372 614 0816 Fax: +372 614 0818 E-mail: hirvela@hirvela.ee English, Russian, Estonian	<b>Tõnu NELSAS</b>	<b>AAA Legal Services</b> Tartu Road 16 10117 Tallinn, Estonia P.O. Box 3926 10509 Tallinn, Estonia Phone: +372 660 5910 +372 660 5911 Fax: +372 660 5912 E-mail: aaa@aaa.ee Http://www.aaa.ee English, Russian, Finnish, Estonian
<b>Elle MELLIK</b>	<b>AAA Legal Services</b> Tartu Road 16 10117 Tallinn, Estonia P.O. Box 3926 10509 Tallinn, Estonia Phone: +372 660 5910 +372 660 5911 Fax: +372 660 5912 E-mail: aaa@aaa.ee Http://www.aaa.ee English, Russian, Estonian	<b>Jüri OLT</b>	<b>Patent Agency Käosaar &amp; Co</b> Tähe Str. 94 50107 Tartu, Estonia Phone: +372 738 3051 Fax: +372 738 3055 E-mail: info@kaosaar.ee Http://www.kaosaar.ee English, German, Finnish, Russian, Estonian
<b>Lembit MITT</b>	<b>AAA Legal Services</b> Tartu Road 16 10117 Tallinn, Estonia P.O. Box 3926 10509 Tallinn, Estonia Phone: +372 660 5910 +372 660 5911 Fax: +372 660 5912 E-mail: aaa@aaa.ee Http://www.aaa.ee English, Russian, Estonian	<b>Jaak OSTRAT</b>	<b>Lasvet Ltd.</b> P.O. Box 3136 10505 Tallinn, Estonia Phone: +372 640 6600 Fax: +372 640 6604 E-mail: lasvet@lasvet.ee Http://www.lasvet.ee English, German, Finnish, Russian, Estonian
<b>Ott MOORLAT</b>	<b>Moorlat &amp; Co Ltd. Patent Bureau</b> P.O. Box 723 12902 Tallinn, Estonia Phone: +372 655 0450 +372 654 2844 Fax: +372 654 2844 E-mail: ott.moorlat@moorlat.ee Http://www.moorlat.ee English, Russian, Estonian	<b>Villu PAVELTS</b>	<b>Lasvet Ltd.</b> P.O. Box 3136 10505 Tallinn, Estonia Phone: +372 640 6600 Fax: +372 640 6604 E-mail: lasvet@lasvet.ee Http://www.lasvet.ee English, Finnish, Russian, Estonian

- Toom PUNGAS**      **Synest Ltd.**  
P.O. Box 977  
13402 Tallinn, Estonia  
Phone: +372 660 9786  
Fax: +372 660 9787  
E-mail: toom@synest.ee  
English, German, Finnish,  
Russian, Estonian
- Kaie PUUR**      **Rando Antsmäe Law Office**  
Raekoja plats 13, 51004 Tartu,  
Estonia  
Phone: +372 742 2770  
Fax: +372 742 2771  
**Rando Antsmäe Law Office**  
Pärnu mnt 130-42,  
11317 Tallinn, Estonia  
Phone: +372 656 7450  
Fax: +372 656 7460  
E-mail: kaie.puur@antsmae.ee  
Http://www.antsmae.ee  
English, Russian, German,  
Estonian
- Linnar PUUSEPP**      **Lasvet Ltd.**  
P.O. Box 3136  
10505 Tallinn, Estonia  
Phone: +372 640 6600  
Fax: +372 640 6604  
E-mail: lasvet@lasvet.ee  
Http://www.lasvet.ee  
English, Russian, Estonian
- Riina PÄRN**      **Intels Ltd.**  
Magasini 12  
51005 Tartu, Estonia  
Phone: +372 742 0401  
Fax: +372 742 0326  
E-mail: intels@intels.ee  
Http://www.intels.ee  
English, Russian, Estonian
- Tarmo ROSMAN**      **Rosman and Partners Ltd.**  
P.O. Box 652  
12602 Tallinn, Estonia  
Phone: +372 656 1450  
Fax: +372 656 1450  
E-mail: tarman@cc.ttu.ee  
German, English, Hungarian,  
Russian, Estonian
- Arvo SALUMÄE**      **AMENDE Patent Agency  
Ltd.**  
Raua 65, 10152 Tallinn, Estonia  
Phone: +372 648 6125  
Fax: +372 641 0174  
E-mail: amende@hot.ee  
English, German, Finnish,  
Russian, Estonian
- Almar SEHVER**      **AAA Legal Services**  
Tartu Road 16  
10117 Tallinn, Estonia  
P.O. Box 3926  
10509 Tallinn, Estonia  
Phone: +372 660 5910  
+372 660 5911  
Fax: +372 660 5912  
E-mail: aaa@aaa.ee  
Http://www.aaa.ee  
English, Russian, Estonian
- Harald TEHVER**      **Patendibüroo TURVAJA OÜ**  
Liivalaia 22  
10118 Tallinn, Estonia  
Phone: +372 640 3109  
Fax: +372 640 3105  
E-mail: turvaja@turvaja.ee  
Http://www.turvaja.ee  
English, German, Russian,  
Estonian
- Olga TREUFELDT**      **Patendibüroo TURVAJA OÜ**  
Liivalaia 22  
10118 Tallinn, Estonia  
Phone: +372 640 3109  
Fax: +372 640 3105  
E-mail: turvaja@turvaja.ee  
Http://www.turvaja.ee  
English, Russian, Estonian
- Enn URGAS**      **Patendibüroo TURVAJA OÜ**  
Liivalaia 22  
10118 Tallinn, Estonia  
Phone: +372 640 3109  
Fax: +372 640 3105  
E-mail: turvaja@turvaja.ee  
Http://www.turvaja.ee  
English, Russian, Estonian
- Juta-Maris UUSTALU**      **AMENDE Patent Agency  
Ltd.**  
Raua 65, 10152 Tallinn, Estonia  
Phone: +372 648 6125  
Fax: +372 641 0174  
E-mail: amende@hot.ee  
English, Russian, Estonian