



ISSN 1406-376X

EESTI VABARIIK



**T EESTI
TÖÖSTUSDISAINI-
LAHENDUSE LEHT**



PATENDIAMETI AMETLIK VÄLJAANNE

3
2007
TALLINN



ISSN 1406-376X

EESTI VABARIIK

T **EESTI**
TÖÖSTUSDISAINI-
LAHENDUSE LEHT

**PATENDIAMETI
AMETLIK VÄLJAANNE**

X aastakäik

**Käesolevas numbris
esitatud andmed
loetakse avaldatuks
15. augustil 2007. a.**

3
2007
AUGUST
TALLINN

Eesti Tööstusdisainilahenduse Lehte antakse välja tööstusdisaini kaitse seaduse (jõustunud 11.01.1998) alusel.
The Estonian Industrial Design Gazette is the official publication of the Estonian Patent Office.
Published under Industrial Design Protection Law of the Republic of Estonia (coming into force 11 January 1998).
Date of publication of the data presented in this issue - 15 August 2007.

Patendiameti
infoosakond
Toompuiestee 7
15041 Tallinn
Tel 627 7907
Faks 627 7943
E-post Info@epa.ee

The Information Department
of the Estonian Patent Office
Toompuiestee 7
15041 Tallinn, ESTONIA
Phone +372 627 7907
Fax +372 627 7943
E-mail Info@epa.ee

Levitaja

Eesti Patendiraamatukogu
Olevimägi 8/10
10123 Tallinn
Tel 641 1248
Faks 641 1018
E-post patent@patentlib.ee

Distributor

Estonian Patent Library
Olevimägi 8/10
10123 Tallinn, ESTONIA
Phone +372 641 1248
Fax +372 641 1018
E-mail patent@patentlib.ee

SISUKORD

Andmete identifitseerimise rahvusvahelised numberkoodid (INID-koodid)	4
Riikide, teiste ühenduste ja valitsustevaheliste organisatsioonide koodid	5
I. REGISTREERITUD TÖÖSTUSDISAINILAHENDUSED	6
II. RAHVUSVAHELISELT REGISTREERITUD TÖÖSTUSDISAINILAHENDUSED	28
III. REGISTREERINGU KEHTIVUSE PIKENDAMINE	73
IV. TÖÖSTUSDISAINILAHENDUSE ÜLEMINEK	73
V. REGISTREERINGU JAGAMINE	-
VI. MUUD REGISTREERINGU ANDMETE MUUDATUSED	73
VII. REGISTREERINGU ANDMETE PARANDUSED	-
VIII. TÖÖSTUSDISAINILAHENDUSE LITSENTSIDE REGISTREERIMINE	-
IX. TÖÖSTUSDISAINILAHENDUSE PANTIDE REGISTREERIMINE	-
X. TUNNISTUSE DUPLIKAADI VÄLJAANDMINE	-
XI. TÖÖSTUSDISAINILAHENDUSE KUSTUTAMINE REGISTRIST	73
XII. LOENDID	74
Registreeritud tööstusdisainilahenduste süstemaatiline loend	74
Registreeritud tööstusdisainilahenduste registreerimistaotluste numbriline loend	74
Avaldatud rahvusvahelise registreeringu registreerimise otsuse teadete numbriline loend	74
XIII. TÖÖSTUSDISAINIALASED ÕIGUSAKTID JA MUU INFO	75
Riiklikus patendivolinike registris registreeritud patendivolinike nimekiri	75

CONTENTS

Internationally Agreed Numbers for the Identification of Data (INID Codes)	4
List of Codes of States, Other Entities and Intergovernmental Organizations	5
I. REGISTERED INDUSTRIAL DESIGNS	6
II. INTERNATIONALLY REGISTERED INDUSTRIAL DESIGNS	28
III. EXTENSION OF THE REGISTRATION	73
IV. TRANSFER OF INDUSTRIAL DESIGN	73
V. DIVISION OF THE REGISTRATION.	-
VI. OTHER AMENDMENTS TO REGISTRATION DATA	73
VII. CORRECTIONS TO REGISTRATION DATA	-
VIII. REGISTERING OF LICENSES OF INDUSTRIAL DESIGN	-
IX. REGISTERING OF PLEDGES OF INDUSTRIAL DESIGN	-
X. ISSUE OF A COPY OF THE INDUSTRIAL DESIGN CERTIFICATE	-
XI. DELETION OF INDUSTRIAL DESIGN FROM THE REGISTER	73
XII. LISTS	74
Systematic List of Registered Industrial Designs	74
Numerical List of Registration Applications of Registered Industrial Designs	74
Numerical List of Published Notices of Decisions on Registration of the International Registration	74
XIII. LEGAL ACTS AND INFORMATION CONCERNING INDUSTRIAL DESIGNS	75
List of Patent Attorneys, Registered in the Estonian State Register of Patent Attorneys	79

**ANDMETE IDENTIFITSEERIMISE
RAHVUSVAHELISED NUMBERKOODID
(INID-KOODID)
WIPO Standard ST. 80**

**INTERNATIONALLY AGREED NUMBERS FOR
THE IDENTIFICATION OF DATA
(INID CODES)
WIPO Standard ST. 80**

(11) Registreeringu number	(11) Number of the Registration
(15) Registreerimise kuupäev	(15) Date of the Registration
(18) Registreeringu kehtivuse lõppemise kuupäev	(18) Expected expiration date of the registration
(21) Registreerimistaotluse number	(21) Application Number
(22) Registreerimistaotluse esitamise kuupäev	(22) Application Filing Date
(24) Registreeringu kehtivuse alguse kuupäev	(24) Date from which the Industrial Design right has effected
(28) Variantide arv	(28) Number of Industrial Designs included in the application
(30) Prioriteet	(30) Priority
(51) Rahvusvahelise klassifikatsiooni klassi ja alaklassi number	(51) International Classification for Industrial Designs (class and subclass of the Locarno Classification)
(54) Tööstusdisainilahenduse nimetus	(54) Title of the Industrial Design
(55) Tööstusdisainilahenduse reproduktsioon	(55) Reproduction of the Industrial Design
(72) Tööstusdisainilahenduse autor(id)	(72) Author(s) of Industrial Design
(73) Tööstusdisainilahenduse omanik(ud)	(73) Proprietor(s) of Industrial Design
(74) Patendivolinik või ühine esindaja	(74) Patent Attorney or Common Representative

**RIIKIDE, TEISTE ÜHENDUSTE JA VALITSUSTEVAAHELISTE
ORGANISATSIOONIDE KOODID**

AD	Andorra	DZ	Alžeeria	JM	Jamaica	PW	Belau
AE	Araabia	EA	Euraasia	JO	Jordania	PY	Paraguay
	Ühendemiraadid		Patendiorganisat-	JP	Jaapan	QA	Katar
AF	Afganistan		sioon (EAPO)	KE	Kenya	RO	Rumeenia
AG	Antigua ja Barbuda	EC	Ecuador	KG	Kõrgõzstan	RS	Serbia
AI	Anguilla	EE	Eesti	KH	Kambodža	RU	Venemaa
AL	Albaania	EG	Egiptus	KI	Kiribati	RW	Rwanda
AM	Armeenia	EH	Lääne-Sahara	KM	Komoorid	SA	Saudi Araabia
AN	Hollandi Antillid	EM	Siseturu	KN	Saint Kitts ja Nevis	SB	Saalomoni Saared
AO	Angola		Ühtlustamise	KP	Põhja-Korea	SC	Seišellid
AP	Aafrika Regionaalne		Amet (kaubamärgid	KR	Lõuna-Korea	SD	Sudaan
	Tööstusomandi Orga-		ja tööstusdisaini-	KW	Kuveit	SE	Rootsi
	nisatsioon (ARIPO)		lahendused) (OHIM)	KY	Kaimanisaared	SG	Singapur
AR	Argentina	EP	Euroopa	KZ	Kasahstan	SH	Saint Helena
AS	Ameerika Samoa		Patendiamet (EPO)	LA	Laos	SI	Sloveenia
AT	Austria	ER	Eritrea	LB	Liibanon	SK	Slovakkia
AU	Austraalia	ES	Hispaania	LC	Saint Lucia	SL	Sierra Leone
AW	Aruba	ET	Etiopia	LI	Liechtenstein	SM	San Marino
AZ	Aserbaidžaan	FI	Soome	LK	Sri Lanka	SN	Senegal
BA	Bosnia ja	FJ	Fidži	LR	Libeeria	SO	Somaalia
	Hertsegoviina	FK	Falklandi (Malviini)	LS	Lesotho	SR	Suriname
BB	Barbados		saared	LT	Leedu	ST	São Tomé ja Príncipe
BD	Bangladesh	FM	Mikroneesia	LU	Luksemburg	SV	El Salvador
BE	Belgia	FO	Fääri saared	LV	Läti	SY	Süüria
BF	Burkina Faso	FR	Prantsusmaa	LY	Liibüa	SZ	Svaasimaa
BG	Bulgaaria	GA	Gabon	MA	Maroko	TC	Turks ja Caicos
BH	Bahrein	GB	Ühendkuningriik	MC	Monaco	TD	Tšaad
BI	Burundi		(Suurbritannia)	MD	Moldova	TG	Togo
BJ	Benin	GC	Pärsia Lahe	ME	Montenegro	TH	Tai
BM	Bermuda		Koostööõnukogu	MG	Madagaskar	TJ	Tadžikistan
BN	Brunei	GD	Grenada	MH	Marshalli Saared	TM	Türkmenistan
BO	Boliivia	GE	Gruusia	MK	Makedoonia	TN	Tuneesia
BR	Brasiilia	GG	Guernsey	ML	Mali	TO	Tonga
BS	Bahama	GH	Ghana	MM	Myanmar (Birma)	TL	Ida-Timor
BT	Bhutan	GI	Gibraltar	MN	Mongoolia	TR	Türgi
BV	Bouvet' saar	GL	Gröönimaa	MO	Macao	TT	Trinidad ja Tobago
BW	Botswana	GM	Gambia	MP	Põhja-Mariaanid	TV	Tuvalu
BX	Beneluxi	GN	Guinea	MR	Mauritaania	TW	Taiwan (Hiina provints)
	Kaubamärgiamet	GQ	Ekvatoriaal-Guinea	MS	Montserrat	TZ	Tansaania
	(BBM) ja Beneluxi	GR	Kreeka	MT	Malta	UA	Ukraina
	Tööstusdisainilahen-	GS	Lõuna-Georgia ja	MU	Mauritius	UG	Uganda
	duste Amet (BBDM)		Lõuna-Sandwichi	MV	Maldiivid	US	Ameerika
BY	Valgevene		saared	MW	Malawi		Ühendriigid
BZ	Belize	GT	Guatemala	MX	Mehhiko	UY	Uruguay
CA	Kanada	GW	Guinea-Bissau	MY	Malaisia	UZ	Usbekistan
CF	Kesk-Aafrika	GY	Guyana	MZ	Mosambiik	VA	Vatikan (Püha Tool)
	Vabariik	HK	Hongkong	NA	Namiibia	VC	Saint Vincent ja
CG	Kongo	HN	Honduras	NE	Niger		Grenadiinid
CH	Šveits	HR	Horvaatia	NG	Nigeeria	VE	Venezuela
CI	Côte d'Ivoire	HT	Haiti	NI	Nicaragua	VG	Neitsisaared
CK	Cooki saared	HU	Ungari	NL	Holland	VN	Vietnam
CL	Tšiili	IB	Ülemaailmse	NO	Norra	VU	Vanuatu
CM	Kamerun		Intellektuaalomandi	NP	Nepal	WO	Ülemaailmne
CN	Hiina		Organisatsiooni	NR	Nauru		Intellektuaalomandi
CO	Kolumbia		(WIPO) Rahvus-	NZ	Uus-Meremaa		Organisatsioon
CR	Costa Rica		vaheline Büroo	OA	Aafrika Intellektuaal-		(WIPO) (Rahvus-
CU	Kuuba	ID	Indoneesia		omandi Organisat-		vaheline Büroo)
CV	Cabo Verde	IE	Iiri		sioon (OAPI)	WS	Samoa
CY	Küpros	IL	Iisrael	OM	Omaan	YE	Jeemen
CZ	Tšehhi	IM	Man'i saar	PA	Panama	ZA	Lõuna-Aafrika Vabariik
DE	Saksamaa	IN	India	PE	Peruu	ZM	Sambia
DJ	Djibouti	IQ	Iraak	PG	Paapua Uus-Guinea	ZR	Zaire
DK	Taani	IR	Iraan	PH	Filipiinid	ZW	Zimbabwe
DM	Dominica	IS	Island	PK	Pakistan		
DO	Dominikaani	IT	Itaalia	PL	Poola		
	Vabariik	JE	Jersey	PT	Portugal		

I. REGISTREERITUD TÖÖSTUSDISAINILAHENDUSED

Avaldatakse "Tööstusdisaini kaitse seaduse" § 55¹ lõike 7 alusel.

Patendiamet ei ole kontrollinud tööstusdisainilahenduse uudsust ja eristatavust tulenevalt "Tööstusdisaini kaitse seaduse" § 31 lõike 2 punktist 1.

- (11) **Registreeringu number** **01311**
- (21) **Taotluse number** D200500080
- (15) **Registreerimise päev** 15.08.2007
- (22) **Esitamise päev** 09.12.2005
- (24) **Registreeringu kehtivuse alguse päev** 09.12.2005
- (18) **Registreeringu kehtivuse lõppemise päev** 09.12.2010
- (28) **Variantide arv** 2
- (72) **Autor** *Autorite andmeid ei avalikustata*
- (73) **Omanik** Scanfinest OÜ, Pärnu mnt 22a, 10141 Tallinn, EE
- (74) **Patendivolinik või ühine esindaja** Mart Enn Koppel

(51) Klass: **99-00**

(54) **Nimetus** **Ornament**

(55) **Reproduktsoon**

01311-01



01311-02



(11) Registreeringu number	01312	(51) Klass: 09-01
(21) Taotluse number	D200500081	
(15) Registreerimise päev	15.08.2007	
(22) Esitamise päev	09.12.2005	
(24) Registreeringu kehtivuse alguse päev	09.12.2005	
(18) Registreeringu kehtivuse lõppemise päev	09.12.2010	
(28) Variantide arv	2	
(72) Autor	<i>Autorite andmeid ei avalikustata</i>	
(73) Omanik	Scanfinest OÜ, Pärnu mnt 22a, 10141 Tallinn, EE	
(74) Patendivolinik või ühine esindaja	Mart Enn Koppel	

(54) Nimetus **Pudel**

(55) Reproduktsoon

01312-01



01312-02



(11) Registreeringu number	01313	(51) Klass: 09-01
(21) Taotluse number	D200500082	
(15) Registreerimise päev	15.08.2007	
(22) Esitamise päev	09.12.2005	
(24) Registreeringu kehtivuse alguse päev	09.12.2005	
(18) Registreeringu kehtivuse lõppemise päev	09.12.2010	
(28) Variantide arv	2	
(72) Autor	<i>Autorite andmeid ei avalikustata</i>	
(73) Omanik	Scanfinest OÜ, Pärnu mnt 22a, 10141 Tallinn, EE	
(74) Patendivolinik või ühine esindaja	Mart Enn Koppel	

(54) Nimetus **Pudel**

(55) Reproduktsoon

01313-01



01313-02



(11) Registreeringu number	01314	
(21) Taotluse number	D200500083	(51) Klass: 09-01
(15) Registreerimise päev	15.08.2007	
(22) Esitamise päev	09.12.2005	
(24) Registreeringu kehtivuse alguse päev	09.12.2005	
(18) Registreeringu kehtivuse lõppemise päev	09.12.2010	
(28) Variantide arv	2	
(72) Autor	<i>Autorite andmeid ei avalikustata</i>	
(73) Omanik	Scanfinest OÜ, Pärnu mnt 22a, 10141 Tallinn, EE	
(74) Patendivolinik või ühine esindaja	Mart Enn Koppel	

(54) Nimetus **Pudel**

(55) Reproduktsoon

01314-01



01314-02



(11) Registreeringu number	01315	(51) Klass: 09-01
(21) Taotluse number	D200500084	
(15) Registreerimise päev	15.08.2007	
(22) Esitamise päev	09.12.2005	
(24) Registreeringu kehtivuse alguse päev	09.12.2005	
(18) Registreeringu kehtivuse lõppemise päev	09.12.2010	
(28) Variantide arv	2	
(72) Autor	<i>Autorite andmeid ei avalikustata</i>	
(73) Omanik	Scanfinest OÜ, Pärnu mnt 22a, 10141 Tallinn, EE	
(74) Patendivolinik või ühine esindaja	Mart Enn Koppel	

(54) Nimetus **Pudel**

(55) Reproduktsoon

01315-01



01315-02



(11) Registreeringu number	01316	
(21) Taotluse number	D200500085	(51) Klass: 09-01
(15) Registreerimise päev	15.08.2007	
(22) Esitamise päev	09.12.2005	
(24) Registreeringu kehtivuse alguse päev	09.12.2005	
(18) Registreeringu kehtivuse lõppemise päev	09.12.2010	
(28) Variantide arv	2	
(72) Autor	<i>Autorite andmeid ei avalikustata</i>	
(73) Omanik	Scanfinest OÜ, Pärnu mnt 22a, 10141 Tallinn, EE	
(74) Patendivolinik või ühine esindaja	Mart Enn Koppel	

(54) Nimetus **Pudel**

(55) Reproduktsioon

01316-01



01316-02



(11) Registreeringu number	01317	(51) Klass: 09-01
(21) Taotluse number	D200500086	
(15) Registreerimise päev	15.08.2007	
(22) Esitamise päev	09.12.2005	
(24) Registreeringu kehtivuse alguse päev	09.12.2005	
(18) Registreeringu kehtivuse lõppemise päev	09.12.2010	
(28) Variantide arv	2	
(72) Autor	<i>Autorite andmeid ei avalikustata</i>	
(73) Omanik	Scanfinest OÜ, Pärnu mnt 22a, 10141 Tallinn, EE	
(74) Patendivolinik või ühine esindaja	Mart Enn Koppel	

(54) Nimetus **Pudel**

(55) Reproduktsoon

01317-01



01317-02



(11) Registreeringu number	01318	(51) Klass: 09-01
(21) Taotluse number	D200500087	
(15) Registreerimise päev	15.08.2007	
(22) Esitamise päev	09.12.2005	
(24) Registreeringu kehtivuse alguse päev	09.12.2005	
(18) Registreeringu kehtivuse lõppemise päev	09.12.2010	
(28) Variantide arv	2	
(72) Autor	<i>Autorite andmeid ei avalikustata</i>	
(73) Omanik	Scanfinest OÜ, Pärnu mnt 22a, 10141 Tallinn, EE	
(74) Patendivolinik või ühine esindaja	Mart Enn Koppel	

(54) Nimetus **Pudel**

(55) Reproduktsioon

01318-01



01318-02



(11) Registreeringu number	01319	(51) Klass: 09-01
(21) Taotluse number	D200600010	
(15) Registreerimise päev	15.08.2007	
(22) Esitamise päev	13.03.2006	
(24) Registreeringu kehtivuse alguse päev	13.03.2006	
(18) Registreeringu kehtivuse lõppemise päev	13.03.2011	
(28) Variantide arv	1	
(72) Autor	<i>Autorite andmeid ei avalikustata</i>	
(73) Omanik	Scanfinest OÜ, Pärnu mnt 22a, 10141 Tallinn, EE	
(74) Patendivolinik või ühine esindaja	Mart Enn Koppel	

(54) Nimetus **Pudel**

(55) Reproduksioon

01319-01



(11) **Registreeringu number** **01320**

(51) Klass: **11-02**

(21) **Taotluse number** D200700008

(15) **Registreerimise päev** 15.08.2007

(22) **Esitamise päev** 05.02.2007

(24) **Registreeringu kehtivuse alguse päev** 05.02.2007

(18) **Registreeringu kehtivuse lõppemise päev** 05.02.2012

(28) **Variantide arv** 1

(72) **Autor** *Autori andmeid ei avalikustata*

(73) **Omanik** Ingrid Nõmm, Koonga 5-11, Koonga vald, 88401 Pärnu maakond, EE

(54) **Nimetus** **Metallist roos**

(55) **Reproduktsoon**

01320-01



(11) Registreeringu number	01321	(51) Klass: 02-02
(21) Taotluse number	D200700009	
(15) Registreerimise päev	15.08.2007	
(22) Esitamise päev	08.02.2007	
(24) Registreeringu kehtivuse alguse päev	08.02.2007	
(18) Registreeringu kehtivuse lõppemise päev	08.02.2012	
(28) Variantide arv	2	
(72) Autor	Mari Lakspere, Kakumäe tee 257, 13516 Tallinn, EE	
(73) Omanik	Mari Lakspere, Kakumäe tee 257, 13516 Tallinn, EE	

(54) Nimetus **T-särk**

(55) Reproduktsoon

01321-01

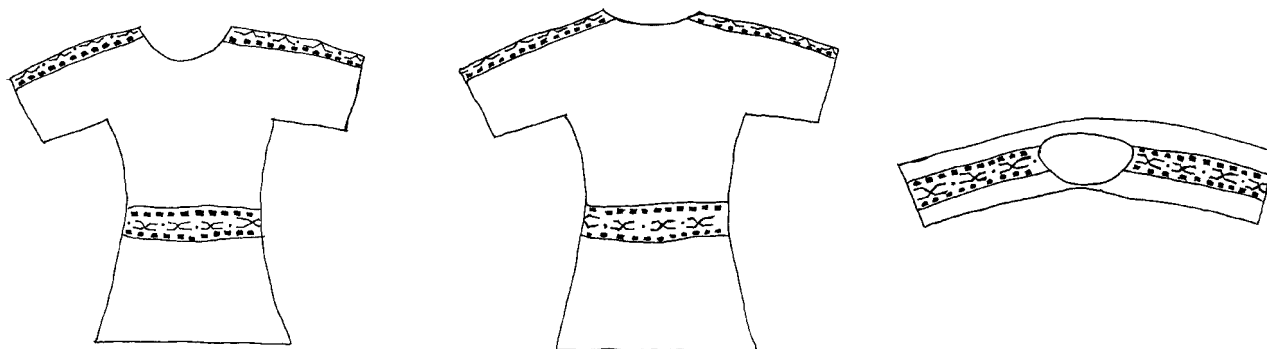

01321-02

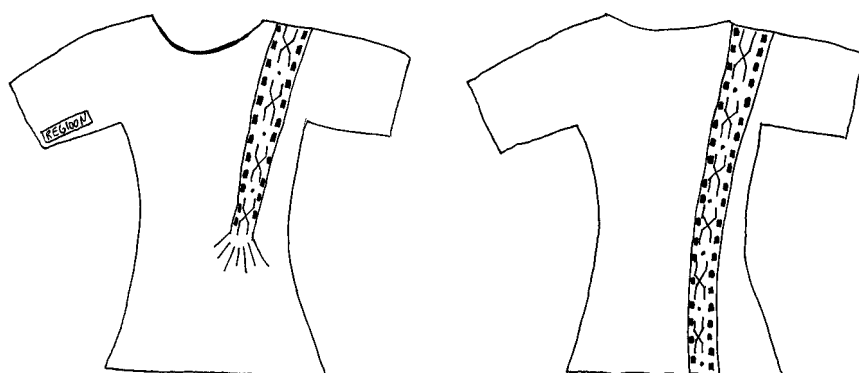

(11) **Registreeringu number** **01322**

(51) Klass: **06-06, 19-06**

(21) **Taotluse number** D200700018

(15) **Registreerimise päev** 15.08.2007

(22) **Esitamise päev** 15.03.2007

(24) **Registreeringu kehtivuse alguse päev** 15.03.2007

(18) **Registreeringu kehtivuse lõppemise päev** 15.03.2012

(28) **Variantide arv** 2

(72) **Autor** Peeter Leinbock, Endla 33, 71007 Viljandi, EE

(73) **Omanik** Peeter Leinbock, Endla 33, 71007 Viljandi, EE

(54) **Nimetus** **Skulptuurimodelleerimispukk**

(55) **Reproduksioon**

01322-01



01322-02



(11) Registreeringu number **01323**

(51) Klass: **06-06, 19-06**

(21) Taotluse number D200700019

(15) Registreerimise päev 15.08.2007

(22) Esitamise päev 15.03.2007

(24) Registreeringu kehtivuse alguse päev 15.03.2007

(18) Registreeringu kehtivuse lõppemise päev 15.03.2012

(28) Variantide arv 2

(72) Autor Peeter Leinbock, Endla 33, 71007 Viljandi, EE

(73) Omanik Peeter Leinbock, Endla 33, 71007 Viljandi, EE

(54) Nimetus **Skulptuurimodelleerimispukk**

(55) Reproduksioon

01323-01



01323-02



(11) Registreeringu number	01324
(21) Taotluse number	D200700020
(15) Registreerimise päev	15.08.2007
(22) Esitamise päev	15.03.2007
(24) Registreeringu kehtivuse alguse päev	15.03.2007
(18) Registreeringu kehtivuse lõppemise päev	15.03.2012
(28) Variantide arv	2
(72) Autor	Peeter Leinbock, Endla 33, 71007 Viljandi, EE
(73) Omanik	Peeter Leinbock, Endla 33, 71007 Viljandi, EE

(51) Klass: **08-10**(54) Nimetus **Jalgrataste hoidja**

(55) Reproduksioon

01324-01

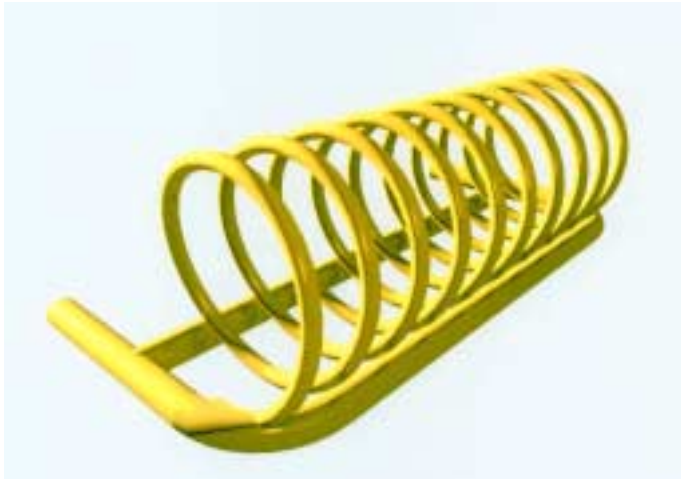

01324-02

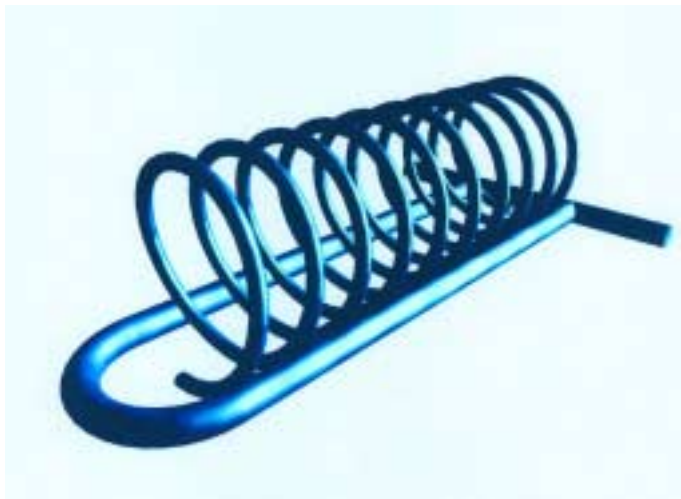

- (11) **Registreeringu number** **01325**
- (21) **Taotluse number** D200700024
- (15) **Registreerimise päev** 15.08.2007
- (22) **Esitamise päev** 27.03.2007
- (24) **Registreeringu kehtivuse alguse päev** 27.03.2007
- (18) **Registreeringu kehtivuse lõppemise päev** 27.03.2012
- (28) **Variantide arv** 1
- (72) **Autor** Peeter Pusa, Rahvakooli tee 12, 12015 Tallinn, EE
Ravo Talviste, Mõisa 8-40, Jüri, Rae vald, 75301 Harju maakond, EE
- (73) **Omanik** Peeter Pusa, Rahvakooli tee 12, 12015 Tallinn, EE
Ravo Talviste, Mõisa 8-40, Jüri, Rae vald, 75301 Harju maakond, EE
- (74) **Patendivolinik või ühine esindaja** Lembit Kalev
- (54) **Nimetus** **Lauamäng**
- (55) **Reproduktsoon**

01325-01



(11) **Registreeringu number** **01326**

(51) Klass: **14-03**

(21) **Taotluse number** D200700027

(15) **Registreerimise päev** 15.08.2007

(22) **Esitamise päev** 03.04.2007

(24) **Registreeringu kehtivuse alguse päev** 03.04.2007

(18) **Registreeringu kehtivuse lõppemise päev** 03.04.2012

(28) **Variantide arv** 1

(30) **Prioriteediandmed** M20060188, 09.10.2006, FI

(72) **Autor** Pertti Salmi, Sirppitie 30, 90530 Oulu, FI

Graham Hinde, Stephan Hannevinkellaan 15, 5673 MV Neuen, NL

Roger Swales, Pasteurlaan 71, 5644 JB Eindhoven, NL

Roland Bird, Julianastraat 7, 5611 HS Eindhoven, NL

(73) **Omanik** Nokia Corporation, Keilalahdentie 4, FIN-02150 Espoo, FI

(74) **Patendivolinik või ühine esindaja** Jüri Käosaar

(54) **Nimetus** **Käsitelefon**

(55) **Reproduksioon**

01326-01

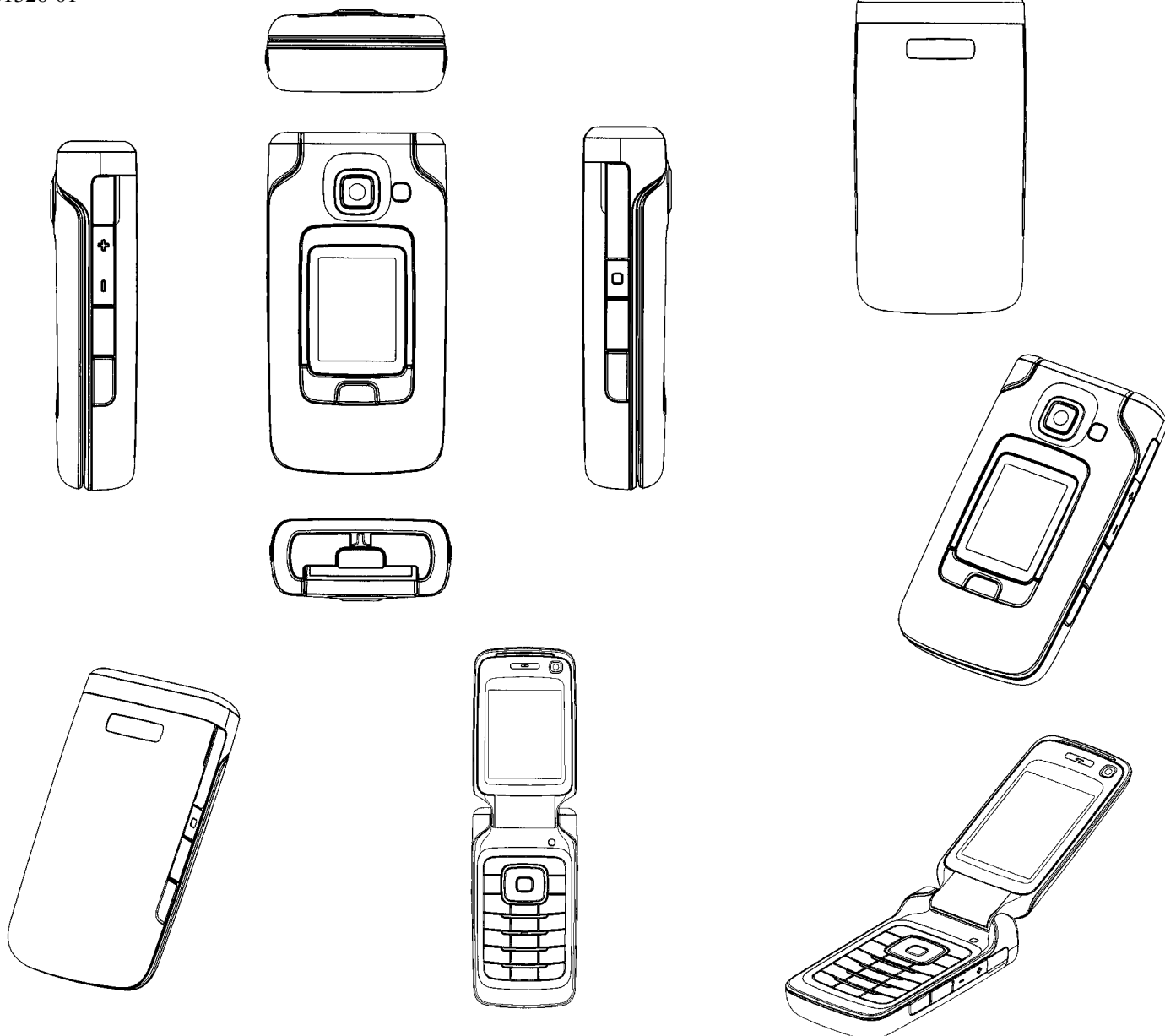

- (11) **Registreeringu number** **01327** (51) **Klass:** **23-03**
- (21) **Taotluse number** D200700032
- (15) **Registreerimise päev** 15.08.2007
- (22) **Esitamise päev** 13.04.2007
- (24) **Registreeringu kehtivuse alguse päev** 13.04.2007
- (18) **Registreeringu kehtivuse lõppemise päev** 13.04.2012
- (28) **Variantide arv** 1
- (72) **Autor** Toomas Raidna, Pärnamäe tee 155, Viimsi vald, 74001 Harju maakond, EE
- (73) **Omanik** OÜ Visari Metallitööd, Laki 11, 12915 Tallinn, EE

(54) **Nimetus** **Küpsetus-suitsutusahi**

(55) **Reproduktsoon**

01327-01

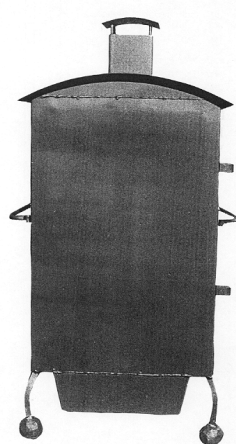
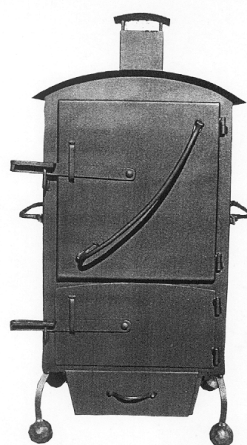
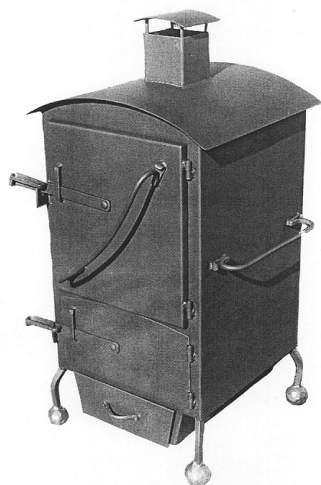

(11) Registreeringu number	01328	(51) Klass: 20-03
(21) Taotluse number	D200700035	
(15) Registreerimise päev	15.08.2007	
(22) Esitamise päev	30.04.2007	
(24) Registreeringu kehtivuse alguse päev	30.04.2007	
(18) Registreeringu kehtivuse lõppemise päev	30.04.2012	
(28) Variantide arv	5	
(72) Autor	Raul Suurhans, Lossi 20-5, 12616 Tallinn, EE	
(73) Omanik	Prisma Meedia OÜ, Paadi 14A-51, 10151 Tallinn, EE	
(74) Patendivolinik või ühine esindaja	Indrek Eelmets	

(54) Nimetus **Reklaamikandja**

(55) Reproduktsoon

01328-01

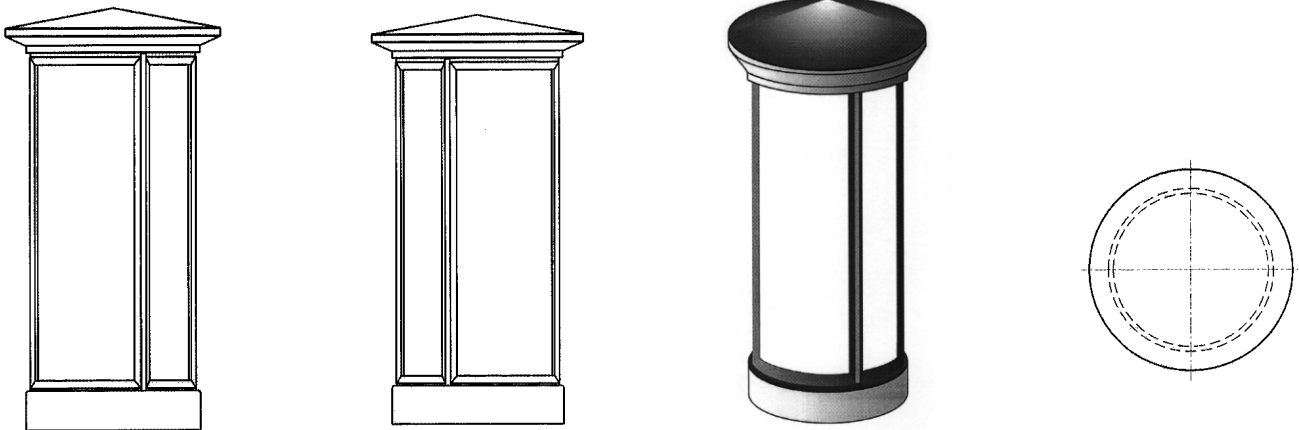

01328-02

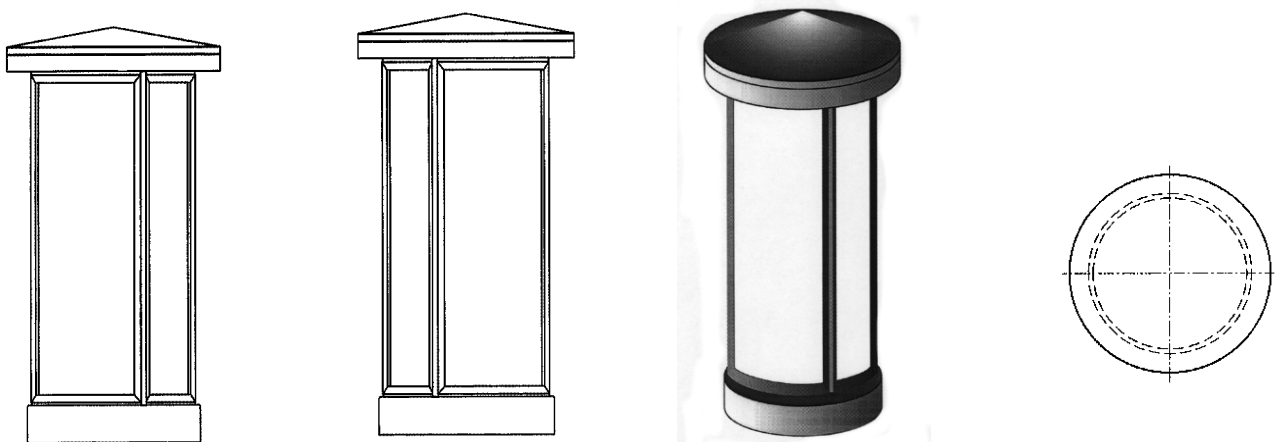

01328-03

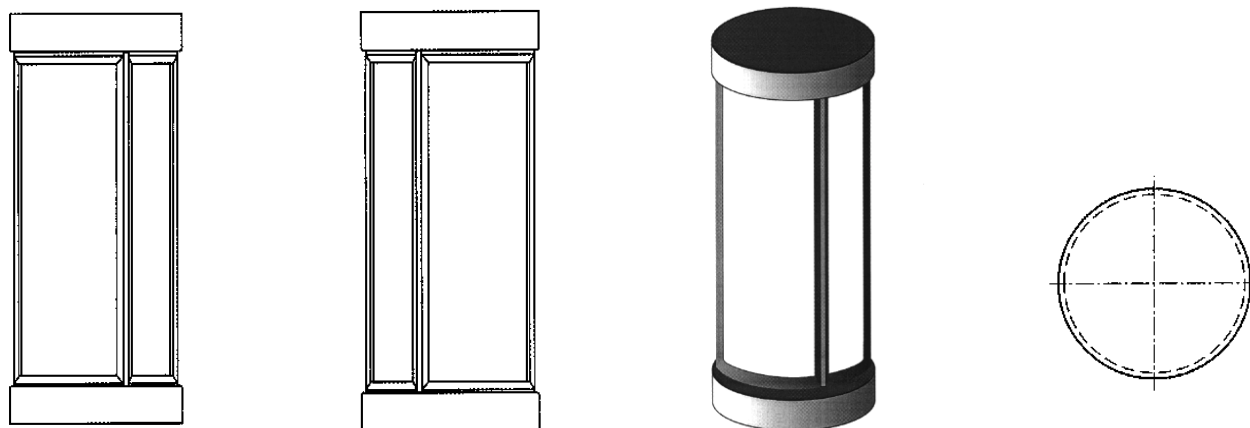

01328-04

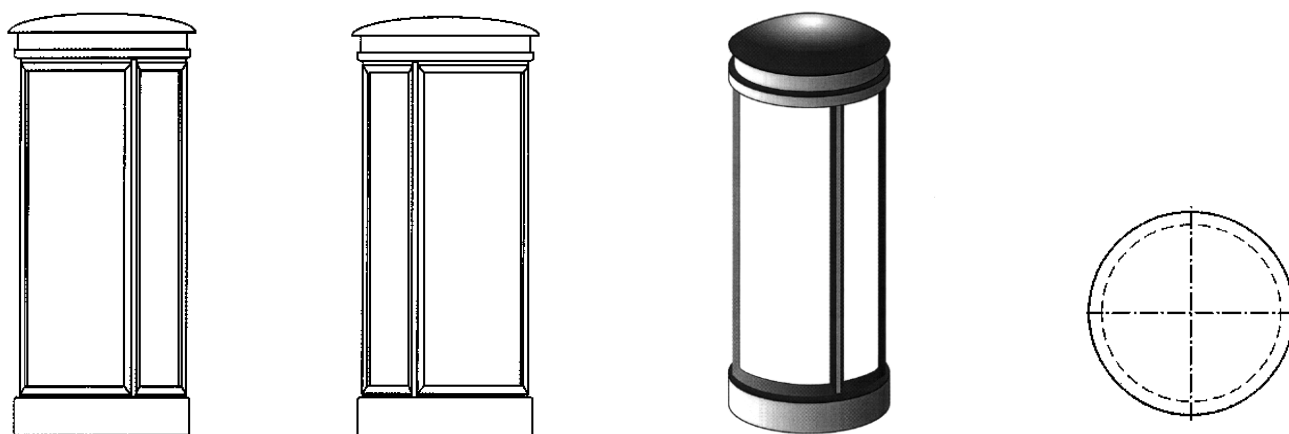

01328-05

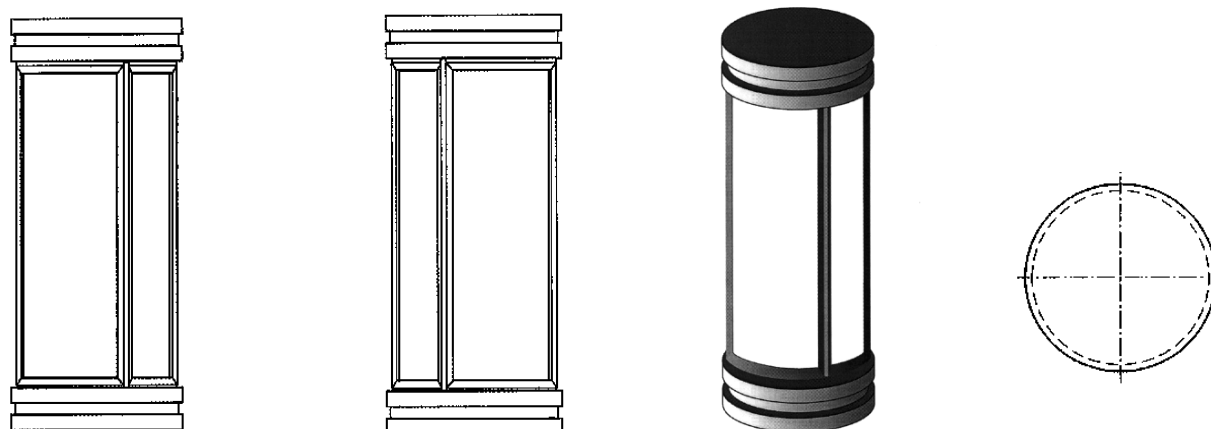

(11) **Registreeringu number** **01329**

(51) Klass: **09-03**

(21) **Taotluse number** D200700039

(15) **Registreerimise päev** 15.08.2007

(22) **Esitamise päev** 11.05.2007

(24) **Registreeringu kehtivuse
alguse päev** 11.05.2007

(18) **Registreeringu kehtivuse
lõppemise päev** 11.05.2012

(28) **Variantide arv** 1

(72) **Autor** *Autori andmeid ei avalikustata*

(73) **Omanik** Polimoon AS, Tehase 4, Rõngu, 61001 Tartu maakond, EE

(54) **Nimetus** **Plastkast**

(55) **Reproduksioon**

01329-01

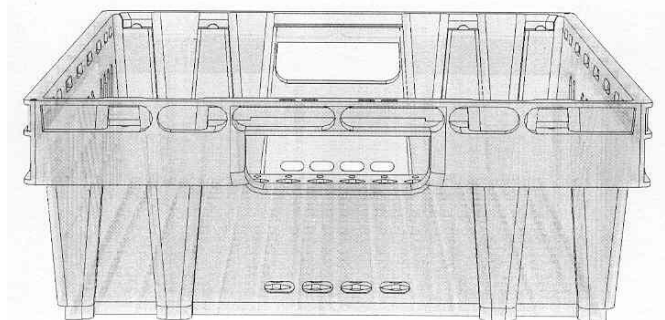
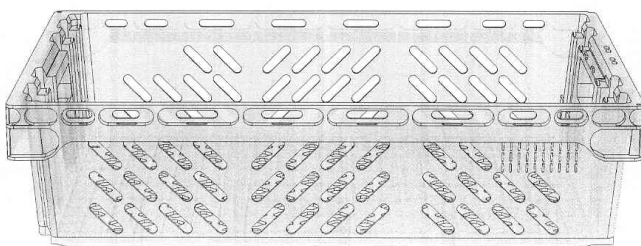
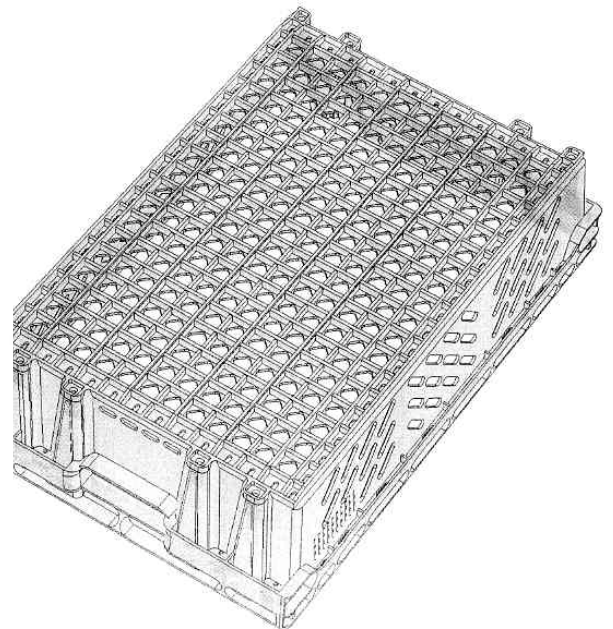
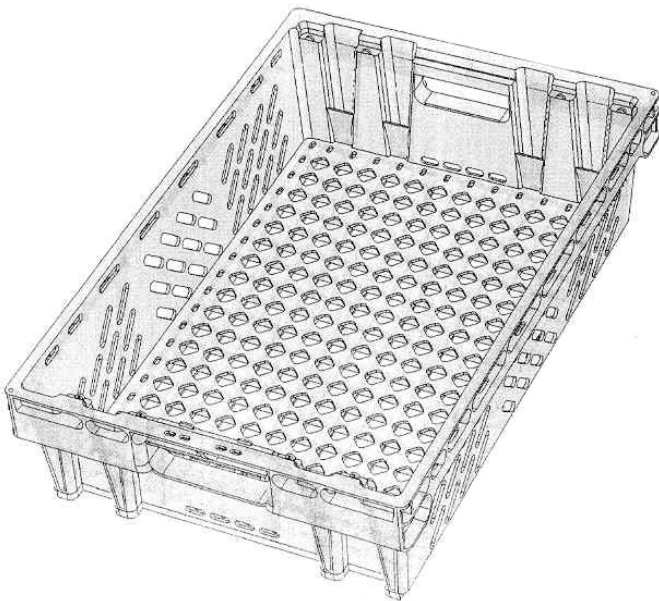

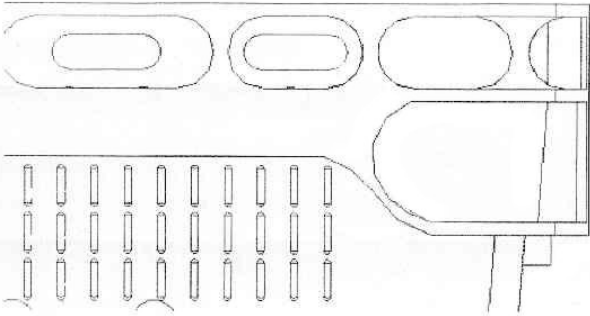
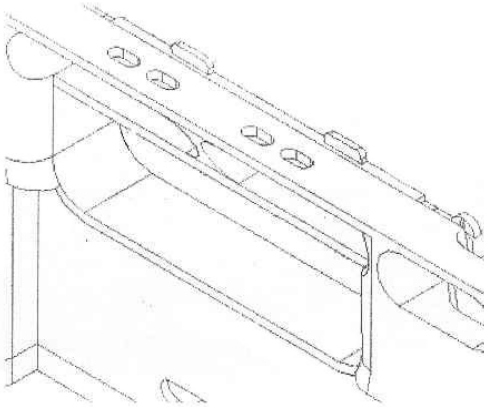
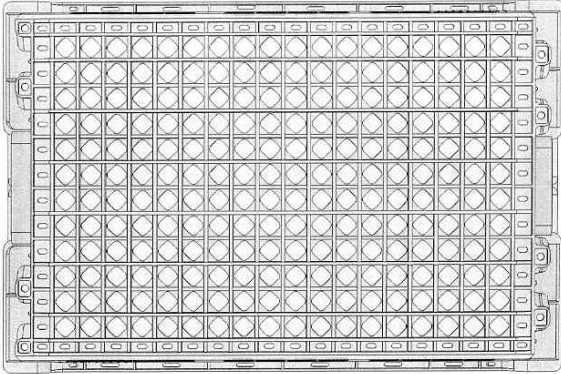
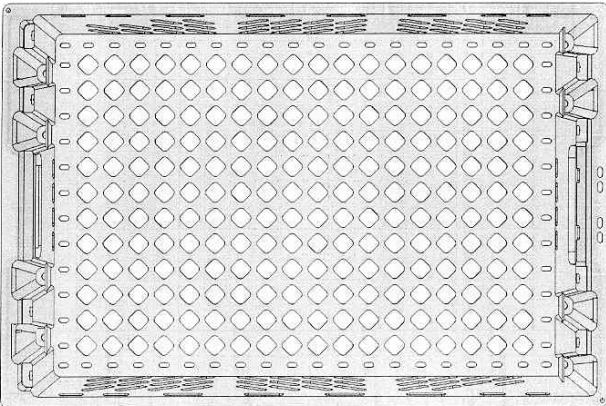

II. RAHVUSVAHELISELT REGISTREERITUD TÖÖSTUSDISAINILAHENDUSED

Avaldatakse "Tööstusdisaini kaitse seaduse" § 87⁴ lõike 3 alusel.

(11) Rahvusvah reg nr	DM/067891	(51) Klass: 09-03
(21) Rahvusvah reg jrk	H200600120	
(15) Registreeringu päev	05.05.2006	
(22) Esitamise päev	05.05.2006	
(28) Variantide arv	1	
(30) Prioriteediandmed	132516, 09.02.2006, CH	
(72) Autor	Jean Nouvel, 10, Cité d'Angoulême, F-75000 Paris, FR	
(73) Omanik	Société des Produits Nestlé S.A., 1800 Vevey, CH	
WIPO Rahvusvah Tööstusdisainilahenduste		
Bülletääni nr, kus registreering on avaldatud	2006/10	

(54) **Nimetus** **Box for chocolates**

(55) **Reproduksioon**

DM/067891-01

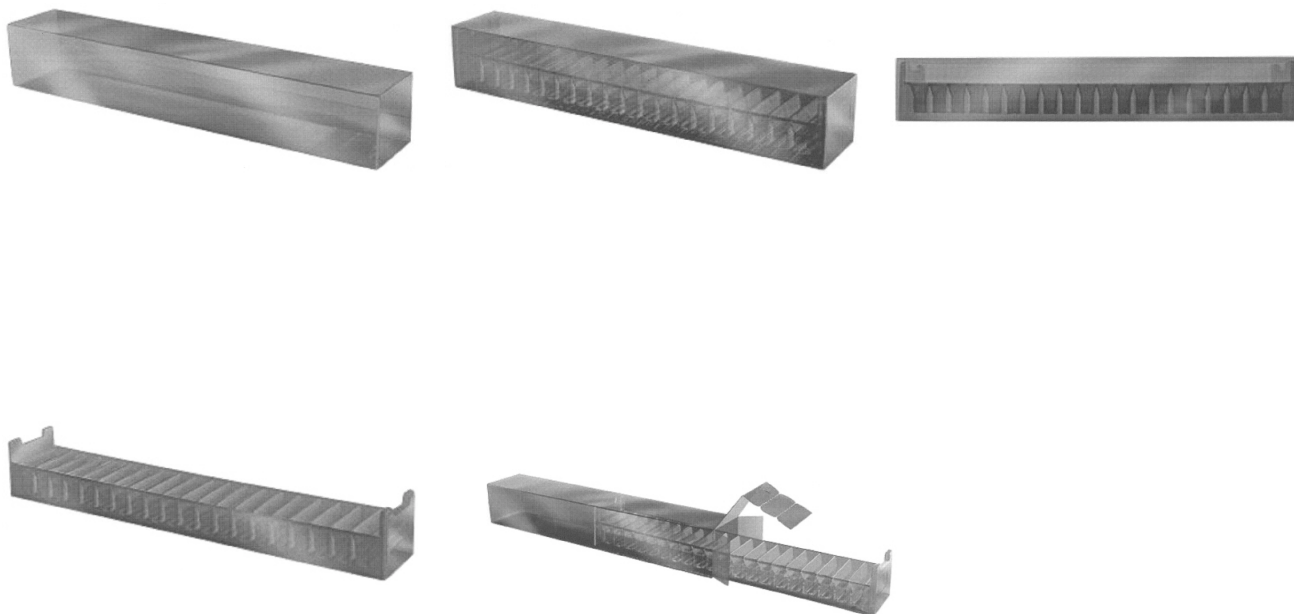

(11) **Rahvusvah reg nr****DM/067929**(51) Klass: **09-03**(21) **Rahvusvah reg jrk**

H200600128

(15) **Registreeringu päev**

13.06.2006

(22) **Esitamise päev**

13.06.2006

(28) **Variantide arv**

1

(30) **Prioriteediandmed**

000468558-0001, 25.01.2006, EM

(72) **Autor**

Sandro Quadrelli, Via d'Azeglio 71, 40123 Bologna, IT

(73) **Omanik**

Société des Produits Nestlé S.A., 1800 Vevey, CH

WIPO Rahvusvah Tööstusdisainilahenduste**Bülletääni nr, kus registreering on avaldatud** 2006/11(54) **Nimetus****Box for chocolates (packaging)**(55) **Reproduksioon**

DM/067929-01

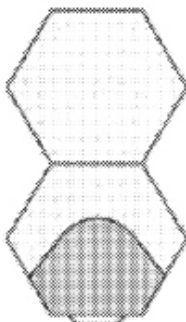
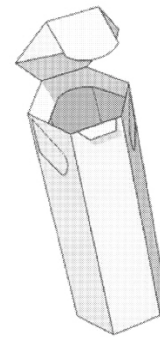
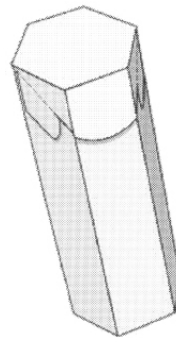
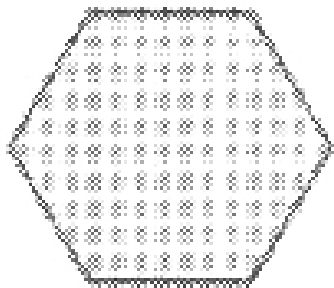
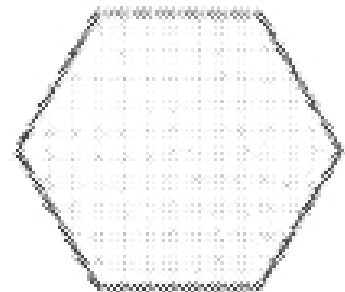
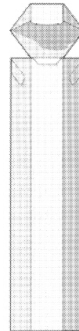
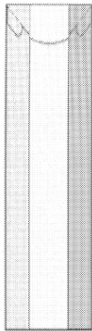

(11) Rahvusvah reg nr	DM/068195	(51) Klass: 11-01
(21) Rahvusvah reg jrk	H200600119	
(15) Registreeringu päev	13.10.2006	
(22) Esitamise päev	13.10.2006	
(28) Variantide arv	1	
(72) Autor	Arlette Elsa EMCH DUCOMMUN, rue des Mornets 31, CH-2520 LA NEUVEVILLE, CH	
(73) Omanik	THE SWATCH GROUP MANAGEMENT SERVICES AG (THE SWATCH GROUP MANAGEMENT SERVICES SA), (THE SWATCH GROUP MANAGEMENT SERVICES LTD.), Seevorstadt 6, CH-2502 BIENNE, CH	

**WIPO Rahvusvah Tööstusdisainilahenduste
Bülletääni nr, kus registreering on avaldatud** 2006/10

(54) **Nimetus** **Jewelry, including ring**

(55) **Reproduksioon**

DM/068195-01



(11) Rahvusvah reg nr	DM/068195	(51) Klass: 11-01
(21) Rahvusvah reg jrk	H200600119A	
(15) Registreeringu päev	13.10.2006	
(22) Esitamise päev	13.10.2006	
(28) Variantide arv	2	
(72) Autor	Arlette Elsa EMCH DUCOMMUN, rue des Mornets 31, CH-2520 LA NEUVEVILLE, CH	
(73) Omanik	THE SWATCH GROUP MANAGEMENT SERVICES AG (THE SWATCH GROUP MANAGEMENT SERVICES SA), (THE SWATCH GROUP MANAGEMENT SERVICES LTD.), Seevorstadt 6, CH-2502 BIENNE, CH	

**WIPO Rahvusvah Tööstusdisainilahenduste
Bülletääni nr, kus registreering on avaldatud** 2006/10

(54) **Nimetus** **Jewelry, including rings**
(55) **Reproduksioon**

DM/068195-01

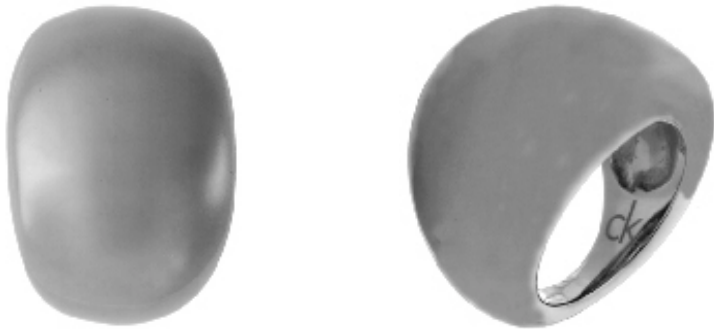

DM/068195-02



(11) Rahvusvah reg nr	DM/068195	(51) Klass: 11-01
(21) Rahvusvah reg jrk	H200600119B	
(15) Registreeringu päev	13.10.2006	
(22) Esitamise päev	13.10.2006	
(28) Variantide arv	1	
(72) Autor	Arlette Elsa EMCH DUCOMMUN, rue des Mornets 31, CH-2520 LA NEUVEVILLE, CH	
(73) Omanik	THE SWATCH GROUP MANAGEMENT SERVICES AG (THE SWATCH GROUP MANAGEMENT SERVICES SA), (THE SWATCH GROUP MANAGEMENT SERVICES LTD.), Seevorstadt 6, CH-2502 BIENNE, CH	

**WIPO Rahvusvah Tööstusdisainilahenduste
Bülletääni nr, kus registreering on avaldatud** 2006/10

(54) **Nimetus** **Jewelry, including ring**

(55) **Reproduksioon**

DM/068195-01



(11) Rahvusvah reg nr	DM/068195	(51) Klass: 11-01
(21) Rahvusvah reg jrk	H200600119C	
(15) Registreeringu päev	13.10.2006	
(22) Esitamise päev	13.10.2006	
(28) Variantide arv	3	
(72) Autor	Arlette Elsa EMCH DUCOMMUN, rue des Mornets 31, CH-2520 LA NEUVEVILLE, CH	
(73) Omanik	THE SWATCH GROUP MANAGEMENT SERVICES AG (THE SWATCH GROUP MANAGEMENT SERVICES SA), (THE SWATCH GROUP MANAGEMENT SERVICES LTD.), Seevorstadt 6, CH-2502 BIENNE, CH	

**WIPO Rahvusvah Tööstusdisainilahenduste
Bülletääni nr, kus registreering on avaldatud** 2006/10

(54) **Nimetus** **Jewelry, including bracelets**

(55) **Reproduktsoon**

DM/068195-01



DM/068195-02



DM/068195-03



(11) Rahvusvah reg nr	DM/068195	(51) Klass: 11-01
(21) Rahvusvah reg jrk	H200600119D	
(15) Registreeringu päev	13.10.2006	
(22) Esitamise päev	13.10.2006	
(28) Variantide arv	1	
(72) Autor	Arlette Elsa EMCH DUCOMMUN, rue des Mornets 31, CH-2520 LA NEUVEVILLE, CH	
(73) Omanik	THE SWATCH GROUP MANAGEMENT SERVICES AG (THE SWATCH GROUP MANAGEMENT SERVICES SA), (THE SWATCH GROUP MANAGEMENT SERVICES LTD.), Seevorstadt 6, CH-2502 BIENNE, CH	

**WIPO Rahvusvah Tööstusdisainilahenduste
Bülletääni nr, kus registreering on avaldatud** 2006/10

(54) **Nimetus** **Jewelry, including bracelet**

(55) **Reproduksioon**

DM/068195-01



(11) Rahvusvah reg nr	DM/068195	(51) Klass: 11-01
(21) Rahvusvah reg jrk	H200600119E	
(15) Registreeringu päev	13.10.2006	
(22) Esitamise päev	13.10.2006	
(28) Komplektide arv	1	
(72) Autor	Arlette Elsa EMCH DUCOMMUN, rue des Mornets 31, CH-2520 LA NEUVEVILLE, CH	
(73) Omanik	THE SWATCH GROUP MANAGEMENT SERVICES AG (THE SWATCH GROUP MANAGEMENT SERVICES SA), (THE SWATCH GROUP MANAGEMENT SERVICES LTD.), Seevorstadt 6, CH-2502 BIENNE, CH	

**WIPO Rahvusvah Tööstusdisainilahenduste
Bülletääni nr, kus registreering on avaldatud** 2006/10

(54) **Nimetus** **Jewelry, including bracelet, earrings**

(55) **Reproduksioon**

DM/068195-01



(11) Rahvusvah reg nr	DM/068195	(51) Klass: 11-01
(21) Rahvusvah reg jrk	H200600119F	
(15) Registreeringu päev	13.10.2006	
(22) Esitamise päev	13.10.2006	
(28) Komplektide arv	1	
(72) Autor	Arlette Elsa EMCH DUCOMMUN, rue des Mornets 31, CH-2520 LA NEUVEVILLE, CH	
(73) Omanik	THE SWATCH GROUP MANAGEMENT SERVICES AG (THE SWATCH GROUP MANAGEMENT SERVICES SA), (THE SWATCH GROUP MANAGEMENT SERVICES LTD.), Seevorstadt 6, CH-2502 BIENNE, CH	

**WIPO Rahvusvah Tööstusdisainilahenduste
Bülletääni nr, kus registreering on avaldatud** 2006/10

(54) **Nimetus** **Jewelry, including bracelet, necklace**

(55) **Reproduksioon**

DM/068195-01

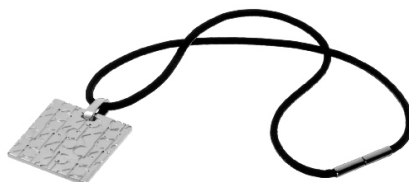
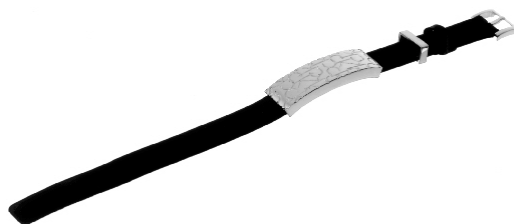

(11) Rahvusvah reg nr	DM/068195	(51) Klass: 11-01
(21) Rahvusvah reg jrk	H200600119G	
(15) Registreeringu päev	13.10.2006	
(22) Esitamise päev	13.10.2006	
(28) Variantide arv	1	
(72) Autor	Arlette Elsa EMCH DUCOMMUN, rue des Mornets 31, CH-2520 LA NEUVEVILLE, CH	
(73) Omanik	THE SWATCH GROUP MANAGEMENT SERVICES AG (THE SWATCH GROUP MANAGEMENT SERVICES SA), (THE SWATCH GROUP MANAGEMENT SERVICES LTD.), Seevorstadt 6, CH-2502 BIENNE, CH	

**WIPO Rahvusvah Tööstusdisainilahenduste
Bülletääni nr, kus registreering on avaldatud** 2006/10

(54) **Nimetus** **Jewelry, including necklace**

(55) **Reproduksioon**

DM/068195-01



(11) Rahvusvah reg nr	DM/068195	(51) Klass: 11-01
(21) Rahvusvah reg jrk	H200600119H	
(15) Registreeringu päev	13.10.2006	
(22) Esitamise päev	13.10.2006	
(28) Komplektide arv	1	
(72) Autor	Arlette Elsa EMCH DUCOMMUN, rue des Mornets 31, CH-2520 LA NEUVEVILLE, CH	
(73) Omanik	THE SWATCH GROUP MANAGEMENT SERVICES AG (THE SWATCH GROUP MANAGEMENT SERVICES SA), (THE SWATCH GROUP MANAGEMENT SERVICES LTD.), Seevorstadt 6, CH-2502 BIENNE, CH	

**WIPO Rahvusvah Tööstusdisainilahenduste
Bülletääni nr, kus registreering on avaldatud** 2006/10

(54) **Nimetus** **Jewelry, including necklace, earrings**

(55) **Reproduktsoon**

DM/068195-01



(11) Rahvusvah reg nr	DM/068195	(51) Klass: 11-01
(21) Rahvusvah reg jrk	H200600119I	
(15) Registreeringu päev	13.10.2006	
(22) Esitamise päev	13.10.2006	
(28) Variantide arv	1	
(72) Autor	Arlette Elsa EMCH DUCOMMUN, rue des Mornets 31, CH-2520 LA NEUVEVILLE, CH	
(73) Omanik	THE SWATCH GROUP MANAGEMENT SERVICES AG (THE SWATCH GROUP MANAGEMENT SERVICES SA), (THE SWATCH GROUP MANAGEMENT SERVICES LTD.), Seevorstadt 6, CH-2502 BIENNE, CH	

**WIPO Rahvusvah Tööstusdisainilahenduste
Bülletääni nr, kus registreering on avaldatud** 2006/10

(54) **Nimetus** **Jewelry, including earrings**

(55) **Reproduksioon**

DM/068195-01



(11) Rahvusvah reg nr	DM/068196	(51) Klass: 10-02
(21) Rahvusvah reg jrk	H200600118	
(15) Registreeringu päev	13.10.2006	
(22) Esitamise päev	13.10.2006	
(28) Variantide arv	1	
(72) Autor	Marco DRAGOTTA, SWATCHLAB, Via Archimede, 6, I-20129 MILANO, IT	
(73) Omanik	SWATCH AG (SWATCH SA) (SWATCH LTD.), 94, Rue Jakob Stämpfli, CH-2502 BIENNE, CH	
WIPO Rahvusvah Tööstusdisainilahenduste Bülletääni nr, kus registreering on avaldatud	2006/10	

(54) **Nimetus** **Wristwatch**

(55) **Reproduksioon**

DM/068196-01



(11) Rahvusvah reg nr	DM/068203	(51) Klass: 10-02
(21) Rahvusvah reg jrk	H200600117	
(15) Registreeringu päev	10.10.2006	
(22) Esitamise päev	10.10.2006	
(28) Variantide arv	1	
(72) Autor	KIM SANG HUN, c/o Changeun Lee, 2F, 474-8, Seogyo-Dong, MAPO-GU, KR-121-842 SEOUL, KR	
(73) Omanik	SWATCH AG (SWATCH SA) (SWATCH LTD.), 94, Rue Jakob Stämpfli, CH-2502 BIENNE, CH	

WIPO Rahvusvah Tööstusdisainilahenduste
Bülletääni nr, kus registreering on avaldatud 2006/10

(54) **Nimetus** **Wristwatch**

(55) **Reproduksioon**

DM/068203-01



(11) Rahvusvah reg nr	DM/068209	(51) Klass: 10-02
(21) Rahvusvah reg jrk	H200600116	
(15) Registreeringu päev	10.10.2006	
(22) Esitamise päev	10.10.2006	
(28) Variantide arv	1	
(72) Autor	Alexandra FIGUEIREDO, SWATCH SA, 94, rue Jacob Stämpfli, CH-2502 BIENNE, CH	
(73) Omanik	SWATCH AG (SWATCH SA) (SWATCH LTD.), 94, Rue Jakob Stämpfli, CH-2502 BIENNE, CH	
WIPO Rahvusvah Tööstusdisainilahenduste Bülletääni nr, kus registreering on avaldatud	2006/10	

(54) **Nimetus** **Wristwatch**

(55) **Reproduksioon**

DM/068209-01



(11) Rahvusvah reg nr	DM/068217	(51) Klass: 10-07
(21) Rahvusvah reg jrk	H200600115	
(15) Registreeringu päev	03.10.2006	
(22) Esitamise päev	03.10.2006	
(28) Variantide arv	1	
(72) Autor	Hakim EL KADIRI, Rue de Neuchâtel, CH-2072 ST-BLAISE, CH	
(73) Omanik	ENDURA AG (ENDURA SA)(ENDURA LTD.), Längfeldweg 119, CH-2504 Biel-Bienne, CH	

WIPO Rahvusvah Tööstusdisainilahenduste
Bülletääni nr, kus registreering on avaldatud 2006/10

(54) **Nimetus** **Watch case**

(55) **Reproduktsoon**

DM/068217-01



(11) Rahvusvah reg nr	DM/068224	(51) Klass: 09-01
(21) Rahvusvah reg jrk	H200600114	
(15) Registreeringu päev	16.06.2006	
(22) Esitamise päev	16.06.2006	
(28) Variantide arv	1	
(30) Prioriteediandmed	D 06 00053, 15.02.2006, HU	
(72) Autor	Ferenc TAKÁCS, Jókai út 41, H-2092 Budakeszi, HU	
(73) Omanik	FERENC TAKÁCS, Jókai út 41, H-2092 Budakeszi, HU	
WIPO Rahvusvah Tööstusdisainilahenduste Bülletääni nr, kus registreering on avaldatud	2006/10	

(54) **Nimetus** **Body of a honey bottle**

(55) **Reproduktsoon**

DM/068224-01

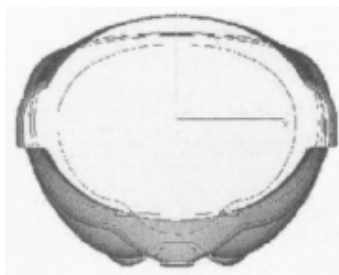
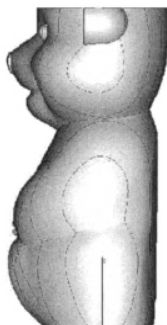
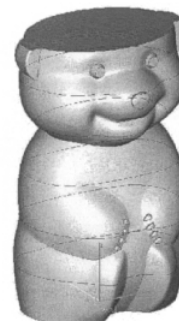
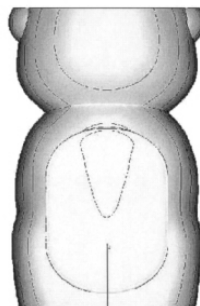
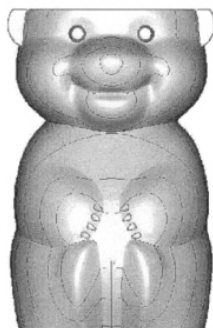

(11) Rahvusvah reg nr	DM/068229	(51) Klass: 10-07
(21) Rahvusvah reg jrk	H200600113	
(15) Registreeringu päev	28.09.2006	
(22) Esitamise päev	28.09.2006	
(28) Variantide arv	1	
(72) Autor	Rossana BOFFI, SWATCHLAB, Via Archimede, 6, I-20129 MILANO, IT	
(73) Omanik	SWATCH AG (SWATCH SA) (SWATCH LTD.), 94, Rue Jakob Stämpfli, CH-2502 BIENNE, CH	

WIPO Rahvusvah Tööstusdisainilahenduste
Bülletääni nr, kus registreering on avaldatud 2006/10

(54) **Nimetus** **Watch bracelet**

(55) **Reproduktsoon**

DM/068229-01



(11) Rahvusvah reg nr	DM/068251	(51) Klass: 10-07
(21) Rahvusvah reg jrk	H200600112	
(15) Registreeringu päev	20.10.2006	
(22) Esitamise päev	20.10.2006	
(28) Variantide arv	1	
(72) Autor	Marco DRAGOTTA, SWATCHLAB, Via Archimede, 6, I-20129 MILANO, IT	
(73) Omanik	SWATCH AG (SWATCH SA) (SWATCH LTD.), 94, Rue Jakob Stämpfli, CH-2502 BIENNE, CH	
WIPO Rahvusvah Tööstusdisainilahenduste Bülletääni nr, kus registreering on avaldatud	2006/10	

(54) **Nimetus** **Watch bracelet**

(55) **Reproduktsoon**

DM/068251-01



(11) Rahvusvah reg nr	DM/068254	(51) Klass: 10-02
(21) Rahvusvah reg jrk	H200600111	
(15) Registreeringu päev	20.10.2006	
(22) Esitamise päev	20.10.2006	
(28) Variantide arv	1	
(72) Autor	Stephane AVRENCHEs, BLADE DESIGN, 14, chemin du Pré-Fleuri, PLAN-LES Ouates, CH-1228 GENEVE, CH	
(73) Omanik	SWATCH AG (SWATCH SA) (SWATCH LTD.), 94, Rue Jakob Stämpfli, CH-2502 BIENNE, CH	

**WIPO Rahvusvah Tööstusdisainilahenduste
Bülletääni nr, kus registreering on avaldatud** 2006/10

(54) **Nimetus** **Wristwatch**

(55) **Reproduktsoon**

DM/068254-01



(11) Rahvusvah reg nr	DM/068255	(51) Klass: 10-02
(21) Rahvusvah reg jrk	H200600110	
(15) Registreeringu päev	20.10.2006	
(22) Esitamise päev	20.10.2006	
(28) Variantide arv	1	
(72) Autor	Rossana BOFFI, SWATCHLAB, Via Archimede, 6, I-20129 MILANO, IT	
(73) Omanik	SWATCH AG (SWATCH SA) (SWATCH LTD.), 94, Rue Jakob Stämpfli, CH-2502 BIENNE, CH	
WIPO Rahvusvah Tööstusdisainilahenduste Bülletääni nr, kus registreering on avaldatud	2006/10	

(54) **Nimetus** **Wristwatch**

(55) **Reproduksioon**

DM/068255-01



(11) Rahvusvah reg nr	DM/068257	(51) Klass: 10-02
(21) Rahvusvah reg jrk	H200600109	
(15) Registreeringu päev	20.10.2006	
(22) Esitamise päev	20.10.2006	
(28) Variantide arv	1	
(72) Autor	Andrea Arrigoni, SWATCHLAB, Via Archimede, 6, I-20129 MILANO, IT	
(73) Omanik	SWATCH AG (SWATCH SA) (SWATCH LTD.), 94, Rue Jakob Stämpfli, CH-2502 BIENNE, CH	

**WIPO Rahvusvah Tööstusdisainilahenduste
Bülletääni nr, kus registreering on avaldatud** 2006/10

(54) **Nimetus** **Wristwatch**

(55) **Reproduksioon**

DM/068257-01



(11) Rahvusvah reg nr	DM/068258	(51) Klass: 10-02
(21) Rahvusvah reg jrk	H200600108	
(15) Registreeringu päev	20.10.2006	
(22) Esitamise päev	20.10.2006	
(28) Variantide arv	1	
(72) Autor	Alexandra FIGUEIREDO, SWATCH SA, 94, rue Jacob Stämpfli, CH-2502 BIENNE, CH	
(73) Omanik	SWATCH AG (SWATCH SA) (SWATCH LTD.), 94, Rue Jakob Stämpfli, CH-2502 BIENNE, CH	
WIPO Rahvusvah Tööstusdisainilahenduste Bülletääni nr, kus registreering on avaldatud	2006/10	

(54) **Nimetus** **Wristwatch**

(55) **Reproduksioon**

DM/068258-01



(11) Rahvusvah reg nr	DM/068275	(51) Klass: 10-02
(21) Rahvusvah reg jrk	H200600107	
(15) Registreeringu päev	10.10.2006	
(22) Esitamise päev	10.10.2006	
(28) Variantide arv	1	
(72) Autor	Lorenzo VALLONE, SWATCHLAB, Via Archimede 6, I-20129 MILANO, IT	
(73) Omanik	SWATCH AG (SWATCH SA) (SWATCH LTD.), 94, Rue Jakob Stämpfli, CH-2502 BIENNE, CH	

**WIPO Rahvusvah Tööstusdisainilahenduste
Bülletääni nr, kus registreering on avaldatud** 2006/10

(54) **Nimetus** **Wristwatch**

(55) **Reproduksioon**

DM/068275-01



(11) Rahvusvah reg nr	DM/068277	(51) Klass: 10-02
(21) Rahvusvah reg jrk	H200600106	
(15) Registreeringu päev	10.10.2006	
(22) Esitamise päev	10.10.2006	
(28) Variantide arv	1	
(72) Autor	Claudia CANNONE, SWATCHLAB, Via Archimede 6, I-20129 MILANO, IT	
(73) Omanik	SWATCH AG (SWATCH SA) (SWATCH LTD.), 94, Rue Jakob Stämpfli, CH-2502 BIENNE, CH	
WIPO Rahvusvah Tööstusdisainilahenduste Bülletääni nr, kus registreering on avaldatud	2006/10	

(54) **Nimetus** **Wristwatch**

(55) **Reproduksioon**

DM/068277-01



(11) Rahvusvah reg nr	DM/068278	(51) Klass: 10-02
(21) Rahvusvah reg jrk	H200600105	
(15) Registreeringu päev	10.10.2006	
(22) Esitamise päev	10.10.2006	
(28) Variantide arv	1	
(72) Autor	Walter GARRO, SWATCHLAB, Via Archimede 6, I-20129 MILANO, IT	
(73) Omanik	SWATCH AG (SWATCH SA) (SWATCH LTD.), 94, Rue Jakob Stämpfli, CH-2502 BIENNE, CH	
WIPO Rahvusvah Tööstusdisainilahenduste Bülletääni nr, kus registreering on avaldatud	2006/10	

(54) **Nimetus** **Wristwatch**

(55) **Reproduktsoon**

DM/068278-01



- (11) **Rahvusvah reg nr** DM/068303 (51) Klass: **10-02**
- (21) **Rahvusvah reg jrk** H200600127
- (15) **Registreeringu päev** 15.11.2006
- (22) **Esitamise päev** 15.11.2006
- (28) **Variantide arv** 1
- (72) **Autor** Adelina BISSOLO, SWATCHLAB, Via Archimede 6,
IT-20129 MILANO, IT
- (73) **Omanik** SWATCH AG (SWATCH SA) (SWATCH LTD.), 94, Rue Jakob Stämpfli,
CH-2502 BIENNE, CH

**WIPO Rahvusvah Tööstusdisainilahenduste
Bülletääni nr, kus registreering on avaldatud** 2006/11

(54) **Nimetus** Watch

(55) **Reproduksioon**

DM/068303-01



(11) Rahvusvah reg nr	DM/068304	(51) Klass: 10-02
(21) Rahvusvah reg jrk	H200600126	
(15) Registreeringu päev	07.11.2006	
(22) Esitamise päev	07.11.2006	
(28) Variantide arv	1	
(72) Autor	Damien GOYET, CDPN-A division of the Swatch Group Management Services Ltd., Schützenstrasse 30, CH-2540 GRENCHEN, CH	
(73) Omanik	SWATCH AG (SWATCH SA) (SWATCH LTD.), 94, Rue Jakob Stämpfli, CH-2502 BIENNE, CH	

**WIPO Rahvusvah Tööstusdisainilahenduste
Bülletääni nr, kus registreering on avaldatud** 2006/11

(54) **Nimetus** **Wristwatch**

(55) **Reproduksioon**

DM/068304-01



(11) Rahvusvah reg nr	DM/068317	(51) Klass: 10-02
(21) Rahvusvah reg jrk	H200600125	
(15) Registreeringu päev	31.10.2006	
(22) Esitamise päev	31.10.2006	
(28) Variantide arv	1	
(72) Autor	Rossana BOFFI, SWATCHLAB, Via Archimede, 6, I-20129 MILANO, IT	
(73) Omanik	SWATCH AG (SWATCH SA) (SWATCH LTD.), 94, Rue Jakob Stämpfli, CH-2502 BIENNE, CH	
WIPO Rahvusvah Tööstusdisainilahenduste Bülletääni nr, kus registreering on avaldatud	2006/11	

(54) **Nimetus** **Wristwatch**

(55) **Reproduktsoon**

DM/068317-01



(11) Rahvusvah reg nr	DM/068323	(51) Klass: 10-02
(21) Rahvusvah reg jrk	H200600124	
(15) Registreeringu päev	07.11.2006	
(22) Esitamise päev	07.11.2006	
(28) Variantide arv	1	
(72) Autor	Marco DRAGOTTA, SWATCHLAB, Via Archimede, 6, I-20129 MILANO, IT	
(73) Omanik	SWATCH AG (SWATCH SA) (SWATCH LTD.), 94, Rue Jakob Stämpfli, CH-2502 BIENNE, CH	

**WIPO Rahvusvah Tööstusdisainilahenduste
Bülletääni nr, kus registreering on avaldatud** 2006/11

(54) **Nimetus** **Wristwatch**

(55) **Reproduksioon**

DM/068323-01



(11) Rahvusvah reg nr	DM/068341	(51) Klass: 21-03
(21) Rahvusvah reg jrk	H200700001	
(15) Registreeringu päev	28.07.2006	
(22) Esitamise päev	28.07.2006	
(28) Variantide arv	1	
(30) Prioriteediandmed	000470349-0001, 30.01.2006, EM	
(72) Autor	Félix GUINDULAIN BUSTO, Cañada nº 2, E-31350 PERALTA (Navarra), ES	
(73) Omanik	JOFEMAR, S.A., Ctra. Marcilla, Km. 2, E-31350 PERALTA (Navarra), ES	
WIPO Rahvusvah Tööstusdisainilahenduste Bülletääni nr, kus registreering on avaldatud	2006/12	

(54) **Nimetus** **Automatic machine for games of chance**

(55) **Reproduksioon**

DM/068341-01

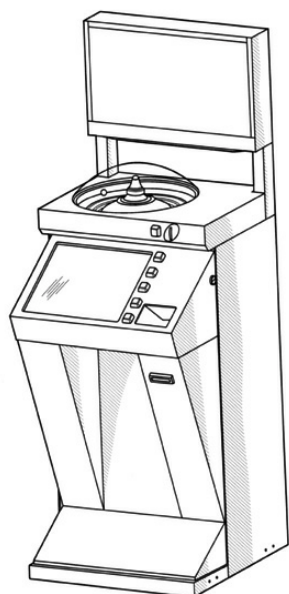

(11) **Rahvusvah reg nr**

DM/068348

(51) Klass: **11-01**(21) **Rahvusvah reg jrk**

H200600123

(15) **Registreeringu päev**

31.10.2006

(22) **Esitamise päev**

31.10.2006

(28) **Komplektide arv**

1

(72) **Autor**EMCH DUCOMMUN Arlette Elsa, rue des Mornets 31,
CH-2520 LA NEUVILLE, CH(73) **Omanik**LÉON HATOT SA (LÉON HATOT AG) (LÉON HATOT LTD.),
Viaduktstrasse 30, CH-2500 BIEL/BIENNE, CH**WIPO Rahvusvah Tööstusdisainilahenduste
Bülletääni nr, kus registreering on avaldatud**

2006/11

(54) **Nimetus****Jewelry, including necklace, pendants, ring, earrings**(55) **Reproduktsoon**

DM/068348-01

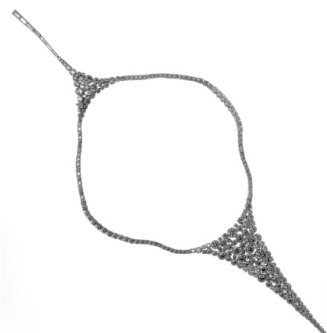



(11) Rahvusvah reg nr	DM/068359	(51) Klass: 10-02
(21) Rahvusvah reg jrk	H200600122	
(15) Registreeringu päev	31.10.2006	
(22) Esitamise päev	31.10.2006	
(28) Variantide arv	1	
(72) Autor	Walter GARRO, SWATCHLAB, Via Archimede 6, I-20129 MILANO, IT	
(73) Omanik	SWATCH AG (SWATCH SA) (SWATCH LTD.), 94, Rue Jakob Stämpfli, CH-2502 BIENNE, CH	
WIPO Rahvusvah Tööstusdisainilahenduste Bülletääni nr, kus registreering on avaldatud	2006/11	

(54) **Nimetus** **Wristwatch**

(55) **Reproduktsoon**

DM/068359-01



(11) Rahvusvah reg nr	DM/068361	(51) Klass: 10-02
(21) Rahvusvah reg jrk	H200600121	
(15) Registreeringu päev	31.10.2006	
(22) Esitamise päev	31.10.2006	
(28) Variantide arv	1	
(72) Autor	Adelina BISSOLO, SWATCHLAB, Via Archimede 6, IT-20129 MILANO, IT	
(73) Omanik	SWATCH AG (SWATCH SA) (SWATCH LTD.), 94, Rue Jakob Stämpfli, CH-2502 BIENNE, CH	
WIPO Rahvusvah Tööstusdisainilahenduste Bülletääni nr, kus registreering on avaldatud	2006/11	

(54) **Nimetus** **Wristwatch**

(55) **Reproduktsoon**

DM/068361-01



(11) Rahvusvah reg nr	DM/068400	(51) Klass: 11-01
(21) Rahvusvah reg jrk	H200700002	
(15) Registreeringu päev	08.12.2006	
(22) Esitamise päev	08.12.2006	
(28) Variantide arv	2	
(72) Autor	Arlette Elsa EMCH DUCOMMUN, Rue des Mornets 31, CH-2520 LA NEUVEVILLE, CH	
(73) Omanik	THE SWATCH GROUP MANAGEMENT SERVICES AG (THE SWATCH GROUP MANAGEMENT SERVICES SA), (THE SWATCH GROUP MANAGEMENT SERVICES LTD.), Seevorstadt 6, CH-2502 BIENNE, CH	

**WIPO Rahvusvah Tööstusdisainilahenduste
Bülletääni nr, kus registreering on avaldatud** 2006/12

(54) **Nimetus** **Jewelry, particularly rings**

(55) **Reproduksioon**

DM/068400-01



DM/068400-02



(11) Rahvusvah reg nr	DM/068400	(51) Klass: 11-01
(21) Rahvusvah reg jrk	H200700002A	
(15) Registreeringu päev	08.12.2006	
(22) Esitamise päev	08.12.2006	
(28) Variantide arv	1	
(72) Autor	Arlette Elsa EMCH DUCOMMUN, Rue des Mornets 31, CH-2520 LA NEUVEVILLE, CH	
(73) Omanik	THE SWATCH GROUP MANAGEMENT SERVICES AG (THE SWATCH GROUP MANAGEMENT SERVICES SA), (THE SWATCH GROUP MANAGEMENT SERVICES LTD.), Seevorstadt 6, CH-2502 BIENNE, CH	

**WIPO Rahvusvah Tööstusdisainilahenduste
Bülletääni nr, kus registreering on avaldatud** 2006/12

(54) **Nimetus** **Jewelry, particularly pendant**

(55) **Reproduksioon**

DM/068400-01



(11) Rahvusvah reg nr	DM/068400	(51) Klass: 11-01
(21) Rahvusvah reg jrk	H200700002B	
(15) Registreeringu päev	08.12.2006	
(22) Esitamise päev	08.12.2006	
(28) Variantide arv	2	
(72) Autor	Arlette Elsa EMCH DUCOMMUN, Rue des Mornets 31, CH-2520 LA NEUVEVILLE, CH	
(73) Omanik	THE SWATCH GROUP MANAGEMENT SERVICES AG (THE SWATCH GROUP MANAGEMENT SERVICES SA), (THE SWATCH GROUP MANAGEMENT SERVICES LTD.), Seevorstadt 6, CH-2502 BIENNE, CH	

**WIPO Rahvusvah Tööstusdisainilahenduste
Bülletääni nr, kus registreering on avaldatud** 2006/12

(54) **Nimetus** **Jewelry, particularly pendants**

(55) **Reproduksioon**

DM/068400-01



DM/068400-02



(11) Rahvusvah reg nr	DM/068400	(51) Klass: 11-01
(21) Rahvusvah reg jrk	H200700002C	
(15) Registreeringu päev	08.12.2006	
(22) Esitamise päev	08.12.2006	
(28) Variantide arv	3	
(72) Autor	Arlette Elsa EMCH DUCOMMUN, Rue des Mornets 31, CH-2520 LA NEUVEVILLE, CH	
(73) Omanik	THE SWATCH GROUP MANAGEMENT SERVICES AG (THE SWATCH GROUP MANAGEMENT SERVICES SA), (THE SWATCH GROUP MANAGEMENT SERVICES LTD.), Seevorstadt 6, CH-2502 BIENNE, CH	

**WIPO Rahvusvah Tööstusdisainilahenduste
Bülletääni nr, kus registreering on avaldatud** 2006/12

(54) **Nimetus** **Jewelry, particularly pendants**

(55) **Reproduktsoon**

DM/068400-01



DM/068400-02



DM/068400-03



(11) Rahvusvah reg nr	DM/068400	(51) Klass: 11-01
(21) Rahvusvah reg jrk	H200700002D	
(15) Registreeringu päev	08.12.2006	
(22) Esitamise päev	08.12.2006	
(28) Variantide arv	1	
(72) Autor	Arlette Elsa EMCH DUCOMMUN, Rue des Mornets 31, CH-2520 LA NEUVEVILLE, CH	
(73) Omanik	THE SWATCH GROUP MANAGEMENT SERVICES AG (THE SWATCH GROUP MANAGEMENT SERVICES SA), (THE SWATCH GROUP MANAGEMENT SERVICES LTD.), Seevorstadt 6, CH-2502 BIENNE, CH	

**WIPO Rahvusvah Tööstusdisainilahenduste
Bülletääni nr, kus registreering on avaldatud** 2006/12

(54) **Nimetus** **Jewelry, particularly pendant**

(55) **Reproduksioon**

DM/068400-01



(11) Rahvusvah reg nr	DM/068400	(51) Klass: 11-01
(21) Rahvusvah reg jrk	H200700002E	
(15) Registreeringu päev	08.12.2006	
(22) Esitamise päev	08.12.2006	
(28) Variantide arv	3	
(72) Autor	Arlette Elsa EMCH DUCOMMUN, Rue des Mornets 31, CH-2520 LA NEUVEVILLE, CH	
(73) Omanik	THE SWATCH GROUP MANAGEMENT SERVICES AG (THE SWATCH GROUP MANAGEMENT SERVICES SA), (THE SWATCH GROUP MANAGEMENT SERVICES LTD.), Seevorstadt 6, CH-2502 BIENNE, CH	

**WIPO Rahvusvah Tööstusdisainilahenduste
Bülletääni nr, kus registreering on avaldatud** 2006/12

(54) **Nimetus** **Jewelry, particularly necklaces**

(55) **Reproduksioon**

DM/068400-01



DM/068400-02



DM/068400-03



(11) Rahvusvah reg nr	DM/068403	(51) Klass: 10-02
(21) Rahvusvah reg jrk	H200700003	
(15) Registreeringu päev	29.11.2006	
(22) Esitamise päev	29.11.2006	
(28) Variantide arv	1	
(72) Autor	Andrea ARRIGONI, SWATCHLAB, Via Archimede 6, CH-20129 MILANO, CH	
(73) Omanik	SWATCH AG (SWATCH SA) (SWATCH LTD.), 94, Rue Jakob Stämpfli, CH-2502 BIENNE, CH	

**WIPO Rahvusvah Tööstusdisainilahenduste
Bülletääni nr, kus registreering on avaldatud** 2006/12

(54) **Nimetus** **Wristwatch**

(55) **Reproduksioon**

DM/068403-01



- (11) **Rahvusvah reg nr** DM/068429 (51) Klass: **11-01**
- (21) **Rahvusvah reg jrk** H200700005
- (15) **Registreeringu päev** 19.12.2006
- (22) **Esitamise päev** 19.12.2006
- (28) **Variantide arv** 1
- (72) **Autor** Arlette Elsa EMCH DUCOMMUN, rue des Mornets 31,
CH-2550 La Neuveville, CH
- (73) **Omanik** MONTRES BREGUET S.A., CH-1344 L'ABBAYE, CH
- WIPO Rahvusvah Tööstusdisainilahenduste**
Bülletääni nr, kus registreering on avaldatud 2006/12
- (54) **Nimetus** Jewelry, particularly brooch
- (55) **Reproduktsoon**

DM/068429-01



- (11) **Rahvusvah reg nr** DM/068429 (51) Klass: **11-01**
- (21) **Rahvusvah reg jrk** H200700005A
- (15) **Registreeringu päev** 19.12.2006
- (22) **Esitamise päev** 19.12.2006
- (28) **Variantide arv** 1
- (72) **Autor** Arlette Elsa EMCH DUCOMMUN, rue des Mornets 31,
CH-2550 La Neuveville, CH
- (73) **Omanik** MONTRES BREGUET S.A., CH-1344 L'ABBAYE, CH
- WIPO Rahvusvah Tööstusdisainilahenduste**
Bülletääni nr, kus registreering on avaldatud 2006/12

(54) **Nimetus** Jewelry, particularly necklace

(55) **Reproduksioon**

DM/068429-01

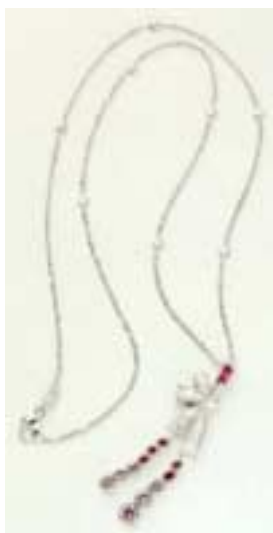

III. REGISTREERINGU KEHTIVUSE PIKENDAMINE

(11)	(18)				
00637	17.05.2012	00660	18.07.2012	00679	26.07.2012
00644	20.05.2012	00661	18.07.2012	00680	26.07.2012
00647	10.06.2012	00662	18.07.2012	00681	26.07.2012
00649	12.06.2012	00663	18.07.2012	00685	18.07.2012
00655	18.07.2012	00664	18.07.2012	00691	19.07.2012
00656	18.07.2012	00668	19.07.2012	00705	22.07.2012
00657	18.07.2012	00676	22.07.2012	00718	03.07.2012
00658	18.07.2012	00677	26.07.2012	00719	06.08.2012
00659	18.07.2012	00678	26.07.2012	00723	22.07.2012

IV. TÖÖSTUSDISAINILAHENDUSE ÜLEMINEK

Reg nr	Uue omaniku andmed	Registrikande jõustumise päev
00466	Kersti Harkmann, Ristiku 4, 50110 Tartu, EE	07.05.2007

VI. MUUD REGISTREERINGU ANDMETE MUUDATUSED

Reg nr	Muudetud andmed	Registrikande jõustumise päev
00644	AS A. Le Coq, Tähtvere 56/62, 50050 Tartu, EE	06.06.2007
00668	OÜ DISAINIABI, Ringi 44a-71, 74112 Maardu, EE	18.07.2007

XI. TÖÖSTUSDISAINILAHENDUSE KUSTUTAMINE REGISTRIST

"Tööstusdisaini kaitse seaduse" paragrahvi 77 lõike 1 alusel on registrist kustutatud järgmised tööstusdisainilahendused:

Reg nr	Kustutamise jõustumise päev
--------	-----------------------------

00595	02.11.2006
00596	16.11.2006
00597	04.12.2006
00600	06.12.2006
00602	28.11.2006
00606	09.11.2006
00610	11.12.2006
00613	24.12.2006
00618	21.12.2006
00642	11.12.2006

"Tööstusdisaini kaitse seaduse" paragrahvi 77 lõike 2 alusel on registrist kustutatud järgmised tööstusdisainilahendused:

Reg nr	Kustutamise jõustumise päev
--------	-----------------------------

01180	30.05.2007
-------	------------

XII. LOENDID**REGISTREERITUD TÖÖSTUSDISAINILAHENDUSTE SÜSTEMAATILINE LOEND**

Rahvusvahelise klassifikatsiooni klass ja alaklass(id)	Registreerimis-taotluse number	Registreeringu number
--	--------------------------------	-----------------------

02-02	D200700009	01321	09-01	D200600010	01319
06-06	D200700018	01322	09-03	D200700039	01329
06-06	D200700019	01323	11-02	D200700008	01320
08-10	D200700020	01324	14-03	D200700027	01326
09-01	D200500081	01312	19-06	D200700018	01322
09-01	D200500082	01313	19-06	D200700019	01323
09-01	D200500083	01314	20-03	D200700035	01328
09-01	D200500084	01315	21-01	D200700024	01325
09-01	D200500085	01316	23-03	D200700032	01327
09-01	D200500086	01317	99-00	D200500080	01311
09-01	D200500087	01318			

REGISTREERITUD TÖÖSTUSDISAINILAHENDUSTE REGISTREERIMISTAOTLUSTE NUMBRILINE LOEND

Registreerimis-taotluse number	Registreeringu number	Rahvusvahelise klassifikatsiooni klass(id) ja alaklass(id)
--------------------------------	-----------------------	--

D200500080	01311	99-00	D200700018	01322	06-06
D200500081	01312	09-01	D200700018	01322	19-06
D200500082	01313	09-01	D200700019	01323	06-06
D200500083	01314	09-01	D200700019	01323	19-06
D200500084	01315	09-01	D200700020	01324	08-10
D200500085	01316	09-01	D200700024	01325	21-01
D200500086	01317	09-01	D200700027	01326	14-03
D200500087	01318	09-01	D200700032	01327	23-03
D200600010	01319	09-01	D200700035	01328	20-03
D200700008	01320	11-02	D200700039	01329	09-03
D200700009	01321	02-02			

AVALDATUD RAHVUSVAHELISE REGISTREERINGU REGISTREERIMISE OTSUSE TEADETE NUMBRILINE LOEND

DM/067891	DM/068195	DM/068224	DM/068277	DM/068359	DM/068403
DM/067929	DM/068195	DM/068229	DM/068278	DM/068361	DM/068429
DM/068195	DM/068195	DM/068251	DM/068303	DM/068400	DM/068429
DM/068195	DM/068195	DM/068254	DM/068304	DM/068400	
DM/068195	DM/068196	DM/068255	DM/068317	DM/068400	
DM/068195	DM/068203	DM/068257	DM/068323	DM/068400	
DM/068195	DM/068209	DM/068258	DM/068341	DM/068400	
DM/068195	DM/068217	DM/068275	DM/068348	DM/068400	

XIII. TÖÖSTUSDISAINIALASED ÕIGUSAKTID JA MUU INFO**RIIKLIKUS PATENDIVOLNIKE REGISTRIS REGISTREERITUD PATENDIVOLNIKE NIMEKIRI**
(seisuga 19. detsember 2006)

Register on asutatud 1. septembril 2001. a Vabariigi Valitsuse 7. augusti 2001. a määrusega nr 271 "Riikliku patendivolinike registri asutamine ja registri pidamise põhimäärus" (RT I 2001, 70, 426) patendivoliniku seaduse § 21 alusel (RT I 2001, 27, 151).

TEGEVUSVALDKOND: KAUBAMÄRK, TÖÖSTUSDISAINILAHENDUS JA GEOGRAAFILINE TÄHIS

Arno ANIJALG	OÜ USTERVALL Kivi 21-6 51009 Tartu pk 21, 50002 Tartu telefon: 744 1980 telefaks: 744 1785 e-post: anijalg@ustervall.ee http://www.ustervall.ee võõrkeeled: saksa, vene	Juhan HÄMMALOV	OÜ Intels Riia 11-3 51010 Tartu telefon: 742 0401 telefaks: 742 0326 e-post: intelses@estpak.ee võõrkeeled: inglise, saksa, vene
Aivo ARULA	Patendibüroo Käosaar & Co OÜ Tähe 94 50107 Tartu telefon: 738 3051 telefaks: 738 3055 e-post: info@kaosaar.ee http://www.kaosaar.ee võõrkeeled: inglise, vene	Uno JÄÄGER	Inseneribüroo Uneko OÜ Rüütli 51a, 80010 Pärnu telefon: 447 1021 telefaks: 447 1001 GSM: 515 1844 e-post: uno@estpak.ee võõrkeeled: inglise, soome, vene
Martina BÖCKLER-LORVI	OÜ LASVET Suurtüki 4a, 10133 Tallinn pk 3136, 10505 Tallinn telefon: 640 6600 telefaks: 640 6604 e-post: lasvet@lasvet.ee http://www.lasvet.ee võõrkeeled: inglise, soome	Sirje KAHU	OÜ USTERVALL Kivi 21-6 51009 Tartu pk 21, 50002 Tartu telefon: 744 1980 telefaks: 744 1785 e-post: skahu@ustervall.ee http://www.ustervall.ee võõrkeeled: inglise, vene
Indrek EELMETS	OÜ LASVET Suurtüki 4a, 10133 Tallinn pk 3136, 10505 Tallinn telefon: 640 6600 telefaks: 640 6604 e-post: lasvet@lasvet.ee http://www.lasvet.ee võõrkeeled: inglise, vene, soome	Lembit KALEV	Patendibüroo ROOSILLA OÜ Järveotsa tee 39-61 13520 Tallinn telefon: 657 1722, 657 5381 telefaks: 657 5381 GSM: 511 9951 e-post: roosilla@roosilla.ee http://www.roosilla.ee võõrkeeled: inglise, vene
Alla HÄMMALOV	OÜ Intels Riia 11-3 51010 Tartu telefon: 742 0401 telefaks: 742 0326 e-post: intelses@estpak.ee võõrkeeled: inglise, poola, vene	Anneli KANG	OÜ Synest pk 977, 13402 Tallinn telefon: 660 9786 telefaks: 660 9787 e-post: anneli@synest.ee võõrkeeled: inglise, saksa, vene, prantsuse, soome, rootsi

- Urmast KAULER** **Patendibüroo TURVAJA OÜ**
Liivalaia 22
10118 Tallinn
telefon: 640 3109
telefaks: 640 3105
e-post: kauler@turvaja.ee
http://www.turvaja.ee
võõrkeeled: inglise, vene, soome
- Urmast KERNU** **AAA Patendibüroo OÜ**
Tartu mnt 16
10117 Tallinn
pk 3926, 10509 Tallinn
telefon: 660 5910, 660 5911
telefaks: 660 5912
e-post: aaa@aaa.ee
http://www.aaa.ee
võõrkeeled: inglise, saksa, soome, vene
- Ljubov KESSELMAN** **OÜ Kesna**
Tedre 77-52
10616 Tallinn
telefon: 660 8068
telefaks: 660 8069
e-post: kesna@kesna.ee
http://www.kesna.ee
võõrkeeled: inglise, vene
- Marina KESSELMAN** **OÜ Kesna**
Tedre 77-52
10616 Tallinn
telefon: 660 8068
telefaks: 660 8069
e-post: kesna@kesna.ee
http://www.kesna.ee
võõrkeeled: inglise, saksa, vene
- Heinu KOITEL** **Patendi- & Kaubamärgibüroo Koitel OÜ**
Tartu mnt 65
10115 Tallinn
pk 1759, 10902 Tallinn
telefon: 603 3260
telefaks: 603 3261
e-post: koitel@koitel.ee
http://www.koitel.ee
võõrkeeled: inglise, soome, vene
- Raivo KOITEL** **Patendi- & Kaubamärgibüroo Koitel OÜ**
Tartu mnt 65
10115 Tallinn
pk 1759, 10902 Tallinn
telefon: 603 3260
telefaks: 603 3261
e-post: koitel@koitel.ee
http://www.koitel.ee
võõrkeeled: inglise, soome, vene
- Mart Enn KOPPEL** **Patendibüroo Koppel OÜ**
Kajaka 4-10
11317 Tallinn
telefon: 677 4136
telefaks: 677 4138
e-post: info@koppelpb.com
http://www.koppelpb.com
võõrkeeled: inglise, vene, soome
- Heinrich KRUPP** **Patendibüroo TURVAJA OÜ**
Liivalaia 22
10118 Tallinn
telefon: 640 3109
telefaks: 640 3105
e-post: turvaja@turvaja.ee
http://www.turvaja.ee
võõrkeeled: saksa, vene
- Jüri KÄOSAAR** **Patendibüroo Käosaar & Co OÜ**
Tähe 94
50107 Tartu
telefon: 738 3051
telefaks: 738 3055
e-post: info@kaosaar.ee
http://www.kaosaar.ee
võõrkeeled: inglise, vene
- Kalev KÄOSAAR** **Patendibüroo Käosaar & Co OÜ**
Peterburi tee 46
11415 Tallinn
telefon: 637 9484
telefaks: 637 9485
e-post: kalev.kaosaar@kaosaar.ee
http://www.kaosaar.ee
võõrkeeled: inglise, vene
- Reet MAASIKAMÄE** **OÜ Kaitsepurus**
Mulla 4-3
10611 Tallinn
telefon: 673 9097, 633 2798
telefaks: 677 4844
e-post: purus@online.ee
purus@hot.ee
http://www.hot.ee/purus/
võõrkeeled: inglise, vene
- Raivo MATSOO** **RM Hirvela Patendibüroo OÜ**
Saku 15, 11314 Tallinn
telefon: 614 0816
telefaks: 614 0818
e-post: hirvela@hirvela.ee
võõrkeeled: inglise, vene

Elle MELLIK	AAA Patendibüroo OÜ Tartu mnt 16 10117 Tallinn pk 3926, 10509 Tallinn telefon: 660 5910, 660 5911 telefaks: 660 5912 e-post: aaa@aaa.ee http://www.aaa.ee võõrkeeled: inglise, vene	Jaak OSTRAT	OÜ LASVET Suurtüki 4a, 10133 Tallinn pk 3136, 10505 Tallinn telefon: 640 6600 telefaks: 640 6604 e-post: lasvet@lasvet.ee http://www.lasvet.ee võõrkeeled: inglise, saksa, soome, vene
Lembit MITT	AAA Patendibüroo OÜ Tartu mnt 16 10117 Tallinn pk 3926, 10509 Tallinn telefon: 660 5910, 660 5911 telefaks: 660 5912 e-post: aaa@aaa.ee http://www.aaa.ee võõrkeeled: inglise, vene	Villu PAVELTS	OÜ LASVET Suurtüki 4a, 10133 Tallinn pk 3136, 10505 Tallinn telefon: 640 6600 telefaks: 640 6604 e-post: lasvet@lasvet.ee http://www.lasvet.ee võõrkeeled: inglise, soome, vene
Ott MOORLAT	OÜ Moorlat & Ko Patendibüroo pk 723, 12902 Tallinn telefon: 655 0450, 654 2844 telefaks: 654 2844 e-post: ott.moorlat@moorlat.ee http://www.moorlat.ee võõrkeeled: inglise, vene	Toom PUNGAS	OÜ Synest pk 977, 13402 Tallinn telefon: 660 9786 telefaks: 660 9787 e-post: toom@synest.ee võõrkeeled: inglise, saksa, soome, vene
Anfia MORNA	Patendibüroo TURVAJA OÜ Liivalaia 22, 10118 Tallinn telefon: 640 3109 telefaks: 640 3105 e-post: morna@turvaja.ee http://www.turvaja.ee võõrkeeled: inglise, vene	Kaie PUUR	Patendibüroo Käosaar & Co OÜ Tähe 94 50107 Tartu telefon: 738 3051 telefaks: 738 3055 e-post: info@kaosaar.ee http://www.kaosaar.ee võõrkeeled: inglise, vene
Tõnu NELSAS	AAA Patendibüroo OÜ Tartu mnt 16 10117 Tallinn pk 3926, 10509 Tallinn telefon: 660 5910, 660 5911 telefaks: 660 5912 e-post: aaa@aaa.ee http://www.aaa.ee võõrkeeled: inglise, vene, soome	Riina PÄRN	OÜ Intels Riia 11-3 51010 Tartu telefon: 742 0401 telefaks: 742 0326 e-post: intelses@estpak.ee võõrkeeled: inglise, vene
Jüri OLT	Patendibüroo Käosaar & Co OÜ Tähe 94, 50107 Tartu telefon: 738 3051 telefaks: 738 3055 e-post: info@kaosaar.ee http://www.kaosaar.ee võõrkeeled: inglise, saksa, soome, vene	Tarmo ROSMAN	Rosman ja Partnerid OÜ pk 652, 12602 Tallinn telefon: 656 1450 telefaks: 656 1450 e-post: tarman@cc.ttu.ee võõrkeeled: saksa, inglise, ungari, vene
		Arvo SALUMÄE	OÜ Amende Patendibüroo Raua 65 10152 Tallinn telefon: 648 6125 telefaks: 641 0174 e-post: amende@hot.ee võõrkeeled: inglise, saksa, soome, vene

Almar SEHVER**AAA Patendibüroo OÜ**

Tartu mnt 16
10117 Tallinn
pk 3926, 10509 Tallinn
telefon: 660 5910, 660 5911
telefaks: 660 5912
e-post: aaa@aaa.ee
<http://www.aaa.ee>
võõrkeeled: inglise, vene

Olga TREUFELDT**Patendibüroo TURVAJA OÜ**

Liivalaia 22
10118 Tallinn
telefon: 640 3109
telefaks: 640 3105
e-post: olga@turvaja.ee
<http://www.turvaja.ee>
võõrkeeled: inglise, vene

Harald TEHVER**Patendibüroo TURVAJA OÜ**

Liivalaia 22
10118 Tallinn
telefon: 640 3109
telefaks: 640 3105
e-post: tehver@turvaja.ee
<http://www.turvaja.ee>
võõrkeeled: inglise, saksa, vene

Enn URGAS**Patendibüroo TURVAJA OÜ**

Liivalaia 22
10118 Tallinn
telefon: 640 3109
telefaks: 640 3105
e-post: urgas@turvaja.ee
<http://www.turvaja.ee>
võõrkeeled: inglise, vene

Mari TOOMSOO**Patendibüroo Käosaar & Co OÜ**

Peterburi tee 46, 11415 Tallinn
telefon: 637 9484
telefaks: 637 9485
e-post: mari.toomsoo@kaosaar.ee
<http://www.kaosaar.ee>
võõrkeeled: inglise, soome

Juta-Maris UUSTALU**OÜ Amende Patendibüroo**

Raua 65
10152 Tallinn
telefon: 648 6125
telefaks: 641 0174
e-post: amende@hot.ee
võõrkeeled: inglise, vene

**LIST OF PATENT ATTORNEYS, REGISTERED IN
THE ESTONIAN STATE REGISTER OF PATENT ATTORNEYS**
(by 19 December 2006)

Register is established on September 1st 2001

FIELD OF ACTIVITY: TRADEMARKS, INDUSTRIAL DESIGNS AND GEOGRAPHICAL INDICATIONS

Arno ANIJALG	USTERVALL Ltd. Kivi 21-6 51009 Tartu, Estonia P.O. Box 21 50002 Tartu, Estonia Phone: +372 744 1980 Fax: +372 744 1785 E-mail: anijalg@ustervall.ee Http://www.ustervall.ee German, Russian, Estonian	Juhan HÄMMALOV	Intels Ltd. Riia Str. 11-3 51010 Tartu, Estonia Phone: +372 742 0401 Fax: +372 742 0326 E-mail: intelses@estpak.ee English, German, Russian, Estonian
Aivo ARULA	Patent Agency Käosaar & Co Tähe Str. 94 50107 Tartu, Estonia Phone: +372 738 3051 Fax: +372 738 3055 E-mail: info@kaosaar.ee Http://www.kaosaar.ee English, Russian, Estonian	Uno JÄÄGER	Inseneribüroo Uneko Ltd. Rüütli 51a 80010 Pärnu, Estonia Phone: +372 447 1021 Fax: +372 447 1001 GSM: +372 515 1844 E-mail: uno@estpak.ee English, Finnish, Russian, Estonian
Martina BÖCKLER-LORVI	Lasvet Ltd. P.O. Box 3136 10505 Tallinn, Estonia Phone: +372 640 6600 Fax: +372 640 6604 E-mail: lasvet@lasvet.ee Http://www.lasvet.ee English, Finnish, Estonian	Sirje KAHU	USTERVALL Ltd. Kivi 21-6 51009 Tartu, Estonia P.O. Box 21 50002 Tartu, Estonia Phone: +372 744 1980 Fax: +372 744 1785 E-mail: skahu@ustervall.ee Http://www.ustervall.ee English, Russian, Estonian
Indrek EELMETS	Lasvet Ltd. P.O. Box 3136 10505 Tallinn, Estonia Phone: +372 640 6600 Fax: +372 640 6604 E-mail: lasvet@lasvet.ee Http://www.lasvet.ee English, Finnish, Russian, Estonian	Lembit KALEV	Patent Bureau ROOSILLA Ltd. Järveotsa Road 39-61 13520 Tallinn, Estonia Phone: +372 657 1722 +372 657 5381 Fax: +372 657 5381 GSM: +372 511 9951 E-mail: roosilla@roosilla.ee Http://www.roosilla.ee English, Russian, Estonian
Alla HÄMMALOV	Intels Ltd. Riia Str. 11-3 51010 Tartu, Estonia Phone: +372 742 0401 Fax: +372 742 0326 E-mail: intelses@estpak.ee English, Polish, Russian, Estonian	Anneli KANG	Synest Ltd. P.O. Box 977 13402 Tallinn, Estonia Phone: +372 660 9786 Fax: +372 660 9787 E-mail: anneli@synest.ee English, German, Russian, French, Finnish, Swedish, Estonian

Urmast KAULER	Patendibüroo TURVAJA OÜ Liivalaia 22 10118 Tallinn, Estonia Phone: +372 640 3109 Fax: +372 640 3105 E-mail: kauler@turvaja.ee Http://www.turvaja.ee English, Russian, Finnish, Estonian	Raivo KOITEL	Patent & Trademark Agency Koitel Tartu Road 65 10115 Tallinn, Estonia P.O. Box 1759 10902 Tallinn, Estonia Phone: +372 603 3260 Fax: +372 603 3261 E-mail: koitel@koitel.ee Http://www.koitel.ee English, Finnish, Russian, Estonian
Urmast KERNU	AAA Legal Services Tartu Road 16 10117 Tallinn, Estonia P.O. Box 3926 10509 Tallinn, Estonia Phone: +372 660 5910 +372 660 5911 Fax: +372 660 5912 E-mail: aaa@aaa.ee Http://www.aaa.ee English, German, Finnish, Russian, Estonian	Mart Enn KOPPEL	Patent Bureau Koppel Kajaka 4-10 11317 Tallinn, Estonia Phone: +372 677 4136 Fax: +372 677 4138 E-mail: info@koppelpb.com Http://www.koppelpb.com English, Russian, Finnish, Estonian
Marina KESSELMAN	Kesna Ltd. Tedre Str. 77-52 10616 Tallinn, Estonia Phone: +372 660 8068 Fax: +372 660 8069 E-mail: kesna@kesna.ee Http://www.kesna.ee English, German, Russian, Estonian	Heinrich KRUPP	Patendibüroo TURVAJA OÜ Liivalaia 22 10118 Tallinn, Estonia Phone: +372 640 3109 Fax: +372 640 3105 E-mail: turvaja@turvaja.ee Http://www.turvaja.ee German, Russian, Estonian
Ljubov KESSELMAN	Kesna Ltd. Tedre Str. 77-52 10616 Tallinn, Estonia Phone: +372 660 8068 Fax: +372 660 8069 E-mail: kesna@kesna.ee Http://www.kesna.ee English, Russian, Estonian	Jüri KÄOSAAR	Patent Agency Käosaar & Co Tähe Str. 94 50107 Tartu, Estonia Phone: +372 738 3051 Fax: +372 738 3055 E-mail: info@kaosaar.ee Http://www.kaosaar.ee English, Russian, Estonian
Heinu KOITEL	Patent & Trademark Agency Koitel Tartu Road 65 10115 Tallinn, Estonia P.O. Box 1759 10902 Tallinn, Estonia Phone: +372 603 3260 Fax: +372 603 3261 E-mail: koitel@koitel.ee Http://www.koitel.ee English, Finnish, Russian, Estonian	Kalev KÄOSAAR	Patent Agency Käosaar & Co Peterburi Road 46 11415 Tallinn, Estonia Phone: +372 637 9484 Fax: +372 637 9485 E-mail: kalev.kaosaar@kaosaar.ee Http://www.kaosaar.ee English, Russian, Estonian

- Reet MAASIKAMÄE** **Patent Bureau Kaitsepurus Ltd.**
Mulla Str. 4-3
10611 Tallinn, Estonia
Phone: +372 673 9097
+372 633 2798
Fax: +372 677 4844
E-mail: purus@online.ee
purus@hot.ee
Http://www.hot.ee/purus/
English, Russian, Estonian
- Raivo MATSOO** **RM Hirvela Patent Bureau Ltd**
Saku 15, 11314 Tallinn, Estonia
Phone: +372 614 0816
Fax: +372 614 0818
E-mail: hirvela@hirvela.ee
English, Russian, Estonian
- Elle MELLIK** **AAA Legal Services**
Tartu Road 16
10117 Tallinn, Estonia
P.O. Box 3926
10509 Tallinn, Estonia
Phone: +372 660 5910
+372 660 5911
Fax: +372 660 5912
E-mail: aaa@aaa.ee
Http://www.aaa.ee
English, Russian, Estonian
- Lembit MITT** **AAA Legal Services**
Tartu Road 16
10117 Tallinn, Estonia
P.O. Box 3926
10509 Tallinn, Estonia
Phone: +372 660 5910
+372 660 5911
Fax: +372 660 5912
E-mail: aaa@aaa.ee
Http://www.aaa.ee
English, Russian, Estonian
- Ott MOORLAT** **Moorlat & Co Ltd. Patent Bureau**
P.O. Box 723
12902 Tallinn, Estonia
Phone: +372 655 0450
+372 654 2844
Fax: +372 654 2844
E-mail: ott.moorlat@moorlat.ee
Http://www.moorlat.ee
English, Russian, Estonian
- Anfia MORNA**
- Tõnu NELSAS**
- Patendibüroo TURVAJA OÜ**
Liivalaia 22
10118 Tallinn, Estonia
Phone: +372 640 3109
Fax: +372 640 3105
E-mail: morna@turvaja.ee
Http://www.turvaja.ee
English, Russian, Estonian
- AAA Legal Services**
Tartu Road 16
10117 Tallinn, Estonia
P.O. Box 3926
10509 Tallinn, Estonia
Phone: +372 660 5910
+372 660 5911
Fax: +372 660 5912
E-mail: aaa@aaa.ee
Http://www.aaa.ee
English, Russian, Finnish, Estonian
- Jüri OLT**
- Patent Agency Käosaar & Co**
Tähe Str. 94
50107 Tartu, Estonia
Phone: +372 738 3051
Fax: +372 738 3055
E-mail: info@kaosaar.ee
Http://www.kaosaar.ee
English, German, Finnish, Russian, Estonian
- Jaak OSTRAT**
- Lasvet Ltd.**
P.O. Box 3136
10505 Tallinn, Estonia
Phone: +372 640 6600
Fax: +372 640 6604
E-mail: lasvet@lasvet.ee
Http://www.lasvet.ee
English, German, Finnish, Russian, Estonian
- Villu PAVELTS**
- Lasvet Ltd.**
P.O. Box 3136
10505 Tallinn, Estonia
Phone: +372 640 6600
Fax: +372 640 6604
E-mail: lasvet@lasvet.ee
Http://www.lasvet.ee
English, Finnish, Russian, Estonian
- Toom PUNGAS**
- Synest Ltd.**
P.O. Box 977
13402 Tallinn, Estonia
Phone: +372 660 9786
Fax: +372 660 9787
E-mail: toom@synest.ee
English, German, Finnish, Russian, Estonian

- Kaie PUUR** **Patent Agency Käosaar & Co**
Tähe Str. 94
50107 Tartu, Estonia
Phone: +372 738 3051
Fax: +372 738 3055
E-mail: info@kaosaar.ee
Http://www.kaosaar.ee
English, Russian, Estonian
- Harald TEHVER** **Patendibüroo TURVAJA OÜ**
Liivalaia 22
10118 Tallinn, Estonia
Phone: +372 640 3109
Fax: +372 640 3105
E-mail: tehver@turvaja.ee
Http://www.turvaja.ee
English, German, Russian,
Estonian
- Riina PÄRN** **Intels Ltd.**
Riia Str. 11-3
51010 Tartu, Estonia
Phone: +372 742 0401
Fax: +372 742 0326
E-mail: intelses@estpak.ee
English, Russian,
Estonian
- Mari TOOMSOO** **Patent Agency Käosaar & Co**
Peterburi Str. 46
11415 Tallinn, Estonia
Phone: +372 637 9484
Fax: +372 637 9485
E-mail: mari.toomsoo@kaosaar.ee
Http://www.kaosaar.ee
English, Finnish, Estonian
- Tarmo ROSMAN** **Rosman and Partners Ltd.**
P.O. Box 652
12602 Tallinn, Estonia
Phone: +372 656 1450
Fax: +372 656 1450
E-mail: tarman@cc.ttu.ee
German, English, Hungarian,
Russian, Estonian
- Olga TREUFELDT** **Patendibüroo TURVAJA OÜ**
Liivalaia 22
10118 Tallinn, Estonia
Phone: +372 640 3109
Fax: +372 640 3105
E-mail: olga@turvaja.ee
Http://www.turvaja.ee
English, Russian, Estonian
- Arvo SALUMÄE** **AMENDE Patent Agency Ltd.**
Raua 65, 10152 Tallinn, Estonia
Phone: +372 648 6125
Fax: +372 641 0174
E-mail: amende@hot.ee
English, German, Finnish,
Russian, Estonian
- Enn URGAS** **Patendibüroo TURVAJA OÜ**
Liivalaia 22
10118 Tallinn, Estonia
Phone: +372 640 3109
Fax: +372 640 3105
E-mail: urgas@turvaja.ee
Http://www.turvaja.ee
English, Russian, Estonian
- Almar SEHVER** **AAA Legal Services**
Tartu Road 16
10117 Tallinn, Estonia
P.O. Box 3926
10509 Tallinn, Estonia
Phone: +372 660 5910
+372 660 5911
Fax: +372 660 5912
E-mail: aaa@aaa.ee
Http://www.aaa.ee
English, Russian, Estonian
- Juta-Maris UUSTALU** **AMENDE Patent Agency Ltd.**
Raua 65, 10152 Tallinn, Estonia
Phone: +372 648 6125
Fax: +372 641 0174
E-mail: amende@hot.ee
English, Russian, Estonian