



ISSN 1406-376X

EESTI VABARIIK

T **EESTI**
TÖÖSTUSDISAINI-
LAHENDUSE LEHT



PATENDIAMETI AMETLIK VÄLJAANNE

3
2006
TALLINN



ISSN 1406-376X

EESTI VABARIIK

T **EESTI**
TÖÖSTUSDISAINI-
LAHENDUSE LEHT

**PATENDIAMETI
AMETLIK VÄLJAANNE**

IX aastakäik

**Käesolevas numbris
esitatud andmed
loetakse avaldatuks
15. augustil 2006. a.**

3
2006
AUGUST
TALLINN

Eesti Tööstusdisainilahenduse Lehte antakse välja tööstusdisaini kaitse seaduse (jõustunud 11.01.1998) alusel.
The Estonian Industrial Design Gazette is the official publication of the Estonian Patent Office.
Published under Industrial Design Protection Law of the Republic of Estonia (coming into force 11 January 1998).
Date of publication of the data presented in this issue - 15 August 2006.

Patendiameti
infoosakond
Toompuiestee 7
15041 Tallinn
Tel 627 7907
Faks 627 7943
E-post Info@epa.ee

The Information Department
of the Estonian Patent Office
Toompuiestee 7
15041 Tallinn, ESTONIA
Phone +372 627 7907
Fax +372 627 7943
E-mail Info@epa.ee

Levitaja

Eesti Patendiraamatukogu
Olevimägi 8/10
10123 Tallinn
Tel 641 1248
Faks 641 1018
E-post patent@patentlib.ee

Distributor

Estonian Patent Library
Olevimägi 8/10
10123 Tallinn, ESTONIA
Phone +372 641 1248
Fax +372 641 1018
E-mail patent@patentlib.ee

SISUKORD

Andmete identifitseerimise rahvusvahelised numberkoodid (INID-koodid)	4
Riikide, teiste ühenduste ja valitsustevaheliste organisatsioonide koodid	5
I. REGISTREERITUD TÖÖSTUSDISAINILAHENDUSED	6
II. RAHVUSVAHELISELT REGISTREERITUD TÖÖSTUSDISAINILAHENDUSED	19
III. REGISTREERINGU KEHTIVUSE PIKENDAMINE	56
IV. TÖÖSTUSDISAINILAHENDUSE ÜLEMINEK	-
V. REGISTREERINGU JAGAMINE	-
VI. MUUD REGISTREERINGU ANDMETE MUUDATUSED	-
VII. REGISTREERINGU ANDMETE PARANDUSED	-
VIII. TÖÖSTUSDISAINILAHENDUSE LITSENTSIDE REGISTREERIMINE	-
IX. TÖÖSTUSDISAINILAHENDUSE PANTIDE REGISTREERIMINE	-
X. TUNNISTUSE DUPLIKAADI VÄLJAANDMINE	-
XI. TÖÖSTUSDISAINILAHENDUSE KUSTUTAMINE REGISTRIST	56
XII. LOENDID	57
Registreeritud tööstusdisainilahenduste süstemaatiline loend	57
Registreeritud tööstusdisainilahenduste registreerimistaotluste numbriline loend	57
Avaldatud rahvusvahelise registreeringu registreerimise otsuse teadete numbriline loend	57
XIII. TÖÖSTUSDISAINIALASED ÕIGUSAKTID JA MUU INFO	58
Riiklikus patendivolinike registris registreeritud patendivolinike nimekiri	58

CONTENTS

Internationally Agreed Numbers for the Identification of Data (INID Codes)	4
List of Codes of States, Other Entities and Intergovernmental Organizations	5
I. REGISTERED INDUSTRIAL DESIGNS	6
II. INTERNATIONALLY REGISTERED INDUSTRIAL DESIGNS	19
III. EXTENSION OF THE REGISTRATION	56
IV. TRANSFER OF INDUSTRIAL DESIGN	-
V. DIVISION OF THE REGISTRATION.	-
VI. OTHER AMENDMENTS TO REGISTRATION DATA	-
VII. CORRECTIONS TO REGISTRATION DATA	-
VIII. REGISTERING OF LICENSES OF INDUSTRIAL DESIGN	-
IX. REGISTERING OF PLEDGES OF INDUSTRIAL DESIGN	-
X. ISSUE OF A COPY OF THE INDUSTRIAL DESIGN CERTIFICATE	-
XI. DELETION OF INDUSTRIAL DESIGN FROM THE REGISTER	56
XII. LISTS	57
Systematic List of Registered Industrial Designs	57
Numerical List of Registration Applications of Registered Industrial Designs	57
Numerical List of Published Notices of Decisions on Registration of the International Registration	57
XIII. LEGAL ACTS AND INFORMATION CONCERNING INDUSTRIAL DESIGNS	58
List of Patent Attorneys, Registered in the Estonian State Register of Patent Attorneys	62

**ANDMETE IDENTIFITSEERIMISE
RAHVUSVAHELISED NUMBERKOODID
(INID-KOODID)
WIPO Standard ST. 80**

**INTERNATIONALLY AGREED NUMBERS FOR
THE IDENTIFICATION OF DATA
(INID CODES)
WIPO Standard ST. 80**

(11) Registreeringu number	(11) Number of the Registration
(15) Registreerimise kuupäev	(15) Date of the Registration
(18) Registreeringu kehtivuse lõppemise kuupäev	(18) Expected expiration date of the registration
(21) Registreerimistaotluse number	(21) Application Number
(22) Registreerimistaotluse esitamise kuupäev	(22) Application Filing Date
(24) Registreeringu kehtivuse alguse kuupäev	(24) Date from which the Industrial Design right has effected
(28) Variantide arv	(28) Number of Industrial Designs included in the application
(30) Prioriteet	(30) Priority
(51) Rahvusvahelise klassifikatsiooni klassi ja alaklassi number	(51) International Classification for Industrial Designs (class and subclass of the Locarno Classification)
(54) Tööstusdisainilahenduse nimetus	(54) Title of the Industrial Design
(55) Tööstusdisainilahenduse reproduktsioon	(55) Reproduction of the Industrial Design
(72) Tööstusdisainilahenduse autor(id)	(72) Author(s) of Industrial Design
(73) Tööstusdisainilahenduse omanik(ud)	(73) Proprietor(s) of Industrial Design
(74) Patendivolinik või ühine esindaja	(74) Patent Attorney or Common Representative

**RIIKIDE, TEISTE ÜHENDUSTE JA VALITSUSTEVAAHELISTE
ORGANISATSIOONIDE KOODID**

AD	Andorra	DO	Dominikaani	IT	Itaalia	PT	Portugal
AE	Araabia		Vabariik	JM	Jamaica	PW	Belau
	Ühendemiraadid	DZ	Alžeeria	JO	Jordania	PY	Paraguay
AF	Afganistan	EA	Euraasia	JP	Jaapan	QA	Katar
AG	Antigua ja Barbuda		Patendiorganisat-	KE	Kenya	RO	Rumeenia
AI	Anguilla		sioon (EAPO)	KG	Kõrgõzstan	RU	Venemaa
AL	Albaania	EC	Ecuador	KH	Kambodža	RW	Rwanda
AM	Armeenia	EE	Eesti	KI	Kiribati	SA	Saudi Araabia
AN	Hollandi Antillid	EG	Egiptus	KM	Komoorid	SB	Salomoni Saared
AO	Angola	EH	Lääne-Sahara	KN	Saint Kitts ja Nevis	SC	Seišellid
AP	Aafrika Regionaalne	EM	Siseturu	KP	Põhja-Korea	SD	Sudaan
	Tööstusomandi Orga-		Ühtlustamise	KR	Lõuna-Korea	SE	Rootsi
	nisatsioon (ARIPO)		Amet (kaubamärgid	KW	Kuveit	SG	Singapur
AR	Argentina		ja tööstusdisaini-	KY	Kaimanisaared	SH	Saint Helena
AS	Ameerika Samoa		lahendused)(OHIM)	KZ	Kasahstan	SI	Sloveenia
AT	Austria	EP	Euroopa	LA	Laos	SK	Slovakkia
AU	Austraalia		Patendiamet (EPO)	LB	Liibanon	SL	Sierra Leone
AW	Aruba	ER	Eritrea	LC	Saint Lucia	SM	San Marino
AZ	Aserbaidžaan	ES	Hispaania	LI	Liechtenstein	SN	Senegal
BA	Bosnia ja	ET	Etiopia	LK	Sri Lanka	SO	Somaalia
	Hertsegoviina	FI	Soome	LR	Libeeria	SR	Suriname
BB	Barbados	FJ	Fidži	LS	Lesotho	ST	São Tomé ja Príncipe
BD	Bangladesh	FK	Falklandi (Malviini)	LT	Leedu	SV	El Salvador
BE	Belgia		saared	LU	Luksemburg	SY	Süüria
BF	Burkina Faso	FM	Mikroneesia	LV	Läti	SZ	Svaasimaa
BG	Bulgaaria	FO	Fääri saared	LY	Liibüa	TC	Turks ja Caicos
BH	Bahrein	FR	Prantsusmaa	MA	Maroko	TD	Tšaad
BI	Burundi	GA	Gabon	MC	Monaco	TG	Togo
BJ	Benin	GB	Ühendkuningriik	MD	Moldova	TH	Tai
BM	Bermuda		(Suurbritannia)	MG	Madagaskar	TJ	Tadžikistan
BN	Brunei	GC	Pärsia Lahe	MH	Marshalli Saared	TM	Türkmenistan
BO	Boliivia		Koostöönõukogu	MK	Makedoonia	TN	Tuneesia
BR	Brasiilia	GD	Grenada	ML	Mali	TO	Tonga
BS	Bahama	GE	Gruusia	MM	Myanmar (Birma)	TL	Ida-Timor
BT	Bhutan	GH	Ghana	MN	Mongoolia	TR	Türgi
BV	Bouvet' saar	GI	Gibraltar	MO	Macao	TT	Trinidad ja Tobago
BW	Botswana	GL	Gröönimaa	MP	Põhja-Mariaanid	TV	Tuvalu
BX	Beneluxi	GM	Gambia	MR	Mauritaania	TW	Taiwan (Hiina provints)
	Kaubamärgiamet	GN	Guinea	MS	Montserrat	TZ	Tansaania
	(BBM) ja Beneluxi	GQ	Ekvatoriaal-Guinea	MT	Malta	UA	Ukraina
	Tööstusdisainilahen-	GR	Kreeka	MU	Mauritius	UG	Uganda
	duste Amet (BBDM)	GS	Lõuna-Georgia ja	MV	Maldiivid	US	Ameerika
BY	Valgevene		Lõuna-Sandwichi	MW	Malawi		Ühendriigid
BZ	Belize		saared	MX	Mehhiko	UY	Uruguay
CA	Kanada	GT	Guatemala	MY	Malaisia	UZ	Usbekistan
CF	Kesk-Aafrika	GW	Guinea-Bissau	MZ	Mosambiik	VA	Vatikan (Püha Tool)
	Vabariik	GY	Guyana	NA	Namiibia	VC	Saint Vincent ja
CG	Kongo	HK	Hongkong	NE	Niger		Grenadiinid
CH	Šveits	HN	Honduras	NG	Nigeeria	VE	Venezuela
CI	Côte d'Ivoire	HR	Horvaatia	NI	Nicaragua	VG	Neitsisaared
CK	Cooki saared	HT	Haiti	NL	Holland	VN	Vietnam
CL	Tšiili	HU	Ungari	NO	Norra	VU	Vanuatu
CM	Kamerun	IB	Ülemaailmse	NP	Nepal	WO	Ülemaailmne
CN	Hiina		Intellektuaalomandi	NR	Nauru		Intellektuaalomandi
CO	Kolumbia		Organisatsiooni	NZ	Uus-Meremaa		Organisatsioon
CR	Costa Rica		(WIPO) Rahvus-	OA	Aafrika Intellektuaal-		(WIPO) (Rahvus-
CS	Serbia ja Montenegro		vaheline Büroo		omandi Organisat-		vaheline Büroo)
CU	Kuuba	ID	Indoneesia		sioon (OAPI)	WS	Samoa
CV	Cabo Verde	IE	Iiri	OM	Omaan	YE	Jeemen
CY	Küpros	IL	Iisrael	PA	Panama	ZA	Lõuna-Aafrika Vabariik
CZ	Tšehhi	IM	Man'i saar	PE	Peruu	ZM	Sambia
DE	Saksamaa	IN	India	PG	Paapua Uus-Guinea	ZR	Zaire
DJ	Djibouti	IQ	Iraak	PH	Filipiinid	ZW	Zimbabwe
DK	Taani	IR	Iraan	PK	Pakistan		
DM	Dominica	IS	Island	PL	Poola		

I. REGISTREERITUD TÖÖSTUSDISAINILAHENDUSED

Avaldatakse "Tööstusdisaini kaitse seaduse" § 55¹ lõike 7 alusel.

Patendiamet ei ole kontrollinud tööstusdisainilahenduse uudsust ja eristatavust tulenevalt "Tööstusdisaini kaitse seaduse" § 31 lõike 2 punktist 1.

- (11) **Registreeringu number** **01164**
- (21) **Taotluse number** D200500079
- (15) **Registreerimise päev** 15.08.2006
- (22) **Esitamise päev** 09.12.2005
- (24) **Registreeringu kehtivuse alguse päev** 09.12.2005
- (18) **Registreeringu kehtivuse lõppemise päev** 09.12.2010
- (28) **Variantide arv** 1
- (30) **Prioriteediandmed** 29/231,712, 09.06.2005, US
- (72) **Autor** Justin Lyles, 12278 Scripps Summit Drive, San Diego, CA 92131, US
- (73) **Omanik** Nokia Corporation, Keilalahdentie 4, FIN-02150 Espoo, FI
- (74) **Patendivolinik või ühine esindaja** Kalev Käosaar

(51) Klass: 14-03

(54) **Nimetus** **Käsitelefon**(55) **Reproduktsoon**

01164-01

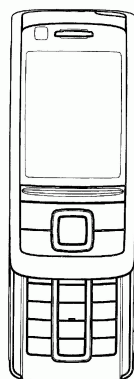
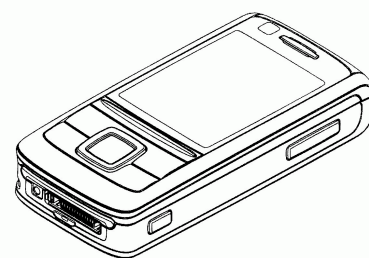
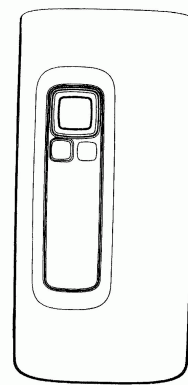
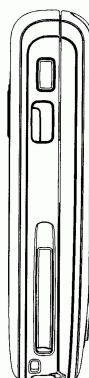
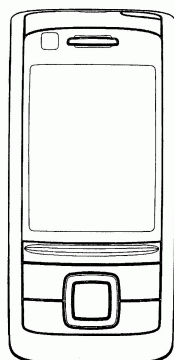
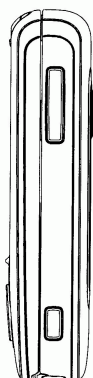
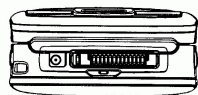

(11) Registreeringu number	01165
(21) Taotluse number	D200600002
(15) Registreerimise päev	15.08.2006
(22) Esitamise päev	11.01.2006
(24) Registreeringu kehtivuse alguse päev	11.01.2006
(18) Registreeringu kehtivuse lõppemise päev	11.01.2011
(28) Variantide arv	3
(72) Autor	Sander Saar, Saare 16, 12011 Tallinn, EE
(73) Omanik	Sander Saar, Saare 16, 12011 Tallinn, EE

(51) Klass: **03-01**(54) Nimetus **Rahakott**

(55) Reproduksioon

01165-01

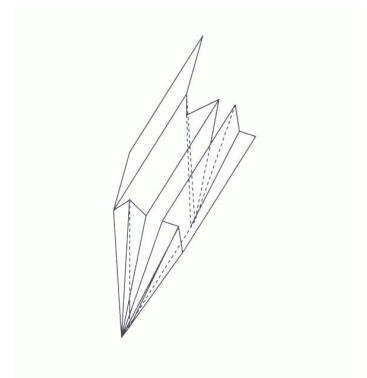
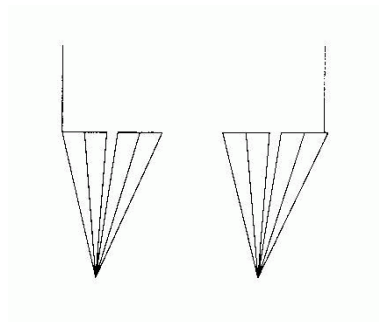
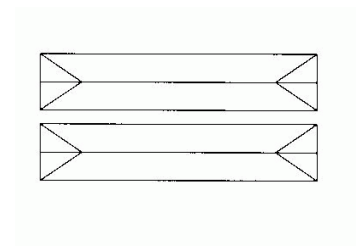
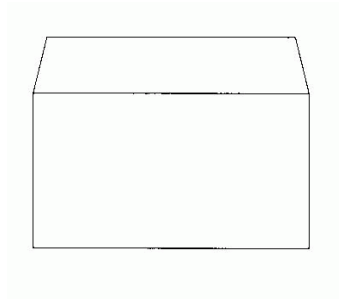
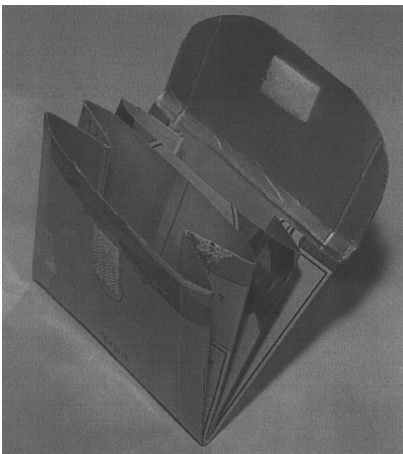

01165-02

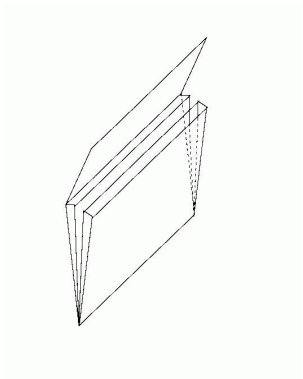
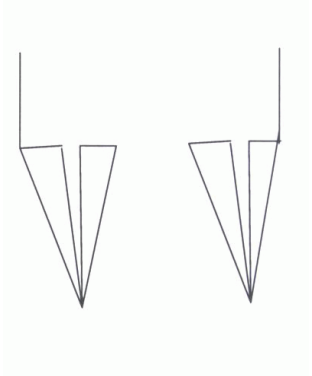
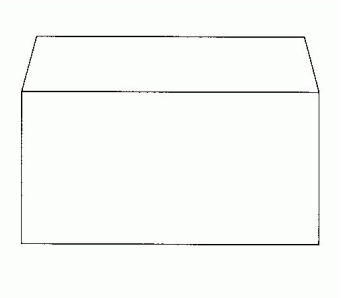
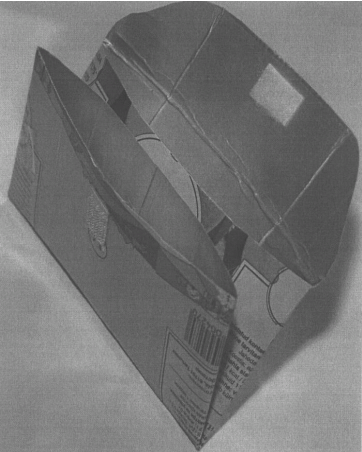

01165-03

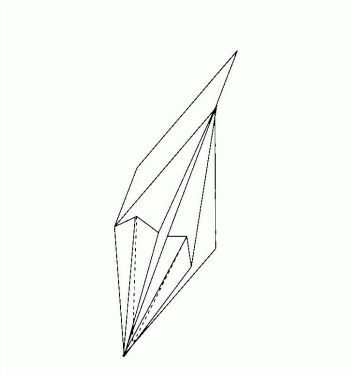
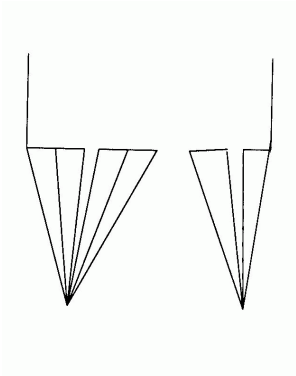
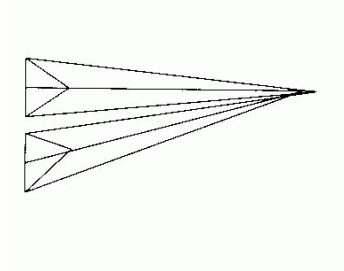
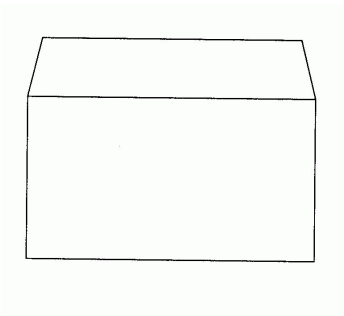
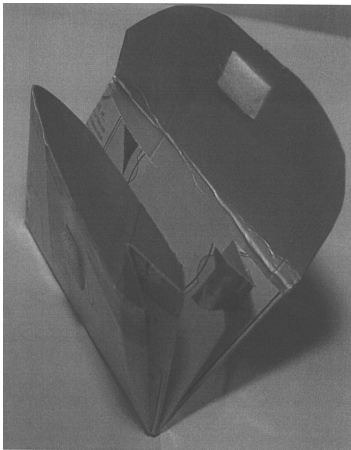

(11) Registreeringu number	01166	(51) Klass: 14-03
(21) Taotluse number	D200600016	
(15) Registreerimise päev	15.08.2006	
(22) Esitamise päev	22.03.2006	
(24) Registreeringu kehtivuse alguse päev	22.03.2006	
(18) Registreeringu kehtivuse lõppemise päev	22.03.2011	
(28) Variantide arv	1	
(30) Prioriteediandmed	M20050152, 03.10.2005, FI	
(72) Autor	Veikko Rihu, Puolalanpuisto 3A 5, 20100 Turku, FI Valtteri Eroma, Ramsaynranta 1 A 13, 00330 Helsinki, FI	
(73) Omanik	Nokia Corporation, Keilalahdentie 4, FIN-02150 Espoo, FI	
(74) Patendivolinik või ühine esindaja	Kaie Puur	

(54) Nimetus **Käsitelefon**

(55) Reproduktsoon

01166-01

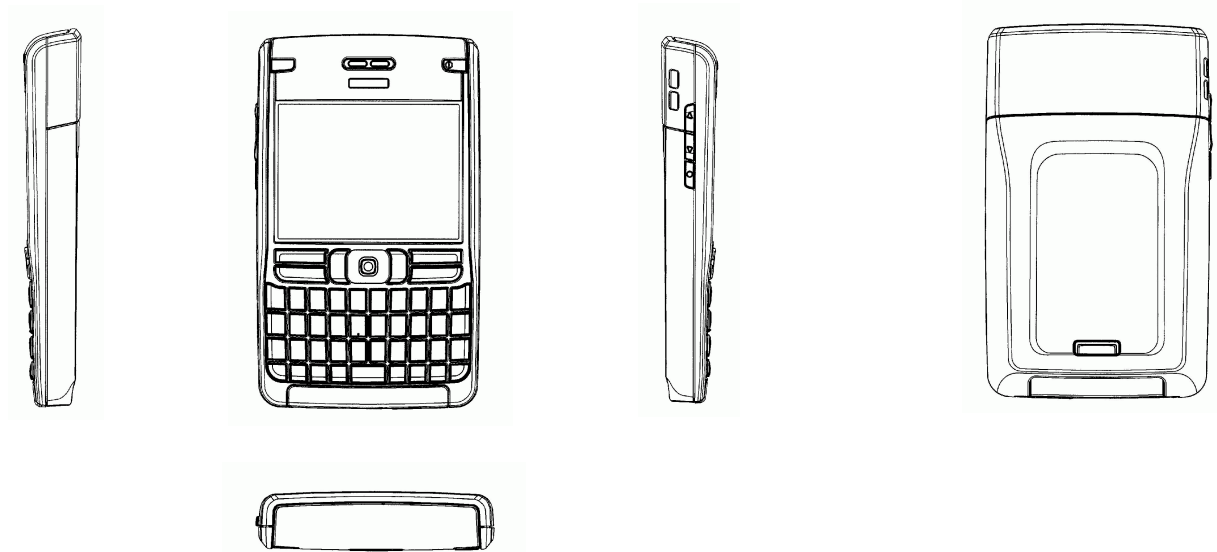

- (11) **Registreeringu number** **01167**
- (21) **Taotluse number** D200600017
- (15) **Registreerimise päev** 15.08.2006
- (22) **Esitamise päev** 24.03.2006
- (24) **Registreeringu kehtivuse alguse päev** 24.03.2006
- (18) **Registreeringu kehtivuse lõppemise päev** 24.03.2011
- (28) **Variantide arv** 1
- (30) **Prioriteediandmed** M200500169, 28.10.2005, FI
- (72) **Autor** Jean-Marc Hering, Honkatie 4 B, 24160 Salo, FI
Anthony Dalby, 30, Chandos Avenue, Ealing, London W5 4ER, GB
- (73) **Omanik** Nokia Corporation, Keilalahdentie 4, FIN-02150 Espoo, FI
- (74) **Patendivolinik või ühine esindaja** Kalev Käosaar

(51) Klass: 14-03

(54) **Nimetus** **Käsitelefon**(55) **Reproduktsoon**

01167-01

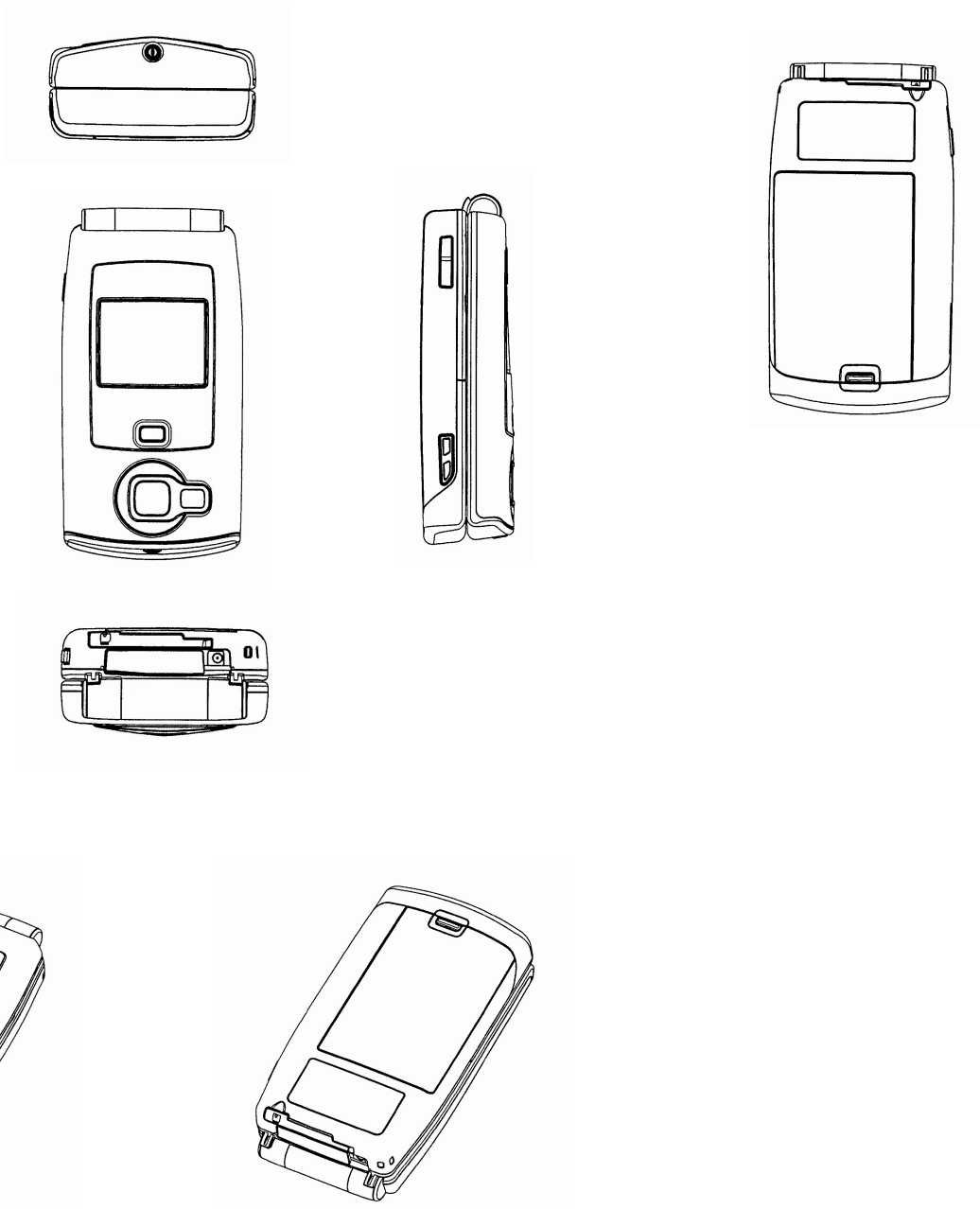

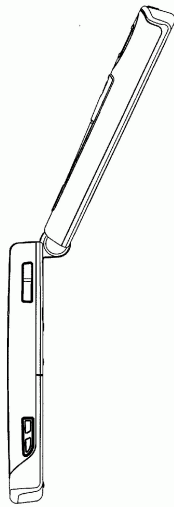
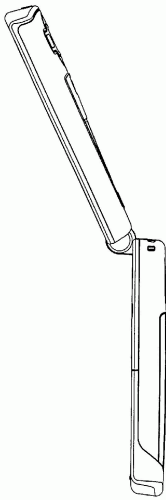
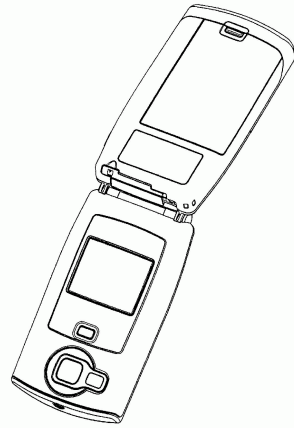
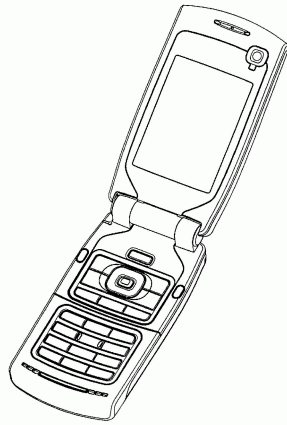
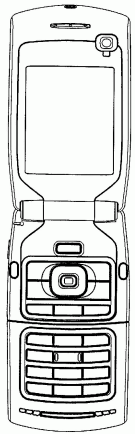

- (11) **Registreeringu number** **01168** (51) Klass: **14-03**
- (21) **Taotluse number** D200600018
- (15) **Registreerimise päev** 15.08.2006
- (22) **Esitamise päev** 24.03.2006
- (24) **Registreeringu kehtivuse alguse päev** 24.03.2006
- (18) **Registreeringu kehtivuse lõppemise päev** 24.03.2011
- (28) **Variantide arv** 1
- (30) **Prioriteediandmed** M20050168, 28.10.2005, FI
- (72) **Autor** Ingve Holmung, 68 Ormonde Court, Upper Richmond Road, London SW 15 6TP, GB
Anthony Dalby, 30, Chandos Avenue, Ealing, London W5 4ER, GB
- (73) **Omanik** Nokia Corporation, Keilalahdentie 4, FIN-02150 Espoo, FI
- (74) **Patendivolinik või ühine esindaja** Kalev Käosaar

(54) **Nimetus** **Käsitelefon**

(55) **Reproduktsoon**

01168-01

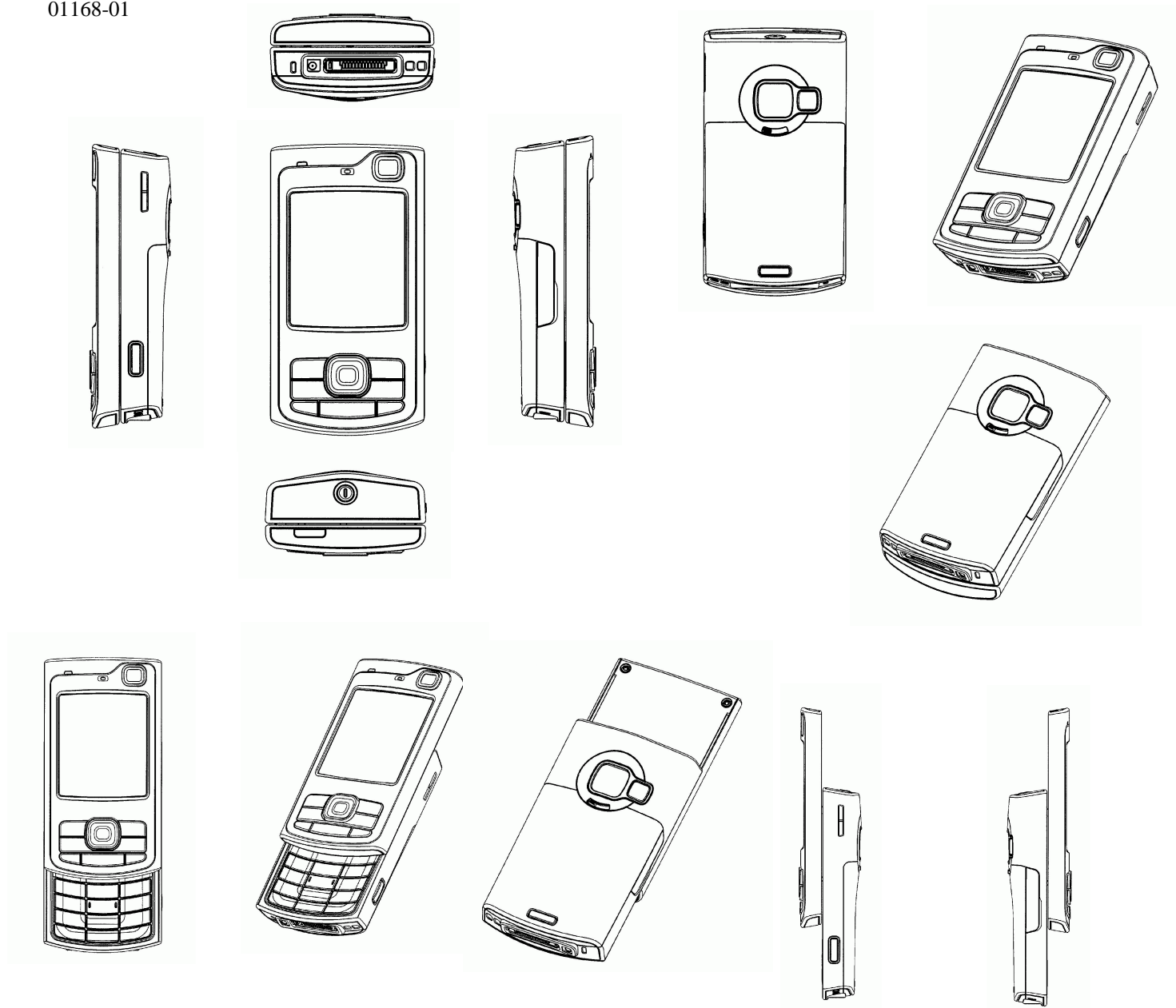

(11) Registreeringu number	01169	(51) Klass: 07-06
(21) Taotluse number	D200600023	
(15) Registreerimise päev	15.08.2006	
(22) Esitamise päev	12.04.2006	
(24) Registreeringu kehtivuse alguse päev	12.04.2006	
(18) Registreeringu kehtivuse lõppemise päev	12.04.2011	
(28) Variantide arv	2	
(72) Autor	Janek Luik, Valga 2A, Tõrva, 68606 Valga maakond, EE Peeter Kuuseste, Harju tee 15, Aruküla, Raasiku vald, 75201 Harju maakond, EE	
(73) Omanik	Janek Luik, Valga 2A, Tõrva, 68606 Valga maakond, EE Peeter Kuuseste, Harju tee 15, Aruküla, Raasiku vald, 75201 Harju maakond, EE	
(74) Patendivolinik või ühine esindaja	Lembit Mitt	

(54) **Nimetus** **Pudelihoidel**

(55) **Reproduktsoon**

01169-01

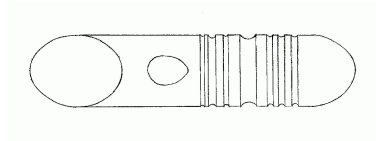
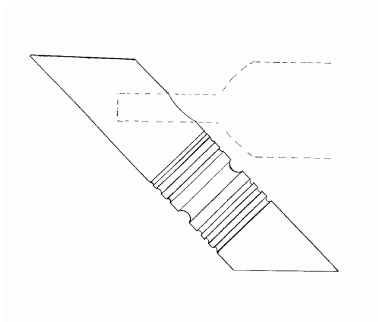

01169-02

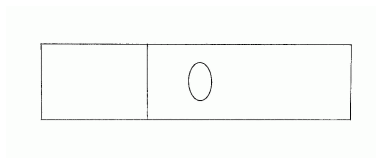
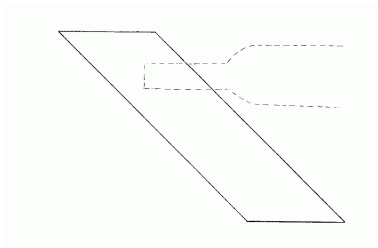

- (11) **Registreeringu number** **01170** (51) Klass: **14-03**
- (21) **Taotluse number** D200600026
- (15) **Registreerimise päev** 15.08.2006
- (22) **Esitamise päev** 28.04.2006
- (24) **Registreeringu kehtivuse alguse päev** 28.04.2006
- (18) **Registreeringu kehtivuse lõppemise päev** 28.04.2011
- (28) **Variantide arv** 1
- (30) **Prioriteediandmed** M20050170, 31.10.2005, FI
- (72) **Autor** Simon Bradford, 17 York road, Teddigton, Middlesex TW11 8SL, GB
Axel Meyer, Rannikkolaivurintie 23 C, 00850 Helsinki, FI
Sami Viitasaari, Valtarintie 2 as. 1, 91100 Ii, FI
- (73) **Omanik** Nokia Corporation, Keilalahdentie 4, FIN-02150 Espoo, FI
- (74) **Patendivolinik või ühine esindaja** Kaie Puur

(54) **Nimetus** **Käsitelefon**

(55) **Reproduktsoon**

01170-01

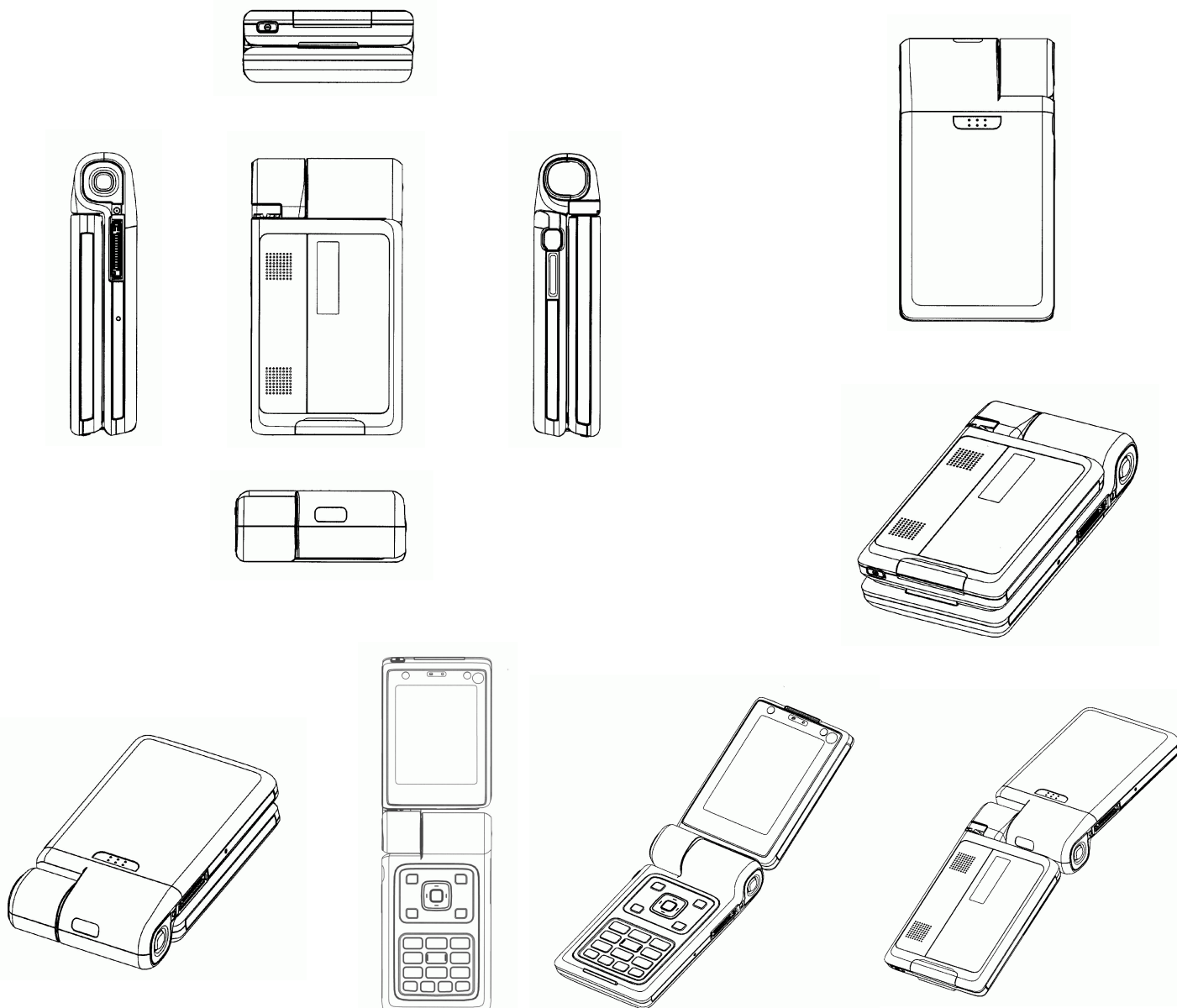

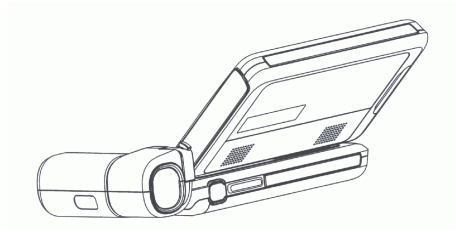
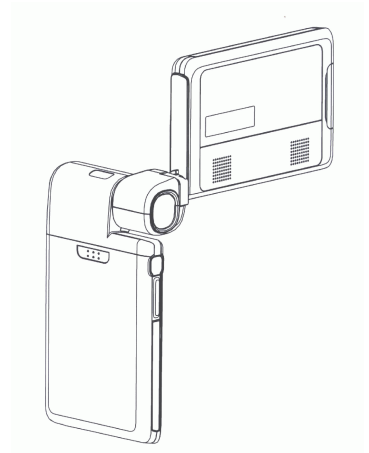
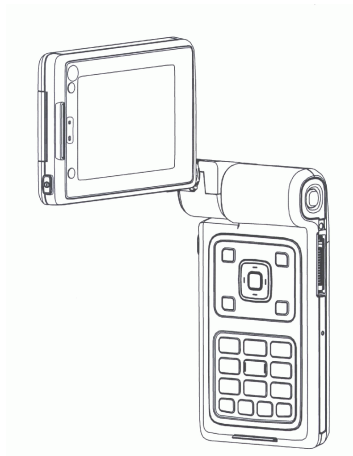

- (11) **Registreeringu number** **01171** (51) Klass: **10-04, 10-05, 10-06, 12-07, 14-03**
- (21) **Taotluse number** D200600029
- (15) **Registreerimise päev** 15.08.2006
- (22) **Esitamise päev** 10.05.2006
- (24) **Registreeringu kehtivuse alguse päev** 10.05.2006
- (18) **Registreeringu kehtivuse lõppemise päev** 10.05.2011
- (28) **Variantide arv** 1
- (72) **Autor** Leino Vint, Kadaka tee 113 A, 12915 Tallinn, EE
- (73) **Omanik** AS Laser Diagnostic Instruments, Kadaka tee 113 a, 12915 Tallinn, EE
- (74) **Patendivolinik või ühine esindaja** Ott Moorlat

(54) **Nimetus** **Kompaktne individuaalne lidarsüsteem**

(55) **Reproduktsoon**

01171-01

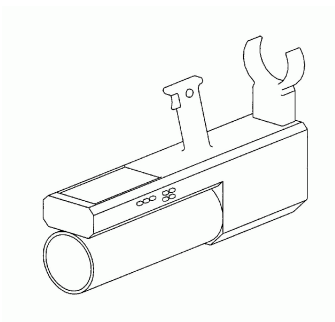
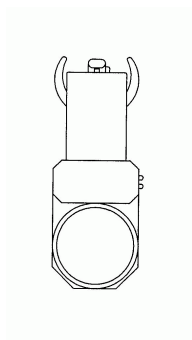
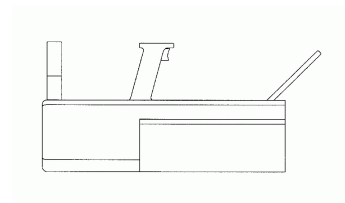
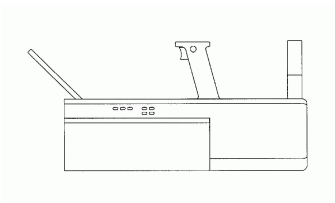
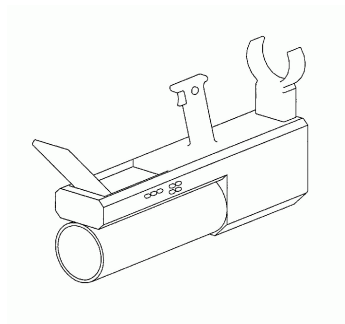

(11) Registreeringu number	01172
(21) Taotluse number	D200600030
(15) Registreerimise päev	15.08.2006
(22) Esitamise päev	11.05.2006
(24) Registreeringu kehtivuse alguse päev	11.05.2006
(18) Registreeringu kehtivuse lõppemise päev	11.05.2011
(28) Variantide arv	3
(72) Autor	Janno Roos, Niine 11, 10414 Tallinn, EE Andres Labi, Niine 11, 10414 Tallinn, EE
(73) Omanik	Ruumilabor OÜ, Niine 11, 10414 Tallinn, EE
(74) Patendivolinik või ühine esindaja	Ott Moorlat

(51) Klass: **06-11, 06-12**(54) Nimetus **Vaip**

(55) Reproduktsoon

01172-01

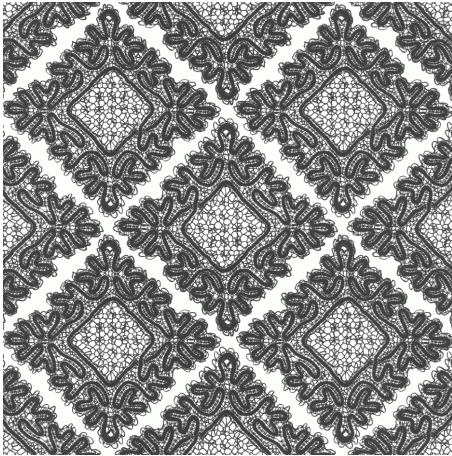

01172-02

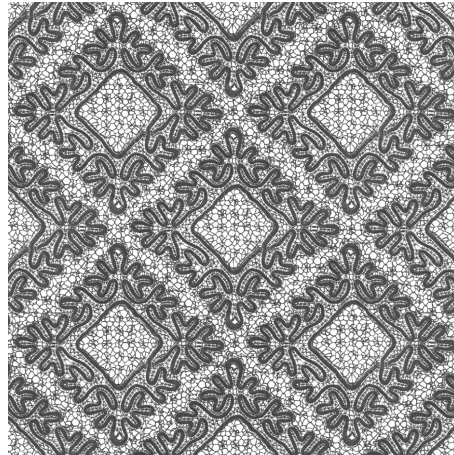

01172-03

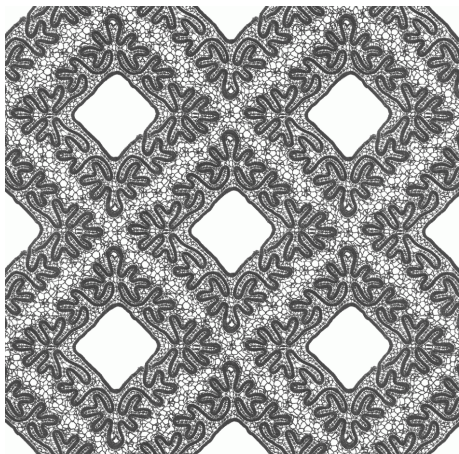

II. RAHVUSVAHELISELT REGISTREERITUD TÖÖSTUSDISAINILAHENDUSED

Avaldatakse "Tööstusdisaini kaitse seaduse" § 87⁴ lõike37 alusel.

(11) Rahvusvah reg nr	DM/066322	(51) Klass: 21-02
(21) Rahvusvah reg jrk	H200600001	
(15) Registreeringu päev	28.01.2005	
(22) Esitamise päev	28.01.2005	
(28) Variantide arv	1	
(72) Autor	<i>Autori andmeid ei avalikustata</i>	
(73) Omanik	Urs Giger, 3, Tugginerweg, CH-4503 Solothurn, CH Sonja Giger, 3, Tugginerweg, CH-4503 Solothurn, CH Adrian Giger, Erlenweg 19, CH-4514 Lommiswil, CH Thomas Giger, Bellacherstr. 5, CH-4513 Langendorf, CH Martin Giger, Ob. Steingrubenstr. 2, CH-4500 Solothurn, CH	

**WIPO Rahvusvah Tööstusdisainilahenduste
Bülletääni nr, kus registreering on avaldatud** 2005/12

(54) **Nimetus** **Physical exerciser**

(55) **Reproduktsoon**

DM/066322-01

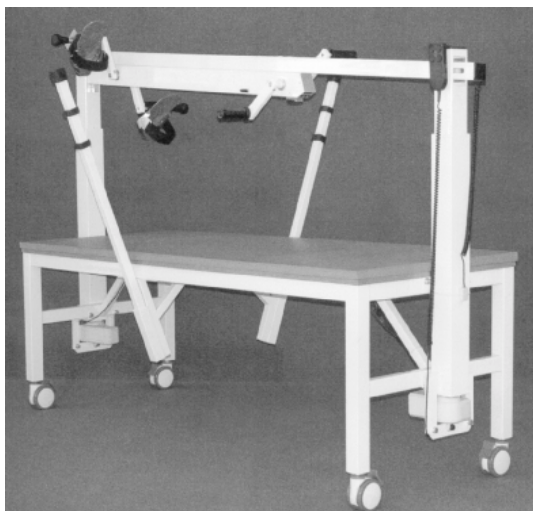

(11) Rahvusvah reg nr	DM/066339	(51) Klass: 21-02
(21) Rahvusvah reg jrk	H200600002	
(15) Registreeringu päev	13.01.2005	
(22) Esitamise päev	13.01.2005	
(28) Variantide arv	1	
(72) Autor	<i>Autori andmeid ei avalikustata</i>	
(73) Omanik	Urs Giger, 3, Tugginerweg, CH-4503 Solothurn, CH Sonja Giger, 3, Tugginerweg, CH-4503 Solothurn, CH Adrian Giger, Erlenweg 19, CH-4514 Lommiswil, CH Thomas Giger, Bellacherstr. 5, CH-4513 Langendorf, CH Martin Giger, Ob. Steingrubenstr. 2, CH-4500 Solothurn, CH	

**WIPO Rahvusvah Tööstusdisainilahenduste
Bülletääni nr, kus registreering on avaldatud** 2005/12

(54) **Nimetus** **Physical exerciser**

(55) **Reproduksioon**

DM/066339-01

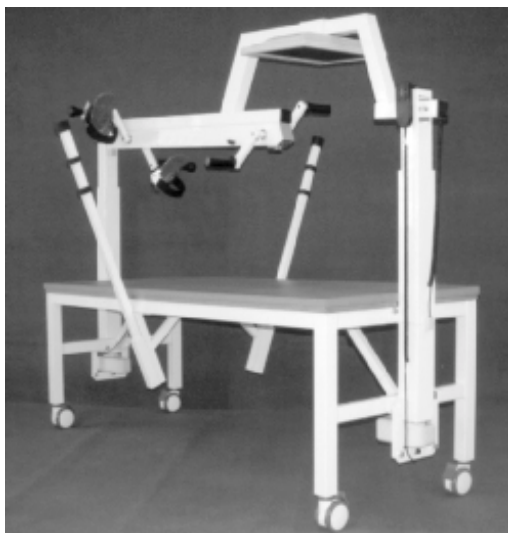

(11) **Rahvusvah reg nr**

DM/066432

(51) Klass: **10-02**

(21) **Rahvusvah reg jrk**

H200500137

(15) **Registreeringu päev**

17.03.2005

(22) **Esitamise päev**

17.03.2005

(28) **Variantide arv**

1

(72) **Autor**

Autori andmeid ei avalikustata

(73) **Omanik**

MAISON ELOGA HORLOGERIE ET BIJOUTERIE SÀRL,
Rue du Grenier 18, CH-2302 La Chaux-de-Fonds, CH

**WIPO Rahvusvah Tööstusdisainilahenduste
Bülletääni nr, kus registreering on avaldatud**

2005/08

(54) **Nimetus**

Wristwatch

(55) **Reproduksioon**

DM/066432-01



(11) Rahvusvah reg nr	DM/066450	(51) Klass: 08-07
(21) Rahvusvah reg jrk	H200500120	
(15) Registreeringu päev	31.08.2004	
(22) Esitamise päev	31.08.2004	
(28) Variantide arv	1	
(72) Autor	Marianna N. Berg, c/o ARIS International SA, 2 Kolinplatz, CH-6300 Zug, CH	
(73) Omanik	ARIS INTERNATIONAL SA, 2 Kolinplatz, CH-6300 Zug, CH	
WIPO Rahvusvah Tööstusdisainilahenduste Bülletääni nr, kus registreering on avaldatud	2005/07	

(54) **Nimetus** **Curved lock for luxury goods such as cases, boxes, holders for leather goods, watches and jewellery**

(55) **Reproduksioon**

DM/066450-01

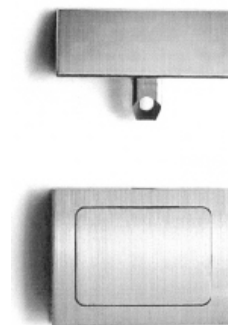
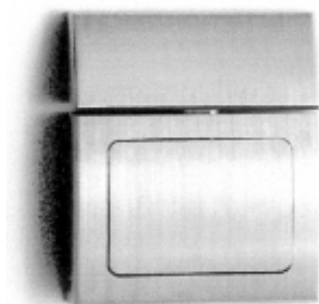

(11) Rahvusvah reg nr	DM/066528	(51) Klass: 10-02
(21) Rahvusvah reg jrk	H200500138	
(15) Registreeringu päev	03.03.2005	
(22) Esitamise päev	03.03.2005	
(28) Variantide arv	1	
(72) Autor	<i>Autori andmeid ei avalikustata</i>	
(73) Omanik	BÉDAT & CO SA, 45, rue Agasse, CH-1211 Genève 17, CH	
WIPO Rahvusvah Tööstusdisainilahenduste		
Bülletääni nr, kus registreering on avaldatud	2005/08	

(54) **Nimetus** **Wristwatch**

(55) **Reproduktsoon**

DM/066528-01



(11) Rahvusvah reg nr	DM/066668	(51) Klass: 10-07
(21) Rahvusvah reg jrk	H200500142	
(15) Registreeringu päev	12.04.2005	
(22) Esitamise päev	12.04.2005	
(28) Variantide arv	1	
(72) Autor	Patrick Joseph Lassigne, 23, chemin des Villarets, 2036 Cormondrèche, CH	
(73) Omanik	PATRICK JOSEPH LASSIGNE, 23, chemin des Villarets, CH-2036 Cormondrèche, CH	
WIPO Rahvusvah Tööstusdisainilahenduste Bülletääni nr, kus registreering on avaldatud	2005/09	

(54) **Nimetus** **Watch case with strap**

(55) **Reproduktsoon**

DM/066668-01



(11) **Rahvusvah reg nr**

DM/066673

(51) Klass: **09-03**

(21) **Rahvusvah reg jrk**

H200500160

(15) **Registreeringu päev**

10.06.2005

(22) **Esitamise päev**

10.06.2005

(28) **Variantide arv**

2

(72) **Autor**

Roger Nuetzi, Vordere Gasse 68, CH-4628 Wolfwil, CH

(73) **Omanik**

RENTSCH A.G., Industriestrasse 6W, CH-4613 Rickenbach, CH

WIPO Rahvusvah Tööstusdisainilahenduste

Bülletääni nr, kus registreering on avaldatud 2005/11

(54) **Nimetus**

Cigarette packs

(55) **Reproduktsoon**

DM/066673-01

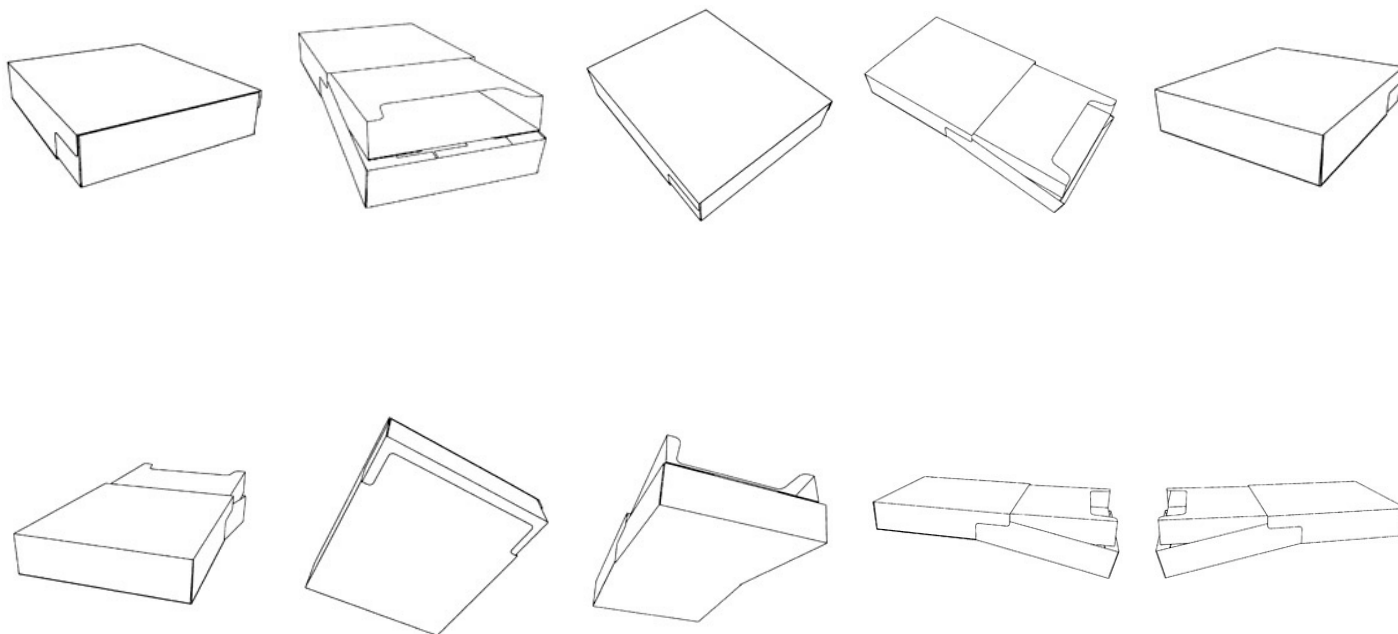

DM/066673-02

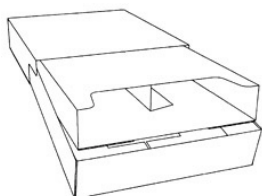

(11) Rahvusvah reg nr	DM/066678	(51) Klass: 10-07
(21) Rahvusvah reg jrk	H200500152	
(15) Registreeringu päev	02.05.2005	
(22) Esitamise päev	02.05.2005	
(28) Variantide arv	1	
(72) Autor	CÉSAR JEAN-MAIRET, Chemin du Petray 11, CH-1222 Vézenaz, CH MONTERRAT MARGALEF, Chemin du Petray 11, CH-12222 Vézenaz, CH	
(73) Omanik	CÉSAR JEAN-MAIRET, Chemin du Petray 11, CH-1222 Vézenaz, CH	
WIPO Rahvusvah Tööstusdisainilahenduste		
Bülletääni nr, kus registreering on avaldatud	2005/10	

(54) **Nimetus** **Watch case**

(55) **Reproduksioon**

DM/066678-01

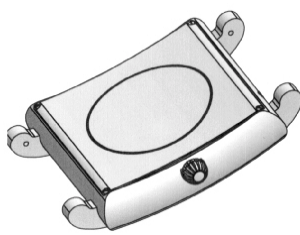
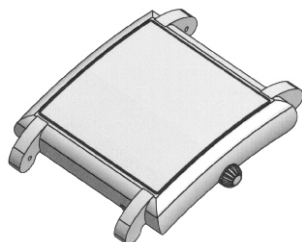
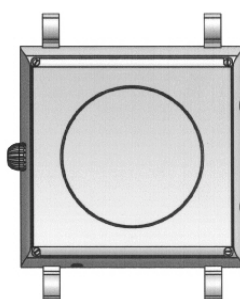
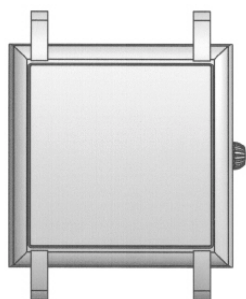

(11) Rahvusvah reg nr	DM/066724	(51) Klass: 10-02
(21) Rahvusvah reg jrk	H200500161	
(15) Registreeringu päev	03.06.2005	
(22) Esitamise päev	03.06.2005	
(28) Variantide arv	1	
(30) Prioriteediandmed	131425, 18.02.2005, CH	
(72) Autor	Daniel RIEDO, chemin Armand-Dufaux 70A, 1245 Collonge-Bellerive/Suisse, CH	
(73) Omanik	MONTRES TUDOR SA, 3, rue Francois-Dussaud, CH-1211 Genève, CH	
WIPO Rahvusvah Tööstusdisainilahenduste Bülletääni nr, kus registreering on avaldatud	2005/11	

(54) **Nimetus** **Watch bezel**

(55) **Reproduksioon**

DM/066724-01

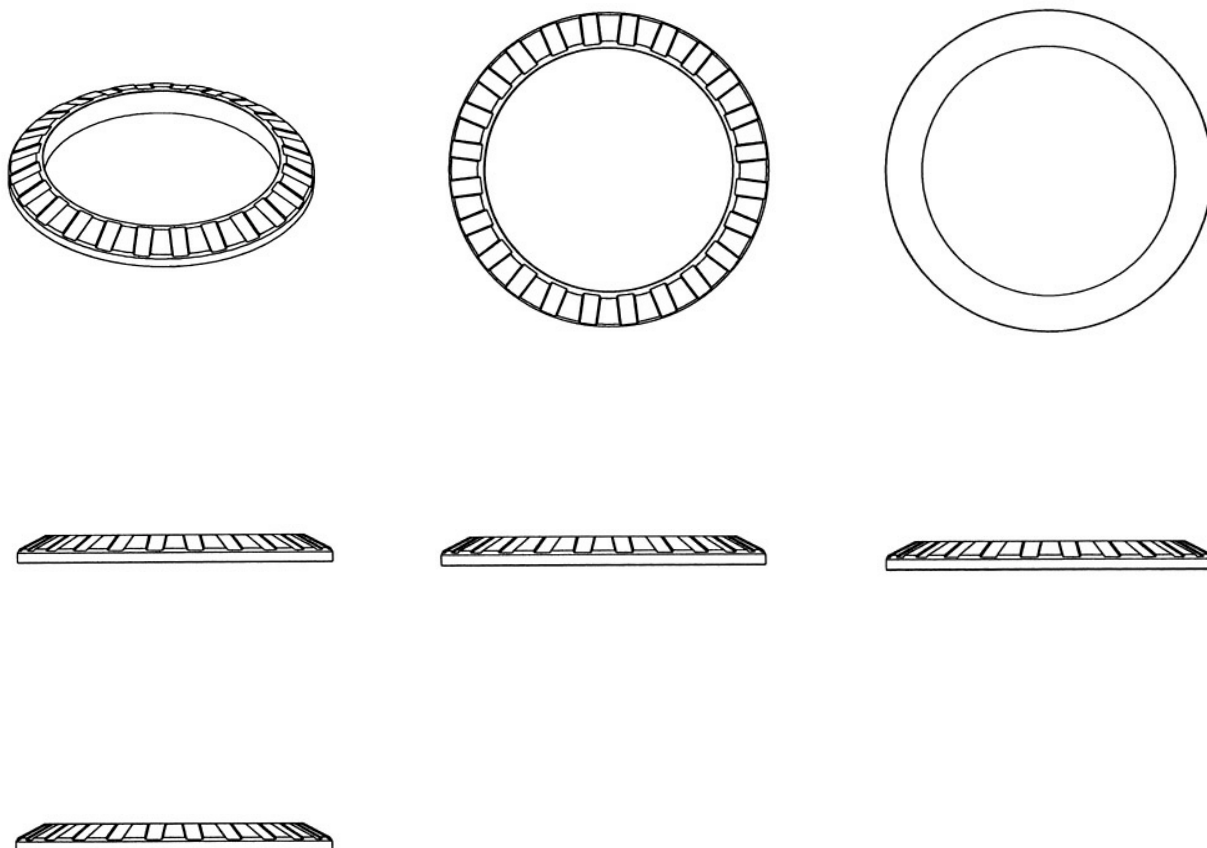

(11) Rahvusvah reg nr	DM/066728	(51) Klass: 10-02
(21) Rahvusvah reg jrk	H200500107	
(15) Registreeringu päev	06.06.2005	
(22) Esitamise päev	06.06.2005	
(28) Variantide arv	1	
(72) Autor	Léonie COCQUIO, DUPONT DESIGN SA, Rte des Jeunes 33, CH-1227 CAROUGE, CH	
(73) Omanik	SWATCH AG (SWATCH SA) (SWATCH LTD.), 94, Rue Jakob Stämpfli, CH-2502 BIENNE, CH	
WIPO Rahvusvah Tööstusdisainilahenduste Bülletääni nr, kus registreering on avaldatud	2005/06	

(54) **Nimetus** **Wristwatch**

(55) **Reproduksioon**

DM/066728-01



(11) Rahvusvah reg nr	DM/066729	(51) Klass: 10-02
(21) Rahvusvah reg jrk	H200500108	
(15) Registreeringu päev	06.06.2005	
(22) Esitamise päev	06.06.2005	
(28) Variantide arv	1	
(72) Autor	Alessandra FORNARI, SWATCHLAB, Via Archimede 6, IT-20129 MILANO, IT	
(73) Omanik	SWATCH AG (SWATCH SA) (SWATCH LTD.), 94, Rue Jakob Stämpfli, CH-2502 BIENNE, CH	
WIPO Rahvusvah Tööstusdisainilahenduste Bülletääni nr, kus registreering on avaldatud	2005/06	

(54) **Nimetus** **Wristwatch**

(55) **Reproduksioon**

DM/066729-01



(11) Rahvusvah reg nr	DM/066732	(51) Klass: 10-07
(21) Rahvusvah reg jrk	H200500111	
(15) Registreeringu päev	06.06.2005	
(22) Esitamise päev	06.06.2005	
(28) Variantide arv	1	
(72) Autor	Fabrice DUPONT, DUPONT DESIGN SA, Rte des Jeunes 33, CH-1227 CAROUGE, CH	
(73) Omanik	SWATCH AG (SWATCH SA) (SWATCH LTD.), 94, Rue Jakob Stämpfli, CH-2502 BIENNE, CH	
WIPO Rahvusvah Tööstusdisainilahenduste Bülletääni nr, kus registreering on avaldatud	2005/06	

(54) **Nimetus** **Watch band**

(55) **Reproduktsoon**

DM/066732-01



(11) Rahvusvah reg nr	DM/066760	(51) Klass: 25-01
(21) Rahvusvah reg jrk	H200500121	
(15) Registreeringu päev	25.02.2005	
(22) Esitamise päev	25.02.2005	
(28) Variantide arv	1	
(72) Autor	Usul Ibrahim, Gentseweg 37, B-9120 Beveren-Waas, BE	
(73) Omanik	USUL IBRAHIM, Gentseweg 37, B-9120 Beveren-Waas, BE	
WIPO Rahvusvah Tööstusdisainilahenduste Bülletääni nr, kus registreering on avaldatud	2005/07	

(54) **Nimetus** **Modular brick**

(55) **Reproduktsoon**

DM/066760-01

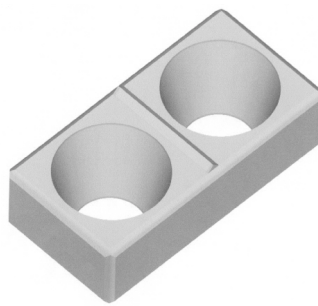
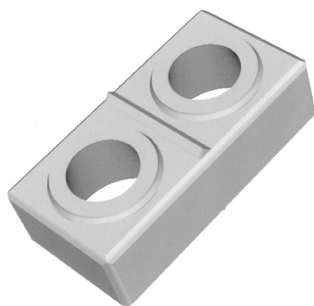

(11) Rahvusvah reg nr	DM/066822	(51) Klass: 28-03
(21) Rahvusvah reg jrk	H200500139	
(15) Registreeringu päev	22.03.2005	
(22) Esitamise päev	22.03.2005	
(28) Variantide arv	3	
(72) Autor	Nicole SGOBERO, CH-2924 Montignez, CH	
(73) Omanik	SWITTOOLS SA, Rue Théodore Dumont 1b, CH-2924 Montignez, CH	
WIPO Rahvusvah Tööstusdisainilahenduste Bülletääni nr, kus registreering on avaldatud	2005/08	

(54) **Nimetus** **1.-3. Hair-removing tweezers**

(55) **Reproduktsoon**

DM/066822-01

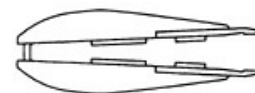
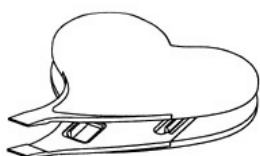

DM/066822-02



DM/066822-03



(11) **Rahvusvah reg nr****DM/066824**(51) Klass: **10-02**(21) **Rahvusvah reg jrk**

H200500162

(15) **Registreeringu päev**

20.06.2005

(22) **Esitamise päev**

20.06.2005

(28) **Variantide arv**

1

(72) **Autor***Autori andmeid ei avalikustata*(73) **Omanik**MAISON ELOGA HORLOGERIE ET BIJOUTERIE SÀRL,
Rue du Grenier 18, CH-2302 La Chaux-de-Fonds, CH**WIPO Rahvusvah Tööstusdisainilahenduste
Bülletääni nr, kus registreering on avaldatud**

2005/11

(54) **Nimetus****Wristwatch**(55) **Reproduktsoon**

DM/066824-01



(11) Rahvusvah reg nr	DM/066844	(51) Klass: 09-07
(21) Rahvusvah reg jrk	H200500164	
(15) Registreeringu päev	20.06.2005	
(22) Esitamise päev	20.06.2005	
(28) Variantide arv	9	
(72) Autor	<i>Autori andmeid ei avalikustata</i>	
(73) Omanik	SIGG SWITZERLAND AG, Walzmühlestrasse 62, CH-8501 Frauenfeld, CH	
WIPO Rahvusvah Tööstusdisainilahenduste Bületääni nr, kus registreering on avaldatud	2005/11	

(54) **Nimetus** **Closure caps for drinking bottles**

(55) **Reproduktsoon**

DM/066844-01



DM/066844-02



DM/066844-03



DM/066844-04

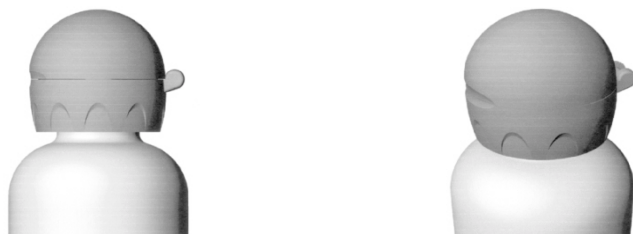

DM/066844-05



DM/066844-06



DM/066844-07



DM/066844-08



DM/066844-09



(11) Rahvusvah reg nr	DM/067072	(51) Klass: 10-02
(21) Rahvusvah reg jrk	H200500153	
(15) Registreeringu päev	14.10.2005	
(22) Esitamise päev	14.10.2005	
(28) Variantide arv	1	
(72) Autor	Ciara Baudet, DUPONT DESIGN SA, Route des Jeunes 33, CH-1227 CAROUGE, CH	
(73) Omanik	SWATCH AG (SWATCH SA) (SWATCH LTD.), 94, Rue Jakob Stämpfli, CH-2502 BIENNE, CH	
WIPO Rahvusvah Tööstusdisainilahenduste Bülletääni nr, kus registreering on avaldatud	2005/10	

(54) **Nimetus** **Wristwatch**

(55) **Reproduksioon**

DM/067072-01



(11) Rahvusvah reg nr	DM/067073	(51) Klass: 10-02
(21) Rahvusvah reg jrk	H200500154	
(15) Registreeringu päev	14.10.2005	
(22) Esitamise päev	14.10.2005	
(28) Variantide arv	1	
(72) Autor	Fabrizio CUPPINI, SWATCHLAB, Via Archimede 6, I-20129 MILANO, IT	
(73) Omanik	SWATCH AG (SWATCH SA) (SWATCH LTD.), 94, Rue Jakob Stämpfli, CH-2502 BIENNE, CH	
WIPO Rahvusvah Tööstusdisainilahenduste Bülletääni nr, kus registreering on avaldatud	2005/10	

(54) **Nimetus** **Wristwatch**

(55) **Reproduksioon**

DM/067073-01



(11) Rahvusvah reg nr	DM/067074	(51) Klass: 10-02
(21) Rahvusvah reg jrk	H200500155	
(15) Registreeringu päev	14.10.2005	
(22) Esitamise päev	14.10.2005	
(28) Variantide arv	1	
(72) Autor	Alfredo BELLAVEGLIA, Swatch SA, 94 rue Jakob Stämpfli, CH-2502 Bienne, CH	
(73) Omanik	SWATCH AG (SWATCH SA) (SWATCH LTD.), 94, Rue Jakob Stämpfli, CH-2502 BIENNE, CH	
WIPO Rahvusvah Tööstusdisainilahenduste Bülletääni nr, kus registreering on avaldatud	2005/10	

(54) **Nimetus** **Wristwatch**

(55) **Reproduksioon**

DM/067074-01



(11) Rahvusvah reg nr	DM/067088	(51) Klass: 10-02
(21) Rahvusvah reg jrk	H200500156	
(15) Registreeringu päev	05.10.2005	
(22) Esitamise päev	05.10.2005	
(28) Variantide arv	1	
(72) Autor	Stephan Messmer, MESSMER & SEILER GMBH, Industrial Design, Barföusserplatz 20, CH-4051 Basel, CH Alexander Seiler, MESSMER & SEILER GMBH, Industrial Design, Barföusserplatz 20, CH-4051 Basel, CH RADO UHREN AG (RADO WATCH CO. LTD.) (MONTRES RADO SA), Bielstrasse 45, CH-2543 Lengnau, CH	
(73) Omanik		
WIPO Rahvusvah Tööstusdisainilahenduste Bülletääni nr, kus registreering on avaldatud	2005/10	

(54) **Nimetus** **Wristwatch**

(55) **Reproduktsoon**

DM/067088-01



(11) Rahvusvah reg nr	DM/067117	(51) Klass: 10-02
(21) Rahvusvah reg jrk	H200500157	
(15) Registreeringu päev	13.10.2005	
(22) Esitamise päev	13.10.2005	
(28) Variantide arv	1	
(72) Autor	Léonie COCQUIO, DUPONT DESIGN SA, Route des Jeunes 33, CH-1227 CAROUGE, CH	
(73) Omanik	SWATCH AG (SWATCH SA) (SWATCH LTD.), 94, Rue Jakob Stämpfli, CH-2502 BIENNE, CH	

**WIPO Rahvusvah Tööstusdisainilahenduste
Bülletääni nr, kus registreering on avaldatud** 2005/10

(54) **Nimetus** **Watch**

(55) **Reproduktsoon**

DM/067117-01

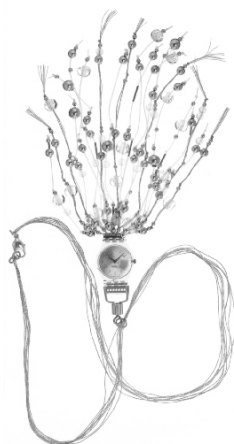

(11) Rahvusvah reg nr	DM/067118	(51) Klass: 10-02
(21) Rahvusvah reg jrk	H200500158	
(15) Registreeringu päev	13.10.2005	
(22) Esitamise päev	13.10.2005	
(28) Variantide arv	1	
(72) Autor	Léonie COCQUIO, DUPONT DESIGN SA, Route des Jeunes 33, CH-1227 CAROUGE, CH	
(73) Omanik	SWATCH AG (SWATCH SA) (SWATCH LTD.), 94, Rue Jakob Stämpfli, CH-2502 BIENNE, CH	
WIPO Rahvusvah Tööstusdisainilahenduste Bülletääni nr, kus registreering on avaldatud	2005/10	

(54) **Nimetus** **Wristwatch**

(55) **Reproduksioon**

DM/067118-01



(11) Rahvusvah reg nr	DM/067119	(51) Klass: 10-02
(21) Rahvusvah reg jrk	H200500159	
(15) Registreeringu päev	13.10.2005	
(22) Esitamise päev	13.10.2005	
(28) Variantide arv	1	
(72) Autor	Malcolm DRAGOTTA, SWATCHLAB, Via Archimede 6, IT-20129 Milano, IT	
(73) Omanik	SWATCH AG (SWATCH SA) (SWATCH LTD.), 94, Rue Jakob Stämpfli, CH-2502 BIENNE, CH	
WIPO Rahvusvah Tööstusdisainilahenduste Bülletääni nr, kus registreering on avaldatud	2005/10	

(54) **Nimetus** **Wristwatch**

(55) **Reproduksioon**

DM/067119-01



(11) Rahvusvah reg nr	DM/067232	(51) Klass: 10-02
(21) Rahvusvah reg jrk	H200600003	
(15) Registreeringu päev	06.12.2005	
(22) Esitamise päev	06.12.2005	
(28) Variantide arv	1	
(72) Autor	Davide MARIANI, SWATCHLAB, Via Archimede 6, IT-20129 Milano, IT	
(73) Omanik	SWATCH AG (SWATCH SA) (SWATCH LTD.), 94, Rue Jakob Stämpfli, CH-2502 BIENNE, CH	
WIPO Rahvusvah Tööstusdisainilahenduste Bülletääni nr, kus registreering on avaldatud	2005/12	

(54) **Nimetus** **Wristwatch**

(55) **Reproduksioon**

DM/067232-01



(11) Rahvusvah reg nr	DM/067233	(51) Klass: 10-02
(21) Rahvusvah reg jrk	H200600004	
(15) Registreeringu päev	06.12.2005	
(22) Esitamise päev	06.12.2005	
(28) Variantide arv	1	
(72) Autor	Léonie COCQUIO, DUPONT DESIGN SA, Route des Jeunes 33, CH-1227 CAROUGE, CH	
(73) Omanik	SWATCH AG (SWATCH SA) (SWATCH LTD.), 94, Rue Jakob Stämpfli, CH-2502 BIENNE, CH	
WIPO Rahvusvah Tööstusdisainilahenduste Bülletääni nr, kus registreering on avaldatud	2005/12	

(54) **Nimetus** **Wristwatch**

(55) **Reproduktsoon**

DM/067233-01



(11) Rahvusvah reg nr	DM/067244	(51) Klass: 10-02
(21) Rahvusvah reg jrk	H200600005	
(15) Registreeringu päev	06.12.2005	
(22) Esitamise päev	06.12.2005	
(28) Variantide arv	1	
(72) Autor	Andrea ARRIGONI, SWATCHLAB, Via Archimede 6, 20129 Milano, IT	
(73) Omanik	SWATCH AG (SWATCH SA) (SWATCH LTD.), 94, Rue Jakob Stämpfli, CH-2502 BIENNE, CH	
WIPO Rahvusvah Tööstusdisainilahenduste Bülletääni nr, kus registreering on avaldatud	2005/12	

(54) **Nimetus** **Wristwatch**

(55) **Reproduktsoon**

DM/067244-01



(11) Rahvusvah reg nr	DM/067245	(51) Klass: 10-02
(21) Rahvusvah reg jrk	H200600006	
(15) Registreeringu päev	06.12.2005	
(22) Esitamise päev	06.12.2005	
(28) Variantide arv	1	
(72) Autor	Arnaud BLASZCZYK, DUPONT DESIGN SA, route des Jeunes 33, CH-1227 Carouge, CH	
(73) Omanik	SWATCH AG (SWATCH SA) (SWATCH LTD.), 94, Rue Jakob Stämpfli, CH-2502 BIENNE, CH	
WIPO Rahvusvah Tööstusdisainilahenduste Bülletääni nr, kus registreering on avaldatud	2005/12	

(54) **Nimetus** **Wristwatch**

(55) **Reproduksioon**

DM/067245-01



(11) Rahvusvah reg nr	DM/067247	(51) Klass: 10-02
(21) Rahvusvah reg jrk	H200600007	
(15) Registreeringu päev	06.12.2005	
(22) Esitamise päev	06.12.2005	
(28) Variantide arv	1	
(72) Autor	Léonie COCQUIO, DUPONT DESIGN SA, route des Jeunes 33, CH-1227 CAROUGE, CH	
(73) Omanik	SWATCH AG (SWATCH SA) (SWATCH LTD.), 94, Rue Jakob Stämpfli, CH-2502 BIENNE, CH	
WIPO Rahvusvah Tööstusdisainilahenduste Bülletääni nr, kus registreering on avaldatud	2005/12	

(54) **Nimetus** **Wristwatch**

(55) **Reproduksioon**

DM/067247-01



(11) Rahvusvah reg nr	DM/067253	(51) Klass: 10-02
(21) Rahvusvah reg jrk	H200600008	
(15) Registreeringu päev	05.12.2005	
(22) Esitamise päev	05.12.2005	
(28) Variantide arv	1	
(72) Autor	Patrizia BISA, TORINO ORGANISING COMMITTEE C 80 Novara 96, IT-10152 TORINO, IT	
(73) Omanik	SWATCH AG (SWATCH SA) (SWATCH LTD.), 94, Rue Jakob Stämpfli, CH-2502 BIENNE, CH	
WIPO Rahvusvah Tööstusdisainilahenduste Bülletääni nr, kus registreering on avaldatud	2005/12	

(54) **Nimetus** **Wristwatch**

(55) **Reproduksioon**

DM/067253-01



(11) Rahvusvah reg nr	DM/067292	(51) Klass: 14-02
(21) Rahvusvah reg jrk	H200600009	
(15) Registreeringu päev	22.09.2005	
(22) Esitamise päev	22.09.2005	
(28) Variantide arv	6	
(72) Autor	Klaus Baumgartner, Sommerhofenstr. 53, D-71067 Sindelfingen, DE Jonas Vollmer, Senefelderstr. 78a, D-70176 Stuttgart, DE SIEMENS SCHWEIZ AG, Albisriederstrasse 245, CH-8047 Zürich, CH	
(73) Omanik		
WIPO Rahvusvah Tööstusdisainilahenduste		
Bülletääni nr, kus registreering on avaldatud	2005/12	

(54) **Nimetus** **Home automation devices**

(55) **Reproduktsoon**

DM/067292-01

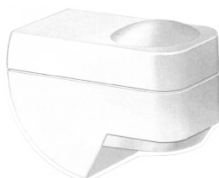
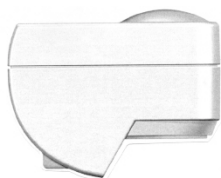

DM/067292-02

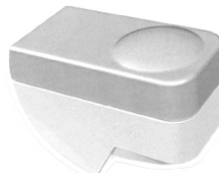

DM/067292-03



DM/067292-04



DM/067292-05

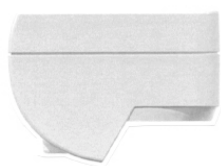

DM/067292-06

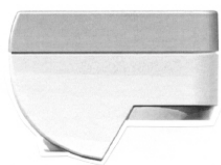

(11) Rahvusvah reg nr	DM/067303	(51) Klass: 10-02
(21) Rahvusvah reg jrk	H200600015	
(15) Registreeringu päev	22.12.2005	
(22) Esitamise päev	22.12.2005	
(28) Variantide arv	1	
(72) Autor	Danilo SALA, SWATCHLAB, Via Archimede 6, IT-20129 MILANO, IT	
(73) Omanik	SWATCH AG (SWATCH SA) (SWATCH LTD.), 94, Rue Jakob Stämpfli, CH-2502 BIENNE, CH	
WIPO Rahvusvah Tööstusdisainilahenduste Bülletääni nr, kus registreering on avaldatud	2005/12	

(54) **Nimetus** **Wristwatch**

(55) **Reproduksioon**

DM/067303-01



(11) Rahvusvah reg nr	DM/067305	(51) Klass: 10-02
(21) Rahvusvah reg jrk	H200600016	
(15) Registreeringu päev	22.12.2005	
(22) Esitamise päev	22.12.2005	
(28) Variantide arv	1	
(72) Autor	Rossana BOFFI, SWATCHLAB, Via Archimede 6, IT-20129 MILANO, IT	
(73) Omanik	SWATCH AG (SWATCH SA) (SWATCH LTD.), 94, Rue Jakob Stämpfli, CH-2502 BIENNE, CH	
WIPO Rahvusvah Tööstusdisainilahenduste Bülletääni nr, kus registreering on avaldatud	2005/12	

(54) **Nimetus** **Wristwatch**

(55) **Reproduktsoon**

DM/067305-01



(11) Rahvusvah reg nr	DM/067306	(51) Klass: 10-07
(21) Rahvusvah reg jrk	H200600017	
(15) Registreeringu päev	22.12.2005	
(22) Esitamise päev	22.12.2005	
(28) Variantide arv	1	
(72) Autor	Robert BERTRAND, Ch. Près-Guëttins 42, CH-2520 LA NEUVEVILLE, CH	
(73) Omanik	TISSOT S.A., chemin des Tourelles 17, CH-2400 LE LOCLE, CH	
WIPO Rahvusvah Tööstusdisainilahenduste Bülletääni nr, kus registreering on avaldatud	2005/12	

(54) **Nimetus** **Wristwatch case with band**

(55) **Reproduksioon**

DM/067306-01



(11) Rahvusvah reg nr	DM/067307	(51) Klass: 10-02
(21) Rahvusvah reg jrk	H200600018	
(15) Registreeringu päev	22.12.2005	
(22) Esitamise päev	22.12.2005	
(28) Variantide arv	1	
(72) Autor	Katia DE CONTI, DUPONT DESIGN SA, Route des Jeunes 33, CH-1227 CAROUGE, CH	
(73) Omanik	SWATCH AG (SWATCH SA) (SWATCH LTD.), 94, Rue Jakob Stämpfli, CH-2502 BIENNE, CH	
WIPO Rahvusvah Tööstusdisainilahenduste Bülletääni nr, kus registreering on avaldatud	2005/12	

(54) **Nimetus** **Wristwatch**

(55) **Reproduktsoon**

DM/067307-01



III. REGISTREERINGU KEHTIVUSE PIKENDAMINE

(11)	(18)		
00565	09.04.2011	00575	20.06.2011
00567	24.05.2011	00576	20.06.2011
00568	15.06.2011	00578	21.08.2011
00569	15.06.2011	00581	13.06.2011
00570	15.06.2011	00582	29.08.2011
00571	20.06.2011	00583	29.08.2011
00572	20.06.2011	00605	03.08.2011
00573	20.06.2011	00615	29.08.2011
00574	20.06.2011	00717	07.12.2011

XI. TÖÖSTUSDISAINILAHENDUSE KUSTUTAMINE REGISTRIST

"Tööstusdisaini kaitse seaduse" paragrahvi 77 lõike 1 alusel on registrist kustutatud järgmised tööstusdisainilahendused:

Reg nr	Kustutamise jõustumise päev
--------	-----------------------------

00506	07.11.2005
00511	23.10.2005
00520	18.12.2005
00525	08.01.2006
00529	19.12.2005
00559	04.12.2005

XII. LOENDID**REGISTREERITUD TÖÖSTUSDISAINILAHENDUSTE SÜSTEMAATILINE LOEND**

Rahvusvahelise klassifikatsiooni klass ja alaklass(id)	Registreerimis-taotluse number	Registreeringu number			
03-01	D200600002	01165	12-07	D200600029	01171
06-11	D200600030	01172	14-03	D200500079	01164
06-12	D200600030	01172	14-03	D200600016	01166
07-06	D200600023	01169	14-03	D200600017	01167
10-04	D200600029	01171	14-03	D200600018	01168
10-05	D200600029	01171	14-03	D200600026	01170
10-06	D200600029	01171	14-03	D200600029	01171

REGISTREERITUD TÖÖSTUSDISAINILAHENDUSTE REGISTREERIMISTAOTLUSTE NUMBRILINE LOEND

Registreerimis-taotluse number	Registreeringu number	Rahvusvahelise klassifikatsiooni klass(id) ja alaklass(id)			
D200500079	01164	14-03	D200600029	01171	10-04
D200600002	01165	03-01	D200600029	01171	10-05
D200600016	01166	14-03	D200600029	01171	10-06
D200600017	01167	14-03	D200600029	01171	12-07
D200600018	01168	14-03	D200600029	01171	14-03
D200600023	01169	07-06	D200600030	01172	06-11
D200600026	01170	14-03	D200600030	01172	06-12

AVALDATUD RAHVUSVAHELISE REGISTREERINGU REGISTREERIMISE OTSUSE TEADETE NUMBRILINE LOEND

DM/066322	DM/066728	DM/067074	DM/067247
DM/066339	DM/066729	DM/067088	DM/067253
DM/066432	DM/066732	DM/067117	DM/067292
DM/066450	DM/066760	DM/067118	DM/067303
DM/066528	DM/066822	DM/067119	DM/067305
DM/066668	DM/066824	DM/067232	DM/067306
DM/066673	DM/066844	DM/067233	DM/067307
DM/066678	DM/067072	DM/067244	
DM/066724	DM/067073	DM/067245	

XIII. TÖÖSTUSDISAINIALASED ÕIGUSAKTID JA MUU INFO**RIIKLIKUS PATENDIVOLNIKE REGISTRIS REGISTREERITUD PATENDIVOLNIKE NIMEKIRI**
(seisuga 15. juuni 2006)

Register on asutatud 1. septembril 2001. a Vabariigi Valitsuse 7. augusti 2001. a määrusega nr 271 "Riikliku patendivolinike registri asutamine ja registri pidamise põhimäärus" (RT I 2001, 70, 426) patendivoliniku seaduse § 21 alusel (RT I 2001, 27, 151).

TEGEVUSVALDKOND: KAUBAMÄRK, TÖÖSTUSDISAINILAHENDUS JA GEOGRAAFILINE TÄHIS**Arno ANIJALG****OÜ USTERVALL**

Raekoja plats 16
51004 Tartu
pk 21, 50002 Tartu
telefon: 744 1980
telefaks: 744 1785
e-post: anijalg@ustervall.ee
http://www.ustervall.ee
võõrkeeled: saksa, vene

Juhan HÄMMALOV**OÜ Intels**

Riia 11-3
51010 Tartu
telefon: 742 0401
telefaks: 742 0326
e-post: intelses@estpak.ee
võõrkeeled: inglise, saksa, vene

Aivo ARULA**Patendibüroo Käosaar & Co OÜ**

Tähe 94
50107 Tartu
telefon: 738 3051
telefaks: 738 3055
e-post: info@kaosaar.ee
http://www.kaosaar.ee
võõrkeeled: inglise, vene

Uno JÄÄGER**Inseneribüroo Uneko OÜ**

Rüütli 51a, 80010 Pärnu
telefon: 447 1021
telefaks: 447 1001
GSM: 515 1844
e-post: uno@estpak.ee
võõrkeeled: inglise, soome, vene

Martina BÖCKLER-LORVI**OÜ LASVET**

Suurtüki 4a, 10133 Tallinn
pk 3136, 10505 Tallinn
telefon: 640 6600
telefaks: 640 6604
e-post: lasvet@lasvet.ee
http://www.lasvet.ee
võõrkeeled: inglise, soome

Sirje KAHU**OÜ USTERVALL**

Raekoja plats 16
51004 Tartu
pk 21, 50002 Tartu
telefon: 744 1980
telefaks: 744 1785
e-post: skahu@ustervall.ee
http://www.ustervall.ee
võõrkeeled: inglise, vene

Indrek EELMETS**OÜ LASVET**

Suurtüki 4a, 10133 Tallinn
pk 3136, 10505 Tallinn
telefon: 640 6600
telefaks: 640 6604
e-post: lasvet@lasvet.ee
http://www.lasvet.ee
võõrkeeled: inglise, vene, soome

Lembit KALEV**Patendibüroo ROOSILLA OÜ**

Järveotsa tee 39-61
13520 Tallinn
telefon: 657 1722, 657 5381
telefaks: 657 5381
GSM: 511 9951
e-post: roosilla@roosilla.ee
http://www.roosilla.ee
võõrkeeled: inglise, vene

Alla HÄMMALOV**OÜ Intels**

Riia 11-3
51010 Tartu
telefon: 742 0401
telefaks: 742 0326
e-post: intelses@estpak.ee
võõrkeeled: inglise, poola, vene

Anneli KANG**OÜ Synest**

pk 977, 13402 Tallinn
telefon: 660 9786
telefaks: 660 9787
e-post: anneli@synest.ee
võõrkeeled: inglise, saksa, vene, prantsuse, soome, rootsi

Elle MELLIK	AAA Patendibüroo OÜ Tartu mnt 16 10117 Tallinn pk 3926, 10509 Tallinn telefon: 660 5910, 660 5911 telefaks: 660 5912 e-post: aaa@aaa.ee http://www.aaa.ee võõrkeeled: inglise, vene	Jaak OSTRAT	OÜ LASVET Suurtüki 4a, 10133 Tallinn pk 3136, 10505 Tallinn telefon: 640 6600 telefaks: 640 6604 e-post: lasvet@lasvet.ee http://www.lasvet.ee võõrkeeled: inglise, saksa, soome, vene
Lembit MITT	AAA Patendibüroo OÜ Tartu mnt 16 10117 Tallinn pk 3926, 10509 Tallinn telefon: 660 5910, 660 5911 telefaks: 660 5912 e-post: aaa@aaa.ee http://www.aaa.ee võõrkeeled: inglise, vene	Villu PAVELTS	OÜ LASVET Suurtüki 4a, 10133 Tallinn pk 3136, 10505 Tallinn telefon: 640 6600 telefaks: 640 6604 e-post: lasvet@lasvet.ee http://www.lasvet.ee võõrkeeled: inglise, soome, vene
Ott MOORLAT	OÜ Moorlat & Ko Patendibüroo pk 723, 12902 Tallinn telefon: 655 0450, 654 2844 telefaks: 654 2844 e-post: ott.moorlat@moorlat.ee http://www.moorlat.ee võõrkeeled: inglise, vene	Toom PUNGAS	OÜ Synest pk 977, 13402 Tallinn telefon: 660 9786 telefaks: 660 9787 e-post: toom@synest.ee võõrkeeled: inglise, saksa, soome, vene
Anfia MORNA	Patendibüroo TURVAJA OÜ Liivalaia 22, 10118 Tallinn telefon: 640 3109 telefaks: 640 3105 e-post: morna@turvaja.ee http://www.turvaja.ee võõrkeeled: inglise, vene	Kaie PUUR	Patendibüroo Käosaar & Co OÜ Tähe 94 50107 Tartu telefon: 738 3051 telefaks: 738 3055 e-post: info@kaosaar.ee http://www.kaosaar.ee võõrkeeled: inglise, vene
Tõnu NELSAS	AAA Patendibüroo OÜ Tartu mnt 16 10117 Tallinn pk 3926, 10509 Tallinn telefon: 660 5910, 660 5911 telefaks: 660 5912 e-post: aaa@aaa.ee http://www.aaa.ee võõrkeeled: inglise, vene, soome	Riina PÄRN	OÜ Intels Riia 11-3 51010 Tartu telefon: 742 0401 telefaks: 742 0326 e-post: intelses@estpak.ee võõrkeeled: inglise, vene
Jüri OLT	Patendibüroo Käosaar & Co OÜ Tähe 94, 50107 Tartu telefon: 738 3051 telefaks: 738 3055 e-post: info@kaosaar.ee http://www.kaosaar.ee võõrkeeled: inglise, saksa, soome, vene	Tarmo ROSMAN	Rosman ja Partnerid OÜ pk 652, 12602 Tallinn telefon: 656 1450 telefaks: 656 1450 e-post: tarman@cc.ttu.ee võõrkeeled: saksa, inglise, ungari, vene
		Arvo SALUMÄE	OÜ Amende Patendibüroo Raua 65 10152 Tallinn telefon: 648 6125 telefaks: 641 0174 e-post: amende@hot.ee võõrkeeled: inglise, saksa, soome, vene

Almar SEHVER**AAA Patendibüroo OÜ**

Tartu mnt 16
10117 Tallinn
pk 3926, 10509 Tallinn
telefon: 660 5910, 660 5911
telefaks: 660 5912
e-post: aaa@aaa.ee
http://www.aaa.ee
võõrkeeled: inglise, vene

Olga TREUFELDT**Patendibüroo TURVAJA OÜ**

Liivalaia 22
10118 Tallinn
telefon: 640 3109
telefaks: 640 3105
e-post: olga@turvaja.ee
http://www.turvaja.ee
võõrkeeled: inglise, vene

Harald TEHVER**Patendibüroo TURVAJA OÜ**

Liivalaia 22
10118 Tallinn
telefon: 640 3109
telefaks: 640 3105
e-post: tehver@turvaja.ee
http://www.turvaja.ee
võõrkeeled: inglise, saksa, vene

Enn URGAS**Patendibüroo TURVAJA OÜ**

Liivalaia 22
10118 Tallinn
telefon: 640 3109
telefaks: 640 3105
e-post: urgas@turvaja.ee
http://www.turvaja.ee
võõrkeeled: inglise, vene

Mari TOOMSOO**Patendibüroo Käosaar & Co OÜ**

Peterburi tee 46, 11415 Tallinn
telefon: 637 9484
telefaks: 637 9485
e-post: mari.toomsoo@kaosaar.ee
http://www.kaosaar.ee
võõrkeeled: inglise, soome

Juta-Maris UUSTALU**OÜ Amende Patendibüroo**

Raua 65
10152 Tallinn
telefon: 648 6125
telefaks: 641 0174
e-post: amende@hot.ee
võõrkeeled: inglise, vene

**LIST OF PATENT ATTORNEYS, REGISTERED IN
THE ESTONIAN STATE REGISTER OF PATENT ATTORNEYS
(by 15 June 2006)**

Register is established on September 1st 2001

FIELD OF ACTIVITY: TRADEMARKS, INDUSTRIAL DESIGNS AND GEOGRAPHICAL INDICATIONS

Arno ANIJALG	USTERVALL Ltd. Raekoja plats 16 51004 Tartu, Estonia P.O. Box 21 50002 Tartu, Estonia Phone: +372 744 1980 Fax: +372 744 1785 E-mail: anijalg@ustervall.ee Http://www.ustervall.ee German, Russian, Estonian	Juhan HÄMMALOV	Intels Ltd. Riia Str. 11-3 51010 Tartu, Estonia Phone: +372 742 0401 Fax: +372 742 0326 E-mail: intelses@estpak.ee English, German, Russian, Estonian
Aivo ARULA	Patent Agency Käosaar & Co Tähe Str. 94 50107 Tartu, Estonia Phone: +372 738 3051 Fax: +372 738 3055 E-mail: info@kaosaar.ee Http://www.kaosaar.ee English, Russian, Estonian	Uno JÄÄGER	Inseneribüroo Uneko Ltd. Rüütli 51a 80010 Pärnu, Estonia Phone: +372 447 1021 Fax: +372 447 1001 GSM: +372 515 1844 E-mail: uno@estpak.ee English, Finnish, Russian, Estonian
Martina BÖCKLER-LORVI	Lasvet Ltd. P.O. Box 3136 10505 Tallinn, Estonia Phone: +372 640 6600 Fax: +372 640 6604 E-mail: lasvet@lasvet.ee Http://www.lasvet.ee English, Finnish, Estonian	Sirje KAHU	USTERVALL Ltd. Raekoja plats 16 51004 Tartu, Estonia P.O. Box 21 50002 Tartu, Estonia Phone: +372 744 1980 Fax: +372 744 1785 E-mail: skahu@ustervall.ee Http://www.ustervall.ee English, Russian, Estonian
Indrek EELMETS	Lasvet Ltd. P.O. Box 3136 10505 Tallinn, Estonia Phone: +372 640 6600 Fax: +372 640 6604 E-mail: lasvet@lasvet.ee Http://www.lasvet.ee English, Finnish, Russian, Estonian	Lembit KALEV	Patent Bureau ROOSILLA Ltd. Järveotsa Road 39-61 13520 Tallinn, Estonia Phone: +372 657 1722 +372 657 5381 Fax: +372 657 5381 GSM: +372 511 9951 E-mail: roosilla@roosilla.ee Http://www.roosilla.ee English, Russian, Estonian
Alla HÄMMALOV	Intels Ltd. Riia Str. 11-3 51010 Tartu, Estonia Phone: +372 742 0401 Fax: +372 742 0326 E-mail: intelses@estpak.ee English, Polish, Russian, Estonian	Anneli KANG	Synest Ltd. P.O. Box 977 13402 Tallinn, Estonia Phone: +372 660 9786 Fax: +372 660 9787 E-mail: anneli@synest.ee English, German, Russian, French, Finnish, Swedish, Estonian

- Urmast KAULER** **Patendibüroo TURVAJA OÜ**
Liivalaia 22
10118 Tallinn, Estonia
Phone: +372 640 3109
Fax: +372 640 3105
E-mail: kauler@turvaja.ee
Http://www.turvaja.ee
English, Russian, Finnish,
Estonian
- Urmast KERNU** **AAA Legal Services**
Tartu Road 16
10117 Tallinn, Estonia
P.O. Box 3926
10509 Tallinn, Estonia
Phone: +372 660 5910
+372 660 5911
Fax: +372 660 5912
E-mail: aaa@aaa.ee
Http://www.aaa.ee
English, German, Finnish,
Russian, Estonian
- Marina KESSELMAN** **Kesna Ltd.**
Tedre Str. 77-52
10616 Tallinn, Estonia
Phone: +372 660 8068
Fax: +372 660 8069
E-mail: kesna@kesna.ee
Http://www.kesna.ee
English, German, Russian,
Estonian
- Ljubov KESSELMAN** **Kesna Ltd.**
Tedre Str. 77-52
10616 Tallinn, Estonia
Phone: +372 660 8068
Fax: +372 660 8069
E-mail: kesna@kesna.ee
Http://www.kesna.ee
English, Russian, Estonian
- Heinu KOITEL** **Patent & Trademark Agency
Koitel**
Tartu Road 65
10115 Tallinn, Estonia
P.O. Box 1759
10902 Tallinn, Estonia
Phone: +372 603 3260
Fax: +372 603 3261
E-mail: koitel@koitel.ee
Http://www.koitel.ee
English, Finnish, Russian,
Estonian
- Raivo KOITEL** **Patent & Trademark Agency
Koitel**
Tartu Road 65
10115 Tallinn, Estonia
P.O. Box 1759
10902 Tallinn, Estonia
Phone: +372 603 3260
Fax: +372 603 3261
E-mail: koitel@koitel.ee
Http://www.koitel.ee
English, Finnish, Russian,
Estonian
- Mart Enn KOPPEL** **Patent Bureau Koppel**
Kajaka 4-10
11317 Tallinn, Estonia
Phone: +372 677 4136
Fax: +372 677 4138
E-mail: info@koppelpb.com
Http://www.koppelpb.com
English, Russian, Finnish,
Estonian
- Heinrich KRUPP** **Patendibüroo TURVAJA OÜ**
Liivalaia 22
10118 Tallinn, Estonia
Phone: +372 640 3109
Fax: +372 640 3105
E-mail: turvaja@turvaja.ee
Http://www.turvaja.ee
German, Russian, Estonian
- Jüri KÄOSAAR** **Patent Agency Käosaar & Co**
Tähe Str. 94
50107 Tartu, Estonia
Phone: +372 738 3051
Fax: +372 738 3055
E-mail: info@kaosaar.ee
Http://www.kaosaar.ee
English, Russian, Estonian
- Kalev KÄOSAAR** **Patent Agency Käosaar & Co**
Peterburi Road 46
11415 Tallinn, Estonia
Phone: +372 637 9484
Fax: +372 637 9485
E-mail:
kalev.kaosaar@kaosaar.ee
Http://www.kaosaar.ee
English, Russian, Estonian

- Reet MAASIKAMÄE** **Patent Bureau Kaitsepurus Ltd.**
Mulla Str. 4-3
10611 Tallinn, Estonia
Phone: +372 673 9097
+372 633 2798
Fax: +372 677 4844
E-mail: purus@online.ee
purus@hot.ee
Http://www.hot.ee/purus/
English, Russian, Estonian
- Raivo MATSOO** **RM Hirvela Patent Bureau Ltd**
Saku 15, 11314 Tallinn, Estonia
Phone: +372 614 0816
Fax: +372 614 0818
E-mail: hirvela@hirvela.ee
English, Russian, Estonian
- Elle MELLIK** **AAA Legal Services**
Tartu Road 16
10117 Tallinn, Estonia
P.O. Box 3926
10509 Tallinn, Estonia
Phone: +372 660 5910
+372 660 5911
Fax: +372 660 5912
E-mail: aaa@aaa.ee
Http://www.aaa.ee
English, Russian, Estonian
- Lembit MITT** **AAA Legal Services**
Tartu Road 16
10117 Tallinn, Estonia
P.O. Box 3926
10509 Tallinn, Estonia
Phone: +372 660 5910
+372 660 5911
Fax: +372 660 5912
E-mail: aaa@aaa.ee
Http://www.aaa.ee
English, Russian, Estonian
- Ott MOORLAT** **Moorlat & Co Ltd. Patent Bureau**
P.O. Box 723
12902 Tallinn, Estonia
Phone: +372 655 0450
+372 654 2844
Fax: +372 654 2844
E-mail: ott.moorlat@moorlat.ee
Http://www.moorlat.ee
English, Russian, Estonian
- Anfia MORNA**
- Tõnu NELSAS**
- Jüri OLT**
- Jaak OSTRAT**
- Villu PAVELTS**
- Toom PUNGAS**
- Patendibüroo TURVAJA OÜ**
Liivalaia 22
10118 Tallinn, Estonia
Phone: +372 640 3109
Fax: +372 640 3105
E-mail: morna@turvaja.ee
Http://www.turvaja.ee
English, Russian, Estonian
- AAA Legal Services**
Tartu Road 16
10117 Tallinn, Estonia
P.O. Box 3926
10509 Tallinn, Estonia
Phone: +372 660 5910
+372 660 5911
Fax: +372 660 5912
E-mail: aaa@aaa.ee
Http://www.aaa.ee
English, Russian, Finnish, Estonian
- Patent Agency Käosaar & Co**
Tähe Str. 94
50107 Tartu, Estonia
Phone: +372 738 3051
Fax: +372 738 3055
E-mail: info@kaosaar.ee
Http://www.kaosaar.ee
English, German, Finnish, Russian, Estonian
- Lasvet Ltd.**
P.O. Box 3136
10505 Tallinn, Estonia
Phone: +372 640 6600
Fax: +372 640 6604
E-mail: lasvet@lasvet.ee
Http://www.lasvet.ee
English, German, Finnish, Russian, Estonian
- Lasvet Ltd.**
P.O. Box 3136
10505 Tallinn, Estonia
Phone: +372 640 6600
Fax: +372 640 6604
E-mail: lasvet@lasvet.ee
Http://www.lasvet.ee
English, Finnish, Russian, Estonian
- Synest Ltd.**
P.O. Box 977
13402 Tallinn, Estonia
Phone: +372 660 9786
Fax: +372 660 9787
E-mail: toom@synest.ee
English, German, Finnish, Russian, Estonian

- Kaie PUUR** **Patent Agency Käosaar & Co**
Tähe Str. 94
50107 Tartu, Estonia
Phone: +372 738 3051
Fax: +372 738 3055
E-mail: info@kaosaar.ee
Http://www.kaosaar.ee
English, Russian, Estonian
- Harald TEHVER** **Patendibüroo TURVAJA OÜ**
Liivalaia 22
10118 Tallinn, Estonia
Phone: +372 640 3109
Fax: +372 640 3105
E-mail: tehver@turvaja.ee
Http://www.turvaja.ee
English, German, Russian,
Estonian
- Riina PÄRN** **Intels Ltd.**
Riia Str. 11-3
51010 Tartu, Estonia
Phone: +372 742 0401
Fax: +372 742 0326
E-mail: intelses@estpak.ee
English, Russian,
Estonian
- Mari TOOMSOO** **Patent Agency Käosaar & Co**
Peterburi Str. 46
11415 Tallinn, Estonia
Phone: +372 637 9484
Fax: +372 637 9485
E-mail: mari.toomsoo@kaosaar.ee
Http://www.kaosaar.ee
English, Finnish, Estonian
- Tarmo ROSMAN** **Rosman and Partners Ltd.**
P.O. Box 652
12602 Tallinn, Estonia
Phone: +372 656 1450
Fax: +372 656 1450
E-mail: tarman@cc.ttu.ee
German, English, Hungarian,
Russian, Estonian
- Olga TREUFELDT** **Patendibüroo TURVAJA OÜ**
Liivalaia 22
10118 Tallinn, Estonia
Phone: +372 640 3109
Fax: +372 640 3105
E-mail: olga@turvaja.ee
Http://www.turvaja.ee
English, Russian, Estonian
- Arvo SALUMÄE** **AMENDE Patent Agency Ltd.**
Raua 65, 10152 Tallinn, Estonia
Phone: +372 648 6125
Fax: +372 641 0174
E-mail: amende@hot.ee
English, German, Finnish,
Russian, Estonian
- Enn URGAS** **Patendibüroo TURVAJA OÜ**
Liivalaia 22
10118 Tallinn, Estonia
Phone: +372 640 3109
Fax: +372 640 3105
E-mail: urgas@turvaja.ee
Http://www.turvaja.ee
English, Russian, Estonian
- Almar SEHVER** **AAA Legal Services**
Tartu Road 16
10117 Tallinn, Estonia
P.O. Box 3926
10509 Tallinn, Estonia
Phone: +372 660 5910
+372 660 5911
Fax: +372 660 5912
E-mail: aaa@aaa.ee
Http://www.aaa.ee
English, Russian, Estonian
- Juta-Maris UUSTALU** **AMENDE Patent Agency Ltd.**
Raua 65, 10152 Tallinn, Estonia
Phone: +372 648 6125
Fax: +372 641 0174
E-mail: amende@hot.ee
English, Russian, Estonian