



EESTI VABARIIK

**T** **EESTI**  
**TÖÖSTUSDISAINI-**  
**LAHENDUSE LEHT**



PATENDIAMETI AMETLIK VÄLJAANNE

**3**  
**2005**  
TALLINN



ISSN 1406-376X

EESTI VABARIIK

**T** **EESTI**  
**TÖÖSTUSDISAINI-**  
**LAHENDUSE LEHT**

**PATENDIAMETI  
AMETLIK VÄLJAANNE**

**VIII aastakäik**

**Käesolevas numbris  
esitatud andmed  
loetakse avaldatuks  
15. augustil 2005. a.**

**3**  
**2005**  
AUGUST  
TALLINN

Eesti Tööstusdisainilahenduse Lehte antakse välja tööstusdisaini kaitse seaduse (jõustunud 11.01.1998) alusel.  
The Estonian Industrial Design Gazette is the official publication of the Estonian Patent Office.  
Published under Industrial Design Protection Law of the Republic of Estonia (coming into force 11 January 1998).  
Date of publication of the data presented in this issue - 15 August 2005.

Patendiameti  
infoosakond  
Toompuiestee 7  
15041 Tallinn  
Tel 627 7907  
Faks 627 7943  
E-post Info@epa.ee

The Information Department  
of the Estonian Patent Office  
Toompuiestee 7  
15041 Tallinn, ESTONIA  
Phone +372 627 7907  
Fax +372 627 7943  
E-mail Info@epa.ee

Levitaja

Eesti Patendiraamatukogu  
Olevimägi 8/10  
10123 Tallinn  
Tel 641 1248  
Faks 641 1018  
E-post patent@patentlib.ee

Distributor

Estonian Patent Library  
Olevimägi 8/10  
10123 Tallinn, ESTONIA  
Phone +372 641 1248  
Fax +372 641 1018  
E-mail patent@patentlib.ee

## SISUKORD

Andmete identifitseerimise rahvusvahelised numberkoodid (INID-koodid) . . . . .	4
Riikide, teiste ühenduste ja valitsustevaheliste organisatsioonide koodid . . . . .	5
I. REGISTREERITUD TÖÖSTUSDISAINILAHENDUSED . . . . .	6
II. RAHVUSVAHELISELT REGISTREERITUD TÖÖSTUSDISAINILAHENDUSED . . . . .	54
III. REGISTREERINGU KEHTIVUSE PIKENDAMINE . . . . .	80
IV. TÖÖSTUSDISAINILAHENDUSE ÜLEMINEK . . . . .	80
V. REGISTREERINGU JAGAMINE . . . . .	-
VI. MUUD REGISTREERINGU ANDMETE MUUDATUSED . . . . .	80
VII. REGISTREERINGU ANDMETE PARANDUSED . . . . .	-
VIII. TÖÖSTUSDISAINILAHENDUSE LITSENTSIDE REGISTREERIMINE . . . . .	-
IX. TÖÖSTUSDISAINILAHENDUSE PANTIDE REGISTREERIMINE . . . . .	-
X. TUNNISTUSE DUPLIKAADI VÄLJAANDMINE . . . . .	-
XI. TÖÖSTUSDISAINILAHENDUSE KUSTUTAMINE REGISTRIST . . . . .	80
XII. LOENDID . . . . .	81
Registreeritud tööstusdisainilahenduste süstemaatiline loend . . . . .	81
Registreeritud tööstusdisainilahenduste registreerimistaotluste numbriline loend . . . . .	81
Avaldatud rahvusvahelise registreeringu registreerimise otsuse teadete numbriline loend . . . . .	82
XIII. TÖÖSTUSDISAINIALASED ÕIGUSAKTID JA MUU INFO . . . . .	83
Riiklikus patendivolinike registris registreeritud patendivolinike nimekiri . . . . .	83

## CONTENTS

Internationally Agreed Numbers for the Identification of Data (INID Codes) . . . . .	4
List of Codes of States, Other Entities and Intergovernmental Organizations . . . . .	5
I. REGISTERED INDUSTRIAL DESIGNS . . . . .	6
II. INTERNATIONALLY REGISTERED INDUSTRIAL DESIGNS . . . . .	54
III. EXTENSION OF THE REGISTRATION . . . . .	80
IV. TRANSFER OF INDUSTRIAL DESIGN . . . . .	80
V. DIVISION OF THE REGISTRATION. . . . .	-
VI. OTHER AMENDMENTS TO REGISTRATION DATA . . . . .	80
VII. CORRECTIONS TO REGISTRATION DATA . . . . .	-
VIII. REGISTERING OF LICENSES OF INDUSTRIAL DESIGN . . . . .	-
IX. REGISTERING OF PLEDGES OF INDUSTRIAL DESIGN . . . . .	-
X. ISSUE OF A COPY OF THE INDUSTRIAL DESIGN CERTIFICATE . . . . .	-
XI. DELETION OF INDUSTRIAL DESIGN FROM THE REGISTER . . . . .	80
XII. LISTS . . . . .	81
Systematic List of Registered Industrial Designs . . . . .	81
Numerical List of Registration Applications of Registered Industrial Designs . . . . .	81
Numerical List of Published Notices of Decisions on Registration of the International Registration . . . . .	82
XIII. LEGAL ACTS AND INFORMATION CONCERNING INDUSTRIAL DESIGNS . . . . .	83
List of Patent Attorneys, Registered in the Estonian State Register of Patent Attorneys . . . . .	87

**ANDMETE IDENTIFITSEERIMISE  
RAHVUSVAHELISED NUMBERKOODID  
(INID-KOODID)  
WIPO Standard ST. 80**

**INTERNATIONALLY AGREED NUMBERS FOR  
THE IDENTIFICATION OF DATA  
(INID CODES)  
WIPO Standard ST. 80**

(11) Registreeringu number	(11) Number of the Registration
(15) Registreerimise kuupäev	(15) Date of the Registration
(18) Registreeringu kehtivuse lõppemise kuupäev	(18) Expected expiration date of the registration
(21) Registreerimistaotluse number	(21) Application Number
(22) Registreerimistaotluse esitamise kuupäev	(22) Application Filing Date
(24) Registreeringu kehtivuse alguse kuupäev	(24) Date from which the Industrial Design right has effected
(28) Variantide arv	(28) Number of Industrial Designs included in the application
(30) Prioriteet	(30) Priority
(51) Rahvusvahelise klassifikatsiooni klassi ja alaklassi number	(51) International Classification for Industrial Designs (class and subclass of the Locarno Classification)
(54) Tööstusdisainilahenduse nimetus	(54) Title of the Industrial Design
(55) Tööstusdisainilahenduse reproduktsioon	(55) Reproduction of the Industrial Design
(72) Tööstusdisainilahenduse autor(id)	(72) Author(s) of Industrial Design
(73) Tööstusdisainilahenduse omanik(ud)	(73) Proprietor(s) of Industrial Design
(74) Patendivolinik või ühine esindaja	(74) Patent Attorney or Common Representative

**RIIKIDE, TEISTE ÜHENDUSTE JA VALITSUSTEVAAHELISTE  
ORGANISATSIOONIDE KOODID**

AD	Andorra	DO	Dominikaani	IT	Itaalia	PT	Portugal
AE	Araabia		Vabariik	JM	Jamaica	PW	Belau
	Ühendemiraadid	DZ	Alžeeria	JO	Jordania	PY	Paraguay
AF	Afganistan	EA	Euraasia	JP	Jaapan	QA	Katar
AG	Antigua ja Barbuda		Patendiorganisat-	KE	Kenya	RO	Rumeenia
AI	Anguilla		sioon (EAPO)	KG	Kõrgõzstan	RU	Venemaa
AL	Albaania	EC	Ecuador	KH	Kambodža	RW	Rwanda
AM	Armeenia	EE	Eesti	KI	Kiribati	SA	Saudi Araabia
AN	Hollandi Antillid	EG	Egiptus	KM	Komoorid	SB	Salomoni Saared
AO	Angola	EH	Lääne-Sahara	KN	Saint Kitts ja Nevis	SC	Seišellid
AP	Aafrika Regionaalne	EM	Siseturu	KP	Põhja-Korea	SD	Sudaan
	Tööstusomandi Orga-		Ühtlustamise	KR	Lõuna-Korea	SE	Rootsi
	nisatsioon (ARIPO)		Amet (kaubamärgid	KW	Kuveit	SG	Singapur
AR	Argentina		ja tööstusdisaini-	KY	Kaimanisaared	SH	Saint Helena
AS	Ameerika Samoa		lahendused)(OHIM)	KZ	Kasahstan	SI	Sloveenia
AT	Austria	EP	Euroopa	LA	Laos	SK	Slovakkia
AU	Austraalia		Patendiamet (EPO)	LB	Liibanon	SL	Sierra Leone
AW	Aruba	ER	Eritrea	LC	Saint Lucia	SM	San Marino
AZ	Aserbaidžaan	ES	Hispaania	LI	Liechtenstein	SN	Senegal
BA	Bosnia ja	ET	Etiopia	LK	Sri Lanka	SO	Somaalia
	Hertsegoviina	FI	Soome	LR	Libeeria	SR	Suriname
BB	Barbados	FJ	Fidži	LS	Lesotho	ST	São Tomé ja Príncipe
BD	Bangladesh	FK	Falklandi (Malviini)	LT	Leedu	SV	El Salvador
BE	Belgia		saared	LU	Luksemburg	SY	Süüria
BF	Burkina Faso	FM	Mikroneesia	LV	Läti	SZ	Svaasimaa
BG	Bulgaaria	FO	Fääri saared	LY	Liibüa	TC	Turks ja Caicos
BH	Bahrein	FR	Prantsusmaa	MA	Maroko	TD	Tšaad
BI	Burundi	GA	Gabon	MC	Monaco	TG	Togo
BJ	Benin	GB	Ühendkuningriik	MD	Moldova	TH	Tai
BM	Bermuda		(Suurbritannia)	MG	Madagaskar	TJ	Tadžikistan
BN	Brunei	GC	Pärsia Lahe	MH	Marshalli Saared	TM	Türkmenistan
BO	Boliivia		Koostöönõukogu	MK	Makedoonia	TN	Tuneesia
BR	Brasiilia	GD	Grenada	ML	Mali	TO	Tonga
BS	Bahama	GE	Gruusia	MM	Myanmar (Birma)	TL	Ida-Timor
BT	Bhutan	GH	Ghana	MN	Mongoolia	TR	Türgi
BV	Bouvet' saar	GI	Gibraltar	MO	Macao	TT	Trinidad ja Tobago
BW	Botswana	GL	Gröönimaa	MP	Põhja-Mariaanid	TV	Tuvalu
BX	Beneluxi	GM	Gambia	MR	Mauritaania	TW	Taiwan (Hiina provints)
	Kaubamärgiamet	GN	Guinea	MS	Montserrat	TZ	Tansaania
	(BBM) ja Beneluxi	GQ	Ekvatoriaal-Guinea	MT	Malta	UA	Ukraina
	Tööstusdisainilahen-	GR	Kreeka	MU	Mauritius	UG	Uganda
	duste Amet (BBDM)	GS	Lõuna-Georgia ja	MV	Maldiivid	US	Ameerika
BY	Valgevene		Lõuna-Sandwichi	MW	Malawi		Ühendriigid
BZ	Belize		saared	MX	Mehhiko	UY	Uruguay
CA	Kanada	GT	Guatemala	MY	Malaisia	UZ	Usbekistan
CF	Kesk-Aafrika	GW	Guinea-Bissau	MZ	Mosambiik	VA	Vatikan (Püha Tool)
	Vabariik	GY	Guyana	NA	Namiibia	VC	Saint Vincent ja
CG	Kongo	HK	Hongkong	NE	Niger		Grenadiinid
CH	Šveits	HN	Honduras	NG	Nigeeria	VE	Venezuela
CI	Côte d'Ivoire	HR	Horvaatia	NI	Nicaragua	VG	Neitsisaared
CK	Cooki saared	HT	Haiti	NL	Holland	VN	Vietnam
CL	Tšiili	HU	Ungari	NO	Norra	VU	Vanuatu
CM	Kamerun	IB	Ülemaailmse	NP	Nepal	WO	Ülemaailmne
CN	Hiina		Intellektuaalomandi	NR	Nauru		Intellektuaalomandi
CO	Kolumbia		Organisatsiooni	NZ	Uus-Meremaa		Organisatsioon
CR	Costa Rica		(WIPO) Rahvus-	OA	Aafrika Intellektuaal-		(WIPO) (Rahvus-
CS	Serbia ja Montenegro		vaheline Büroo		omandi Organisat-		vaheline Büroo)
CU	Kuuba	ID	Indoneesia		sioon (OAPI)	WS	Samoa
CV	Cabo Verde	IE	Iiri	OM	Omaan	YE	Jeemen
CY	Küpros	IL	Iisrael	PA	Panama	ZA	Lõuna-Aafrika Vabariik
CZ	Tšehhi	IM	Man'i saar	PE	Peruu	ZM	Sambia
DE	Saksamaa	IN	India	PG	Paapua Uus-Guinea	ZR	Zaire
DJ	Djibouti	IQ	Iraak	PH	Filipiinid	ZW	Zimbabwe
DK	Taani	IR	Iraan	PK	Pakistan		
DM	Dominica	IS	Island	PL	Poola		

## **I. REGISTREERITUD TÖÖSTUSDISAINILAHENDUSED**

Avaldatakse "Tööstusdisaini kaitse seaduse" § 55<sup>1</sup> lõike 7 alusel.

Patendiamet ei ole kontrollinud tööstusdisainilahenduse uudsust ja eristatavust tulenevalt "Tööstusdisaini kaitse seaduse" § 31 lõike 2 punktist 1.

- (11) **Registreeringu number** **01070** (51) Klass: **09-03**
- (21) **Taotluse number** D200500018
- (15) **Registreerimise päev** 15.08.2005
- (22) **Esitamise päev** 01.04.2005
- (24) **Registreeringu kehtivuse alguse päev** 01.04.2005
- (18) **Registreeringu kehtivuse lõppemise päev** 01.04.2010
- (28) **Variantide arv** 1
- (72) **Autor** Hanno Niinepuu, Sõõru 38, 13516 Tallinn, EE
- (73) **Omanik** AS Eesti Munatooted, Saha tee 18, Loo, 74201 Harju maakond, Jõelähtme vald, EE
- (74) **Patendivolinik või ühine esindaja** Lembit Kalev

(54) **Nimetus** **Pakend kujundusmotiiviga**

(55) **Reproduktsoon**

01070-01

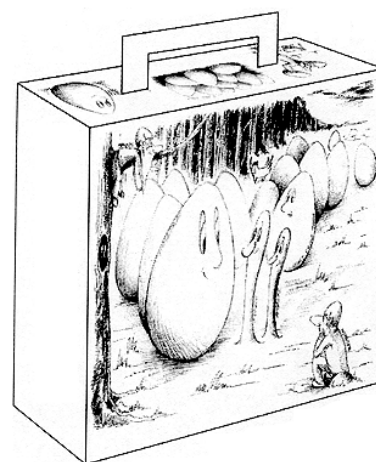
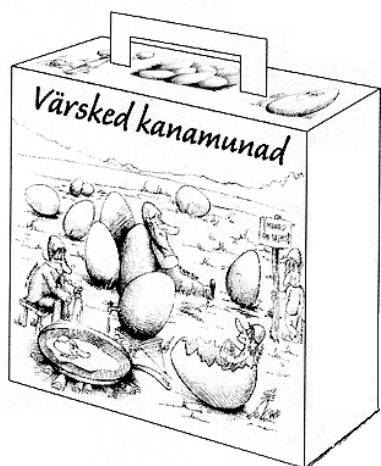



(11) Registreeringu number	<b>01071</b>	(51) Klass: <b>12-16</b>
(21) Taotluse number	D200500019	
(15) Registreerimise päev	15.08.2005	
(22) Esitamise päev	05.04.2005	
(24) Registreeringu kehtivuse alguse päev	05.04.2005	
(18) Registreeringu kehtivuse lõppemise päev	05.04.2010	
(28) Komplektide arv	1	
(72) Autor	Mart Kuusk, Härjapea 14-6, 10319 Tallinn, EE	
(73) Omanik	Konesko Autotarvik OÜ, Aiandi tee 21, Viimsi, 74001 Harju maakond, EE	
(74) Patendivolinik või ühine esindaja	Lembit Mitt	

(54) Nimetus **Kaitseraud-lisatulede kanduri komplekt sõidukile**

(55) Reproduktsoon

01071-01

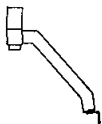
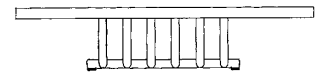
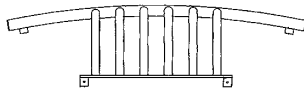
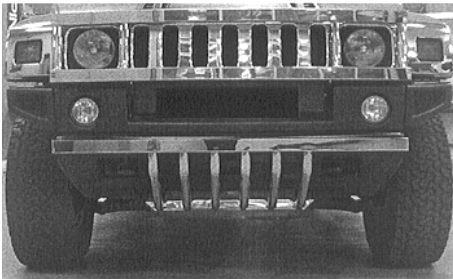

- (11) **Registreeringu number** **01072** (51) Klass: **09-01**
- (21) **Taotluse number** D200500020
- (15) **Registreerimise päev** 15.08.2005
- (22) **Esitamise päev** 12.04.2005
- (24) **Registreeringu kehtivuse alguse päev** 12.04.2005
- (18) **Registreeringu kehtivuse lõppemise päev** 12.04.2010
- (28) **Variantide arv** 1
- (72) **Autor** Dainius Krivickas, AB "Kalnapilio-Tauro grup.", Taikos al. 1, LT-5300 Panev.,žys, LT
- (73) **Omanik** AKCIN *f* BENDROV *f* KALNAPILIO-TAURO GRUP *f*, Taikos al. 1, LT-5300 Panev.,žys, LT
- (74) **Patendivolinik või ühine esindaja** Urmas Kernu
- (54) **Nimetus** **Pudel**
- (55) **Reproduktsoon**

01072-01



(11) Registreeringu number	<b>01073</b>	(51) Klass: <b>23-02, 24-01</b>
(21) Taotluse number	D200500021	
(15) Registreerimise päev	15.08.2005	
(22) Esitamise päev	13.04.2005	
(24) Registreeringu kehtivuse alguse päev	13.04.2005	
(18) Registreeringu kehtivuse lõppemise päev	13.04.2010	
(28) Variantide arv	1	
(72) Autor	Andri Sinka, Piirimäe 15, Tănassilma küla, Saku vald, 76401 Harju maakond, EE Sten Ader, Piirimäe 15, Tănassilma küla, Saku vald, 76401 Harju maakond, EE	
(73) Omanik	NEOQI AS, Piirimäe 15, Tănassilma küla, Saku vald, 76401 Harju maakond, EE	
(74) Patendivolinik või ühine esindaja	Mart Enn Koppel	

(54) Nimetus **Multifunktsionaalne teraapiakapsel**

(55) Reproduktsoon

01073-01

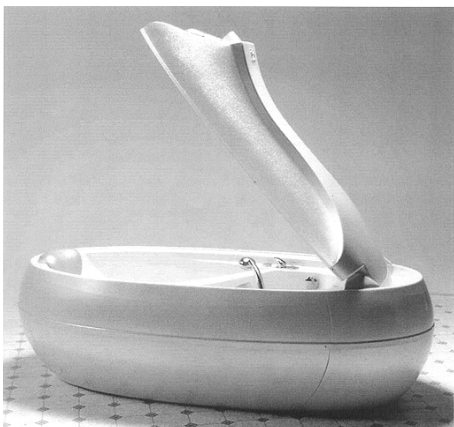
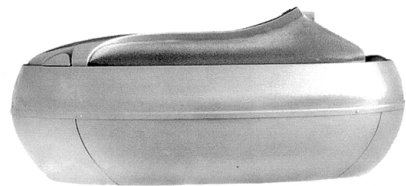
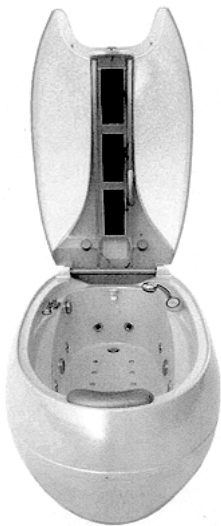

(11) Registreeringu number	<b>01074</b>	(51) Klass: <b>09-01</b>
(21) Taotluse number	D200500005	
(15) Registreerimise päev	15.08.2005	
(22) Esitamise päev	15.02.2005	
(24) Registreeringu kehtivuse alguse päev	15.02.2005	
(18) Registreeringu kehtivuse lõppemise päev	15.02.2010	
(28) Variantide arv	2	
(72) Autor	<i>Autori andmeid ei avalikustata</i>	
(73) Omanik	Saku Õlletehase AS, Saku, 75501 Harju maakond, EE	
(74) Patendivolinik või ühine esindaja	Ott Moorlat	

(54) Nimetus **Pudel**

(55) Reproduktsoon

01074-01

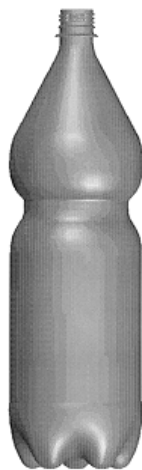
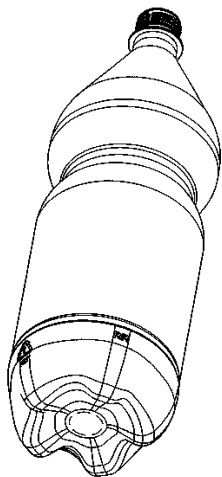

---

01074-02

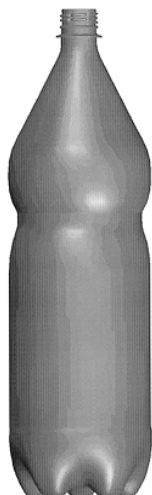

(11) Registreeringu number	<b>01075</b>	(51) Klass: <b>14-03</b>
(21) Taotluse number	D200500015	
(15) Registreerimise päev	15.08.2005	
(22) Esitamise päev	15.03.2005	
(24) Registreeringu kehtivuse alguse päev	15.03.2005	
(18) Registreeringu kehtivuse lõppemise päev	15.03.2010	
(28) Variantide arv	1	
(30) Prioriteediandmed	M20040148, 16.09.2004, FI	
(72) Autor	Shiho Nakajima, 4-2-13-701 Todoroki, Setagaya-ku, 158-0082 Tokyo, JP	
(73) Omanik	Nokia Corporation, Keilalahdentie 4, FIN-02150 Espoo, FI	
(74) Patendivolinik või ühine esindaja	Kalev Käosaar	

(54) Nimetus **Käsitelefoni klaviatuuri klahvide paigutus / klaviatuur**

(55) Reproduktsoon

01075-01

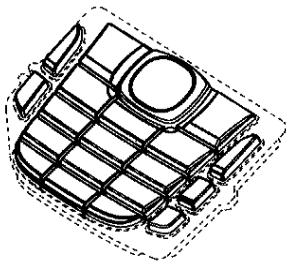
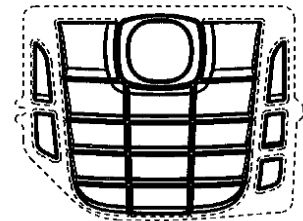
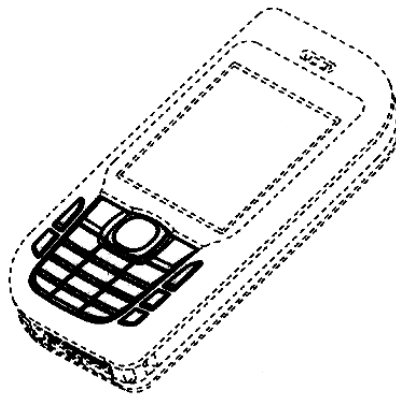
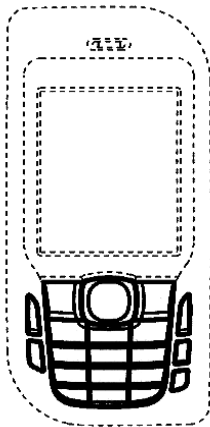

(11) **Registreeringu number** **01076**

(51) Klass: **14-03**

(21) **Taotluse number** D200500017

(15) **Registreerimise päev** 15.08.2005

(22) **Esitamise päev** 15.03.2005

(24) **Registreeringu kehtivuse alguse päev** 15.03.2005

(18) **Registreeringu kehtivuse lõppemise päev** 15.03.2010

(28) **Variantide arv** 1

(30) **Prioriteediandmed** M20040148, 16.09.2004, FI

(72) **Autor** Shiho Nakajima, 4-2-13-701 Todoroki, Setagaya-ku, 158-0082 Tokyo, JP

(73) **Omanik** Nokia Corporation, Keilalahdentie 4, FIN-02150 Espoo, FI

(74) **Patendivolinik või ühine esindaja** Kalev Käosaar

(54) **Nimetus** **Käsitelefoni esipaneel / esiosa**

(55) **Reproduktsoon**

01076-01

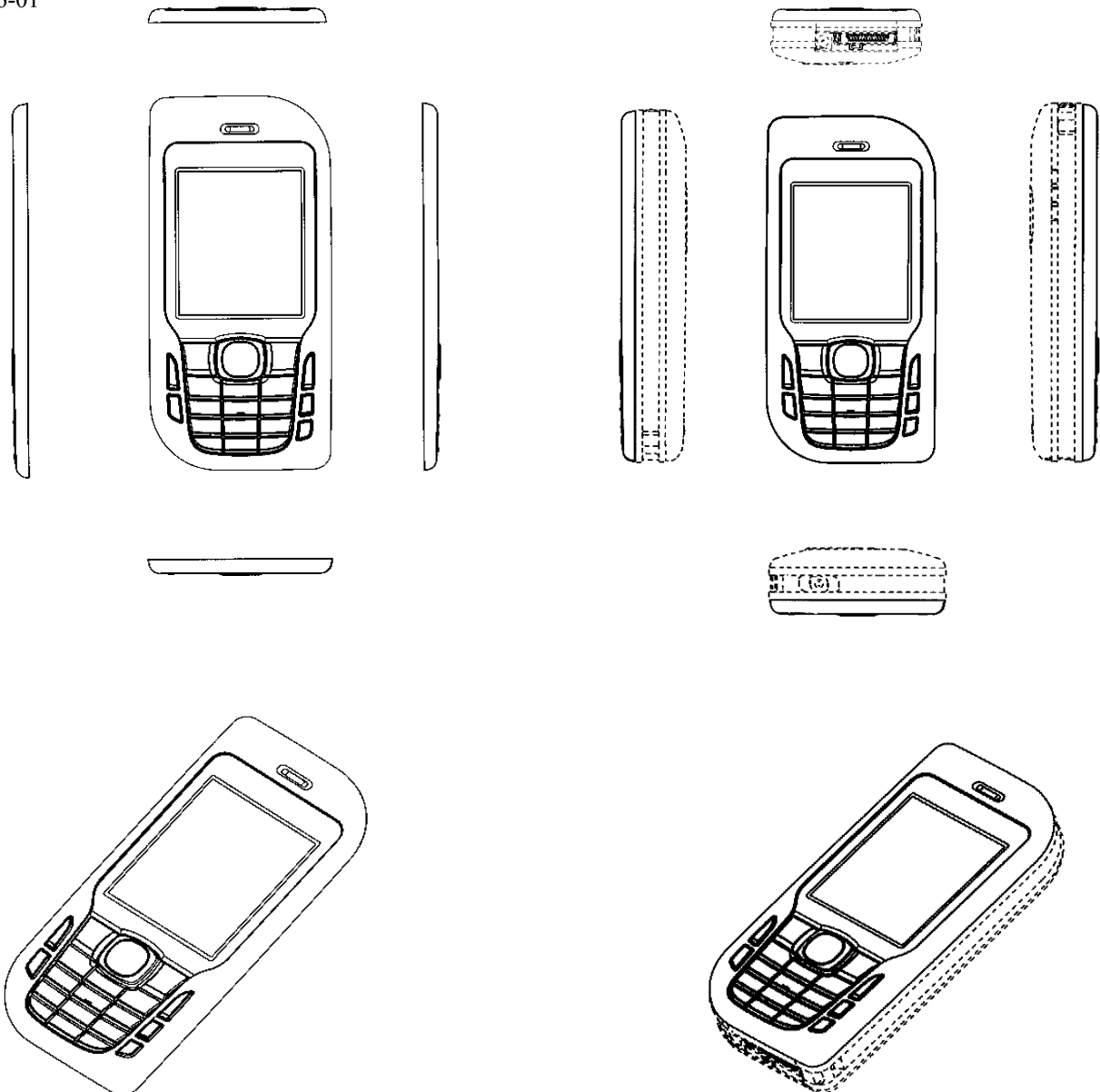

(11) **Registreeringu number** **01077**

(51) Klass: **06-01**

(21) **Taotluse number** D200500022

(15) **Registreerimise päev** 15.08.2005

(22) **Esitamise päev** 19.04.2005

(24) **Registreeringu kehtivuse alguse päev** 19.04.2005

(18) **Registreeringu kehtivuse lõppemise päev** 19.04.2010

(28) **Variantide arv** 1

(72) **Autor** *Autori andmeid ei avalikustata*

(73) **Omanik** AS Veeseadmed, Kadaka tee 32, 10621 Tallinn, EE

(54) **Nimetus** **Pink "1934"**

(55) **Reproduktsoon**

01077-01

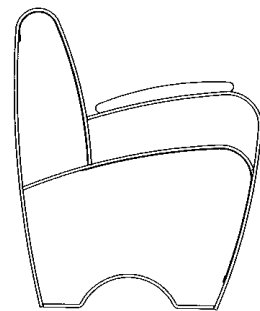
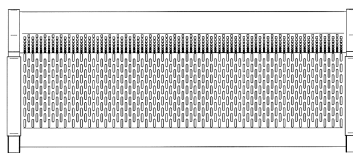
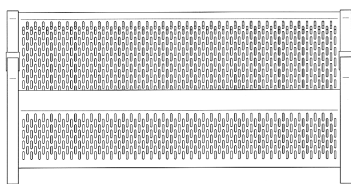
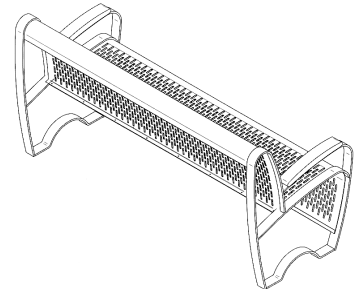
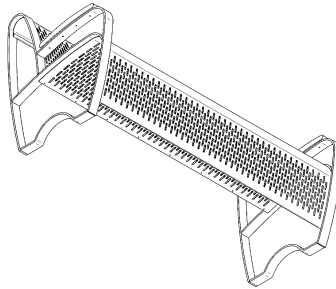
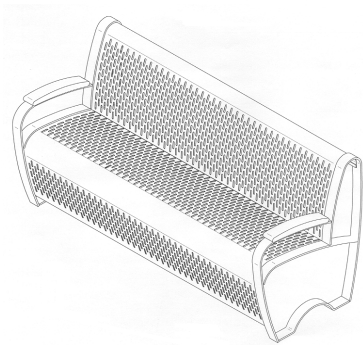

(11) Registreeringu number **01078**

(51) Klass: **09-09**

(21) Taotluse number D200500023

(15) Registreerimise päev 15.08.2005

(22) Esitamise päev 19.04.2005

(24) Registreeringu kehtivuse alguse päev 19.04.2005

(18) Registreeringu kehtivuse lõppemise päev 19.04.2010

(28) Variantide arv 1

(72) Autor *Autori andmeid ei avalikustata*

(73) Omanik AS Veeseadmed, Kadaka tee 32, 10621 Tallinn, EE

(54) Nimetus **Prügikast "Coloumn"**

(55) Reproduktsoon

01078-01

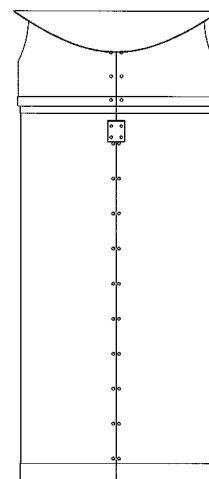
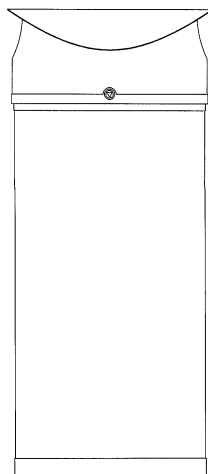
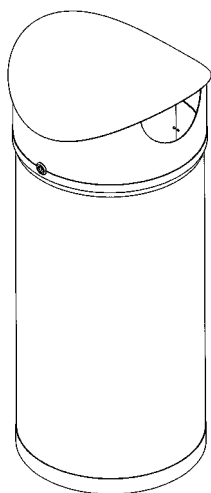



(11) Registreeringu number **01079**

(51) Klass: **06-01**

(21) Taotluse number D200500024

(15) Registreerimise päev 15.08.2005

(22) Esitamise päev 19.04.2005

(24) Registreeringu kehtivuse alguse päev 19.04.2005

(18) Registreeringu kehtivuse lõppemise päev 19.04.2010

(28) Variantide arv 1

(72) Autor *Autori andmeid ei avalikustata*

(73) Omanik AS Veeseadmed, Kadaka tee 32, 10621 Tallinn, EE

(54) Nimetus **Pink "Roma"**

(55) Reproduktsoon

01079-01

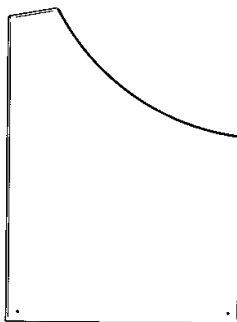
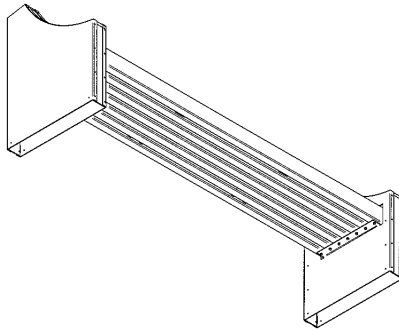
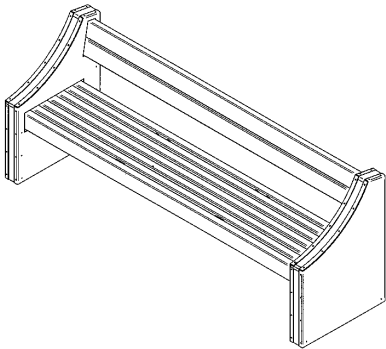

(11) Registreeringu number **01080**

(51) Klass: **09-09**

(21) Taotluse number D200500025

(15) Registreerimise päev 15.08.2005

(22) Esitamise päev 19.04.2005

(24) Registreeringu kehtivuse alguse päev 19.04.2005

(18) Registreeringu kehtivuse lõppemise päev 19.04.2010

(28) Variantide arv 3

(72) Autor *Autori andmeid ei avalikustata*

(73) Omanik AS Veeseadmed, Kadaka tee 32, 10621 Tallinn, EE

(54) Nimetus **Prügikast "Cube"**

(55) Reproduktsoon

01080-01

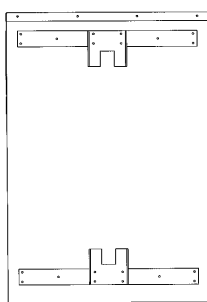
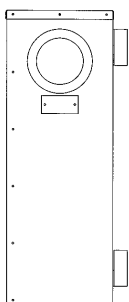
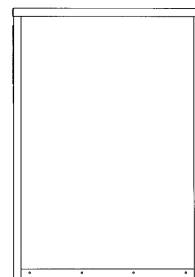
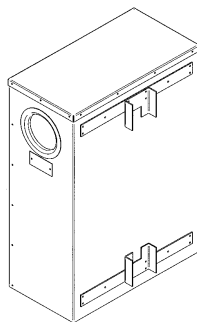
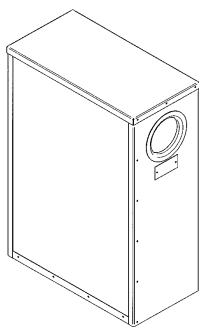

01080-02

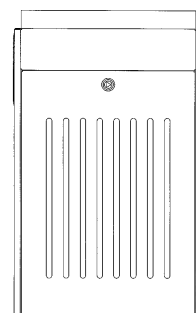
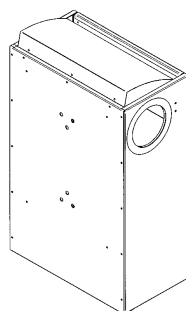
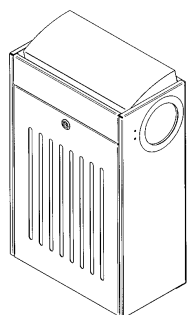

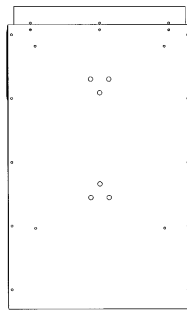

01080-03

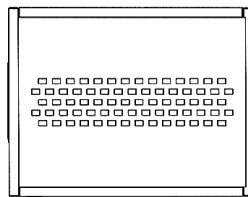
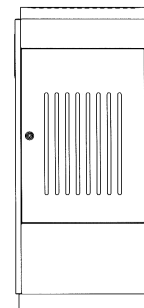
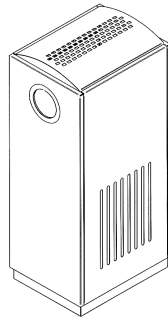
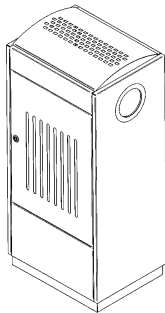

(11) Registreeringu number	<b>01081</b>	(51) Klass: <b>06-01</b>
(21) Taotluse number	D200500026	
(15) Registreerimise päev	15.08.2005	
(22) Esitamise päev	19.04.2005	
(24) Registreeringu kehtivuse alguse päev	19.04.2005	
(18) Registreeringu kehtivuse lõppemise päev	19.04.2010	
(28) Variantide arv	1	
(72) Autor	<i>Autori andmeid ei avalikustata</i>	
(73) Omanik	AS Veeseadmed, Kadaka tee 32, 10621 Tallinn, EE	

(54) Nimetus **Pink "Peigne"**

(55) Reproduktsoon

01081-01

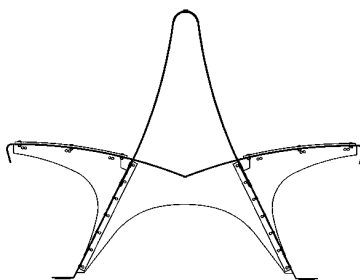
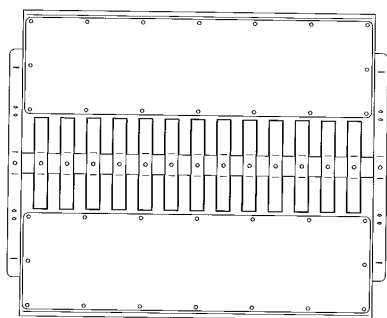
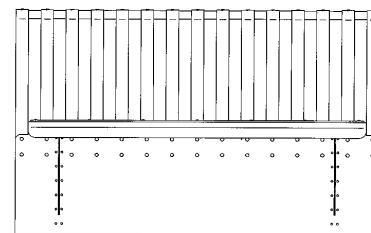
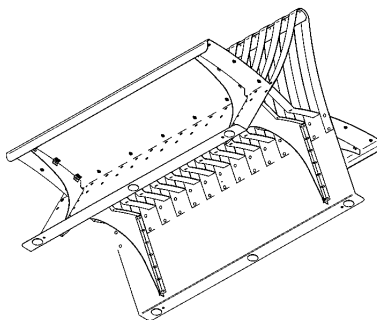
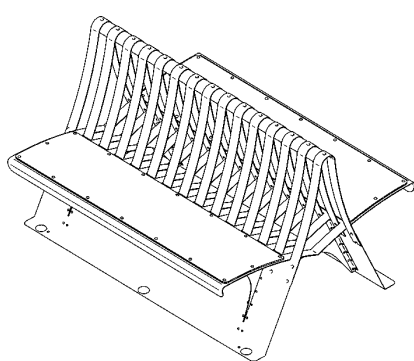

(11) **Registreeringu number** **01082**

(51) Klass: **06-01**

(21) **Taotluse number** D200500029

(15) **Registreerimise päev** 15.08.2005

(22) **Esitamise päev** 19.04.2005

(24) **Registreeringu kehtivuse alguse päev** 19.04.2005

(18) **Registreeringu kehtivuse lõppemise päev** 19.04.2010

(28) **Variantide arv** 1

(72) **Autor** *Autori andmeid ei avalikustata*

(73) **Omanik** AS Veeseadmed, Kadaka tee 32, 10621 Tallinn, EE

(54) **Nimetus** **Pink "Nippon"**

(55) **Reproduktsoon**

01082-01

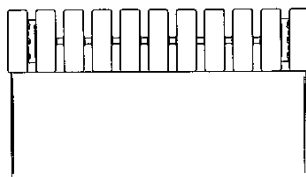
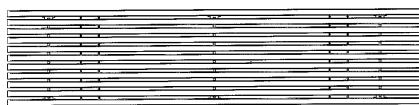
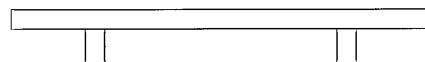
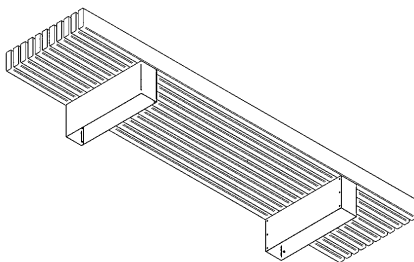
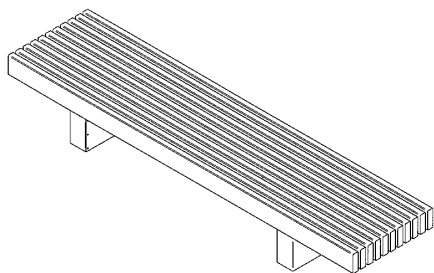

(11) Registreeringu number	<b>01083</b>	(51) Klass: <b>06-01</b>
(21) Taotluse number	D200500027	
(15) Registreerimise päev	15.08.2005	
(22) Esitamise päev	19.04.2005	
(24) Registreeringu kehtivuse alguse päev	19.04.2005	
(18) Registreeringu kehtivuse lõppemise päev	19.04.2010	
(28) Variantide arv	1	
(72) Autor	<i>Autori andmeid ei avalikustata</i>	
(73) Omanik	AS Veeseadmed, Kadaka tee 32, 10621 Tallinn, EE	

(54) Nimetus **Pink "Suisse"**

(55) Reproduktsoon

01083-01

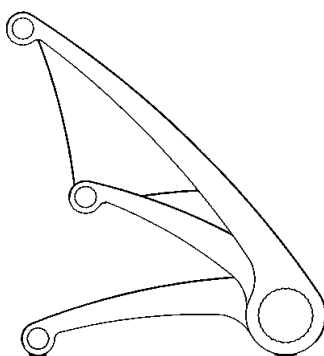
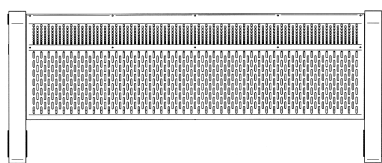
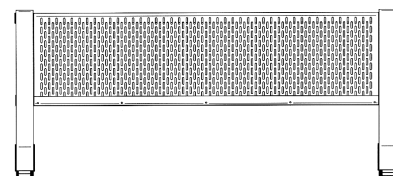
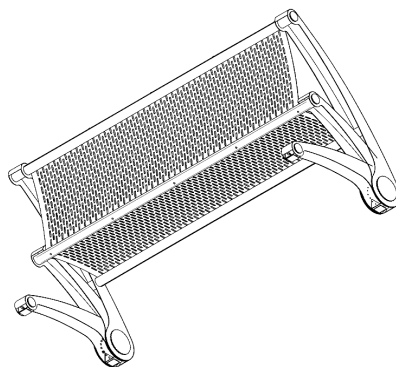
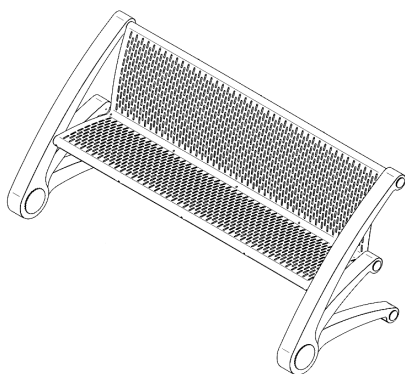

(11) **Registreeringu number** **01084**

(51) Klass: **23-01**

(21) **Taotluse number** D200500030

(15) **Registreerimise päev** 15.08.2005

(22) **Esitamise päev** 19.04.2005

(24) **Registreeringu kehtivuse alguse päev** 19.04.2005

(18) **Registreeringu kehtivuse lõppemise päev** 19.04.2010

(28) **Variantide arv** 1

(72) **Autor** *Autori andmeid ei avalikustata*

(73) **Omanik** AS Veeseadmed, Kadaka tee 32, 10621 Tallinn, EE

(54) **Nimetus** **Tuletõrjehüdrant II**

(55) **Reproduktsoon**

01084-01

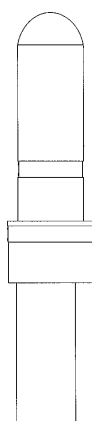
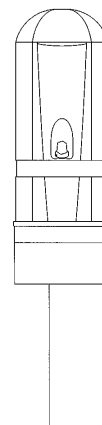
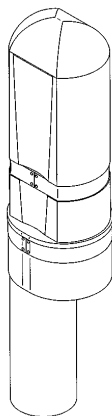
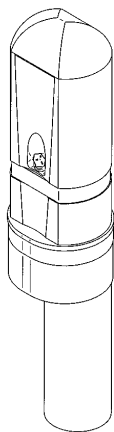

(11) **Registreeringu number** **01085**

(51) Klass: **23-01**

(21) **Taotluse number** D200500031

(15) **Registreerimise päev** 15.08.2005

(22) **Esitamise päev** 19.04.2005

(24) **Registreeringu kehtivuse alguse päev** 19.04.2005

(18) **Registreeringu kehtivuse lõppemise päev** 19.04.2010

(28) **Variantide arv** 1

(72) **Autor** *Autori andmeid ei avalikustata*

(73) **Omanik** AS Veeseadmed, Kadaka tee 32, 10621 Tallinn, EE

(54) **Nimetus** **Tuletõrjehüdrant I**

(55) **Reproduktsoon**

01085-01

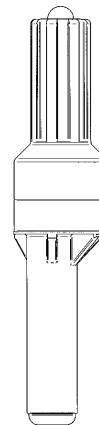
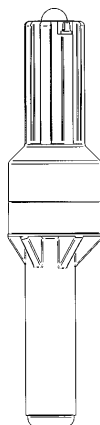
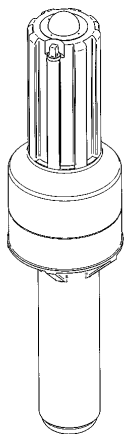



(11) Registreeringu number **01086**

(51) Klass: **27-03**

(21) Taotluse number D200500032

(15) Registreerimise päev 15.08.2005

(22) Esitamise päev 19.04.2005

(24) Registreeringu kehtivuse alguse päev 19.04.2005

(18) Registreeringu kehtivuse lõppemise päev 19.04.2010

(28) Variantide arv 1

(72) Autor *Autori andmeid ei avalikustata*

(73) Omanik AS Veeseadmed, Kadaka tee 32, 10621 Tallinn, EE

(54) Nimetus **Tuhatoos**

(55) Reproduktsoon

01086-01

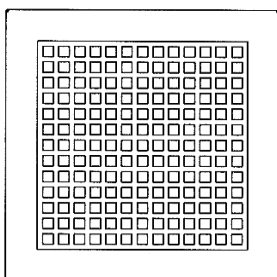
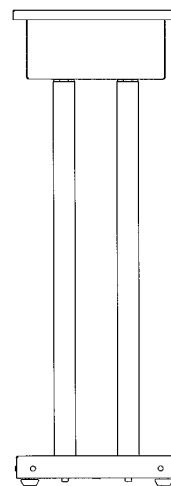
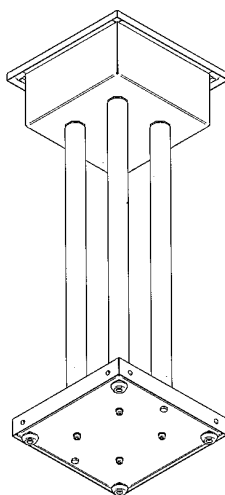
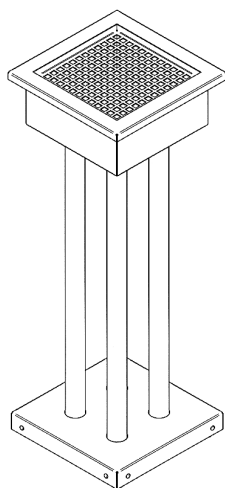

- (11) **Registreeringu number** **01087**
- (21) **Taotluse number** D200500028
- (15) **Registreerimise päev** 15.08.2005
- (22) **Esitamise päev** 19.04.2005
- (24) **Registreeringu kehtivuse alguse päev** 19.04.2005
- (18) **Registreeringu kehtivuse lõppemise päev** 19.04.2010
- (28) **Variantide arv** 1
- (72) **Autor** *Autori andmeid ei avalikustata*
- (73) **Omanik** AS Veeseadmed, Kadaka tee 32, 10621 Tallinn, EE

(51) Klass: **23-01**

(54) **Nimetus** **Veevõtupost**

(55) **Reproduktsoon**

01087-01

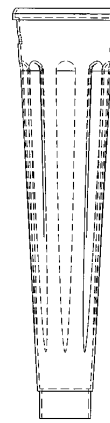
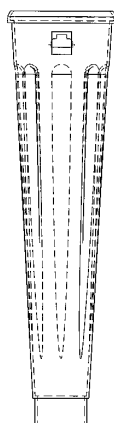

(11) Registreeringu number **01088**

(51) Klass: **06-01**

(21) Taotluse number D200500033

(15) Registreerimise päev 15.08.2005

(22) Esitamise päev 19.04.2005

(24) Registreeringu kehtivuse alguse päev 19.04.2005

(18) Registreeringu kehtivuse lõppemise päev 19.04.2010

(28) Variantide arv 1

(72) Autor *Autori andmeid ei avalikustata*

(73) Omanik AS Veeseadmed, Kadaka tee 32, 10621 Tallinn, EE

(54) Nimetus **Pink "Roma X"**

(55) Reproduktsoon

01088-01

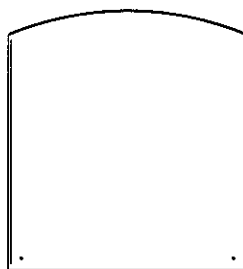
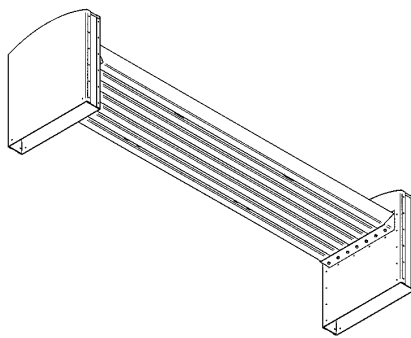
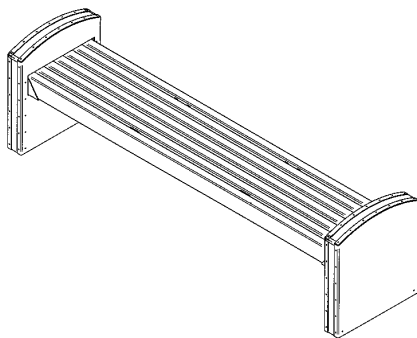

(11) Registreeringu number **01089**

(51) Klass: **06-01**

(21) Taotluse number D200500034

(15) Registreerimise päev 15.08.2005

(22) Esitamise päev 19.04.2005

(24) Registreeringu kehtivuse alguse päev 19.04.2005

(18) Registreeringu kehtivuse lõppemise päev 19.04.2010

(28) Variantide arv 1

(72) Autor *Autori andmeid ei avalikustata*

(73) Omanik AS Veeseadmed, Kadaka tee 32, 10621 Tallinn, EE

(54) Nimetus **Pink "Pont"**

(55) Reproduktsoon

01089-01

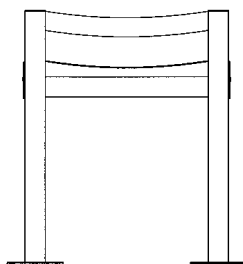
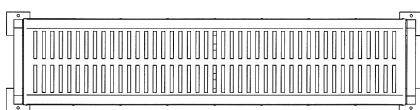
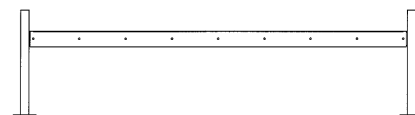
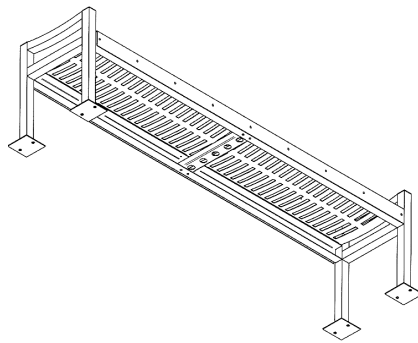
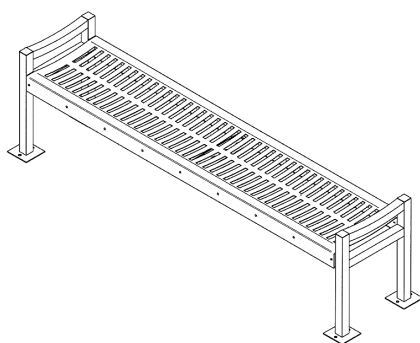

(11) **Registreeringu number** **01090**

(51) Klass: **06-01**

(21) **Taotluse number** D200500035

(15) **Registreerimise päev** 15.08.2005

(22) **Esitamise päev** 19.04.2005

(24) **Registreeringu kehtivuse alguse päev** 19.04.2005

(18) **Registreeringu kehtivuse lõppemise päev** 19.04.2010

(28) **Variantide arv** 1

(72) **Autor** *Autori andmeid ei avalikustata*

(73) **Omanik** AS Veeseadmed, Kadaka tee 32, 10621 Tallinn, EE

(54) **Nimetus** **Pink "Separement"**

(55) **Reproduktsoon**

01090-01

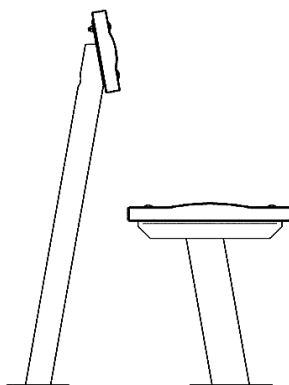
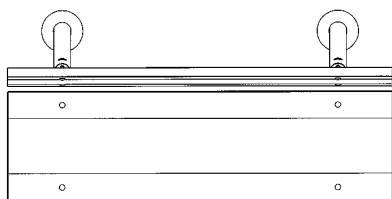
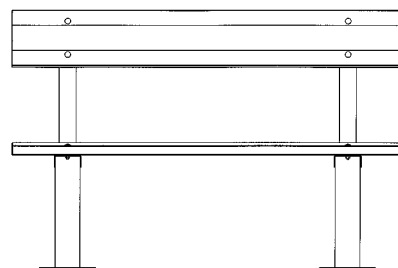
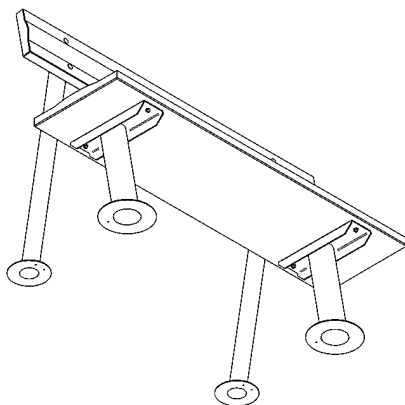
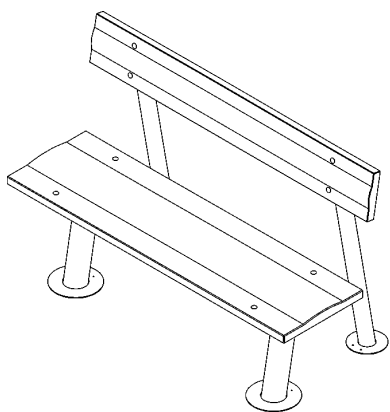

(11) Registreeringu number	<b>01091</b>	(51) Klass: <b>09-09</b>
(21) Taotluse number	D200500036	
(15) Registreerimise päev	15.08.2005	
(22) Esitamise päev	19.04.2005	
(24) Registreeringu kehtivuse alguse päev	19.04.2005	
(18) Registreeringu kehtivuse lõppemise päev	19.04.2010	
(28) Variantide arv	1	
(72) Autor	<i>Autori andmeid ei avalikustata</i>	
(73) Omanik	AS Veeseadmed, Kadaka tee 32, 10621 Tallinn, EE	

(54) Nimetus **Prügikast "Net"**

(55) Reproduktsoon

01091-01

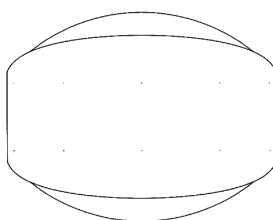
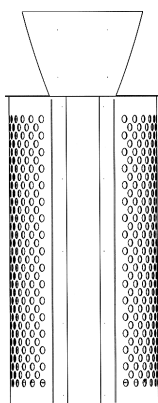
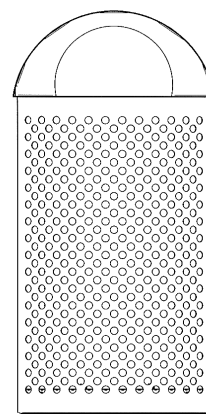
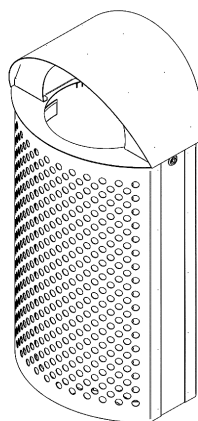
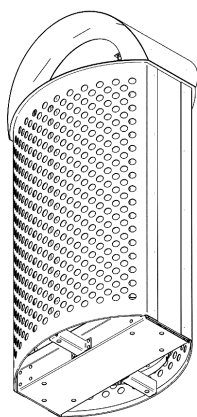

(11) **Registreeringu number** **01092**

(51) Klass: **09-09**

(21) **Taotluse number** D200500037

(15) **Registreerimise päev** 15.08.2005

(22) **Esitamise päev** 19.04.2005

(24) **Registreeringu kehtivuse alguse päev** 19.04.2005

(18) **Registreeringu kehtivuse lõppemise päev** 19.04.2010

(28) **Variantide arv** 1

(72) **Autor** *Autori andmeid ei avalikustata*

(73) **Omanik** AS Veeseadmed, Kadaka tee 32, 10621 Tallinn, EE

(54) **Nimetus** **Prügikast "Dog Station"**

(55) **Reproduktsoon**

01092-01

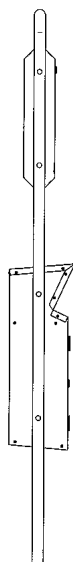
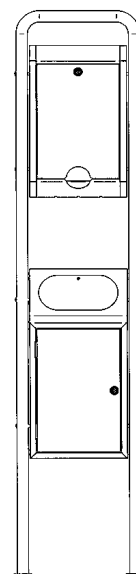
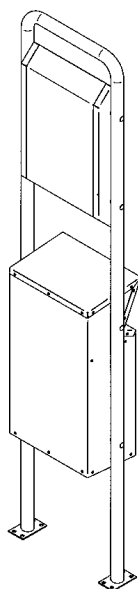
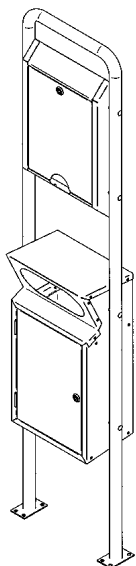

(11) Registreeringu number	<b>01093</b>	(51) Klass: <b>06-01</b>
(21) Taotluse number	D200500038	
(15) Registreerimise päev	15.08.2005	
(22) Esitamise päev	19.04.2005	
(24) Registreeringu kehtivuse alguse päev	19.04.2005	
(18) Registreeringu kehtivuse lõppemise päev	19.04.2010	
(28) Variantide arv	1	
(72) Autor	<i>Autori andmeid ei avalikustata</i>	
(73) Omanik	AS Veeseadmed, Kadaka tee 32, 10621 Tallinn, EE	

(54) Nimetus **Pink "1920"**

(55) Reproduktsoon

01093-01

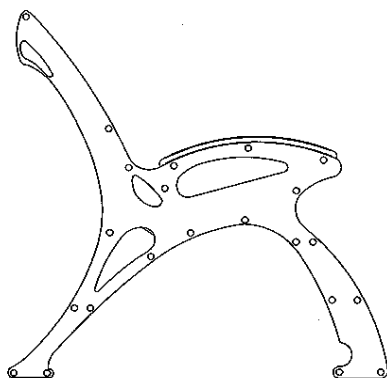
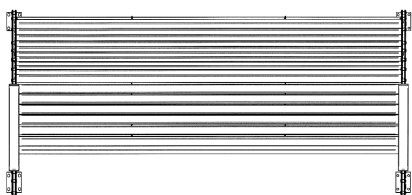
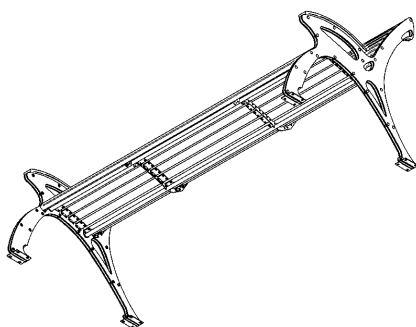
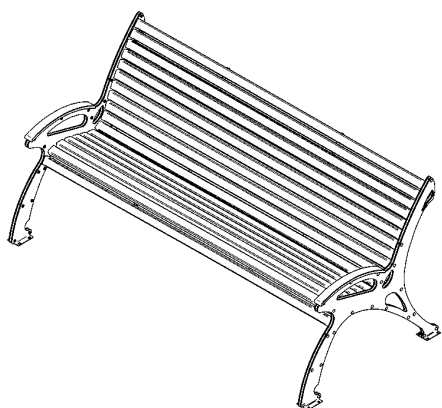



- (11) **Registreeringu number** **01094**
- (21) **Taotluse number** D200500039
- (15) **Registreerimise päev** 15.08.2005
- (22) **Esitamise päev** 19.04.2005
- (24) **Registreeringu kehtivuse alguse päev** 19.04.2005
- (18) **Registreeringu kehtivuse lõppemise päev** 19.04.2010
- (28) **Variantide arv** 1
- (72) **Autor** *Autori andmeid ei avalikustata*
- (73) **Omanik** AS Veeseadmed, Kadaka tee 32, 10621 Tallinn, EE

(51) Klass: **09-09**(54) **Nimetus** **Prügikast "Viking"**(55) **Reproduktsoon**

01094-01

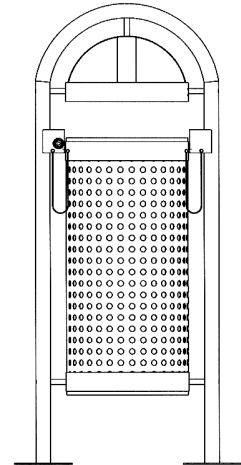
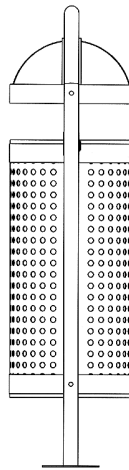
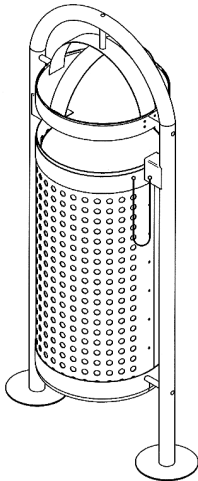

(11) **Registreeringu number** **01095**

(51) Klass: **14-03**

(21) **Taotluse number** D200500006

(15) **Registreerimise päev** 15.08.2005

(22) **Esitamise päev** 15.02.2005

(24) **Registreeringu kehtivuse alguse päev** 15.02.2005

(18) **Registreeringu kehtivuse lõppemise päev** 15.02.2010

(28) **Variantide arv** 1

(30) **Prioriteediandmed** 29/211,454, 17.08.2004, US

(72) **Autor** Shunjiro Eguchi, Otavantie 3 A 25, FI Helsinki, FI

(73) **Omanik** Nokia Corporation, Keilalahdentie 4, FIN-02150 Espoo, FI

(74) **Patendivolinik või ühine esindaja** Kaie Puur

(54) **Nimetus** **Käsitelefon**

(55) **Reproduktsoon**

01095-01

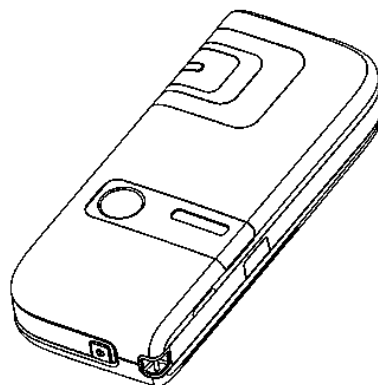
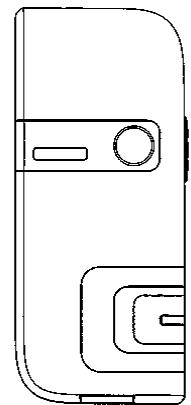
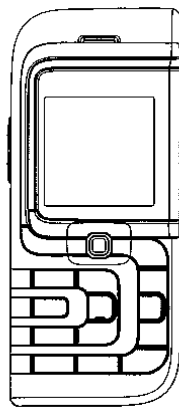
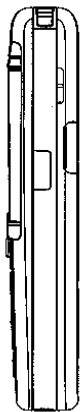

(11) Registreeringu number	<b>01096</b>	(51) Klass: <b>14-03</b>
(21) Taotluse number	D200500007	
(15) Registreerimise päev	15.08.2005	
(22) Esitamise päev	15.02.2005	
(24) Registreeringu kehtivuse alguse päev	15.02.2005	
(18) Registreeringu kehtivuse lõppemise päev	15.02.2010	
(28) Variantide arv	1	
(30) Prioriteediandmed	29/211,455, 17.08.2004, US	
(72) Autor	Shunjiro Eguchi, Otavantie 3 A 25, FI Helsinki, FI	
(73) Omanik	Nokia Corporation, Keilalahdentie 4, FIN-02150 Espoo, FI	
(74) Patendivolinik või ühine esindaja	Kaie Puur	

(54) Nimetus **Käsitlefoni esipaneel / esiosa**

(55) Reproduktsoon

01096-01

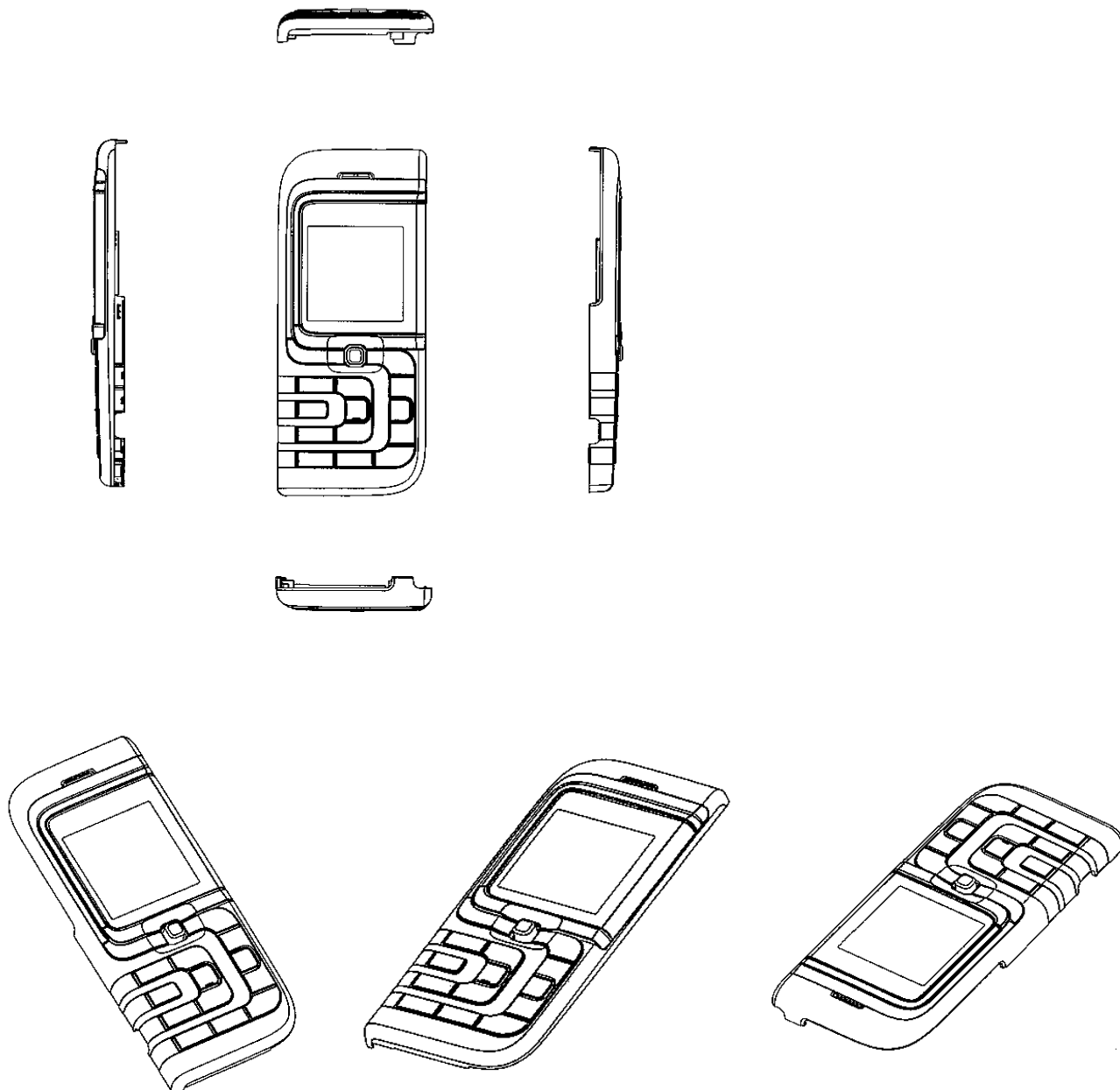

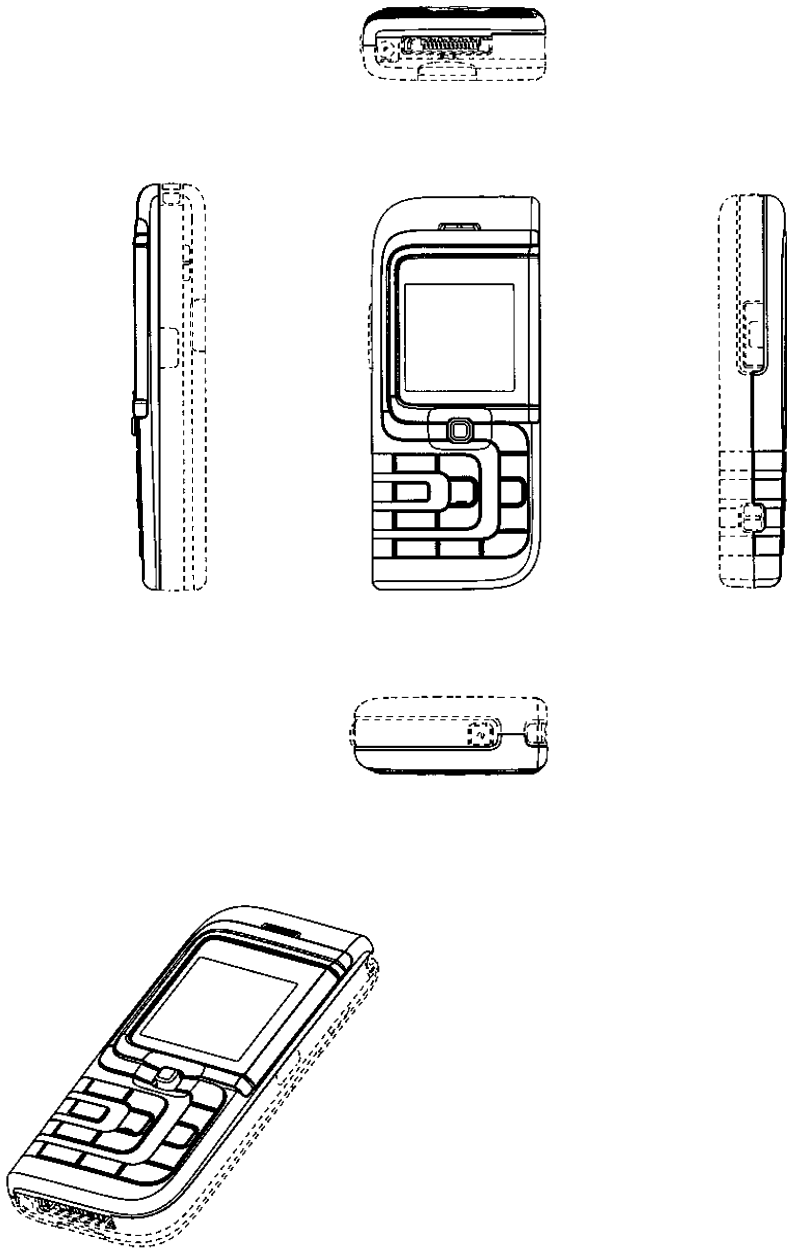

(11) Registreeringu number **01097**

(51) Klass: 14-03

(21) Taotluse number D200500008

(15) Registreerimise päev 15.08.2005

(22) Esitamise päev 15.02.2005

(24) Registreeringu kehtivuse alguse päev 15.02.2005

(18) Registreeringu kehtivuse lõppemise päev 15.02.2010

(28) Variantide arv 1

(30) Prioriteediandmed 29/211,455, 17.08.2004, US

(72) Autor Shunjiro Eguchi, Otavantie 3 A 25, FI Helsinki, FI

(73) Omanik Nokia Corporation, Keilalahdentie 4, FIN-02150 Espoo, FI

(74) Patendivolinik või ühine esindaja Kaie Puur

(54) Nimetus **Käsitelefoni tagapaneel / tagaosa**

(55) Reproduktsoon

01097-01

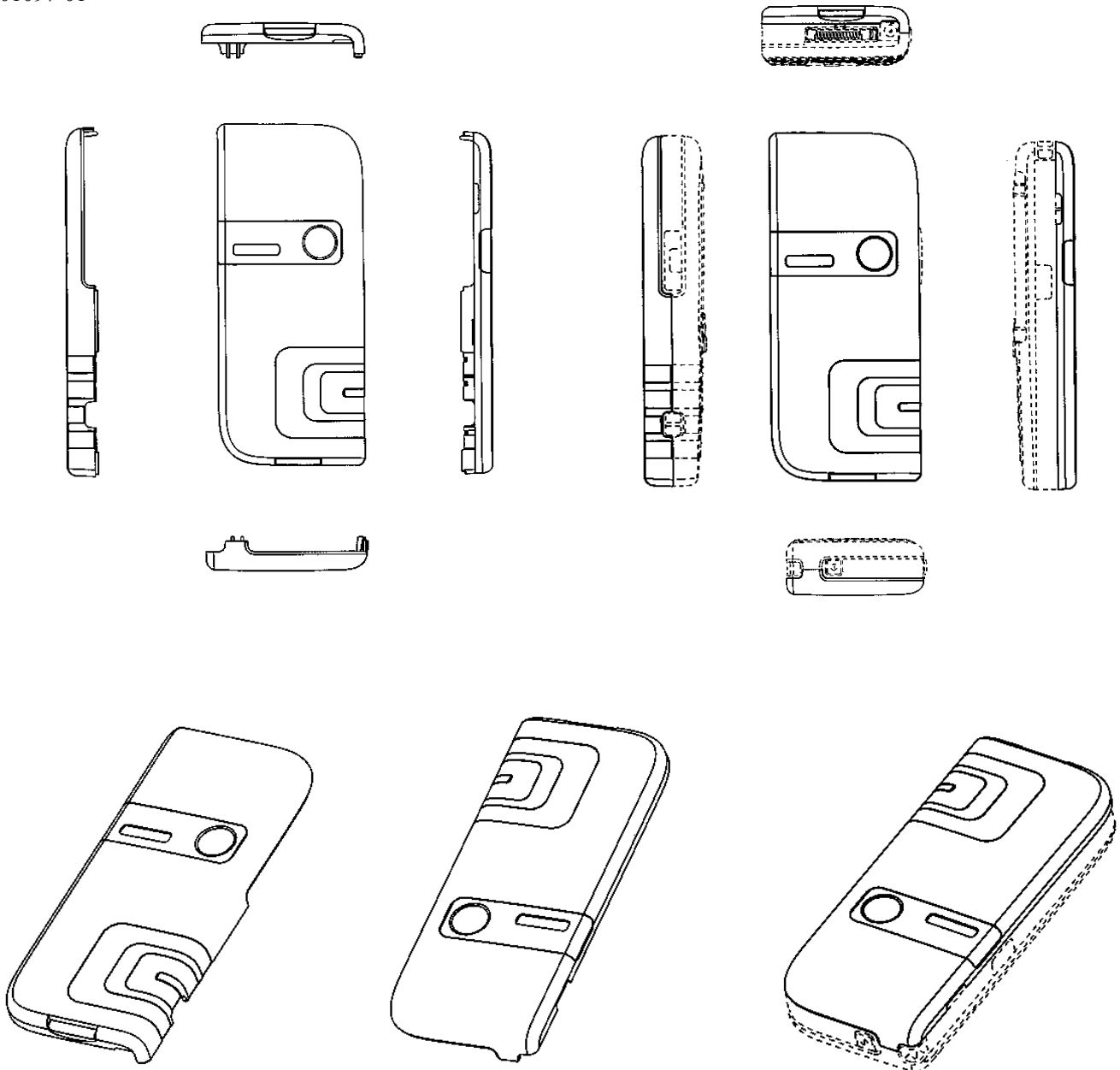

(11) Registreeringu number	<b>01098</b>	(51) Klass: <b>14-03</b>
(21) Taotluse number	D200500009	
(15) Registreerimise päev	15.08.2005	
(22) Esitamise päev	15.02.2005	
(24) Registreeringu kehtivuse alguse päev	15.02.2005	
(18) Registreeringu kehtivuse lõppemise päev	15.02.2010	
(28) Variantide arv	1	
(30) Prioriteediandmed	29/211,455, 17.08.2004, US	
(72) Autor	Shunjiro Eguchi, Otavantie 3 A 25, FI Helsinki, FI	
(73) Omanik	Nokia Corporation, Keilalahdentie 4, FIN-02150 Espoo, FI	
(74) Patendivolinik või ühine esindaja	Kaie Puur	

(54) Nimetus **Käsitelefoni klaviatuur / klaviatuuriklahvide paigutus**

(55) Reproduktsoon

01098-01

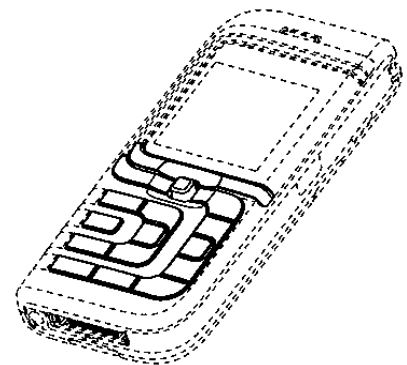
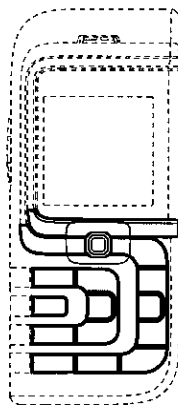
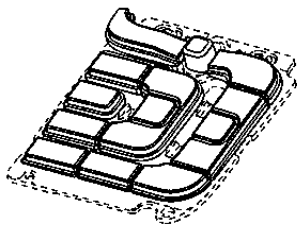
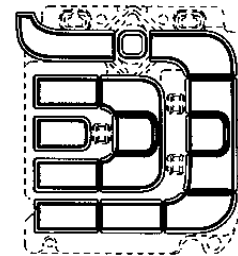
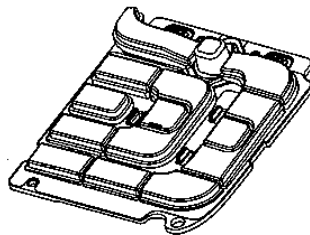
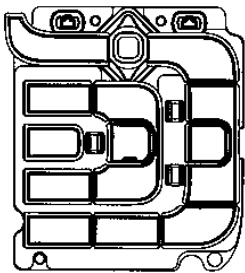

(11) Registreeringu number	<b>01099</b>	(51) Klass: <b>14-03</b>
(21) Taotluse number	D200500016	
(15) Registreerimise päev	15.08.2005	
(22) Esitamise päev	15.03.2005	
(24) Registreeringu kehtivuse alguse päev	15.03.2005	
(18) Registreeringu kehtivuse lõppemise päev	15.03.2010	
(28) Variantide arv	1	
(30) Prioriteediandmed	M20040148, 16.09.2004, FI	
(72) Autor	Shiho Nakajima, 4-2-13-701 Todoroki, Setagaya-ku, 158-0082 Tokyo, JP	
(73) Omanik	Nokia Corporation, Keilalahdentie 4, FIN-02150 Espoo, FI	
(74) Patendivolinik või ühine esindaja	Kalev Käosaar	

(54) Nimetus **Käsitelefon**

(55) Reproduktsoon

01099-01

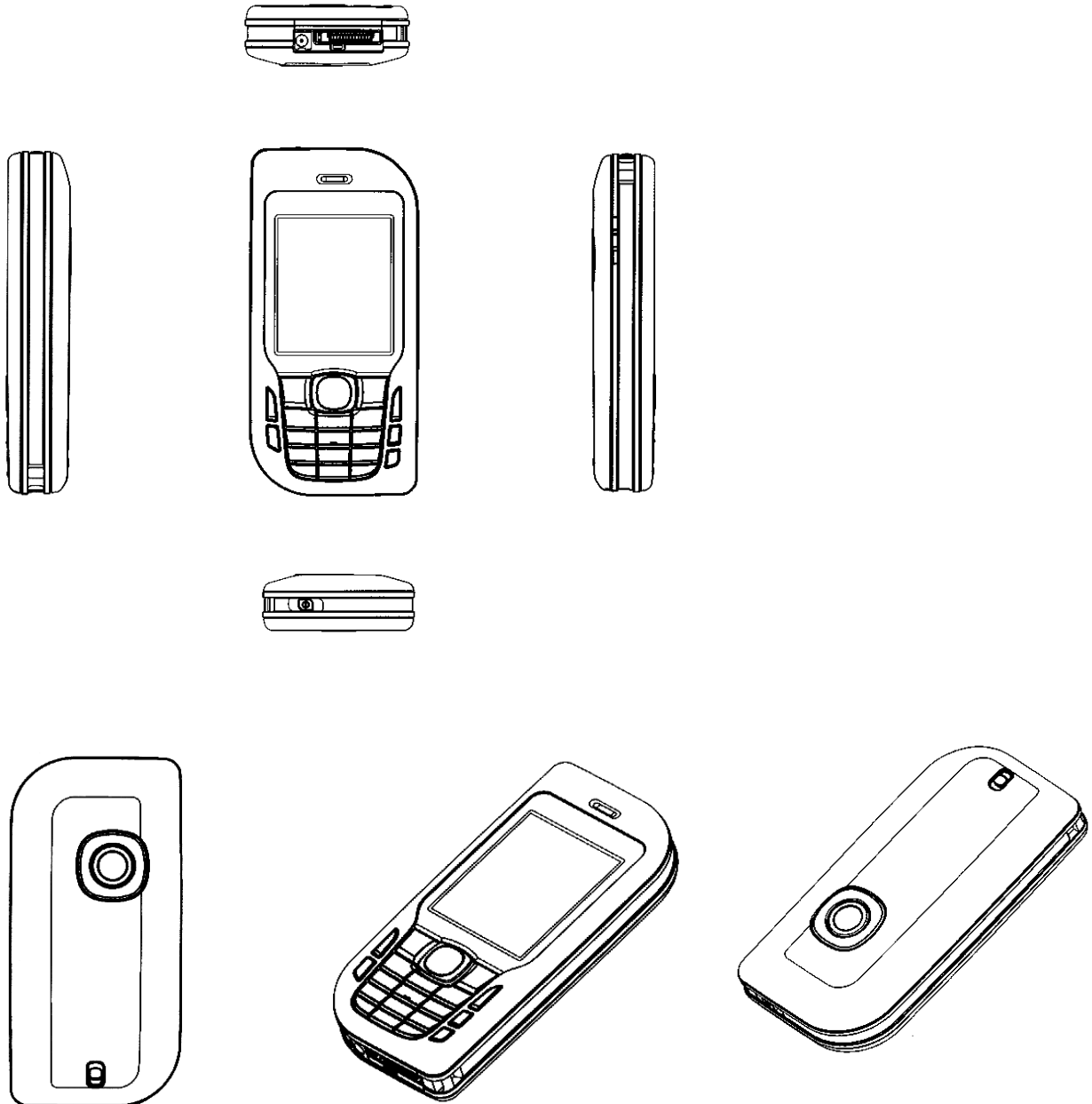

(11) **Registreeringu number** **01100**

(51) Klass: **14-03**

(21) **Taotluse number** D200500041

(15) **Registreerimise päev** 15.08.2005

(22) **Esitamise päev** 27.04.2005

(24) **Registreeringu kehtivuse alguse päev** 27.04.2005

(18) **Registreeringu kehtivuse lõppemise päev** 27.04.2010

(28) **Variantide arv** 1

(30) **Prioriteediandmed** M20040171, 29.10.2004, FI

(72) **Autor** Anton Fahlgren, Näsilinnankatu 24 D 23, 33210 Tampere, FI

(73) **Omanik** Nokia Corporation, Keilalahdentie 4, FIN-02150 Espoo, FI

(74) **Patendivolinik või ühine esindaja** Kalev Käosaar

(54) **Nimetus** **Käsitelefon**

(55) **Reproduktsoon**

01100-01

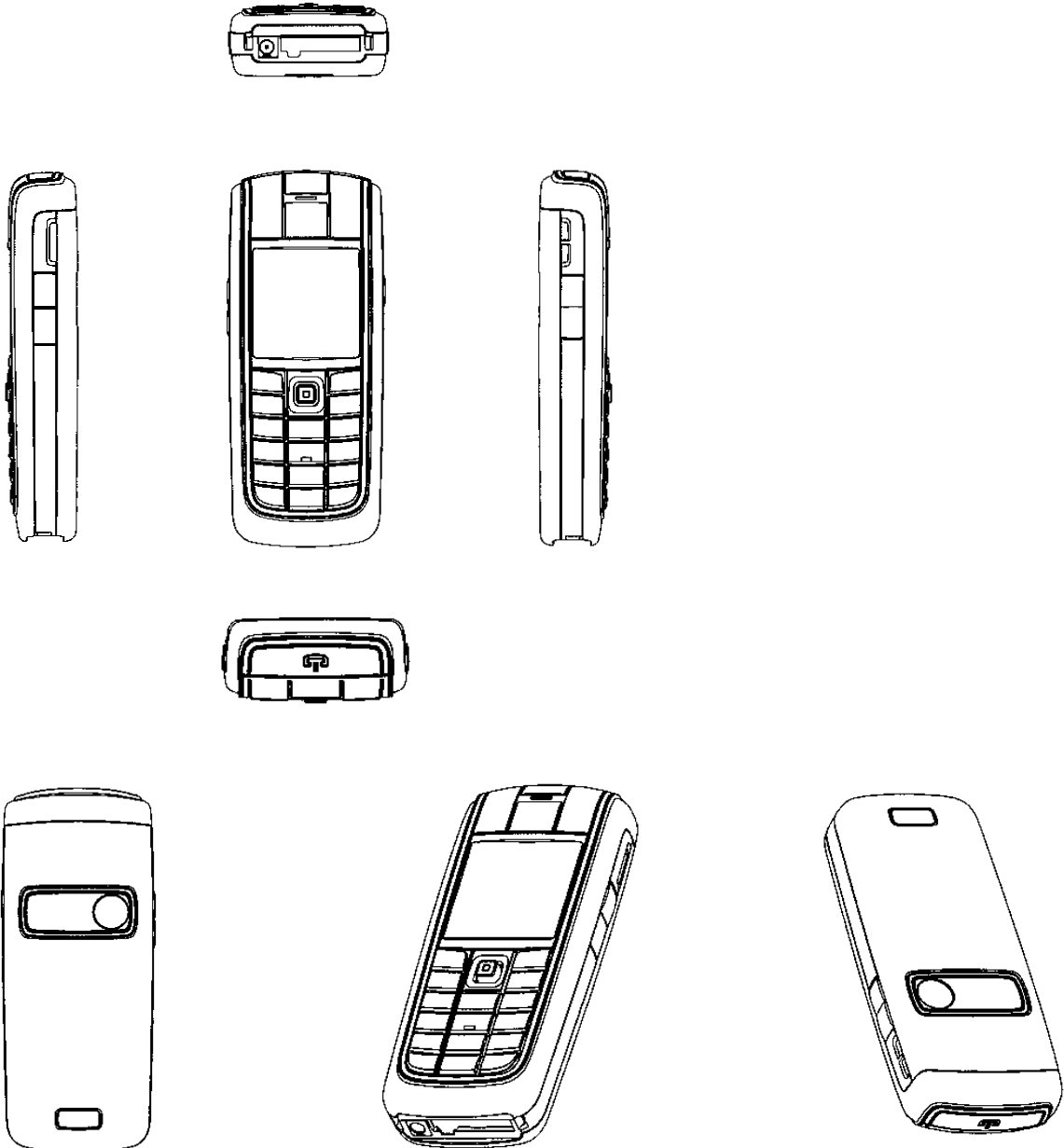



(11) Registreeringu number	01101	(51) Klass: 14-01, 14-02, 14-03
(21) Taotluse number	D200500045	
(15) Registreerimise päev	15.08.2005	
(22) Esitamise päev	28.04.2005	
(24) Registreeringu kehtivuse alguse päev	28.04.2005	
(18) Registreeringu kehtivuse lõppemise päev	28.04.2010	
(28) Variantide arv	1	
(30) Prioriteediandmed	M20040171, 29.10.2004, FI	
(72) Autor	Pertti Salmi, Sirppitie 30, 90530 Oulu, FI	
(73) Omanik	Nokia Corporation, Keilalahdentie 4, FIN-02150 Espoo, FI	
(74) Patendivolinik või ühine esindaja	Kalev Käosaar	

(54) Nimetus Meediaseadme / mobiiltelefoni tagapaneel

(55) Reproduktsoon

01101-01

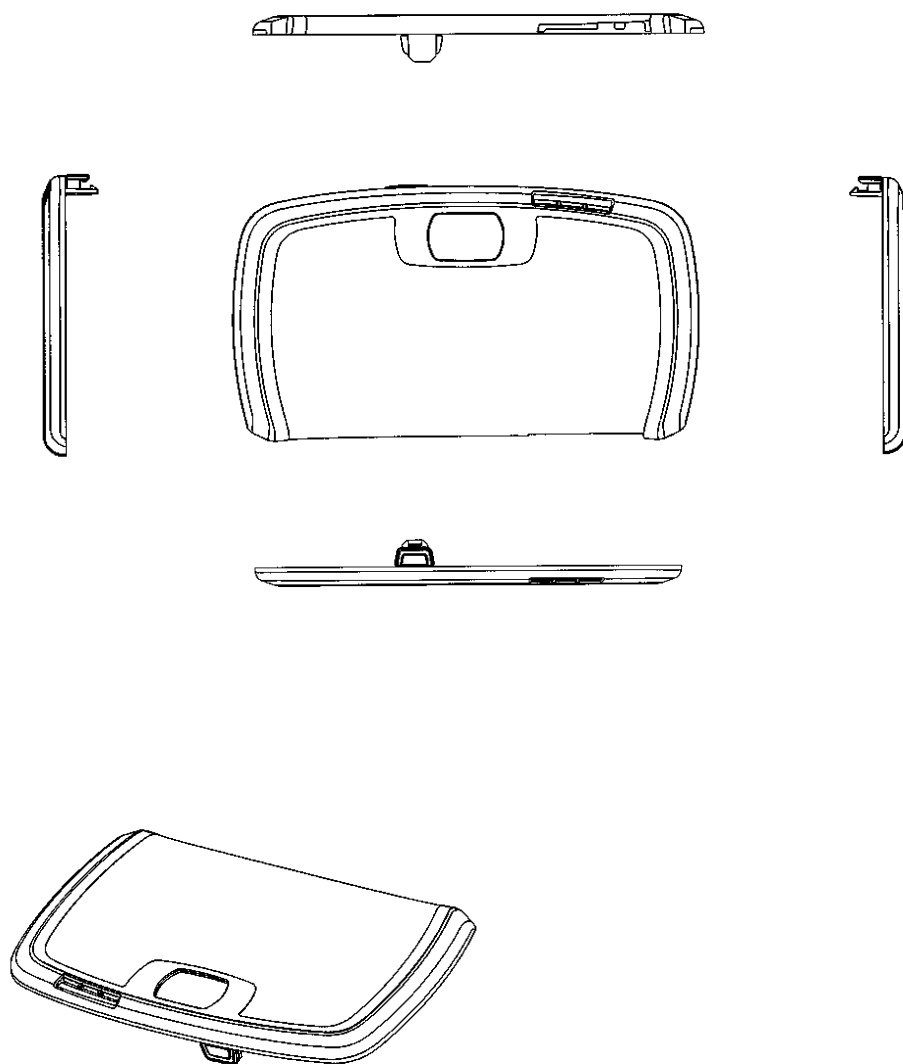

- (11) **Registreeringu number** **01102**
- (21) **Taotluse number** D200500046
- (15) **Registreerimise päev** 15.08.2005
- (22) **Esitamise päev** 28.04.2005
- (24) **Registreeringu kehtivuse alguse päev** 28.04.2005
- (18) **Registreeringu kehtivuse lõppemise päev** 28.04.2010
- (28) **Variantide arv** 1
- (30) **Prioriteediandmed** M20040171, 29.10.2004, FI
- (72) **Autor** Pertti Salmi, Sirppitie 30, 90530 Oulu, FI
- (73) **Omanik** Nokia Corporation, Keilalahdentie 4, FIN-02150 Espoo, FI
- (74) **Patendivolinik või ühine esindaja** Kalev Käosaar

(51) Klass: 14-01, 14-02, 14-03

(54) **Nimetus** **Meediaseadme / mobiiltelefoni esipaneel**

(55) **Reproduktsoon**

01102-01

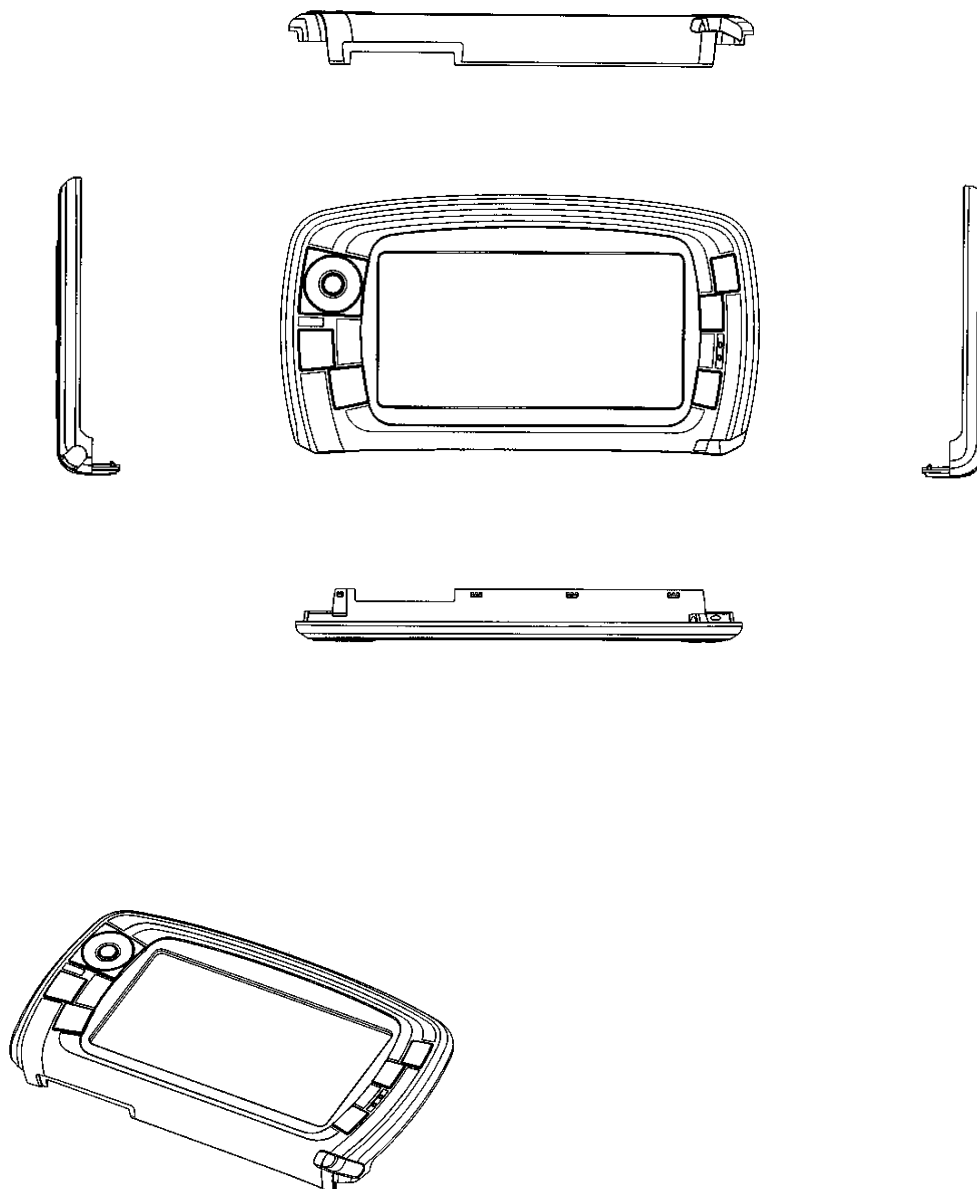

(11) Registreeringu number	<b>01103</b>	(51) Klass: 14-01, 14-02, 14-03
(21) Taotluse number	D200500047	
(15) Registreerimise päev	15.08.2005	
(22) Esitamise päev	28.04.2005	
(24) Registreeringu kehtivuse alguse päev	28.04.2005	
(18) Registreeringu kehtivuse lõppemise päev	28.04.2010	
(28) Variantide arv	1	
(30) Prioriteediandmed	M20040171, 29.10.2004, FI	
(72) Autor	Pertti Salmi, Sirppitie 30, 90530 Oulu, FI	
(73) Omanik	Nokia Corporation, Keilalahdentie 4, FIN-02150 Espoo, FI	
(74) Patendivolinik või ühine esindaja	Kalev Käosaar	

(54) Nimetus **Meediaseade / mobiiltelefon**

(55) Reproduktsoon

01103-01

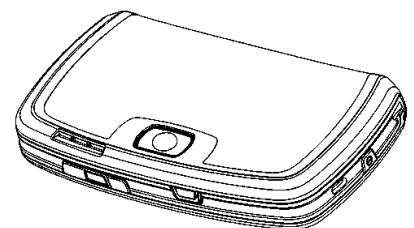
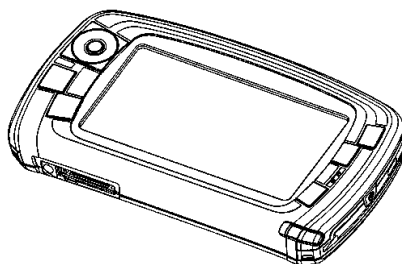
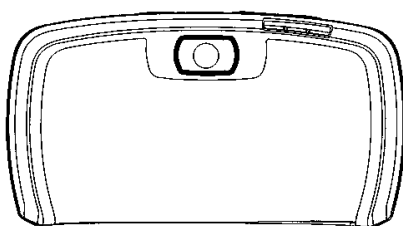
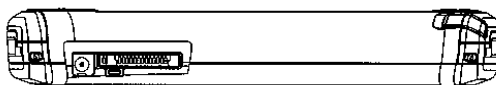
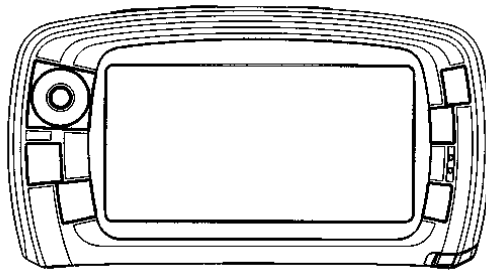

(11) **Registreeringu number** **01104**

(51) Klass: **14-03**

(21) **Taotluse number** D200500048

(15) **Registreerimise päev** 15.08.2005

(22) **Esitamise päev** 04.05.2005

(24) **Registreeringu kehtivuse alguse päev** 04.05.2005

(18) **Registreeringu kehtivuse lõppemise päev** 04.05.2010

(28) **Variantide arv** 1

(30) **Prioriteediandmed** M20040173, 04.11.2004, FI

(72) **Autor** Anton Fahlgren, Näsilinnankatu 24 D 23, 33210 Tampere, FI

(73) **Omanik** Nokia Corporation, Keilalahdentie 4, FIN-02150 Espoo, FI

(74) **Patendivolinik või ühine esindaja** Kaie Puur

(54) **Nimetus** **Käsitelefon**

(55) **Reproduktsoon**

01104-01

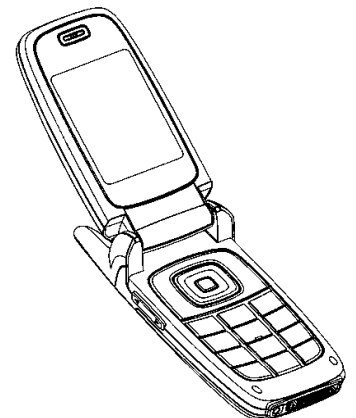
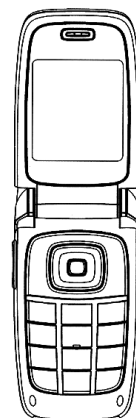
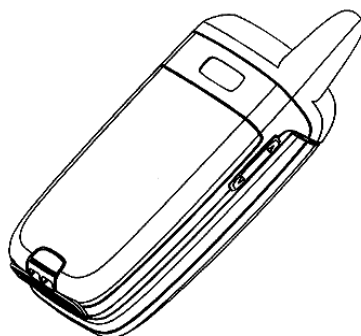
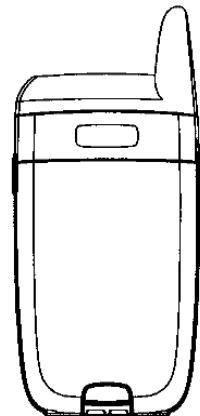
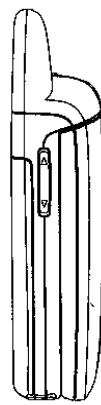
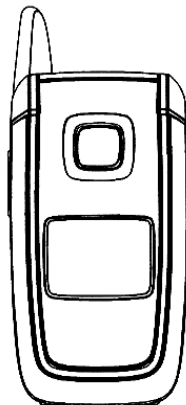
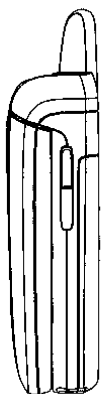
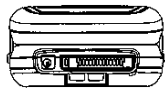

(11) **Registreeringu number** **01105**

(51) Klass: **14-03**

(21) **Taotluse number** D200500049

(15) **Registreerimise päev** 15.08.2005

(22) **Esitamise päev** 04.05.2005

(24) **Registreeringu kehtivuse alguse päev** 04.05.2005

(18) **Registreeringu kehtivuse lõppemise päev** 04.05.2010

(28) **Variantide arv** 1

(30) **Prioriteediandmed** M20040173, 04.11.2004, FI

(72) **Autor** Anton Fahlgren, Näsilinnankatu 24 D 23, 33210 Tampere, FI

(73) **Omanik** Nokia Corporation, Keilalahdentie 4, FIN-02150 Espoo, FI

(74) **Patendivolinik või ühine esindaja** Kaie Puur

(54) **Nimetus** **Käsitelefon**

(55) **Reproduktsoon**

01105-01

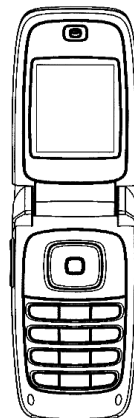
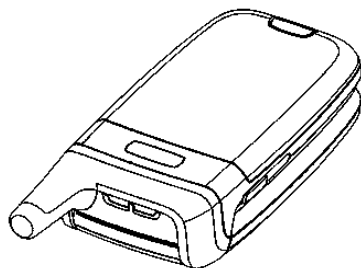
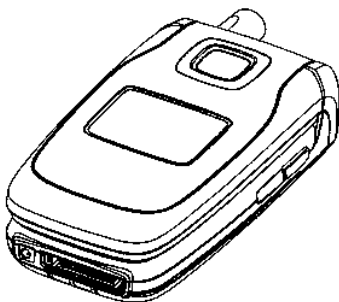
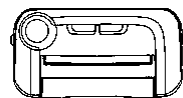
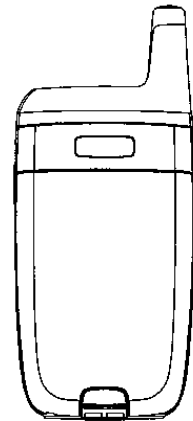
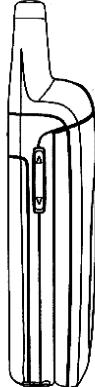
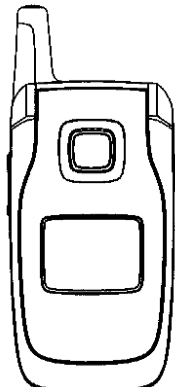
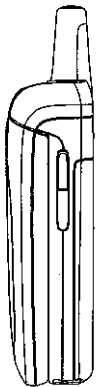
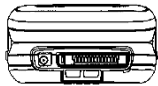

(11) Registreeringu number	<b>01106</b>	(51) Klass: <b>28-01</b>
(21) Taotluse number	D200400033	
(15) Registreerimise päev	15.08.2005	
(22) Esitamise päev	15.03.2004	
(24) Registreeringu kehtivuse alguse päev	15.03.2004	
(18) Registreeringu kehtivuse lõppemise päev	15.03.2009	
(28) Variantide arv	4	
(30) Prioriteediandmed	000076682, 16.09.2003, EM	
(72) Autor	Jean-Daniel Bonny, Grundackerstrasse 20d, 4414 Füllinsdorf, CH Stefan Hirsch, Theodor-Heuss-Strasse 21A, 79539 Lörrach, DE Oskar Kalb, Belchenstrasse 9, 79539 Lörrach, DE Peter Pietzonka, Zeinigerstrasse 4, 4464 Maisprach, CH	
(73) Omanik	Novartis AG, Lichtstrasse 35, 4056 Basel, CH	
(74) Patendivolinik või ühine esindaja	Kaie Puur	

(54) Nimetus **Kapsel**

(55) Reproduktsoon

01106-01

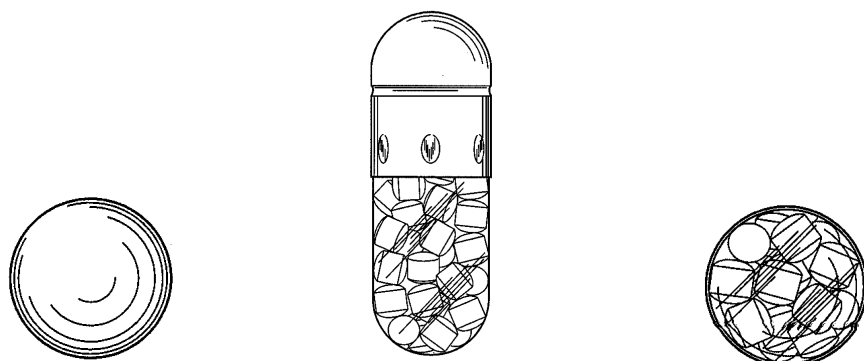

01106-02



01106-03

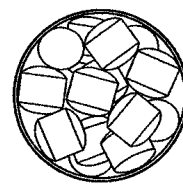
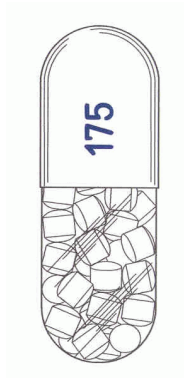
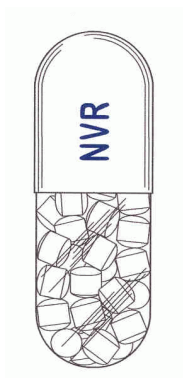
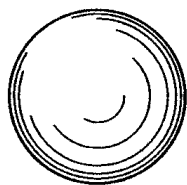

01106-04

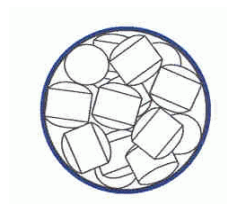
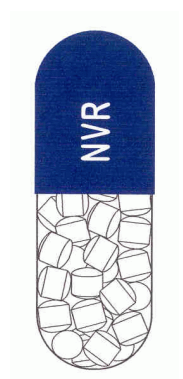
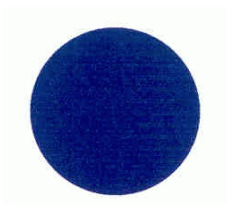

- (11) **Registreeringu number** **01107** (51) Klass: **28-01**
- (21) **Taotluse number** D200400033A
- (15) **Registreerimise päev** 15.08.2005
- (22) **Esitamise päev** 15.03.2004
- (24) **Registreeringu kehtivuse alguse päev** 15.03.2004
- (18) **Registreeringu kehtivuse lõppemise päev** 15.03.2009
- (28) **Variantide arv** 1
- (30) **Prioriteediandmed** 000076682, 16.09.2003, EM
- (72) **Autor** Jean-Daniel Bonny, Grundackerstrasse 20d, 4414 Füllinsdorf, CH  
Stefan Hirsch, Theodor-Heuss-Strasse 21A, 79539 Lörrach, DE  
Oskar Kalb, Belchenstrasse 9, 79539 Lörrach, DE  
Peter Pietzonka, Zeinigerstrasse 4, 4464 Maisprach, CH
- (73) **Omanik** Novartis AG, Lichtstrasse 35, 4056 Basel, CH
- (74) **Patendivolinik või ühine esindaja** Kaie Puur
- (54) **Nimetus** **Tablett**
- (55) **Reproduksioon**

01107-01

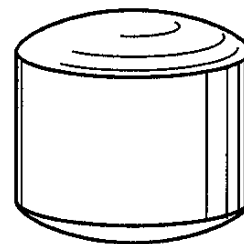
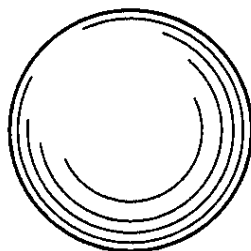
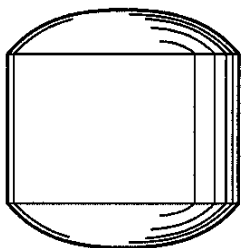



(11) Registreeringu number	<b>01108</b>	(51) Klass: <b>14-03</b>
(21) Taotluse number	D200500040	
(15) Registreerimise päev	15.08.2005	
(22) Esitamise päev	26.04.2005	
(24) Registreeringu kehtivuse alguse päev	26.04.2005	
(18) Registreeringu kehtivuse lõppemise päev	26.04.2010	
(28) Variantide arv	1	
(30) Prioriteediandmed	29/216,098, 28.10.2004, US	
(72) Autor	Duncan Burns, #203 18645 Hatteras St., Tarzana, CA 91356, US	
(73) Omanik	Nokia Corporation, Keilalahdentie 4, FIN-02150 Espoo, FI	
(74) Patendivolinik või ühine esindaja	Kalev Käosaar	

(54) Nimetus **Käsitelefon**

(55) Reproduktsoon

01108-01

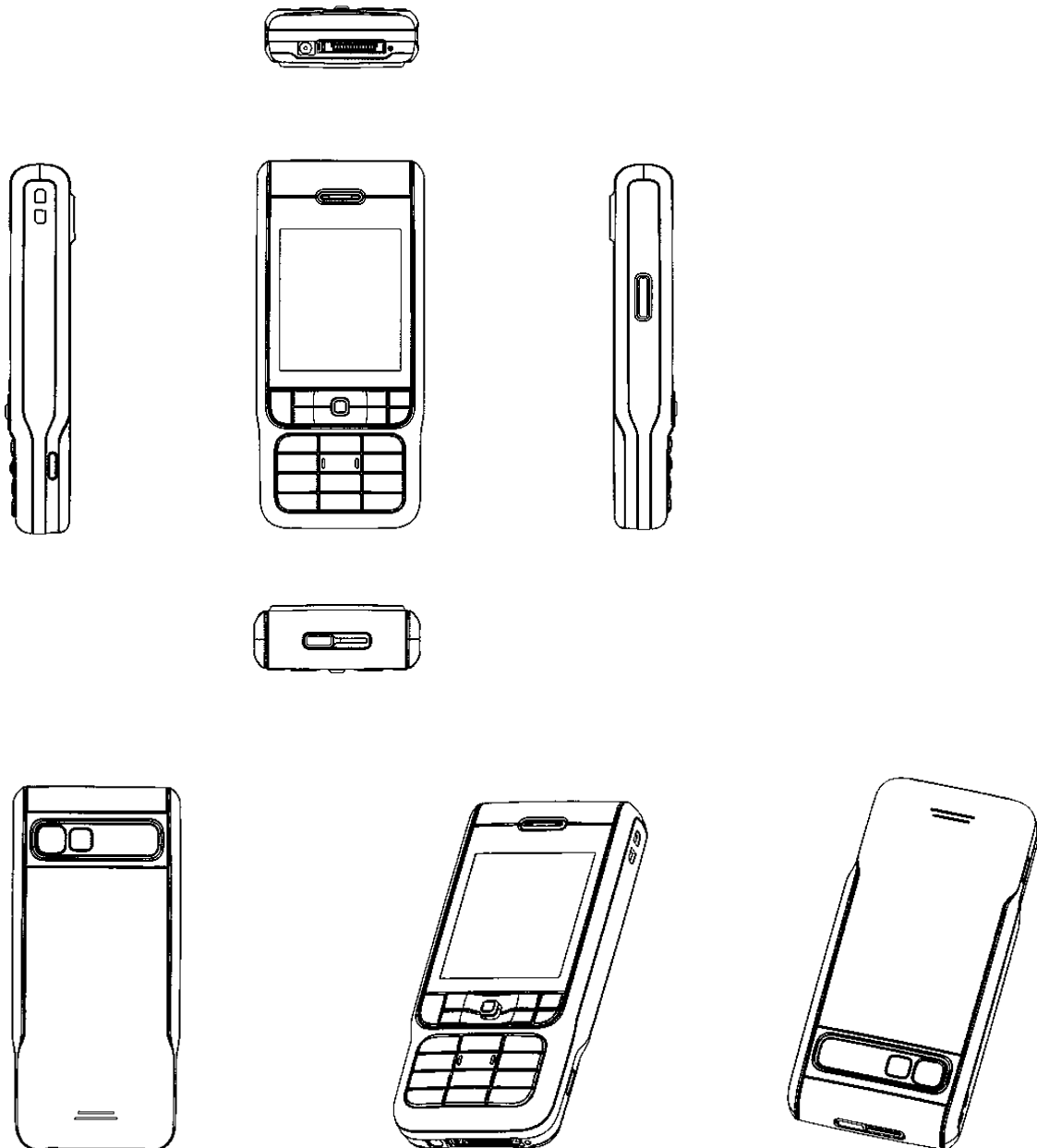

(11) Registreeringu number	<b>01109</b>	(51) Klass: <b>14-03</b>
(21) Taotluse number	D200500051	
(15) Registreerimise päev	15.08.2005	
(22) Esitamise päev	13.05.2005	
(24) Registreeringu kehtivuse alguse päev	13.05.2005	
(18) Registreeringu kehtivuse lõppemise päev	13.05.2010	
(28) Variantide arv	1	
(30) Prioriteediandmed	M20040193, 19.11.2004, FI	
(72) Autor	Matti Juhani (Jussi) Ruuhonen, Piispankatu 6 D 40-41, FIN-20500 Turku, FI	
(73) Omanik	Nokia Corporation, Keilalahdentie 4, FIN-02150 Espoo, FI	
(74) Patendivolinik või ühine esindaja	Kalev Käosaar	

(54) Nimetus **Käsitelefon**

(55) Reproduktsoon

01109-01

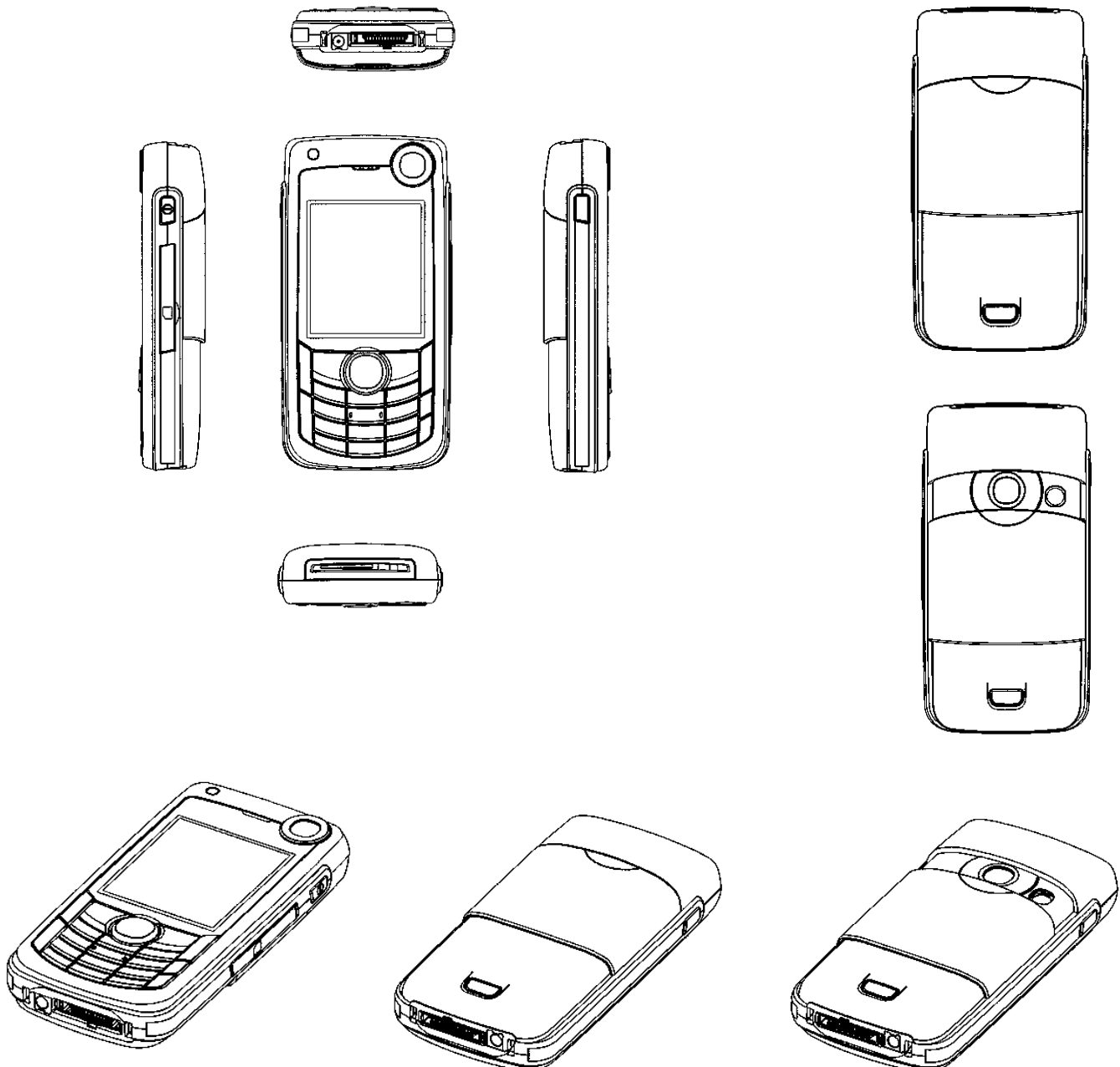

(11) Registreeringu number	01110	(51) Klass: 14-03
(21) Taotluse number	D200500042	
(15) Registreerimise päev	15.08.2005	
(22) Esitamise päev	27.04.2005	
(24) Registreeringu kehtivuse alguse päev	27.04.2005	
(18) Registreeringu kehtivuse lõppemise päev	27.04.2010	
(28) Variantide arv	1	
(30) Prioriteediandmed	M20040171, 29.10.2004, FI	
(72) Autor	Anton Fahlgren, Näsilinnankatu 24 D 23, 33210 Tampere, FI	
(73) Omanik	Nokia Corporation, Keilalahdentie 4, FIN-02150 Espoo, FI	
(74) Patendivolinik või ühine esindaja	Kalev Käosaar	

(54) Nimetus **Käsitelefoni klaviatuuri klahvide paigutus / klaviatuur**

(55) Reproduktsoon

01110-01

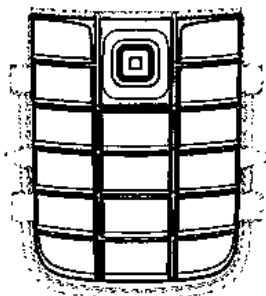
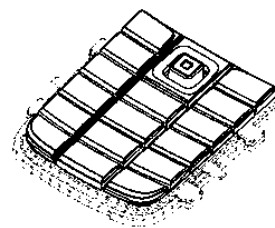
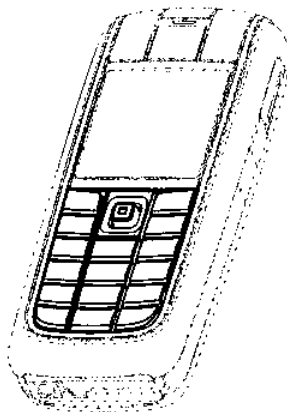
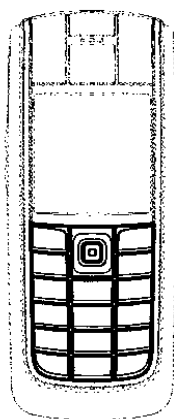

(11) Registreeringu number **01111**

(51) Klass: **14-03**

(21) Taotluse number D200500043

(15) Registreerimise päev 15.08.2005

(22) Esitamise päev 27.04.2005

(24) Registreeringu kehtivuse alguse päev 27.04.2005

(18) Registreeringu kehtivuse lõppemise päev 27.04.2010

(28) Variantide arv 1

(30) Prioriteediandmed M20040171, 29.10.2004, FI

(72) Autor Anton Fahlgren, Näsilinnankatu 24 D 23, 33210 Tampere, FI

(73) Omanik Nokia Corporation, Keilalahdentie 4, FIN-02150 Espoo, FI

(74) Patendivolinik või ühine esindaja Kalev Käosaar

(54) Nimetus **Käsitelefoni esipaneel / esiosa**

(55) Reproduktsoon

01111-01

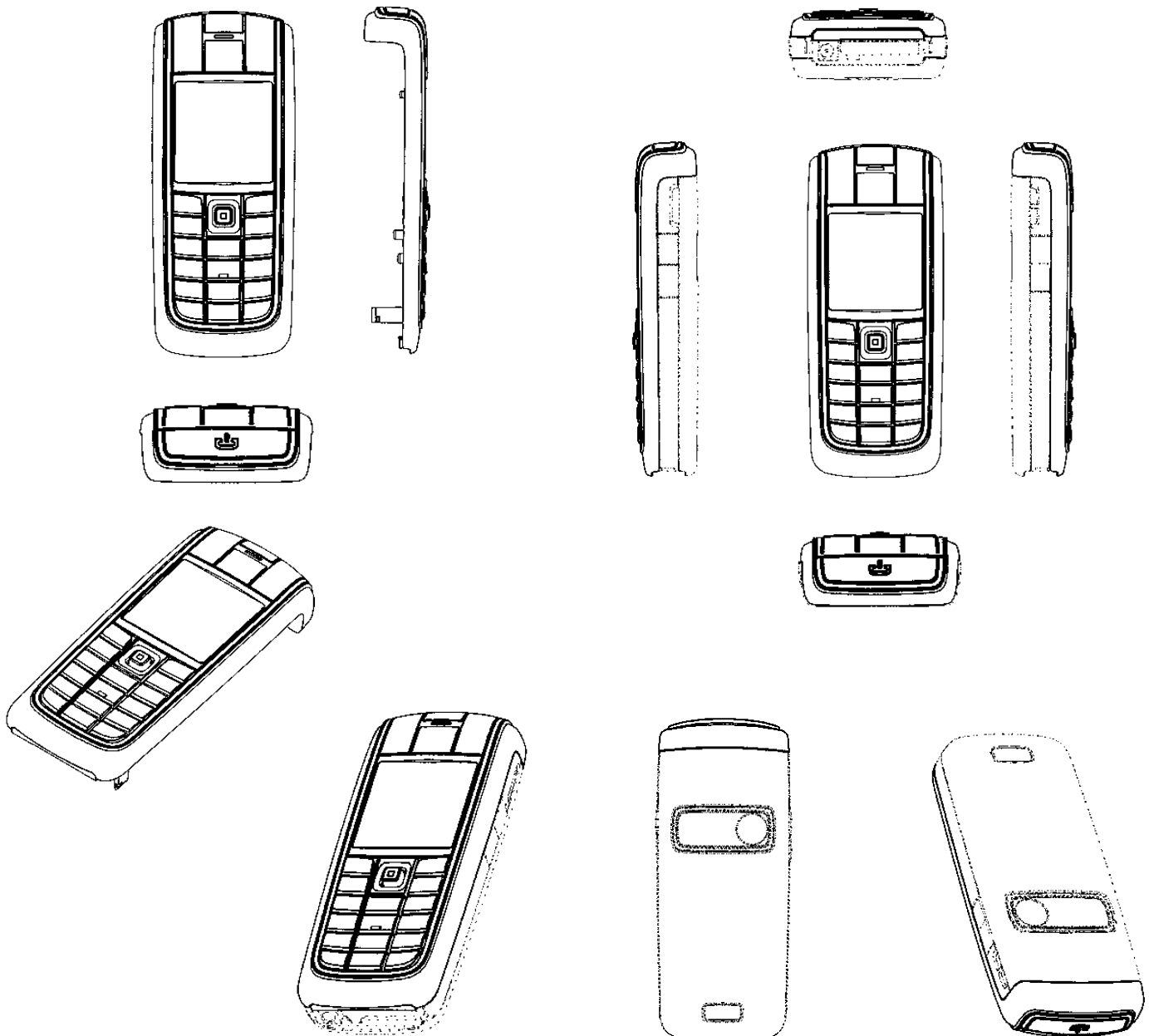

- (11) **Registreeringu number** **01112** (51) Klass: **11-02**
- (21) **Taotluse number** D200500044
- (15) **Registreerimise päev** 15.08.2005
- (22) **Esitamise päev** 28.04.2005
- (24) **Registreeringu kehtivuse alguse päev** 28.04.2005
- (18) **Registreeringu kehtivuse lõppemise päev** 28.04.2010
- (28) **Variantide arv** 2
- (72) **Autor** Hannu Juhani Karlsson, Hietaniityntie 2C 14, 00730 Helsinki, FI
- (73) **Omanik** Küllike Eller, Vilde tee 52-140, 13421 Tallinn, EE
- (54) **Nimetus** **Klaasist dekoratiivese**
- (55) **Reproduktsoon**

01112-01



01112-02



- (11) **Registreeringu number** **01113** (51) Klass: **19-08, 09-99**
- (21) **Taotluse number** D200500052
- (15) **Registreerimise päev** 15.08.2005
- (22) **Esitamise päev** 27.05.2005
- (24) **Registreeringu kehtivuse alguse päev** 27.05.2005
- (18) **Registreeringu kehtivuse lõppemise päev** 27.05.2010
- (28) **Variantide arv** 6
- (72) **Autor** Zara Huddleston, Ul. Pilicka 5, 02-629 Warszawa, PL
- (73) **Omanik** COMPAGNIE GERVAIS DANONE, 126-130, rue Jules Guesde, 92300 Levallois-Perret, FR
- (74) **Patendivolinik või ühine esindaja** Riina Pärn
- (54) **Nimetus** **Danviva pakendi pinnalaotus kujundusmotiividega**
- (55) **Reproduktsoon värviline**

01113-01

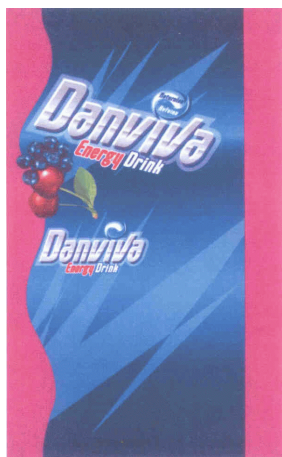

01113-02

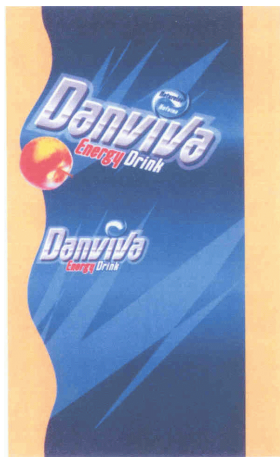

01113-03

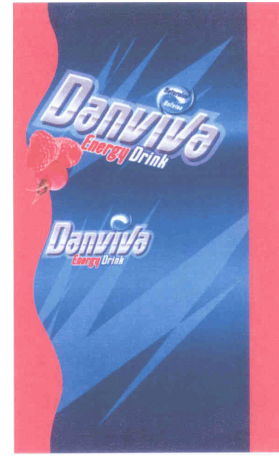

01113-04



01113-05

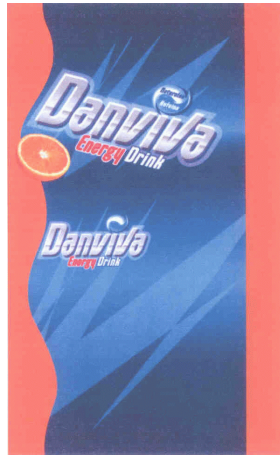

01113-06

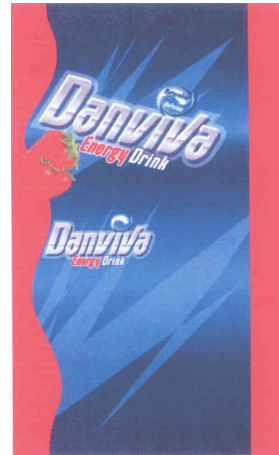

## **II. RAHVUSVAHELISELT REGISTREERITUD TÖÖSTUSDISAINILAHENDUSED**

Avaldatakse "Tööstusdisaini kaitse seaduse" § 87<sup>4</sup> lõike37 alusel.

(11) **Rahvusvah reg nr****DM/065469**(51) Klass: **14-03**(21) **Rahvusvah reg jrk**

H200400098

(15) **Registreeringu päev**

17.06.2004

(22) **Esitamise päev**

17.06.2004

(28) **Variantide arv**

1

(72) **Autor**

Silvano BONADEI, CDNP, Schützengasse 30, CH-2540 Grenchen, CH

(73) **Omanik**

SWATCH AG (SWATCH SA) (SWATCH LTD.), 94, Rue Jakob Stämpfli, CH-2502 BIENNE, CH

**WIPO Rahvusvah Tööstusdisainilahenduste****Bülletääni nr, kus registreering on avaldatud** 2004/11(54) **Nimetus****Communications device**(55) **Reproduktsoon**

DM/065469-01

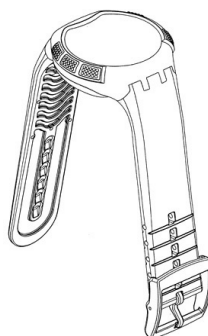
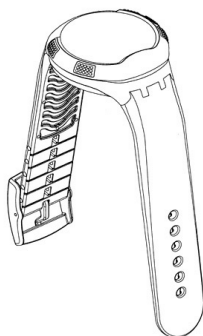
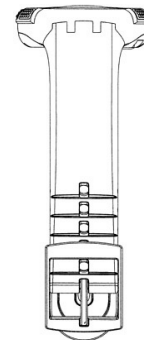
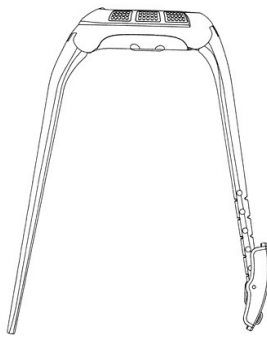
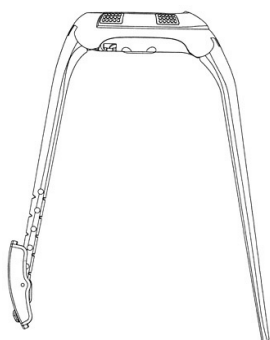
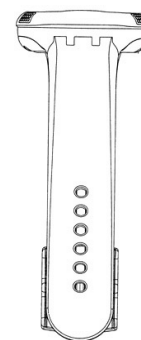
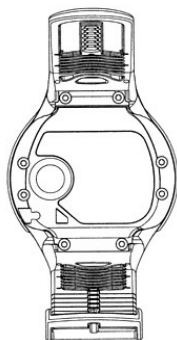



(11) <b>Rahvusvah reg nr</b>	<b>DM/065839</b>	(51) Klass: <b>10-02</b>
(21) <b>Rahvusvah reg jrk</b>	H200400089	
(15) <b>Registreeringu päev</b>	15.09.2004	
(22) <b>Esitamise päev</b>	15.09.2004	
(28) <b>Variantide arv</b>	1	
(72) <b>Autor</b>	Nicolas-Barth Nusbbaumer, Rue St-Honoré 10, CH-2000 NEUCHATEL, CH	
(73) <b>Omanik</b>	THE SWATCH GROUP MANAGEMENT SERVICES AG (THE SWATCH GROUP MANAGEMENT SERVICES SA), (THE SWATCH GROUP MANAGEMENT SERVICES LTD.), Seevorstadt 6, CH-2502 BIENNE, CH	

**WIPO Rahvusvah Tööstusdisainilahenduste  
Bülletääni nr, kus registreering on avaldatud** 2004/09

(54) **Nimetus** **Wristwatches**

(55) **Reproduksioon**

DM/065839-01

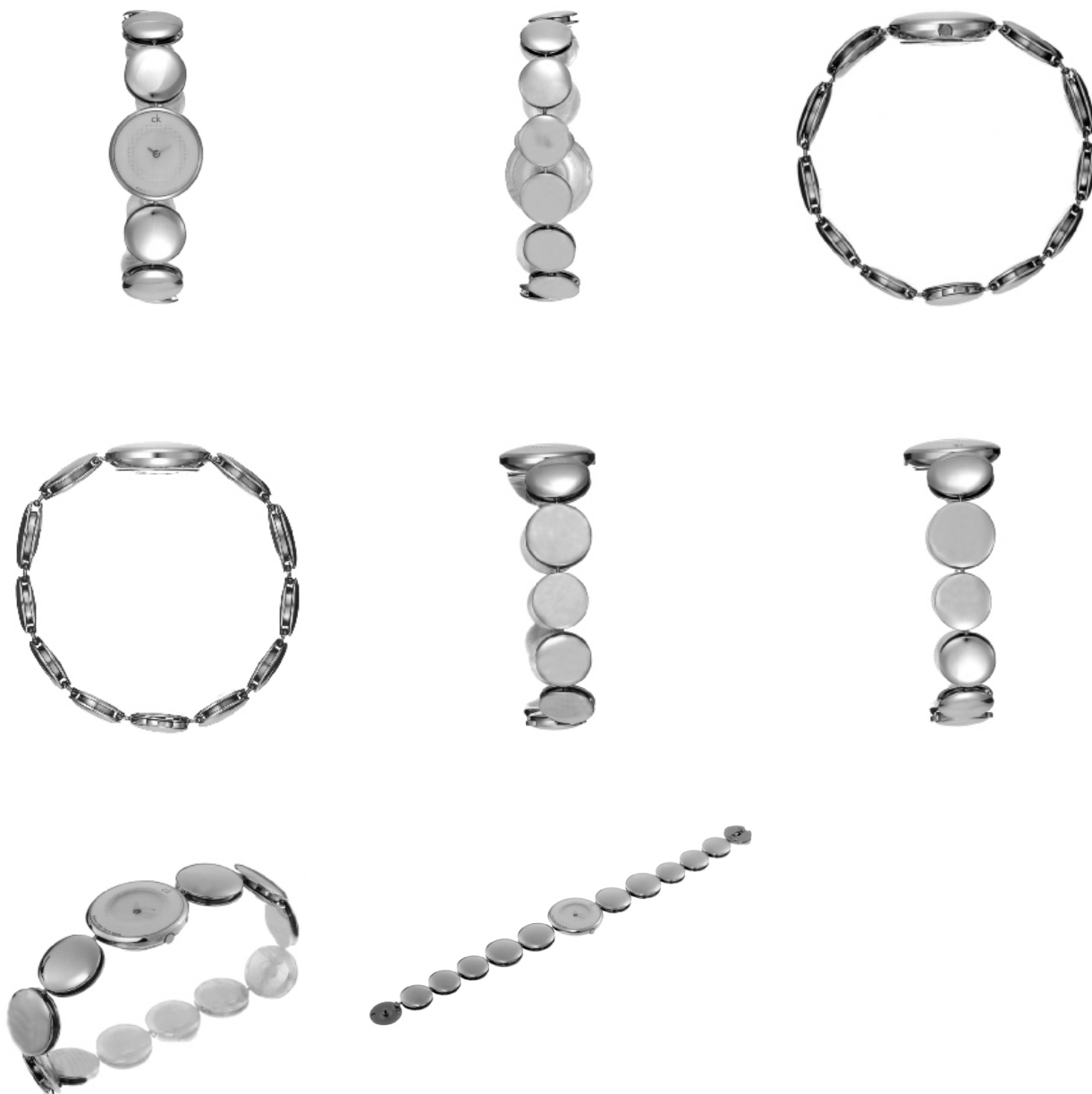

(11) <b>Rahvusvah reg nr</b>	<b>DM/065839</b>	(51) Klass: <b>10-02</b>
(21) <b>Rahvusvah reg jrk</b>	H200400089A	
(15) <b>Registreeringu päev</b>	15.09.2004	
(22) <b>Esitamise päev</b>	15.09.2004	
(28) <b>Variantide arv</b>	1	
(72) <b>Autor</b>	Nicolas Barth Nussbaumer, Rue St. Honoré 10, CH-2000 Neuchâtel, CH	
(73) <b>Omanik</b>	THE SWATCH GROUP MANAGEMENT SERVICES AG (THE SWATCH GROUP MANAGEMENT SERVICES SA), (THE SWATCH GROUP MANAGEMENT SERVICES LTD.), Seevorstadt 6, CH-2502 BIENNE, CH	

**WIPO Rahvusvah Tööstusdisainilahenduste  
Bülletääni nr, kus registreering on avaldatud** 2004/09

(54) **Nimetus** **Wristwatches**

(55) **Reproduksioon**

DM/065839-01

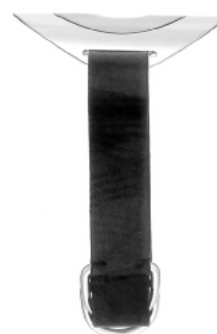

(11) **Rahvusvah reg nr****DM/065895**(51) Klass: **10-02**(21) **Rahvusvah reg jrk**

H200400092

(15) **Registreeringu päev**

10.09.2004

(22) **Esitamise päev**

10.09.2004

(28) **Variantide arv**

1

(30) **Prioriteediandmed**

155098, 01.04.2004, EM

(72) **Autor***Autori andmeid ei avalikustata*(73) **Omanik**SWAROVSKI AKTIENGESELLSCHAFT, 15, Dröschstrasse,  
P.O. Box 567, L-9495 Triesen, LI**WIPO Rahvusvah Tööstusdisainilahenduste****Bülletääni nr, kus registreering on avaldatud** 2004/10(54) **Nimetus****Wrist watch**(55) **Reproduktsoon**

DM/065895-01



(11) <b>Rahvusvah reg nr</b>	<b>DM/065941</b>	(51) <b>Klass: 10-02</b>
(21) <b>Rahvusvah reg jrk</b>	H200400093	
(15) <b>Registreeringu päev</b>	05.10.2004	
(22) <b>Esitamise päev</b>	05.10.2004	
(28) <b>Variantide arv</b>	1	
(72) <b>Autor</b>	Agnés Hertig, Saars 11, CH-2000 Neuchâtel, CH	
(73) <b>Omanik</b>	SWATCH AG (SWATCH SA) (SWATCH LTD.), 94, Rue Jakob Stämpfli, CH-2502 BIENNE, CH	
<b>WIPO Rahvusvah Tööstusdisainilahenduste Bülletääni nr, kus registreering on avaldatud</b>	2004/10	

(54) **Nimetus** **Wristwatch**

(55) **Reproduktsoon**

DM/065941-01



(11) <b>Rahvusvah reg nr</b>	<b>DM/065957</b>	(51) Klass: <b>10-02</b>
(21) <b>Rahvusvah reg jrk</b>	H200400095	
(15) <b>Registreeringu päev</b>	18.10.2004	
(22) <b>Esitamise päev</b>	18.10.2004	
(28) <b>Variantide arv</b>	1	
(72) <b>Autor</b>	Rossana BOFFI, Swatchlab, Via Archimede 6, 20129 Milano, IT	
(73) <b>Omanik</b>	SWATCH AG (SWATCH SA) (SWATCH LTD.), 94, Rue Jakob Stämpfli, CH-2502 BIENNE, CH	
<b>WIPO Rahvusvah Tööstusdisainilahenduste Bülletääni nr, kus registreering on avaldatud</b>	2004/10	

(54) **Nimetus** **Wristwatch**

(55) **Reproduktsoon**

DM/065957-01



(11) <b>Rahvusvah reg nr</b>	<b>DM/065958</b>	(51) Klass: <b>10-02</b>
(21) <b>Rahvusvah reg jrk</b>	H200400096	
(15) <b>Registreeringu päev</b>	18.10.2004	
(22) <b>Esitamise päev</b>	18.10.2004	
(28) <b>Variantide arv</b>	1	
(72) <b>Autor</b>	Walter GARRO, SWATCHLAB, Via Archimede 6, IT-20129 MILANO, IT	
(73) <b>Omanik</b>	SWATCH AG (SWATCH SA) (SWATCH LTD.), 94, Rue Jakob Stämpfli, CH-2502 BIENNE, CH	
<b>WIPO Rahvusvah Tööstusdisainilahenduste Bülletääni nr, kus registreering on avaldatud</b>	2004/10	

(54) **Nimetus** **Wristwatch**

(55) **Reproduksioon**

DM/065958-01



(11) **Rahvusvah reg nr****DM/066005**(51) Klass: **20-02**(21) **Rahvusvah reg jrk**

H200400099

(15) **Registreeringu päev**

04.11.2004

(22) **Esitamise päev**

04.11.2004

(28) **Variantide arv**

1

(72) **Autor**

Luca Tonella, SWATCH SA, 94, rue Jakob-Stämpfli, CH-2502 Bienne, CH

(73) **Omanik**

SWATCH AG (SWATCH SA) (SWATCH LTD.), 94, Rue Jakob Stämpfli, CH-2502 BIENNE, CH

**WIPO Rahvusvah Tööstusdisainilahenduste****Bülletääni nr, kus registreering on avaldatud** 2004/11(54) **Nimetus****Sales kiosk**(55) **Reproduktsoon**

DM/066005-01

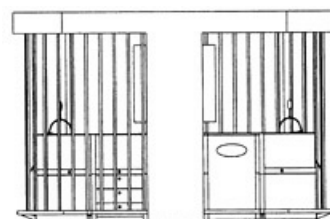
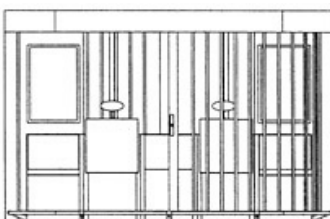
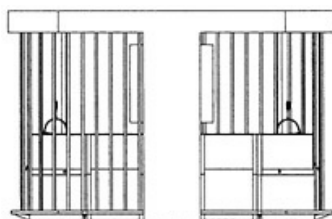
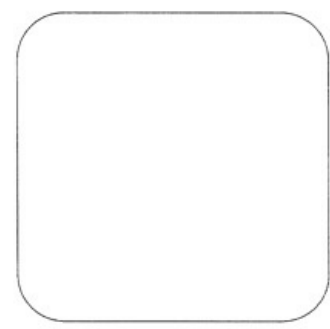
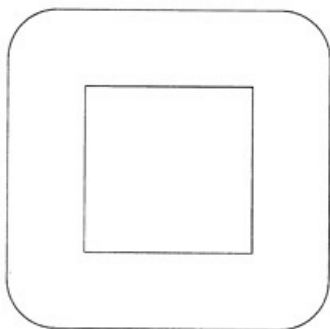
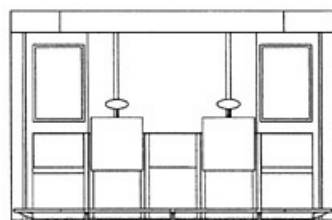
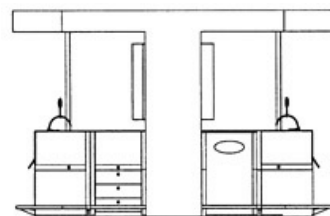
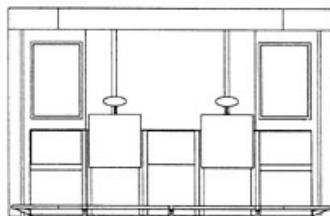
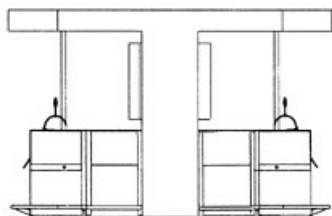

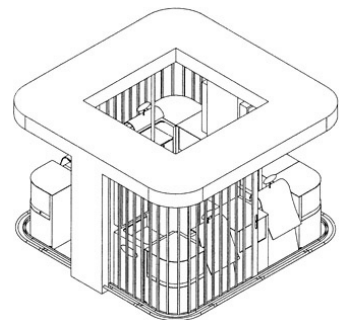
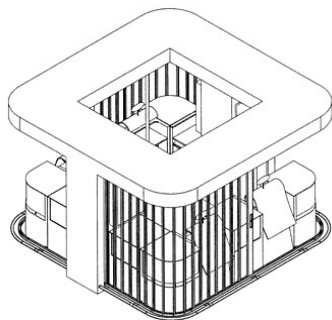
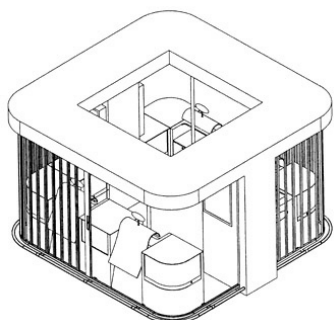
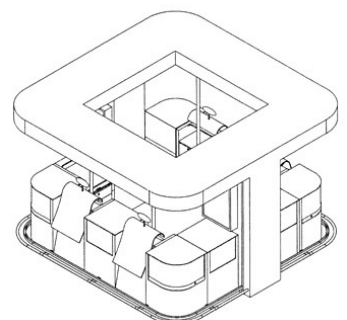
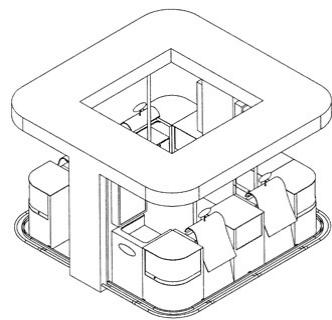
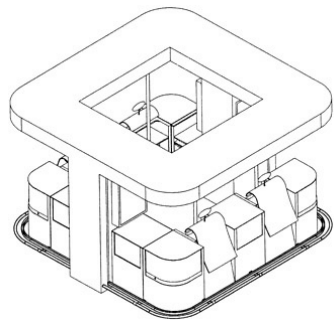
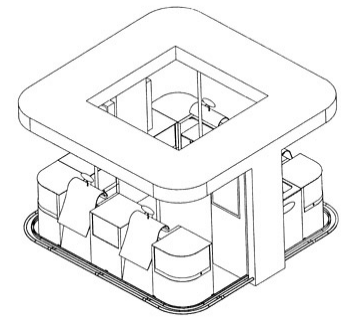
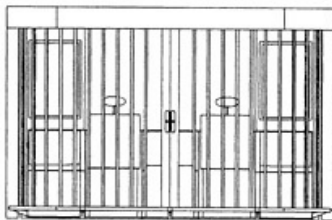
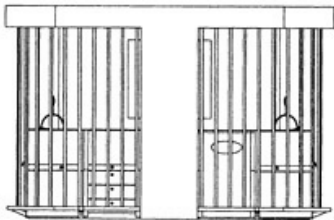
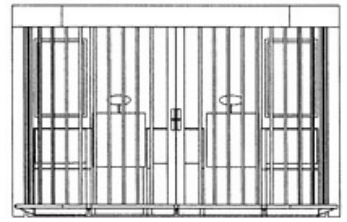
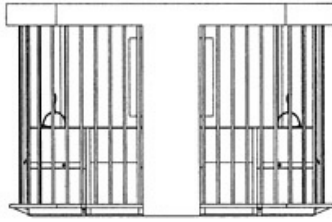
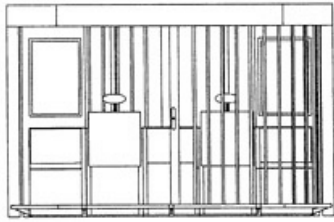



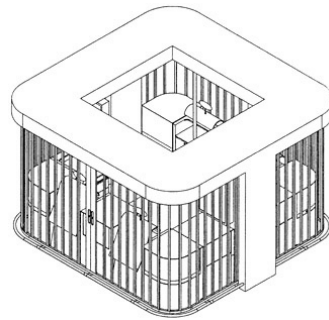
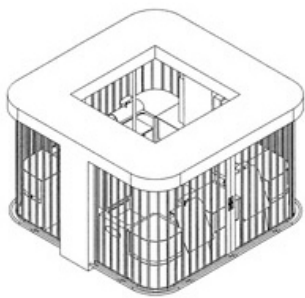
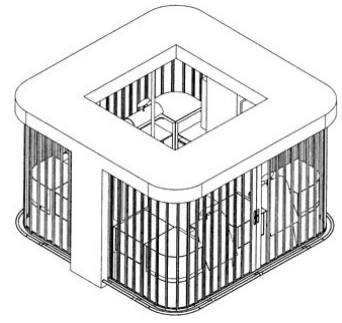
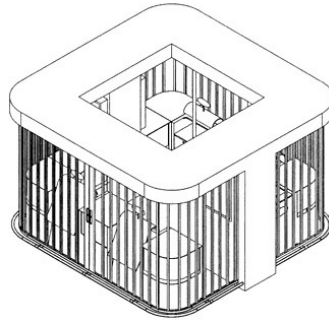
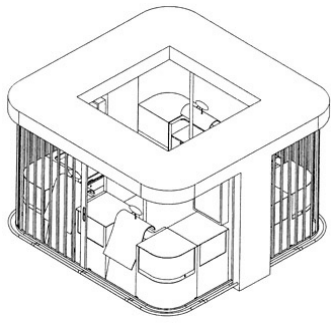

- (11) **Rahvusvah reg nr** **DM/066017** (51) Klass: **10-02**
- (21) **Rahvusvah reg jrk** H200400101
- (15) **Registreeringu päev** 29.10.2004
- (22) **Esitamise päev** 29.10.2004
- (28) **Variantide arv** 3
- (72) **Autor** 1. Walter GARRO, SWATCHLAB, Via Archimede, 6, IT-20129 Milano, IT  
2., 3. Andrea Arrigoni, SWATCHLAB, Via Archimede 6, IT-20129 MILANO, IT
- (73) **Omanik** SWATCH AG (SWATCH SA) (SWATCH LTD.), 94, Rue Jakob Stämpfli, CH-2502 BIENNE, CH

**WIPO Rahvusvah Tööstusdisainilahenduste**  
**Bülletääni nr, kus registreering on avaldatud** 2004/11

(54) **Nimetus** **Wristwatches**

(55) **Reproduksioon**

DM/066017-01



DM/066017-02



DM/066017-03



(11) <b>Rahvusvah reg nr</b>	<b>DM/066040</b>	(51) Klass: <b>10-02</b>
(21) <b>Rahvusvah reg jrk</b>	H200400104	
(15) <b>Registreeringu päev</b>	10.09.2004	
(22) <b>Esitamise päev</b>	10.09.2004	
(28) <b>Variantide arv</b>	1	
(72) <b>Autor</b>	Nicole Dupont, Dupont Design SA, Route des Jeunes 33, CH-1227 CAROUGE, CH	
(73) <b>Omanik</b>	SWATCH AG (SWATCH SA) (SWATCH LTD.), 94, Rue Jakob Stämpfli, CH-2502 BIENNE, CH	

**WIPO Rahvusvah Tööstusdisainilahenduste  
Bülletääni nr, kus registreering on avaldatud** 2004/11

(54) **Nimetus** **Watch**

(55) **Reproduksioon**

DM/066040-01

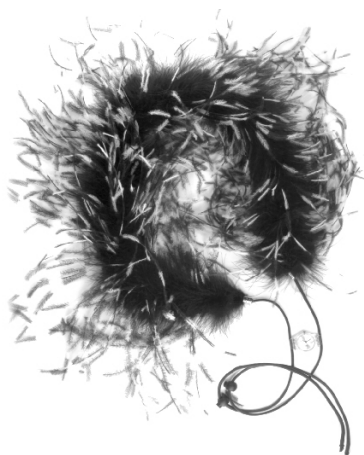

(11) <b>Rahvusvah reg nr</b>	<b>DM/066117</b>	(51) Klass: <b>10-07</b>
(21) <b>Rahvusvah reg jrk</b>	H200500001	
(15) <b>Registreeringu päev</b>	11.10.2004	
(22) <b>Esitamise päev</b>	11.10.2004	
(28) <b>Variantide arv</b>	1	
(30) <b>Prioriteediandmed</b>	175088, 06.05.2004, EM	
(72) <b>Autor</b>	<i>Autori andmeid ei avalikustata</i>	
(73) <b>Omanik</b>	SWAROVSKI AKTIENGESELLSCHAFT, Dröschstrasse 15, FL-9495 Triesen, LI	

**WIPO Rahvusvah Tööstusdisainilahenduste  
Bülletääni nr, kus registreering on avaldatud** 2004/12

(54) **Nimetus** **Mount of a watch face**

(55) **Reproduktsoon**

DM/066117-01

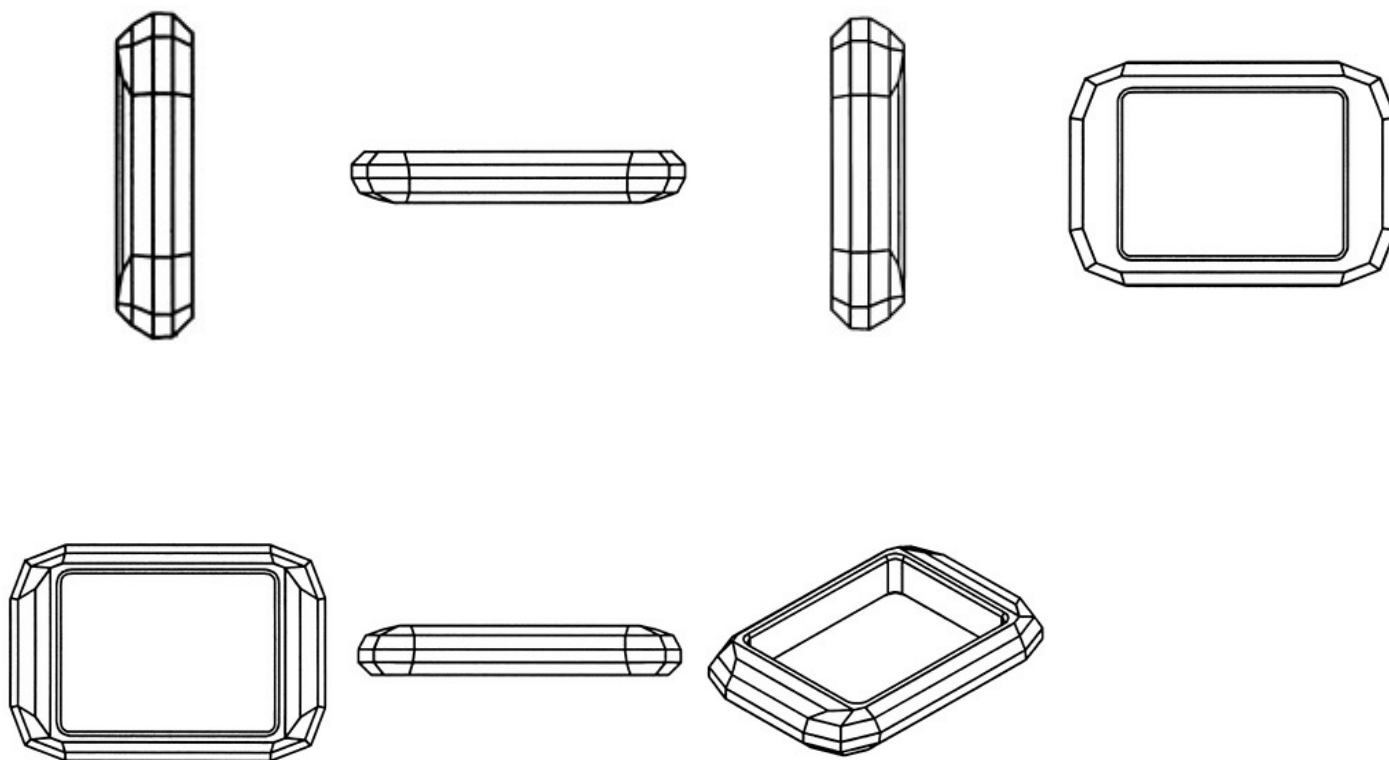

(11) <b>Rahvusvah reg nr</b>	<b>DM/066153</b>	(51) Klass: <b>10-02</b>
(21) <b>Rahvusvah reg jrk</b>	H200500002	
(15) <b>Registreeringu päev</b>	12.11.2004	
(22) <b>Esitamise päev</b>	12.11.2004	
(28) <b>Variantide arv</b>	1	
(72) <b>Autor</b>	Danilo SALA, SWATCHLAB, Via Archimede 6, IT-20129 MILANO, IT	
(73) <b>Omanik</b>	SWATCH AG (SWATCH SA) (SWATCH LTD.), 94, Rue Jakob Stämpfli, CH-2502 BIENNE, CH	
<b>WIPO Rahvusvah Tööstusdisainilahenduste Bülletääni nr, kus registreering on avaldatud</b>	2004/12	

(54) **Nimetus** **Wristwatch**

(55) **Reproduktsoon**

DM/066153-01



(11) <b>Rahvusvah reg nr</b>	<b>DM/066156</b>	(51) Klass: <b>10-02</b>
(21) <b>Rahvusvah reg jrk</b>	H200500005	
(15) <b>Registreeringu päev</b>	15.11.2004	
(22) <b>Esitamise päev</b>	15.11.2004	
(28) <b>Variantide arv</b>	1	
(72) <b>Autor</b>	Corinne KAESER, SWATCH SA, 94, rue Jakob Stämpfli, CH-2502 BIENNE, CH	
(73) <b>Omanik</b>	SWATCH AG (SWATCH SA) (SWATCH LTD.), 94, Rue Jakob Stämpfli, CH-2502 BIENNE, CH	
<b>WIPO Rahvusvah Tööstusdisainilahenduste Bülletääni nr, kus registreering on avaldatud</b>	2004/12	

(54) **Nimetus** **Wristwatch**

(55) **Reproduksioon**

DM/066156-01



(11) **Rahvusvah reg nr****DM/066160**(51) Klass: **10-02**(21) **Rahvusvah reg jrk**

H200500009

(15) **Registreeringu päev**

20.12.2004

(22) **Esitamise päev**

20.12.2004

(28) **Variantide arv**

2

(72) **Autor**1. Katia De Conti, DUPONT DESIGN SA, Rte des Jeunes 33,  
CH-1227 Carouge, CH2. Adelina Bissolo, SWATCHLAB, Via Archimede 6, IT-20129 Milano,  
IT(73) **Omanik**SWATCH AG (SWATCH SA) (SWATCH LTD.), 94, Rue Jakob Stämpfli,  
CH-2502 BIENNE, CH**WIPO Rahvusvah Tööstusdisainilahenduste  
Bülletääni nr, kus registreering on avaldatud**

2004/12

(54) **Nimetus****Wristwatches**(55) **Reproduktsoon**

DM/066160-01



DM/066160-02



(11) <b>Rahvusvah reg nr</b>	<b>DM/066174</b>	(51) Klass: <b>10-07</b>
(21) <b>Rahvusvah reg jrk</b>	H200500010	
(15) <b>Registreeringu päev</b>	01.12.2004	
(22) <b>Esitamise päev</b>	01.12.2004	
(28) <b>Variantide arv</b>	1	
(72) <b>Autor</b>	Eric GIROUD, 19, rue du 31 décembre, CH-1207 Genève, CH	
(73) <b>Omanik</b>	MIDO G. SCHAEAREN & CO. SA (MIDO G. SCHAEAREN & CO. AG) (MIDO G. SCHAEAREN & CO. LTD.), 9, route de Boujean, CH-2500 Bienne, CH	

**WIPO Rahvusvah Tööstusdisainilahenduste  
Bülletääni nr, kus registreering on avaldatud** 2004/12

(54) **Nimetus** **Watch case with strap**

(55) **Reproduksioon**

DM/066174-01





(11) **Rahvusvah reg nr**

**DM/066175**

(51) Klass: **10-07**

(21) **Rahvusvah reg jrk**

H200500011

(15) **Registreeringu päev**

24.11.2004

(22) **Esitamise päev**

24.11.2004

(28) **Variantide arv**

2

(72) **Autor**

Marcelin BOILLAT, Rte de Neuchâtel 142 b, CH-2505 BIENNE, CH

(73) **Omanik**

TISSOT S.A., 17, chemin des Tourelles, CH-2400 Le Locle, CH

**WIPO Rahvusvah Tööstusdisainilahenduste**

**Bülletääni nr, kus registreering on avaldatud** 2004/12

(54) **Nimetus**

**Watch cases with bracelets**

(55) **Reproduktsoon**

DM/066175-01



DM/066175-02



(11) <b>Rahvusvah reg nr</b>	<b>DM/066176</b>	(51) Klass: <b>11-01</b>
(21) <b>Rahvusvah reg jrk</b>	H200500012	
(15) <b>Registreeringu päev</b>	24.11.2004	
(22) <b>Esitamise päev</b>	24.11.2004	
(28) <b>Variantide arv</b>	2	
(72) <b>Autor</b>	Nicolas Barth Nussbaumer, Rue St. Honoré 10, CH-2000 Neuchâtel, CH Nadja Zerunian, CALVIN KLEIN INC. LTD., 205 West 39th Street, 3rd Fl., NEW YORK, NY 10018, US	
(73) <b>Omanik</b>	THE SWATCH GROUP MANAGEMENT SERVICES AG (THE SWATCH GROUP MANAGEMENT SERVICES SA), (THE SWATCH GROUP MANAGEMENT SERVICES LTD.), Seevorstadt 6, CH-2502 BIENNE, CH	

**WIPO Rahvusvah Tööstusdisainilahenduste  
Bülletääni nr, kus registreering on avaldatud** 2004/12

(54) **Nimetus** **Jewelry, particularly rings**

(55) **Reproduksioon**

DM/066176-01

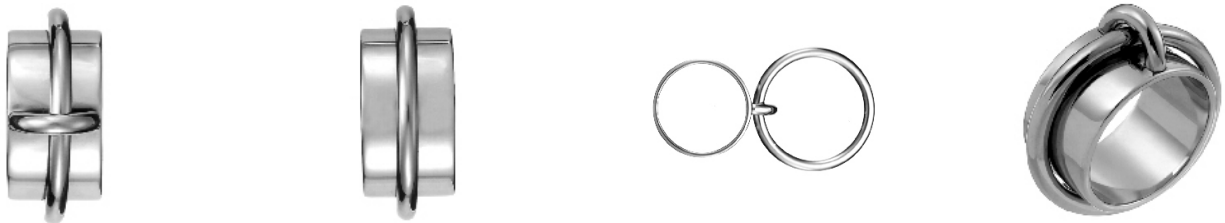

DM/066176-02



(11) <b>Rahvusvah reg nr</b>	<b>DM/066176</b>	(51) Klass: <b>11-01</b>
(21) <b>Rahvusvah reg jrk</b>	H200500012A	
(15) <b>Registreeringu päev</b>	24.11.2004	
(22) <b>Esitamise päev</b>	24.11.2004	
(28) <b>Variantide arv</b>	1	
(72) <b>Autor</b>	Nicolas Barth Nussbaumer, Rue St. Honoré 10, CH-2000 Neuchâtel, CH Nadja Zerunian, CALVIN KLEIN INC. LTD., 205 West 39th Street, 3rd Fl., NEW YORK, NY 10018, US	
(73) <b>Omanik</b>	THE SWATCH GROUP MANAGEMENT SERVICES AG (THE SWATCH GROUP MANAGEMENT SERVICES SA), (THE SWATCH GROUP MANAGEMENT SERVICES LTD.), Seevorstadt 6, CH-2502 BIENNE, CH	

**WIPO Rahvusvah Tööstusdisainilahenduste  
Bülletääni nr, kus registreering on avaldatud** 2004/12

(54) **Nimetus** **Bracelet**

(55) **Reproduksioon**

DM/066176-01



(11) <b>Rahvusvah reg nr</b>	<b>DM/066176</b>	(51) Klass: <b>11-01</b>
(21) <b>Rahvusvah reg jrk</b>	H200500012B	
(15) <b>Registreeringu päev</b>	24.11.2004	
(22) <b>Esitamise päev</b>	24.11.2004	
(28) <b>Variantide arv</b>	1	
(72) <b>Autor</b>	Nicolas Barth Nussbaumer, Rue St. Honoré 10, CH-2000 Neuchâtel, CH Nadja Zerunian, CALVIN KLEIN INC. LTD., 205 West 39th Street, 3rd Fl., NEW YORK, NY 10018, US	
(73) <b>Omanik</b>	THE SWATCH GROUP MANAGEMENT SERVICES AG (THE SWATCH GROUP MANAGEMENT SERVICES SA), (THE SWATCH GROUP MANAGEMENT SERVICES LTD.), Seevorstadt 6, CH-2502 BIENNE, CH	
<b>WIPO Rahvusvah Tööstusdisainilahenduste Bülletääni nr, kus registreering on avaldatud</b>	2004/12	

(54) **Nimetus** **Necklace**

(55) **Reproduksioon**

DM/066176-01



(11) <b>Rahvusvah reg nr</b>	<b>DM/066177</b>	(51) <b>Klass: 10-02</b>
(21) <b>Rahvusvah reg jrk</b>	H200500013	
(15) <b>Registreeringu päev</b>	20.12.2004	
(22) <b>Esitamise päev</b>	20.12.2004	
(28) <b>Variantide arv</b>	2	
(72) <b>Autor</b>	1, 2 Léonie Cocquio, Dupont Design SA, Rte des Jeunes 33, CH-1227 Carouge, CH	
(73) <b>Omanik</b>	SWATCH AG (SWATCH SA) (SWATCH LTD.), 94, Rue Jakob Stämpfli, CH-2502 BIENNE, CH	
<b>WIPO Rahvusvah Tööstusdisainilahenduste Bülletääni nr, kus registreering on avaldatud</b>	2004/12	

(54) **Nimetus** **Wristwatches**

(55) **Reproduktsoon**

DM/066177-01



DM/066177-02



(11) <b>Rahvusvah reg nr</b>	<b>DM/066180</b>	(51) Klass: <b>10-02</b>
(21) <b>Rahvusvah reg jrk</b>	H200500016	
(15) <b>Registreeringu päev</b>	20.12.2004	
(22) <b>Esitamise päev</b>	20.12.2004	
(28) <b>Variantide arv</b>	1	
(72) <b>Autor</b>	Davide MARIANI, SWATCHLAB, Via Archimede 6, IT-20129 MILANO, IT	
(73) <b>Omanik</b>	SWATCH AG (SWATCH SA) (SWATCH LTD.), 94, Rue Jakob Stämpfli, CH-2502 BIENNE, CH	
<b>WIPO Rahvusvah Tööstusdisainilahenduste Bülletääni nr, kus registreering on avaldatud</b>	2004/12	

(54) **Nimetus** **Wristwatch**

(55) **Reproduksioon**

DM/066180-01



- (11) **Rahvusvah reg nr** **DM/066183** (51) Klass: **10-02**
- (21) **Rahvusvah reg jrk** H200500019
- (15) **Registreeringu päev** 20.12.2004
- (22) **Esitamise päev** 20.12.2004
- (28) **Variantide arv** 3
- (72) **Autor** 1. Léonie Cocquio, DUPONT DESIGN SA, Rte des Jeunes 33, CH-1227 Carouge, CH  
2. Adelina Bissolo, SWATCHLAB, Via Archimede 6, IT-20129 Milano, IT  
3. Léonie Cocquio, DUPONT DESIGN SA, Rte des Jeunes 33, CH-1227 Carouge, CH
- (73) **Omanik** SWATCH AG (SWATCH SA) (SWATCH LTD.), 94, Rue Jakob Stämpfli, CH-2502 BIENNE, CH

**WIPO Rahvusvah Tööstusdisainilahenduste Bülletääni nr, kus registreering on avaldatud** 2004/12

(54) **Nimetus** **Wristwatches**

(55) **Reproduksioon**

DM/066183-01



DM/066183-02



DM/066183-03





**III. REGISTREERINGU KEHTIVUSE PIKENDAMINE**

(11)	(18)
00459	03.05.2010
00470	19.06.2010
00471	05.07.2010
00472	06.07.2010
00474	11.07.2010
00475	11.07.2010
00476	11.07.2010
00480	26.07.2010
00482	26.07.2010
00483	26.07.2010
00498	26.07.2010

**IV. TÖÖSTUSDISAINILAHENDUSE ÜLEMINEK**

Reg nr	Uue omaniku andmed	Registrikande jõustumise päev
00969	Sternoberg OÜ, Kosevälja 11, Kose, Võru vald, 65502 Võru maakond, EE	06.05.2005

**VI. MUUD REGISTREERINGU ANDMETE MUUDATUSED**

Reg nr	Muudetud andmed	Registrikande jõustumise päev
00926	(72) (73) Veljo Kurik, F.R. Kreutzwaldi 12, 10124 Tallinn, EE	07.06.2005
00993	(72) (73) Veljo Kurik, F.R. Kreutzwaldi 12, 10124 Tallinn, EE	07.06.2005

**XI. TÖÖSTUSDISAINILAHENDUSE KUSTUTAMINE REGISTRIST**

"Tööstusdisaini kaitse seaduse" paragrahvi 77 lõike 1 alusel on registrist kustutatud järgmised tööstusdisainilahendused:

Reg nr	Kustutamise jõustumise päev
--------	-----------------------------

00397	26.10.2004
00399	29.10.2004
00403	16.11.2004
00418	29.11.2004
00419	20.12.2004
00437	25.11.2004
00439	21.12.2004
00443	07.12.2004

## XII. LOENDID

## REGISTREERITUD TÖÖSTUSDISAINILAHENDUSTE SÜSTEMAATILINE LOEND

Rahvusvahelise klassifikatsiooni klass ja alaklass(id)	Registreerimis-taotluse number	Registreeringu number			
06-01	D200500022	01077	14-03	D200500006	01095
06-01	D200500024	01079	14-03	D200500007	01096
06-01	D200500026	01081	14-03	D200500008	01097
06-01	D200500027	01083	14-03	D200500009	01098
06-01	D200500029	01082	14-03	D200500015	01075
06-01	D200500033	01088	14-03	D200500016	01099
06-01	D200500034	01089	14-03	D200500017	01076
06-01	D200500035	01090	14-03	D200500040	01108
06-01	D200500038	01093	14-03	D200500041	01100
09-01	D200500005	01074	14-03	D200500042	01110
09-01	D200500020	01072	14-03	D200500043	01111
09-03	D200500018	01070	14-03	D200500045	01101
09-09	D200500023	01078	14-03	D200500046	01102
09-09	D200500025	01080	14-03	D200500047	01103
09-09	D200500036	01091	14-03	D200500048	01104
09-09	D200500037	01092	14-03	D200500049	01105
09-09	D200500039	01094	14-03	D200500051	01109
09-99	D200500052	01113	19-08	D200500052	01113
11-02	D200500044	01112	23-01	D200500028	01087
12-16	D200500019	01071	23-01	D200500030	01084
14-01	D200500045	01101	23-01	D200500031	01085
14-01	D200500046	01102	23-02	D200500021	01073
14-01	D200500047	01103	24-01	D200500021	01073
14-02	D200500045	01101	27-03	D200500032	01086
14-02	D200500046	01102	28-01	D200400033	01106
14-02	D200500047	01103	28-01	D200400033A	01107

## REGISTREERITUD TÖÖSTUSDISAINILAHENDUSTE REGISTREERIMISTAOTLUSTE NUMBRILINE LOEND

Registreerimis-taotluse number	Registreeringu number	Rahvusvahelise klassifikatsiooni klass(id) ja alaklass(id)			
D200400033	01106	28-01	D200500023	01078	09-09
D200400033A	01107	28-01	D200500024	01079	06-01
D200500005	01074	09-01	D200500025	01080	09-09
D200500006	01095	14-03	D200500026	01081	06-01
D200500007	01096	14-03	D200500027	01083	06-01
D200500008	01097	14-03	D200500028	01087	23-01
D200500009	01098	14-03	D200500029	01082	06-01
D200500015	01075	14-03	D200500030	01084	23-01
D200500016	01099	14-03	D200500031	01085	23-01
D200500017	01076	14-03	D200500032	01086	27-03
D200500018	01070	09-03	D200500033	01088	06-01
D200500019	01071	12-16	D200500034	01089	06-01
D200500020	01072	09-01	D200500035	01090	06-01
D200500021	01073	23-02	D200500036	01091	09-09
D200500021	01073	24-01	D200500037	01092	09-09
D200500022	01077	06-01	D200500038	01093	06-01

Registreerimis- taotluse number	Registreeringu number	Rahvusvahelise klassifikatsiooni klass(id) ja alaklass(id)
------------------------------------	--------------------------	--

D200500039	01094	09-09	D200500046	01102	14-02
D200500040	01108	14-03	D200500046	01102	14-03
D200500041	01100	14-03	D200500047	01103	14-01
D200500042	01110	14-03	D200500047	01103	14-02
D200500043	01111	14-03	D200500047	01103	14-03
D200500044	01112	11-02	D200500048	01104	14-03
D200500045	01101	14-01	D200500049	01105	14-03
D200500045	01101	14-02	D200500051	01109	14-03
D200500045	01101	14-03	D200500052	01113	09-99
D200500046	01102	14-01	D200500052	01113	19-08

**AVALDATUD RAHVUSVAHELISE REGISTREERINGU REGISTREERIMISE  
OTSUSE TEADETE NUMBRILINE LOEND**

DM/065469	DM/065958	DM/066156	DM/066176
DM/065839	DM/066005	DM/066160	DM/066177
DM/065839	DM/066017	DM/066174	DM/066180
DM/065895	DM/066040	DM/066175	DM/066183
DM/065941	DM/066117	DM/066176	
DM/065957	DM/066153	DM/066176	

**XIII. TÖÖSTUSDISAINIALASED ÕIGUSAKTID JA MUU INFO****RIIKLIKUS PATENDIVOLNIKE REGISTRIS REGISTREERITUD PATENDIVOLNIKE NIMEKIRI**  
(seisuga 25. mai 2005)

Register on asutatud 1. septembril 2001. a Vabariigi Valitsuse 7. augusti 2001. a määrusega nr 271 "Riikliku patendivolinike registri asutamine ja registri pidamise põhimäärus" (RT I 2001, 70, 426) patendivoliniku seaduse § 21 alusel (RT I 2001, 27, 151).

**TEGEVUSVALDKOND: KAUBAMÄRK, TÖÖSTUSDISAINILAHENDUS JA GEOGRAAFILINE TÄHIS**

<b>Arno ANIJALG</b>	<b>OÜ USTERVALL</b> Raekoja plats 16 51004 Tartu pk 21, 50002 Tartu telefon: 744 1980 telefaks: 744 1785 e-post: anijalg@ustervall.ee <a href="http://www.ustervall.ee">http://www.ustervall.ee</a> võõrkeeled: saksa, vene	<b>Juhan HÄMMALOV</b>	<b>OÜ Intels</b> Riia 11-3 51010 Tartu telefon: 742 0401 telefaks: 742 0326 e-post: intelses@estpak.ee võõrkeeled: inglise, saksa, vene
<b>Aivo ARULA</b>	<b>Patendibüroo Käosaar &amp; Co OÜ</b> Tähe 94 50107 Tartu telefon: 738 3051 telefaks: 738 3055 e-post: info@kaosaar.ee <a href="http://www.kaosaar.ee">http://www.kaosaar.ee</a> võõrkeeled: inglise, vene	<b>Uno JÄÄGER</b>	<b>Inseneribüroo Uneko OÜ</b> Rüütli 51a, 80010 Pärnu telefon: 447 1021 telefaks: 447 1001 GSM: 515 1844 e-post: uno@estpak.ee võõrkeeled: inglise, soome, vene
<b>Martina BÖCKLER-LORVI</b>	<b>OÜ LASVET</b> Suurtüki 4a, 10133 Tallinn pk 3136, 10505 Tallinn telefon: 640 6600 telefaks: 640 6604 e-post: lasvet@lasvet.ee <a href="http://www.lasvet.ee">http://www.lasvet.ee</a> võõrkeeled: inglise, soome	<b>Sirje KAHU</b>	<b>OÜ USTERVALL</b> Raekoja plats 16 51004 Tartu pk 21, 50002 Tartu telefon: 744 1980 telefaks: 744 1785 e-post: skahu@ustervall.ee <a href="http://www.ustervall.ee">http://www.ustervall.ee</a> võõrkeeled: inglise, vene
<b>Indrek EELMETS</b>	<b>OÜ LASVET</b> Suurtüki 4a, 10133 Tallinn pk 3136, 10505 Tallinn telefon: 640 6600 telefaks: 640 6604 e-post: lasvet@lasvet.ee <a href="http://www.lasvet.ee">http://www.lasvet.ee</a> võõrkeeled: inglise, vene, soome	<b>Lembit KALEV</b>	<b>Patendibüroo ROOSILLA OÜ</b> Järveotsa tee 39-61 13520 Tallinn telefon: 657 1722, 657 5381 telefaks: 657 5381 GSM: 511 9951 e-post: roosilla@roosilla.ee <a href="http://www.roosilla.ee">http://www.roosilla.ee</a> võõrkeeled: inglise, vene
<b>Alla HÄMMALOV</b>	<b>OÜ Intels</b> Riia 11-3 51010 Tartu telefon: 742 0401 telefaks: 742 0326 e-post: intelses@estpak.ee võõrkeeled: inglise, poola, vene	<b>Anneli KANG</b>	<b>OÜ Synest</b> pk 977, 13402 Tallinn telefon: 660 9786 telefaks: 660 9787 e-post: anneli@synest.ee võõrkeeled: inglise, saksa, vene, prantsuse, soome, rootsi

- Urmas KAULER**      **Patendibüroo TURVAJA OÜ**  
Liivalaia 22  
10118 Tallinn  
telefon: 640 3109  
telefaks: 640 3105  
e-post: kauler@turvaja.ee  
http://www.turvaja.ee  
võõrkeeled: inglise, vene, soome
- Urmas KERNU**      **AAA Patendibüroo OÜ**  
Tartu mnt 16  
10117 Tallinn  
pk 3926, 10509 Tallinn  
telefon: 660 5910, 660 5911  
telefaks: 660 5912  
e-post: aaa@aaa.ee  
http://www.aaa.ee  
võõrkeeled: inglise, saksa, soome, vene
- Ljubov KESSELMAN**      **OÜ Kesna**  
Tedre 77-52  
10616 Tallinn  
telefon: 660 8068  
telefaks: 660 8069  
e-post: kesna@online.ee  
võõrkeeled: inglise, vene
- Marina KESSELMAN**      **OÜ Kesna**  
Tedre 77-52  
10616 Tallinn  
telefon: 660 8068  
telefaks: 660 8069  
e-post: kesna@online.ee  
võõrkeeled: inglise, saksa, vene
- Heinu KOITEL**      **Patendi- & Kaubamärgibüroo Koitel OÜ**  
Tartu mnt 65  
10115 Tallinn  
pk 1759, 10902 Tallinn  
telefon: 603 3260  
telefaks: 603 3261  
e-post: koitel@koitel.ee  
http://www.koitel.ee  
võõrkeeled: inglise, soome, vene
- Raivo KOITEL**      **Patendi- & Kaubamärgibüroo Koitel OÜ**  
Tartu mnt 65  
10115 Tallinn  
pk 1759, 10902 Tallinn  
telefon: 603 3260  
telefaks: 603 3261  
e-post: koitel@koitel.ee  
http://www.koitel.ee  
võõrkeeled: inglise, soome, vene
- Mart Enn KOPPEL**      **Patendibüroo Koppel OÜ**  
Kajaka 4-10  
11317 Tallinn  
telefon: 677 4136  
telefaks: 677 4138  
e-post: info@koppelpb.com  
http://www.koppelpb.com  
võõrkeeled: inglise, vene, soome
- Heinrich KRUPP**      **Patendibüroo TURVAJA OÜ**  
Liivalaia 22  
10118 Tallinn  
telefon: 640 3109  
telefaks: 640 3105  
e-post: turvaja@turvaja.ee  
http://www.turvaja.ee  
võõrkeeled: saksa, vene
- Jüri KÄOSAAR**      **Patendibüroo Käosaar & Co OÜ**  
Tähe 94  
50107 Tartu  
telefon: 738 3051  
telefaks: 738 3055  
e-post: info@kaosaar.ee  
http://www.kaosaar.ee  
võõrkeeled: inglise, vene
- Kalev KÄOSAAR**      **Patendibüroo Käosaar & Co OÜ**  
Peterburi tee 46  
11415 Tallinn  
telefon: 637 9484  
telefaks: 637 9485  
e-post: kalev.kaosaar@kaosaar.ee  
http://www.kaosaar.ee  
võõrkeeled: inglise, vene
- Reet MAASIKAMÄE**      **OÜ Kaitsepurus**  
Mulla 4-3  
10611 Tallinn  
telefon: 673 9097, 633 2798  
telefaks: 677 4844  
e-post: purus@online.ee  
purus@hot.ee  
http://www.hot.ee/purus/  
võõrkeeled: inglise, vene
- Raivo MATSOO**      **RM Hirvela Patendibüroo OÜ**  
Saku 15, 11314 Tallinn  
telefon: 614 0816  
telefaks: 614 0818  
e-post: hirvela@hirvela.ee  
võõrkeeled: inglise, vene

<b>Elle MELLIK</b>	<b>AAA Patendibüroo OÜ</b> Tartu mnt 16 10117 Tallinn pk 3926, 10509 Tallinn telefon: 660 5910, 660 5911 telefaks: 660 5912 e-post: aaa@aaa.ee http://www.aaa.ee võõrkeeled: inglise, vene	<b>Jaak OSTRAT</b>	<b>OÜ LASVET</b> Suurtüki 4a, 10133 Tallinn pk 3136, 10505 Tallinn telefon: 640 6600 telefaks: 640 6604 e-post: lasvet@lasvet.ee http://www.lasvet.ee võõrkeeled: inglise, saksa, soome, vene
<b>Lembit MITT</b>	<b>AAA Patendibüroo OÜ</b> Tartu mnt 16 10117 Tallinn pk 3926, 10509 Tallinn telefon: 660 5910, 660 5911 telefaks: 660 5912 e-post: aaa@aaa.ee http://www.aaa.ee võõrkeeled: inglise, vene	<b>Villu PAVELTS</b>	<b>OÜ LASVET</b> Suurtüki 4a, 10133 Tallinn pk 3136, 10505 Tallinn telefon: 640 6600 telefaks: 640 6604 e-post: lasvet@lasvet.ee http://www.lasvet.ee võõrkeeled: inglise, soome, vene
<b>Ott MOORLAT</b>	<b>OÜ Moorlat &amp; Ko Patendibüroo</b> pk 723, 12902 Tallinn telefon: 655 0450, 654 2844 telefaks: 654 2844 e-post: ott.moorlat@moorlat.ee http://www.moorlat.ee võõrkeeled: inglise, vene	<b>Toom PUNGAS</b>	<b>OÜ Synest</b> pk 977, 13402 Tallinn telefon: 660 9786 telefaks: 660 9787 e-post: toom@synest.ee võõrkeeled: inglise, saksa, soome, vene
<b>Anfia MORNA</b>	<b>Patendibüroo TURVAJA OÜ</b> Liivalaia 22, 10118 Tallinn telefon: 640 3109 telefaks: 640 3105 e-post: morna@turvaja.ee http://www.turvaja.ee võõrkeeled: inglise, vene	<b>Kaie PUUR</b>	<b>Patendibüroo Käosaar &amp; Co OÜ</b> Tähe 94 50107 Tartu telefon: 738 3051 telefaks: 738 3055 e-post: info@kaosaar.ee http://www.kaosaar.ee võõrkeeled: inglise, vene
<b>Tõnu NELSAS</b>	<b>AAA Patendibüroo OÜ</b> Tartu mnt 16 10117 Tallinn pk 3926, 10509 Tallinn telefon: 660 5910, 660 5911 telefaks: 660 5912 e-post: aaa@aaa.ee http://www.aaa.ee võõrkeeled: inglise, vene, soome	<b>Riina PÄRN</b>	<b>OÜ Intels</b> Riia 11-3 51010 Tartu telefon: 742 0401 telefaks: 742 0326 e-post: intelses@estpak.ee võõrkeeled: inglise, vene
<b>Jüri OLT</b>	<b>Patendibüroo Käosaar &amp; Co OÜ</b> Tähe 94, 50107 Tartu telefon: 738 3051 telefaks: 738 3055 e-post: info@kaosaar.ee http://www.kaosaar.ee võõrkeeled: inglise, saksa, soome, vene	<b>Tarmo ROSMAN</b>	<b>Rosman ja Partnerid OÜ</b> pk 652, 12602 Tallinn telefon: 656 1450 telefaks: 656 1450 e-post: tarman@cc.ttu.ee võõrkeeled: saksa, inglise, ungari, vene
		<b>Arvo SALUMÄE</b>	<b>OÜ Amende Patendibüroo</b> Raua 65 10152 Tallinn telefon: 648 6125 telefaks: 641 0174 e-post: amende@hot.ee võõrkeeled: inglise, saksa, soome, vene

**Almar SEHVER****AAA Patendibüroo OÜ**

Tartu mnt 16  
10117 Tallinn  
pk 3926, 10509 Tallinn  
telefon: 660 5910, 660 5911  
telefaks: 660 5912  
e-post: aaa@aaa.ee  
<http://www.aaa.ee>  
võõrkeeled: inglise, vene

**Enn URGAS****Patendibüroo TURVAJA OÜ**

Liivalaia 22  
10118 Tallinn  
telefon: 640 3109  
telefaks: 640 3105  
e-post: [urgas@turvaja.ee](mailto:urgas@turvaja.ee)  
<http://www.turvaja.ee>  
võõrkeeled: inglise, vene

**Harald TEHVER****Patendibüroo TURVAJA OÜ**

Liivalaia 22  
10118 Tallinn  
telefon: 640 3109  
telefaks: 640 3105  
e-post: [tehver@turvaja.ee](mailto:tehver@turvaja.ee)  
<http://www.turvaja.ee>  
võõrkeeled: inglise, saksa, vene

**Juta-Maris UUSTALU OÜ LASVET**

Suurtüki 4a, 10133 Tallinn  
pk 3136, 10505 Tallinn  
telefon: 640 6600  
telefaks: 640 6604  
e-post: [lasvet@lasvet.ee](mailto:lasvet@lasvet.ee)  
<http://www.lasvet.ee>  
võõrkeeled: inglise, vene

**Olga TREUFELDT****Patendibüroo TURVAJA OÜ**

Liivalaia 22  
10118 Tallinn  
telefon: 640 3109  
telefaks: 640 3105  
e-post: [olga@turvaja.ee](mailto:olga@turvaja.ee)  
<http://www.turvaja.ee>  
võõrkeeled: inglise, vene

**LIST OF PATENT ATTORNEYS, REGISTERED IN  
THE ESTONIAN STATE REGISTER OF PATENT ATTORNEYS  
(by 25 May 2005)**

Register is established on September 1<sup>st</sup> 2001

**FIELD OF ACTIVITY: TRADEMARKS, INDUSTRIAL DESIGNS AND GEOGRAPHICAL INDICATIONS**

<b>Arno ANIJALG</b>	<b>USTERVALL Ltd.</b> Raekoja plats 16 51004 Tartu, Estonia P.O. Box 21 50002 Tartu, Estonia Phone: +372 744 1980 Fax: +372 744 1785 E-mail: anijalg@ustervall.ee Http://www.ustervall.ee German, Russian, Estonian	<b>Juhan HÄMMALOV</b>	<b>Intels Ltd.</b> Riia Str. 11-3 51010 Tartu, Estonia Phone: +372 742 0401 Fax: +372 742 0326 E-mail: intelses@estpak.ee English, German, Russian, Estonian
<b>Aivo ARULA</b>	<b>Patent Agency Käosaar &amp; Co</b> Tähe Str. 94 50107 Tartu, Estonia Phone: +372 738 3051 Fax: +372 738 3055 E-mail: info@kaosaar.ee Http://www.kaosaar.ee English, Russian, Estonian	<b>Uno JÄÄGER</b>	<b>Inseneribüroo Uneko Ltd.</b> Rüütli 51a 80010 Pärnu, Estonia Phone: +372 447 1021 Fax: +372 447 1001 GSM: +372 515 1844 E-mail: uno@estpak.ee English, Finnish, Russian, Estonian
<b>Martina BÖCKLER-LORVI</b>	<b>Lasvet Ltd.</b> P.O. Box 3136 10505 Tallinn, Estonia Phone: +372 640 6600 Fax: +372 640 6604 E-mail: lasvet@lasvet.ee Http://www.lasvet.ee English, Finnish, Estonian	<b>Sirje KAHU</b>	<b>USTERVALL Ltd.</b> Raekoja plats 16 51004 Tartu, Estonia P.O. Box 21 50002 Tartu, Estonia Phone: +372 744 1980 Fax: +372 744 1785 E-mail: skahu@ustervall.ee Http://www.ustervall.ee English, Russian, Estonian
<b>Indrek EELMETS</b>	<b>Lasvet Ltd.</b> P.O. Box 3136 10505 Tallinn, Estonia Phone: +372 640 6600 Fax: +372 640 6604 E-mail: lasvet@lasvet.ee Http://www.lasvet.ee English, Finnish, Russian, Estonian	<b>Lembit KALEV</b>	<b>Patent Bureau ROOSILLA Ltd.</b> Järveotsa Road 39-61 13520 Tallinn, Estonia Phone: +372 657 1722 +372 657 5381 Fax: +372 657 5381 GSM: +372 511 9951 E-mail: roosilla@roosilla.ee Http://www.roosilla.ee English, Russian, Estonian
<b>Alla HÄMMALOV</b>	<b>Intels Ltd.</b> Riia Str. 11-3 51010 Tartu, Estonia Phone: +372 742 0401 Fax: +372 742 0326 E-mail: intelses@estpak.ee English, Polish, Russian, Estonian	<b>Anneli KANG</b>	<b>Synest Ltd.</b> P.O. Box 977 13402 Tallinn, Estonia Phone: +372 660 9786 Fax: +372 660 9787 E-mail: anneli@synest.ee English, German, Russian, French, Finnish, Swedish, Estonian



- Urmast KAULER**      **Patendibüroo TURVAJA OÜ**  
 Liivalaia 22  
 10118 Tallinn, Estonia  
 Phone: +372 640 3109  
 Fax: +372 640 3105  
 E-mail: kauler@turvaja.ee  
 Http://www.turvaja.ee  
 English, Russian, Finnish,  
 Estonian
- Urmast KERNU**      **AAA Legal Services**  
 Tartu Road 16  
 10117 Tallinn, Estonia  
 P.O. Box 3926  
 10509 Tallinn, Estonia  
 Phone: +372 660 5910  
 +372 660 5911  
 Fax: +372 660 5912  
 E-mail: aaa@aaa.ee  
 Http://www.aaa.ee  
 English, German, Finnish,  
 Russian, Estonian
- Marina KESSELMAN**      **Kesna Ltd.**  
 Tedre Str. 77-52  
 10616 Tallinn, Estonia  
 Phone: +372 660 8068  
 Fax: +372 660 8069  
 E-mail: kesna@online.ee  
 English, German, Russian,  
 Estonian
- Ljubov KESSELMAN**      **Kesna Ltd.**  
 Tedre Str. 77-52  
 10616 Tallinn, Estonia  
 Phone: +372 660 8068  
 Fax: +372 660 8069  
 E-mail: kesna@online.ee  
 English, Russian, Estonian
- Heinu KOITEL**      **Patent- & Trademark Office  
 Koitel Ltd.**  
 Tartu Road 65  
 10115 Tallinn, Estonia  
 P.O. Box 1759  
 10902 Tallinn, Estonia  
 Phone: +372 603 3260  
 Fax: +372 603 3261  
 E-mail: koitel@koitel.ee  
 Http://www.koitel.ee  
 English, Finnish, Russian,  
 Estonian
- Raivo KOITEL**      **Patent- & Trademark Office  
 Koitel Ltd.**  
 Tartu Road 65  
 10115 Tallinn, Estonia  
 P.O. Box 1759  
 10902 Tallinn, Estonia  
 Phone: +372 603 3260  
 Fax: +372 603 3261  
 E-mail: koitel@koitel.ee  
 Http://www.koitel.ee  
 English, Finnish, Russian,  
 Estonian
- Mart Enn KOPPEL**      **Patent Bureau Koppel**  
 Kajaka 4-10  
 11317 Tallinn, Estonia  
 Phone: +372 677 4136  
 Fax: +372 677 4138  
 E-mail: info@koppelpb.com  
 Http://www.koppelpb.com  
 English, Russian, Finnish,  
 Estonian
- Heinrich KRUPP**      **Patendibüroo TURVAJA OÜ**  
 Liivalaia 22  
 10118 Tallinn, Estonia  
 Phone: +372 640 3109  
 Fax: +372 640 3105  
 E-mail: turvaja@turvaja.ee  
 Http://www.turvaja.ee  
 German, Russian, Estonian
- Jüri KÄOSAAR**      **Patent Agency Käosaar & Co**  
 Tähe Str. 94  
 50107 Tartu, Estonia  
 Phone: +372 738 3051  
 Fax: +372 738 3055  
 E-mail: info@kaosaar.ee  
 Http://www.kaosaar.ee  
 English, Russian, Estonian
- Kalev KÄOSAAR**      **Patent Agency Käosaar & Co**  
 Peterburi Road 46  
 11415 Tallinn, Estonia  
 Phone: +372 637 9484  
 Fax: +372 637 9485  
 E-mail:  
 kalev.kaosaar@kaosaar.ee  
 Http://www.kaosaar.ee  
 English, Russian, Estonian

- Reet MAASIKAMÄE Patent Bureau Kaitsepurus Ltd.**  
Mulla Str. 4-3  
10611 Tallinn, Estonia  
Phone: +372 673 9097  
+372 633 2798  
Fax: +372 677 4844  
E-mail: purus@online.ee  
purus@hot.ee  
Http://www.hot.ee/purus/  
English, Russian, Estonian
- Raivo MATSOO RM Hirvela Patent Bureau Ltd**  
Saku 15, 11314 Tallinn, Estonia  
Phone: +372 614 0816  
Fax: +372 614 0818  
E-mail: hirvela@hirvela.ee  
English, Russian, Estonian
- Elle MELLIK AAA Legal Services**  
Tartu Road 16  
10117 Tallinn, Estonia  
P.O. Box 3926  
10509 Tallinn, Estonia  
Phone: +372 660 5910  
+372 660 5911  
Fax: +372 660 5912  
E-mail: aaa@aaa.ee  
Http://www.aaa.ee  
English, Russian, Estonian
- Lembit MITT AAA Legal Services**  
Tartu Road 16  
10117 Tallinn, Estonia  
P.O. Box 3926  
10509 Tallinn, Estonia  
Phone: +372 660 5910  
+372 660 5911  
Fax: +372 660 5912  
E-mail: aaa@aaa.ee  
Http://www.aaa.ee  
English, Russian, Estonian
- Ott MOORLAT Moorlat & Co Ltd. Patent Bureau**  
P.O. Box 723  
12902 Tallinn, Estonia  
Phone: +372 655 0450  
+372 654 2844  
Fax: +372 654 2844  
E-mail: ott.moorlat@moorlat.ee  
Http://www.moorlat.ee  
English, Russian, Estonian
- Anfia MORNA**
- Tõnu NELSAS AAA Legal Services**  
Tartu Road 16  
10117 Tallinn, Estonia  
P.O. Box 3926  
10509 Tallinn, Estonia  
Phone: +372 660 5910  
+372 660 5911  
Fax: +372 660 5912  
E-mail: aaa@aaa.ee  
Http://www.aaa.ee  
English, Russian, Finnish, Estonian
- Jüri OLT Patent Agency Käosaar & Co**  
Tähe Str. 94  
50107 Tartu, Estonia  
Phone: +372 738 3051  
Fax: +372 738 3055  
E-mail: info@kaosaar.ee  
Http://www.kaosaar.ee  
English, German, Finnish, Russian, Estonian
- Jaak OSTRAT Lasvet Ltd.**  
P.O. Box 3136  
10505 Tallinn, Estonia  
Phone: +372 640 6600  
Fax: +372 640 6604  
E-mail: lasvet@lasvet.ee  
Http://www.lasvet.ee  
English, German, Finnish, Russian, Estonian
- Villu PAVELTS Lasvet Ltd.**  
P.O. Box 3136  
10505 Tallinn, Estonia  
Phone: +372 640 6600  
Fax: +372 640 6604  
E-mail: lasvet@lasvet.ee  
Http://www.lasvet.ee  
English, Finnish, Russian, Estonian
- Toom PUNGAS Synest Ltd.**  
P.O. Box 977  
13402 Tallinn, Estonia  
Phone: +372 660 9786  
Fax: +372 660 9787  
E-mail: toom@synest.ee  
English, German, Finnish, Russian, Estonian
- Patendibüroo TURVAJA OÜ**  
Liivalaia 22  
10118 Tallinn, Estonia  
Phone: +372 640 3109  
Fax: +372 640 3105  
E-mail: morna@turvaja.ee  
Http://www.turvaja.ee  
English, Russian, Estonian

- Kaie PUUR**      **Patent Agency Käosaar & Co**  
Tähe Str. 94  
50107 Tartu, Estonia  
Phone: +372 738 3051  
Fax: +372 738 3055  
E-mail: info@kaosaar.ee  
Http://www.kaosaar.ee  
English, Russian, Estonian
- Harald TEHVER**      **Patendibüroo TURVAJA OÜ**  
Liivalaia 22  
10118 Tallinn, Estonia  
Phone: +372 640 3109  
Fax: +372 640 3105  
E-mail: tehver@turvaja.ee  
Http://www.turvaja.ee  
English, German, Russian,  
Estonian
- Riina PÄRN**      **Intels Ltd.**  
Riia Str. 11-3  
51010 Tartu, Estonia  
Phone: +372 742 0401  
Fax: +372 742 0326  
E-mail: intelses@estpak.ee  
English, Russian,  
Estonian
- Olga TREUFELDT**      **Patendibüroo TURVAJA OÜ**  
Liivalaia 22  
10118 Tallinn, Estonia  
Phone: +372 640 3109  
Fax: +372 640 3105  
E-mail: olga@turvaja.ee  
Http://www.turvaja.ee  
English, Russian, Estonian
- Tarmo ROSMAN**      **Rosman and Partners Ltd.**  
P.O. Box 652  
12602 Tallinn, Estonia  
Phone: +372 656 1450  
Fax: +372 656 1450  
E-mail: tarman@cc.ttu.ee  
German, English, Hungarian,  
Russian, Estonian
- Enn URGAS**      **Patendibüroo TURVAJA OÜ**  
Liivalaia 22  
10118 Tallinn, Estonia  
Phone: +372 640 3109  
Fax: +372 640 3105  
E-mail: urgas@turvaja.ee  
Http://www.turvaja.ee  
English, Russian, Estonian
- Arvo SALUMÄE**      **AMENDE Patent Agency Ltd.**  
Raua 65, 10152 Tallinn, Estonia  
Phone: +372 648 6125  
Fax: +372 641 0174  
E-mail: amende@hot.ee  
English, German, Finnish,  
Russian, Estonian
- Juta-Maris UUSTALU**      **Lasvet Ltd.**  
P.O. Box 3136  
10505 Tallinn, Estonia  
Phone: +372 640 6600  
Fax: +372 640 6604  
E-mail: lasvet@lasvet.ee  
Http://www.lasvet.ee  
English, Russian, Estonian
- Almar SEHVER**      **AAA Legal Services**  
Tartu Road 16  
10117 Tallinn, Estonia  
P.O. Box 3926  
10509 Tallinn, Estonia  
Phone: +372 660 5910  
+372 660 5911  
Fax: +372 660 5912  
E-mail: aaa@aaa.ee  
Http://www.aaa.ee  
English, Russian,  
Estonian