



ISSN 1406-376X

EESTI VABARIIK

T **EESTI**
TÖÖSTUSDISAINI-
LAHENDUSE LEHT



PATENDIAMETI AMETLIK VÄLJAANNE

2
2007
TALLINN

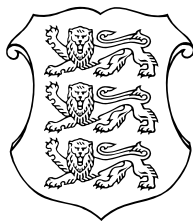

ISSN 1406-376X

EESTI VABARIIK

T **EESTI**
TÖÖSTUSDISAINI-
LAHENDUSE LEHT

**PATENDIAMETI
AMETLIK VÄLJAANNE**

X aastakäik

**Käesolevas numbris
esitatud andmed
loetakse avaldatuks
15. mail 2007. a.**

2
2007
MAI
TALLINN

Eesti Tööstusdisainilahenduse Lehte antakse välja tööstusdisaini kaitse seaduse (jõustunud 11.01.1998) alusel.
The Estonian Industrial Design Gazette is the official publication of the Estonian Patent Office.
Published under Industrial Design Protection Law of the Republic of Estonia (coming into force 11 January 1998).
Date of publication of the data presented in this issue - 15 May 2007.

Patendiameti
infoosakond
Toompuiestee 7
15041 Tallinn
Tel 627 7907
Faks 627 7943
E-post Info@epa.ee

The Information Department
of the Estonian Patent Office
Toompuiestee 7
15041 Tallinn, ESTONIA
Phone +372 627 7907
Fax +372 627 7943
E-mail Info@epa.ee

Levitaja

Eesti Patendiraamatukogu
Olevimägi 8/10
10123 Tallinn
Tel 641 1248
Faks 641 1018
E-post patent@patentlib.ee

Distributor

Estonian Patent Library
Olevimägi 8/10
10123 Tallinn, ESTONIA
Phone +372 641 1248
Fax +372 641 1018
E-mail patent@patentlib.ee

SISUKORD

Andmete identifitseerimise rahvusvahelised numberkoodid (INID-koodid)	4
Riikide, teiste ühenduste ja valitsustevaheliste organisatsioonide koodid	5
I. REGISTREERITUD TÖÖSTUSDISAINILAHENDUSED	6
II. RAHVUSVAHELISELT REGISTREERITUD TÖÖSTUSDISAINILAHENDUSED	55
III. REGISTREERINGU KEHTIVUSE PIKENDAMINE	69
IV. TÖÖSTUSDISAINILAHENDUSE ÜLEMINEK	-
V. REGISTREERINGU JAGAMINE	-
VI. MUUD REGISTREERINGU ANDMETE MUUDATUSED	69
VII. REGISTREERINGU ANDMETE PARANDUSED	69
VIII. TÖÖSTUSDISAINILAHENDUSE LITSENTSIDE REGISTREERIMINE	-
IX. TÖÖSTUSDISAINILAHENDUSE PANTIDE REGISTREERIMINE	-
X. TUNNISTUSE DUPLIKAADI VÄLJAANDMINE	-
XI. TÖÖSTUSDISAINILAHENDUSE KUSTUTAMINE REGISTRIST	70
XII. LOENDID	71
Registreeritud tööstusdisainilahenduste süstemaatiline loend	71
Registreeritud tööstusdisainilahenduste registreerimistaotluste numbriline loend	71
Avaldatud rahvusvahelise registreeringu registreerimise otsuse teadete numbriline loend	72
XIII. TÖÖSTUSDISAINIALASED ÕIGUSAKTID JA MUU INFO	73
Riiklikus patendivolinike registris registreeritud patendivolinike nimekiri	73

CONTENTS

Internationally Agreed Numbers for the Identification of Data (INID Codes)	4
List of Codes of States, Other Entities and Intergovernmental Organizations	5
I. REGISTERED INDUSTRIAL DESIGNS	6
II. INTERNATIONALLY REGISTERED INDUSTRIAL DESIGNS	55
III. EXTENSION OF THE REGISTRATION	69
IV. TRANSFER OF INDUSTRIAL DESIGN	-
V. DIVISION OF THE REGISTRATION.	-
VI. OTHER AMENDMENTS TO REGISTRATION DATA	69
VII. CORRECTIONS TO REGISTRATION DATA	69
VIII. REGISTERING OF LICENSES OF INDUSTRIAL DESIGN	-
IX. REGISTERING OF PLEDGES OF INDUSTRIAL DESIGN	-
X. ISSUE OF A COPY OF THE INDUSTRIAL DESIGN CERTIFICATE	-
XI. DELETION OF INDUSTRIAL DESIGN FROM THE REGISTER	70
XII. LISTS	71
Systematic List of Registered Industrial Designs	71
Numerical List of Registration Applications of Registered Industrial Designs	71
Numerical List of Published Notices of Decisions on Registration of the International Registration	72
XIII. LEGAL ACTS AND INFORMATION CONCERNING INDUSTRIAL DESIGNS	73
List of Patent Attorneys, Registered in the Estonian State Register of Patent Attorneys	77

**ANDMETE IDENTIFITSEERIMISE
RAHVUSVAHELISED NUMBERKOODID
(INID-KOODID)
WIPO Standard ST. 80**

**INTERNATIONALLY AGREED NUMBERS FOR
THE IDENTIFICATION OF DATA
(INID CODES)
WIPO Standard ST. 80**

(11) Registreeringu number	(11) Number of the Registration
(15) Registreerimise kuupäev	(15) Date of the Registration
(18) Registreeringu kehtivuse lõppemise kuupäev	(18) Expected expiration date of the registration
(21) Registreerimistaotluse number	(21) Application Number
(22) Registreerimistaotluse esitamise kuupäev	(22) Application Filing Date
(24) Registreeringu kehtivuse alguse kuupäev	(24) Date from which the Industrial Design right has effected
(28) Variantide arv	(28) Number of Industrial Designs included in the application
(30) Prioriteet	(30) Priority
(51) Rahvusvahelise klassifikatsiooni klassi ja alaklassi number	(51) International Classification for Industrial Designs (class and subclass of the Locarno Classification)
(54) Tööstusdisainilahenduse nimetus	(54) Title of the Industrial Design
(55) Tööstusdisainilahenduse reproduktsioon	(55) Reproduction of the Industrial Design
(72) Tööstusdisainilahenduse autor(id)	(72) Author(s) of Industrial Design
(73) Tööstusdisainilahenduse omanik(ud)	(73) Proprietor(s) of Industrial Design
(74) Patendivolinik või ühine esindaja	(74) Patent Attorney or Common Representative

**RIIKIDE, TEISTE ÜHENDUSTE JA VALITSUSTEVAAHELISTE
ORGANISATSIOONIDE KOODID**

AD	Andorra	DZ	Alžeeria	JM	Jamaica	PW	Belau
AE	Araabia	EA	Euraasia	JO	Jordania	PY	Paraguay
	Ühendemiraadid		Patendiorganisat-	JP	Jaapan	QA	Katar
AF	Afganistan		sioon (EAPO)	KE	Kenya	RO	Rumeenia
AG	Antigua ja Barbuda	EC	Ecuador	KG	Kõrgõzstan	RS	Serbia
AI	Anguilla	EE	Eesti	KH	Kambodža	RU	Venemaa
AL	Albaania	EG	Egiptus	KI	Kiribati	RW	Rwanda
AM	Armeenia	EH	Lääne-Sahara	KM	Komoorid	SA	Saudi Araabia
AN	Hollandi Antillid	EM	Siseturu	KN	Saint Kitts ja Nevis	SB	Saalomoni Saared
AO	Angola		Ühtlustamise	KP	Põhja-Korea	SC	Seišellid
AP	Aafrika Regionaalne		Amet (kaubamärgid	KR	Lõuna-Korea	SD	Sudaan
	Tööstusomandi Orga-		ja tööstusdisaini-	KW	Kuveit	SE	Rootsi
	nisatsioon (ARIPO)		lahendused) (OHIM)	KY	Kaimanisaared	SG	Singapur
AR	Argentina	EP	Euroopa	KZ	Kasahstan	SH	Saint Helena
AS	Ameerika Samoa		Patendiamet (EPO)	LA	Laos	SI	Sloveenia
AT	Austria	ER	Eritrea	LB	Liibanon	SK	Slovakkia
AU	Austraalia	ES	Hispaania	LC	Saint Lucia	SL	Sierra Leone
AW	Aruba	ET	Etiopia	LI	Liechtenstein	SM	San Marino
AZ	Aserbaidžaan	FI	Soome	LK	Sri Lanka	SN	Senegal
BA	Bosnia ja	FJ	Fidži	LR	Libeeria	SO	Somaalia
	Hertsegoviina	FK	Falklandi (Malviini)	LS	Lesotho	SR	Suriname
BB	Barbados		saared	LT	Leedu	ST	São Tomé ja Príncipe
BD	Bangladesh	FM	Mikroneesia	LU	Luksemburg	SV	El Salvador
BE	Belgia	FO	Fääri saared	LV	Läti	SY	Süüria
BF	Burkina Faso	FR	Prantsusmaa	LY	Liibüa	SZ	Svaasimaa
BG	Bulgaaria	GA	Gabon	MA	Maroko	TC	Turks ja Caicos
BH	Bahrein	GB	Ühendkuningriik	MC	Monaco	TD	Tšaad
BI	Burundi		(Suurbritannia)	MD	Moldova	TG	Togo
BJ	Benin	GC	Pärsia Lahe	ME	Montenegro	TH	Tai
BM	Bermuda		Koostööõnukogu	MG	Madagaskar	TJ	Tadžikistan
BN	Brunei	GD	Grenada	MH	Marshalli Saared	TM	Türkmenistan
BO	Boliivia	GE	Gruusia	MK	Makedoonia	TN	Tuneesia
BR	Brasiilia	GG	Guernsey	ML	Mali	TO	Tonga
BS	Bahama	GH	Ghana	MM	Myanmar (Birma)	TL	Ida-Timor
BT	Bhutan	GI	Gibraltar	MN	Mongoolia	TR	Türgi
BV	Bouvet' saar	GL	Gröönimaa	MO	Macao	TT	Trinidad ja Tobago
BW	Botswana	GM	Gambia	MP	Põhja-Mariaanid	TV	Tuvalu
BX	Beneluxi	GN	Guinea	MR	Mauritaania	TW	Taiwan (Hiina provints)
	Kaubamärgiamet	GQ	Ekvatoriaal-Guinea	MS	Montserrat	TZ	Tansaania
	(BBM) ja Beneluxi	GR	Kreeka	MT	Malta	UA	Ukraina
	Tööstusdisainilahen-	GS	Lõuna-Georgia ja	MU	Mauritius	UG	Uganda
	duste Amet (BBDM)		Lõuna-Sandwichi	MV	Maldiivid	US	Ameerika
BY	Valgevene		saared	MW	Malawi		Ühendriigid
BZ	Belize	GT	Guatemala	MX	Mehhiko	UY	Uruguay
CA	Kanada	GW	Guinea-Bissau	MY	Malaisia	UZ	Usbekistan
CF	Kesk-Aafrika	GY	Guyana	MZ	Mosambiik	VA	Vatikan (Püha Tool)
	Vabariik	HK	Hongkong	NA	Namiibia	VC	Saint Vincent ja
CG	Kongo	HN	Honduras	NE	Niger		Grenadiinid
CH	Šveits	HR	Horvaatia	NG	Nigeeria	VE	Venezuela
CI	Côte d'Ivoire	HT	Haiti	NI	Nicaragua	VG	Neitsisaared
CK	Cooki saared	HU	Ungari	NL	Holland	VN	Vietnam
CL	Tšiili	IB	Ülemaailmse	NO	Norra	VU	Vanuatu
CM	Kamerun		Intellektuaalomandi	NP	Nepal	WO	Ülemaailmne
CN	Hiina		Organisatsiooni	NR	Nauru		Intellektuaalomandi
CO	Kolumbia		(WIPO) Rahvus-	NZ	Uus-Meremaa		Organisatsioon
CR	Costa Rica		vaheline Büroo	OA	Aafrika Intellektuaal-		(WIPO) (Rahvus-
CU	Kuuba	ID	Indoneesia		omandi Organisat-		vaheline Büroo)
CV	Cabo Verde	IE	Iiri		sioon (OAPI)	WS	Samoa
CY	Küpros	IL	Iisrael	OM	Omaan	YE	Jeemen
CZ	Tšehhi	IM	Man'i saar	PA	Panama	ZA	Lõuna-Aafrika Vabariik
DE	Saksamaa	IN	India	PE	Peruu	ZM	Sambia
DJ	Djibouti	IQ	Iraak	PG	Paapua Uus-Guinea	ZR	Zaire
DK	Taani	IR	Iraan	PH	Filipiinid	ZW	Zimbabwe
DM	Dominica	IS	Island	PK	Pakistan		
DO	Dominikaani	IT	Itaalia	PL	Poola		
	Vabariik	JE	Jersey	PT	Portugal		

I. REGISTREERITUD TÖÖSTUSDISAINILAHENDUSED

Avaldatakse "Tööstusdisaini kaitse seaduse" § 55¹ lõike 7 alusel.

Patendiamet ei ole kontrollinud tööstusdisainilahenduse uudsust ja eristatavust tulenevalt "Tööstusdisaini kaitse seaduse" § 31 lõike 2 punktist 1.

(11) Registreeringu number	01269	(51) Klass: 11-02
(21) Taotluse number	D200600042	
(15) Registreerimise päev	15.05.2007	
(22) Esitamise päev	19.06.2006	
(24) Registreeringu kehtivuse alguse päev	19.06.2006	
(18) Registreeringu kehtivuse lõppemise päev	19.06.2011	
(28) Variantide arv	5	
(72) Autor	Tamara Pekarskaja, Kivila 34-172, 13814 Tallinn, EE	
(73) Omanik	Tamara Pekarskaja, Kivila 34-172, 13814 Tallinn, EE	

(54) Nimetus **Keraamiline nukk**

(55) Reproduktsoon

01269-01



01269-02



01269-03



01269-04



01269-05



- (11) **Registreeringu number** **01270** (51) Klass: **06-01**
- (21) **Taotluse number** D200600063
- (15) **Registreerimise päev** 15.05.2007
- (22) **Esitamise päev** 18.08.2006
- (24) **Registreeringu kehtivuse alguse päev** 18.08.2006
- (18) **Registreeringu kehtivuse lõppemise päev** 18.08.2011
- (28) **Variantide arv** 1
- (72) **Autor** Aavo Ermel, Kolga 68-13, Kolga, 74602 Harju maakond, Kuusalu vald, EE
- (73) **Omanik** Tallinna Linnakantselei, Vabaduse väljak 7, 10141 Tallinn, EE
- (74) **Patendivolinik või ühine esindaja** Reet Maasikamäe

(54) **Nimetus** **Istepink**

(55) **Reproduktsoon**

01270-01

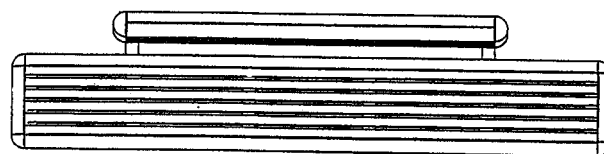
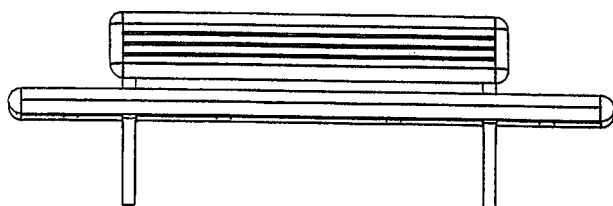

(11) Registreeringu number	01271	(51) Klass: 09-09
(21) Taotluse number	D200600063A	
(15) Registreerimise päev	15.05.2007	
(22) Esitamise päev	18.08.2006	
(24) Registreeringu kehtivuse alguse päev	18.08.2006	
(18) Registreeringu kehtivuse lõppemise päev	18.08.2011	
(28) Variantide arv	1	
(72) Autor	Aavo Ermel, Kolga 68-13, Kolga, 74602 Harju maakond, Kuusalu vald, EE	
(73) Omanik	Tallinna Linnakantsleil, Vabaduse väljak 7, 10141 Tallinn, EE	
(74) Patendivolinik või ühine esindaja	Reet Maasikamäe	

(54) Nimetus **Prügikast**

(55) Reproduktsoon

01271-01

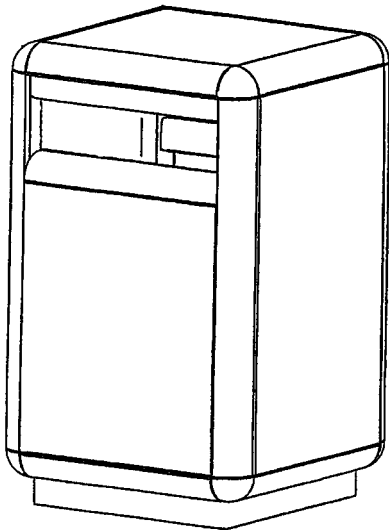

(11) Registreeringu number	01272	(51) Klass: 20-02
(21) Taotluse number	D200600063B	
(15) Registreerimise päev	15.05.2007	
(22) Esitamise päev	18.08.2006	
(24) Registreeringu kehtivuse alguse päev	18.08.2006	
(18) Registreeringu kehtivuse lõppemise päev	18.08.2011	
(28) Variantide arv	1	
(72) Autor	Aavo Ermel, Kolga 68-13, Kolga, 74602 Harju maakond, Kuusalu vald, EE	
(73) Omanik	Tallinna Linnakantselei, Vabaduse väljak 7, 10141 Tallinn, EE	
(74) Patendivolinik või ühine esindaja	Reet Maasikamäe	

(54) Nimetus **Infostend**

(55) Reproduktsoon

01272-01

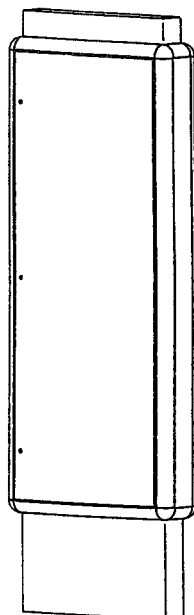

(11) Registreeringu number	01273	(51) Klass: 25-01, 25-02
(21) Taotluse number	D200600063C	
(15) Registreerimise päev	15.05.2007	
(22) Esitamise päev	18.08.2006	
(24) Registreeringu kehtivuse alguse päev	18.08.2006	
(18) Registreeringu kehtivuse lõppemise päev	18.08.2011	
(28) Variantide arv	1	
(72) Autor	Aavo Ermel, Kolga 68-13, Kolga, 74602 Harju maakond, Kuusalu vald, EE	
(73) Omanik	Tallinna Linnakantselei, Vabaduse väljak 7, 10141 Tallinn, EE	
(74) Patendivolinik või ühine esindaja	Reet Maasikamäe	

(54) Nimetus **Tänavapiire**

(55) Reproduktsoon

01273-01

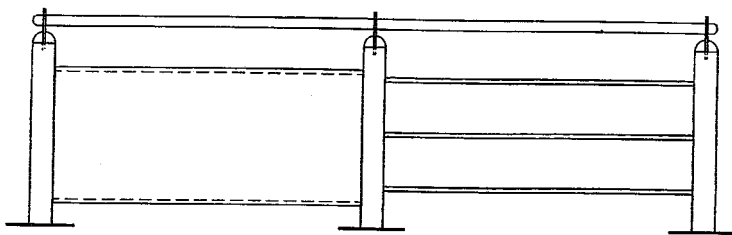
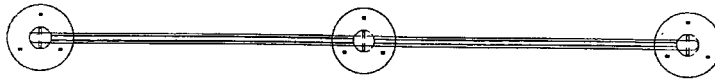

- (11) **Registreeringu number** **01274**
- (21) **Taotluse number** D200600063D
- (15) **Registreerimise päev** 15.05.2007
- (22) **Esitamise päev** 18.08.2006
- (24) **Registreeringu kehtivuse alguse päev** 18.08.2006
- (18) **Registreeringu kehtivuse lõppemise päev** 18.08.2011
- (28) **Variantide arv** 1
- (72) **Autor** Aavo Ermel, Kolga 68-13, Kolga, 74602 Harju maakond, Kuusalu vald, EE
- (73) **Omanik** Tallinna Linnakantselei, Vabaduse väljak 7, 10141 Tallinn, EE
- (74) **Patendivolinik või ühine esindaja** Reet Maasikamäe

(51) Klass: **20-03**

(54) **Nimetus** **Välireklaamikandja**

(55) **Reproduktsoon**

01274-01

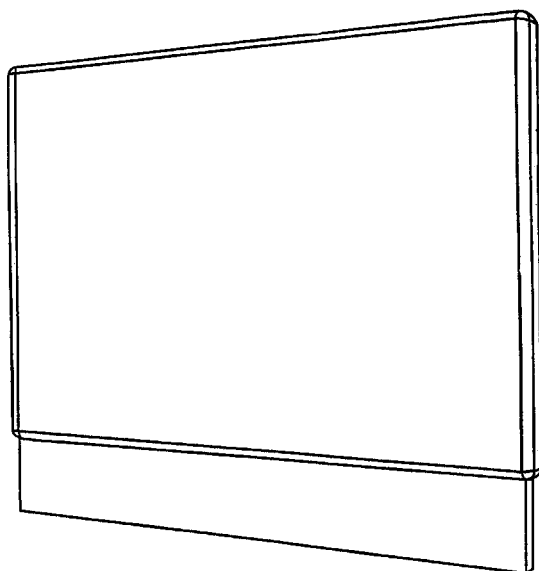

- (11) **Registreeringu number** **01275** (51) Klass: **25-03**
- (21) **Taotluse number** D200600063E
- (15) **Registreerimise päev** 15.05.2007
- (22) **Esitamise päev** 18.08.2006
- (24) **Registreeringu kehtivuse alguse päev** 18.08.2006
- (18) **Registreeringu kehtivuse lõppemise päev** 18.08.2011
- (28) **Variantide arv** 1
- (72) **Autor** Aavo Ermel, Kolga 68-13, Kolga, 74602 Harju maakond, Kuusalu vald, EE
- (73) **Omanik** Tallinna Linnakantselei, Vabaduse väljak 7, 10141 Tallinn, EE
- (74) **Patendivolinik või ühine esindaja** Reet Maasikamäe
- (54) **Nimetus** **Ühistranspordi ootepaviljon**
- (55) **Reproduktsoon**

01275-01

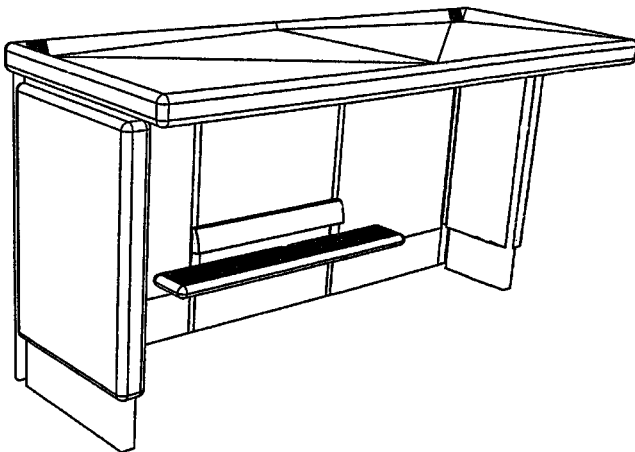

- (11) **Registreeringu number** **01276** (51) Klass: **23-02, 25-03**
- (21) **Taotluse number** D200600063F
- (15) **Registreerimise päev** 15.05.2007
- (22) **Esitamise päev** 18.08.2006
- (24) **Registreeringu kehtivuse alguse päev** 18.08.2006
- (18) **Registreeringu kehtivuse lõppemise päev** 18.08.2011
- (28) **Variantide arv** 1
- (72) **Autor** Aavo Ermel, Kolga 68-13, Kolga, 74602 Harju maakond, Kuusalu vald, EE
- (73) **Omanik** Tallinna Linnakantsleil, Vabaduse väljak 7, 10141 Tallinn, EE
- (74) **Patendivolinik või ühine esindaja** Reet Maasikamäe

(54) **Nimetus** **Välikäimla**

(55) **Reproduktsoon**

01276-01

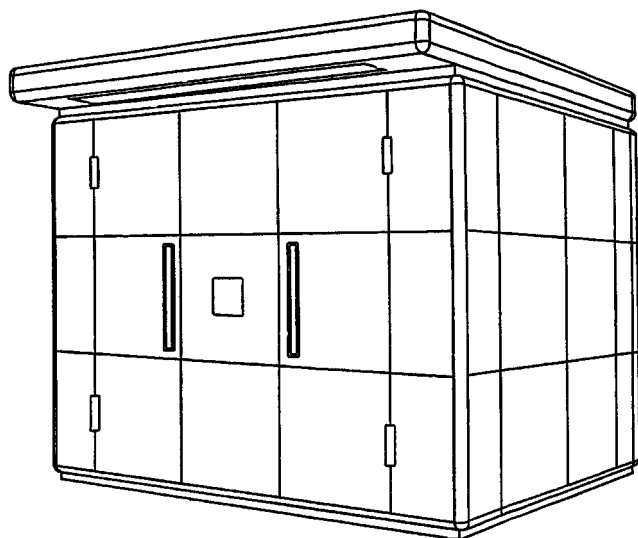

(11) Registreeringu number	01277	(51) Klass: 26-03
(21) Taotluse number	D200600063G	
(15) Registreerimise päev	15.05.2007	
(22) Esitamise päev	18.08.2006	
(24) Registreeringu kehtivuse alguse päev	18.08.2006	
(18) Registreeringu kehtivuse lõppemise päev	18.08.2011	
(28) Variantide arv	1	
(72) Autor	Aavo Ermel, Kolga 68-13, Kolga, 74602 Harju maakond, Kuusalu vald, EE	
(73) Omanik	Tallinna Linnakantselei, Vabaduse väljak 7, 10141 Tallinn, EE	
(74) Patendivolinik või ühine esindaja	Reet Maasikamäe	

(54) **Nimetus** **Tänavavalgustuspost**

(55) **Reproduktsoon**

01277-01

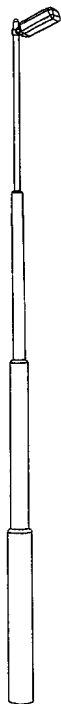

(11) Registreeringu number	01278	(51) Klass: 20-03
(21) Taotluse number	D200600063H	
(15) Registreerimise päev	15.05.2007	
(22) Esitamise päev	18.08.2006	
(24) Registreeringu kehtivuse alguse päev	18.08.2006	
(18) Registreeringu kehtivuse lõppemise päev	18.08.2011	
(28) Variantide arv	1	
(72) Autor	Aavo Ermel, Kolga 68-13, Kolga, 74602 Harju maakond, Kuusalu vald, EE	
(73) Omanik	Tallinna Linnakantselei, Vabaduse väljak 7, 10141 Tallinn, EE	
(74) Patendivolinik või ühine esindaja	Reet Maasikamäe	

(54) Nimetus **Suunaviidad**

(55) Reproduktsoon

01278-01

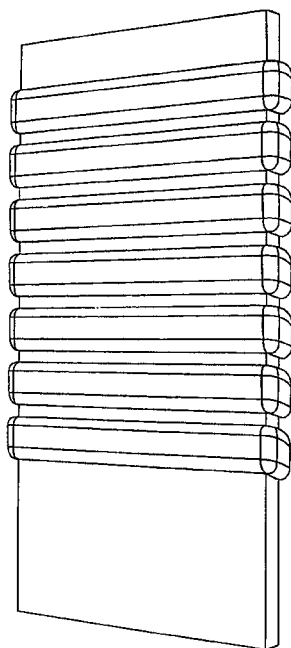

(11) Registreeringu number	01279	(51) Klass: 20-03
(21) Taotluse number	D200600063I	
(15) Registreerimise päev	15.05.2007	
(22) Esitamise päev	18.08.2006	
(24) Registreeringu kehtivuse alguse päev	18.08.2006	
(18) Registreeringu kehtivuse lõppemise päev	18.08.2011	
(28) Variantide arv	1	
(72) Autor	Aavo Ermel, Kolga 68-13, Kolga, 74602 Harju maakond, Kuusalu vald, EE	
(73) Omanik	Tallinna Linnakantslelei, Vabaduse väljak 7, 10141 Tallinn, EE	
(74) Patendivolinik või ühine esindaja	Reet Maasikamäe	

(54) **Nimetus** **Aadressitähis**

(55) **Reproduktsoon**

01279-01

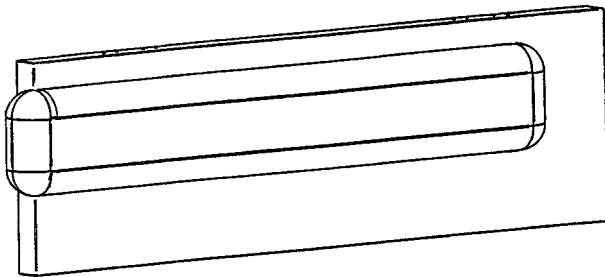

- (11) **Registreeringu number** **01280**
- (21) **Taotluse number** D200600063J
- (15) **Registreerimise päev** 15.05.2007
- (22) **Esitamise päev** 18.08.2006
- (24) **Registreeringu kehtivuse alguse päev** 18.08.2006
- (18) **Registreeringu kehtivuse lõppemise päev** 18.08.2011
- (28) **Variantide arv** 1
- (72) **Autor** Aavo Ermel, Kolga 68-13, Kolga, 74602 Harju maakond, Kuusalu vald, EE
- (73) **Omanik** Tallinna Linnakantselei, Vabaduse väljak 7, 10141 Tallinn, EE
- (74) **Patendivolinik või ühine esindaja** Reet Maasikamäe

(51) Klass: **09-03**

(54) **Nimetus** **Haljastuskonteiner**

(55) **Reproduktsoon**

01280-01

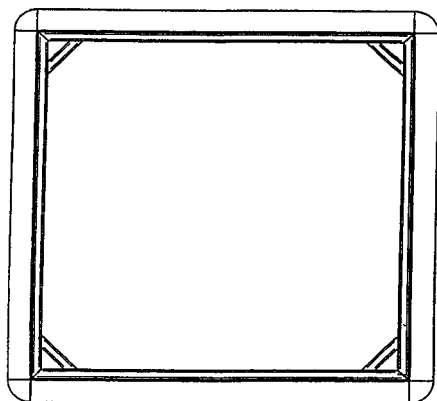
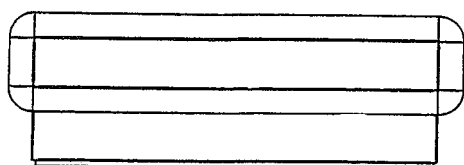

- (11) **Registreeringu number** **01281** (51) Klass: **25-01, 25-02**
- (21) **Taotluse number** D200600063K
- (15) **Registreerimise päev** 15.05.2007
- (22) **Esitamise päev** 18.08.2006
- (24) **Registreeringu kehtivuse alguse päev** 18.08.2006
- (18) **Registreeringu kehtivuse lõppemise päev** 18.08.2011
- (28) **Variantide arv** 1
- (72) **Autor** Aavo Ermel, Kolga 68-13, Kolga, 74602 Harju maakond, Kuusalu vald, EE
- (73) **Omanik** Tallinna Linnakantslelei, Vabaduse väljak 7, 10141 Tallinn, EE
- (74) **Patendivolinik või ühine esindaja** Reet Maasikamäe

(54) **Nimetus** **Kõrghaljastuse piire**

(55) **Reproduktsoon**

01281-01

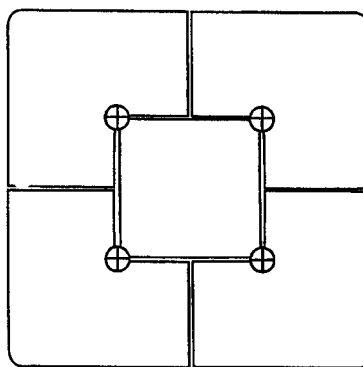
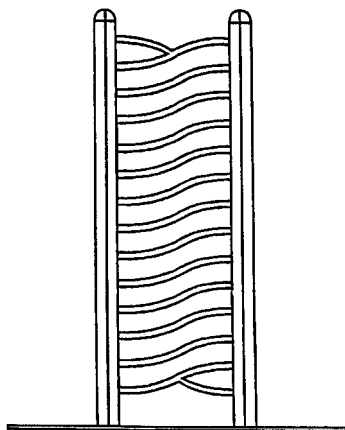

- (11) **Registreeringu number** **01282** (51) Klass: **11-02**
- (21) **Taotluse number** D200600065
- (15) **Registreerimise päev** 15.05.2007
- (22) **Esitamise päev** 23.08.2006
- (24) **Registreeringu kehtivuse alguse päev** 23.08.2006
- (18) **Registreeringu kehtivuse lõppemise päev** 23.08.2011
- (28) **Variantide arv** 2
- (72) **Autor** Jukka Halttunen, Pärnu mnt 24, 10141 Tallinn, EE
Tommi Silvan, Pärnu mnt 24, 10141 Tallinn, EE
- (73) **Omanik** Tommi Silvan, Pärnu mnt 24, 10141 Tallinn, EE
Jukka Halttunen, Pärnu mnt 24, 10141 Tallinn, EE
- (74) **Patendivolinik või ühine esindaja** Mart Enn Koppel
- (54) **Nimetus** **Mosaiikkatte element**
- (55) **Reproduktsoon**

01282-01

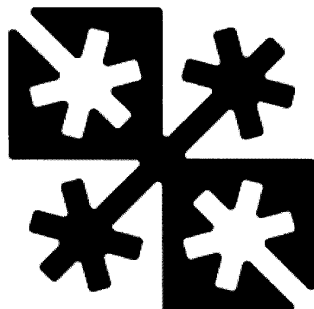

01282-02

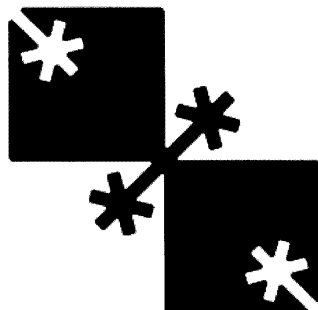

- (11) **Registreeringu number** **01283** (51) Klass: **11-02**
- (21) **Taotluse number** D200600065A
- (15) **Registreerimise päev** 15.05.2007
- (22) **Esitamise päev** 23.08.2006
- (24) **Registreeringu kehtivuse alguse päev** 23.08.2006
- (18) **Registreeringu kehtivuse lõppemise päev** 23.08.2011
- (28) **Variantide arv** 1
- (72) **Autor** Jukka Halttunen, Pärnu mnt 24, 10141 Tallinn, EE
Tommi Silvan, Pärnu mnt 24, 10141 Tallinn, EE
- (73) **Omanik** Tommi Silvan, Pärnu mnt 24, 10141 Tallinn, EE
Jukka Halttunen, Pärnu mnt 24, 10141 Tallinn, EE
- (74) **Patendivolinik või ühine esindaja** Mart Enn Koppel
- (54) **Nimetus** **Mosaiikkatte element**
- (55) **Reproduktsoon**
- 01283-01

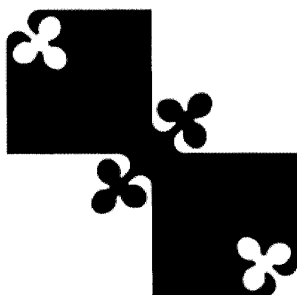

- (11) **Registreeringu number** **01284**
- (21) **Taotluse number** D200600065B
- (15) **Registreerimise päev** 15.05.2007
- (22) **Esitamise päev** 23.08.2006
- (24) **Registreeringu kehtivuse alguse päev** 23.08.2006
- (18) **Registreeringu kehtivuse lõppemise päev** 23.08.2011
- (28) **Variantide arv** 1
- (72) **Autor** Jukka Halttunen, Pärnu mnt 24, 10141 Tallinn, EE
Tommi Silvan, Pärnu mnt 24, 10141 Tallinn, EE
- (73) **Omanik** Tommi Silvan, Pärnu mnt 24, 10141 Tallinn, EE
Jukka Halttunen, Pärnu mnt 24, 10141 Tallinn, EE
- (74) **Patendivolinik või ühine esindaja** Mart Enn Koppel
- (54) **Nimetus** **Mosaiikkatte element**
- (55) **Reproduktsoon**
- 01284-01

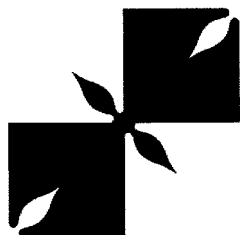

- (11) **Registreeringu number** **01285** (51) Klass: **06-11, 06-12, 11-02**
- (21) **Taotluse number** D200600066
- (15) **Registreerimise päev** 15.05.2007
- (22) **Esitamise päev** 23.08.2006
- (24) **Registreeringu kehtivuse alguse päev** 23.08.2006
- (18) **Registreeringu kehtivuse lõppemise päev** 23.08.2011
- (28) **Variantide arv** 2
- (72) **Autor** Jukka Halttunen, Pärnu mnt 24, 10141 Tallinn, EE
Tommi Silvan, Pärnu mnt 24, 10141 Tallinn, EE
- (73) **Omanik** Tommi Silvan, Pärnu mnt 24, 10141 Tallinn, EE
Jukka Halttunen, Pärnu mnt 24, 10141 Tallinn, EE
- (74) **Patendivolinik või ühine esindaja** Mart Enn Koppel
- (54) **Nimetus** **Mosaikvaipkatte elementide komplekt**
- (55) **Reproduktsoon**

01285-01

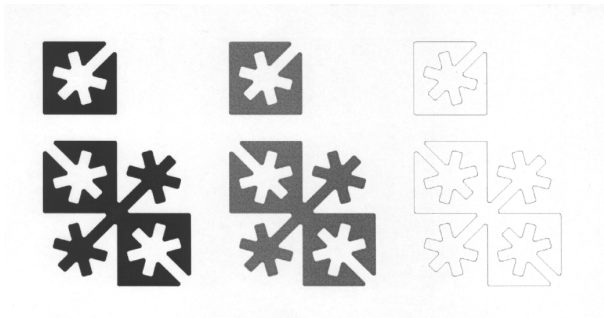

01285-02

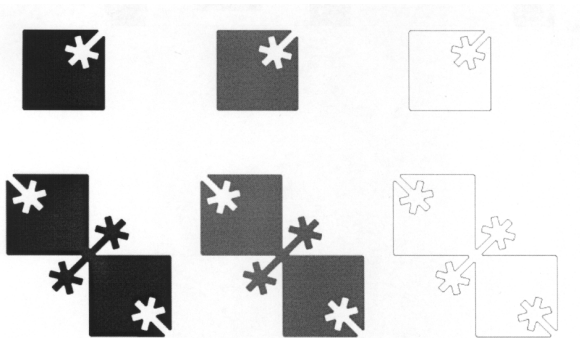

- (11) **Registreeringu number** **01286**
- (21) **Taotluse number** D200600066A
- (15) **Registreerimise päev** 15.05.2007
- (22) **Esitamise päev** 23.08.2006
- (24) **Registreeringu kehtivuse alguse päev** 23.08.2006
- (18) **Registreeringu kehtivuse lõppemise päev** 23.08.2011
- (28) **Variantide arv** 1
- (72) **Autor** Jukka Halttunen, Pärnu mnt 24, 10141 Tallinn, EE
Tommi Silvan, Pärnu mnt 24, 10141 Tallinn, EE
- (73) **Omanik** Tommi Silvan, Pärnu mnt 24, 10141 Tallinn, EE
Jukka Halttunen, Pärnu mnt 24, 10141 Tallinn, EE
- (74) **Patendivolinik või ühine esindaja** Mart Enn Koppel
- (51) **Klass:** **06-11, 06-12, 11-02**
- (54) **Nimetus** **Mosaiikvaipkatte elementide komplekt**
- (55) **Reproduktsoon**

01286-01

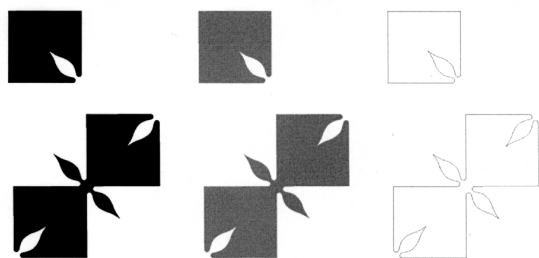

- (11) **Registreeringu number** **01287** (51) Klass: **06-11, 06-12, 11-02**
- (21) **Taotluse number** D200600066B
- (15) **Registreerimise päev** 15.05.2007
- (22) **Esitamise päev** 23.08.2006
- (24) **Registreeringu kehtivuse alguse päev** 23.08.2006
- (18) **Registreeringu kehtivuse lõppemise päev** 23.08.2011
- (28) **Variantide arv** 1
- (72) **Autor** Jukka Halttunen, Pärnu mnt 24, 10141 Tallinn, EE
Tommi Silvan, Pärnu mnt 24, 10141 Tallinn, EE
- (73) **Omanik** Tommi Silvan, Pärnu mnt 24, 10141 Tallinn, EE
Jukka Halttunen, Pärnu mnt 24, 10141 Tallinn, EE
- (74) **Patendivolinik või ühine esindaja** Mart Enn Koppel
- (54) **Nimetus** **Mosaiikvaipkatte elementide komplekt**
- (55) **Reproduktsoon**

01287-01

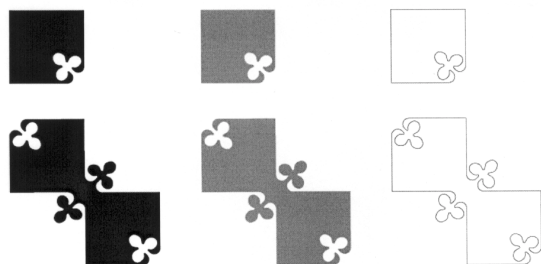

(11) **Registreeringu number** **01288**

(51) Klass: **28-02**

(21) **Taotluse number** D200600103

(15) **Registreerimise päev** 15.05.2007

(22) **Esitamise päev** 16.11.2006

(24) **Registreeringu kehtivuse alguse päev** 16.11.2006

(18) **Registreeringu kehtivuse lõppemise päev** 16.11.2011

(28) **Variantide arv** 2

(72) **Autor** Virve Eviste, Puhkekodu tee 69-1, 12051 Tallinn, EE

(73) **Omanik** Virve Eviste, Puhkekodu tee 69-1, 12015 Tallinn, EE

(74) **Patendivolinik või ühine esindaja** Lembit Mitt

(54) **Nimetus** **Käsitööseep**

(55) **Reproduktsoon**

01288-01



01288-02



(11) **Registreeringu number** **01289**

(51) Klass: **26-01**

(21) **Taotluse number** D200600104

(15) **Registreerimise päev** 15.05.2007

(22) **Esitamise päev** 23.11.2006

(24) **Registreeringu kehtivuse alguse päev** 23.11.2006

(18) **Registreeringu kehtivuse lõppemise päev** 23.11.2011

(28) **Variantide arv** 1

(72) **Autor** Toomas Remmel, Piiri 18-1, 51007 Tartu, EE

(73) **Omanik** Toomas Remmel, Piiri 18-1, 51007 Tartu, EE

(54) **Nimetus** **Küünlajalg**

(55) **Reproduktsoon**

01289-01



- (11) **Registreeringu number** **01290** (51) Klass: **02-06**
- (21) **Taotluse number** D200600105
- (15) **Registreerimise päev** 15.05.2007
- (22) **Esitamise päev** 24.11.2006
- (24) **Registreeringu kehtivuse alguse päev** 24.11.2006
- (18) **Registreeringu kehtivuse lõppemise päev** 24.11.2011
- (28) **Variantide arv** 1
- (72) **Autor** Krista Palder, Pärnu mnt 358-2, 11612 Tallinn, EE
Mari-Liis Poolak, Lõuna 5, 11617 Tallinn, EE
Pille-Riin Vackermann, Vanasilla tee 27, Laagri, 76401 Harju maakond, EE
- (73) **Omanik** Krista Palder, Pärnu mnt 358-2, 11612 Tallinn, EE
Mari-Liis Poolak, Lõuna 5, 11617 Tallinn, EE
Pille-Riin Vackermann, Vanasilla tee 27, Laagri, 76401 Harju maakond, EE
- (54) **Nimetus** **Kinnas**
- (55) **Reproduktsoon**

01290-01



(11) Registreeringu number	01291	(51) Klass: 14-03
(21) Taotluse number	D200600108	
(15) Registreerimise päev	15.05.2007	
(22) Esitamise päev	08.12.2006	
(24) Registreeringu kehtivuse alguse päev	08.12.2006	
(18) Registreeringu kehtivuse lõppemise päev	08.12.2011	
(28) Variantide arv	1	
(30) Prioriteediandmed	29/247302, 09.06.2006, US	
(72) Autor	Andrew Gartrell, 18650 Hatteras St # 206, Tarzana, California 91356, US	
(73) Omanik	Nokia Corporation, Keilalahdentie 4, FIN-02150 Espoo, FI	
(74) Patendivolinik või ühine esindaja	Kalev Käosaar	

(54) Nimetus **Käsitelefoni esipaneel/esiosa**

(55) Reproduktsoon

01291-01

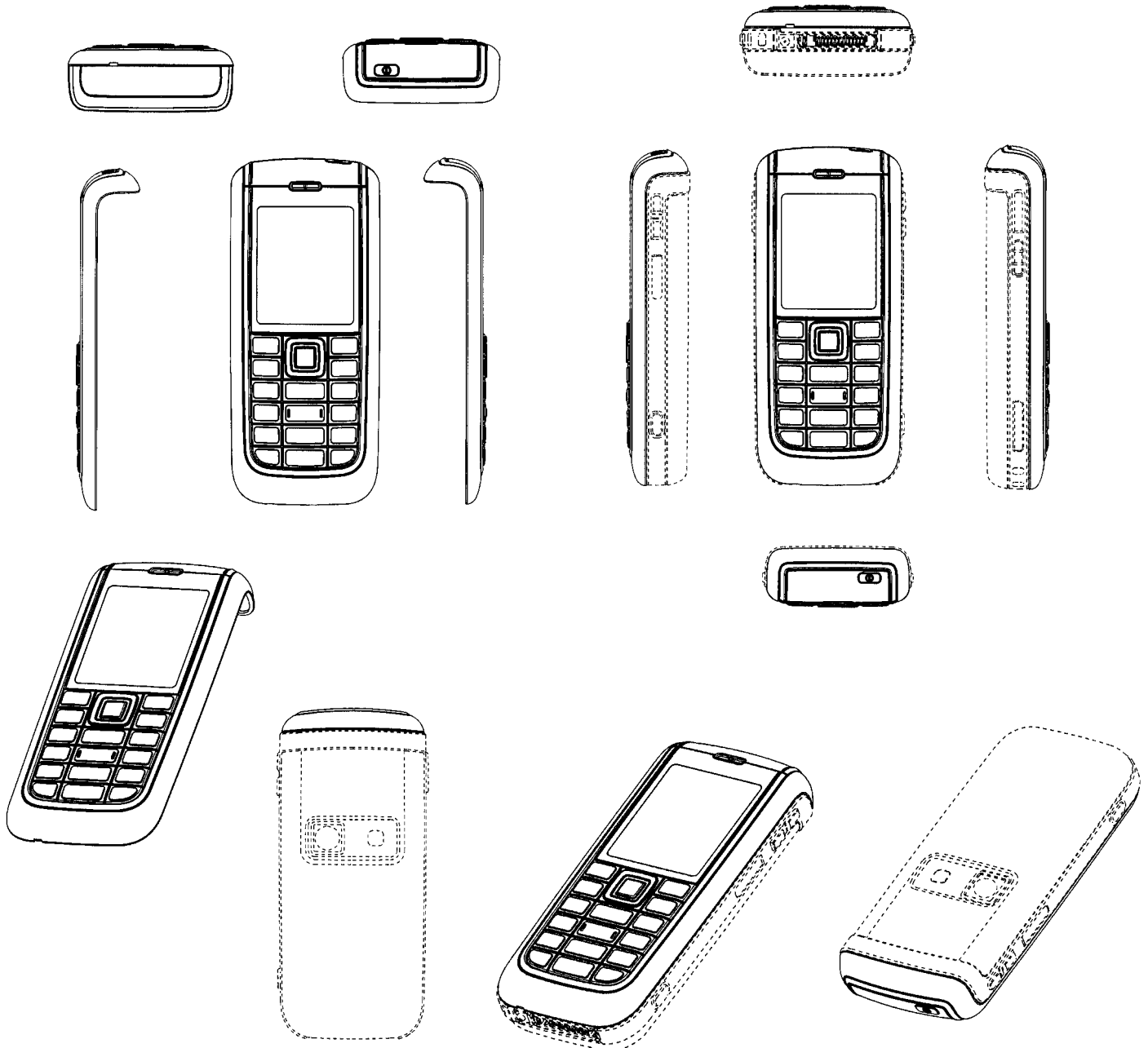

(11) **Registreeringu number** 01292

(51) Klass: 14-03

(21) **Taotluse number** D200600109

(15) **Registreerimise päev** 15.05.2007

(22) **Esitamise päev** 08.12.2006

(24) **Registreeringu kehtivuse alguse päev** 08.12.2006

(18) **Registreeringu kehtivuse lõppemise päev** 08.12.2011

(28) **Variantide arv** 1

(30) **Prioriteediandmed** 29/247302, 09.06.2006, US

(72) **Autor** Andrew Gartrell, 18650 Hatteras St # 206, Tarzana, California 91356, US

(73) **Omanik** Nokia Corporation, Keilalahdentie 4, FIN-02150 Espoo, FI

(74) **Patendivolinik või ühine esindaja** Kalev Käosaar

(54) **Nimetus** Käsitelefon

(55) **Reproduktsoon**

01292-01

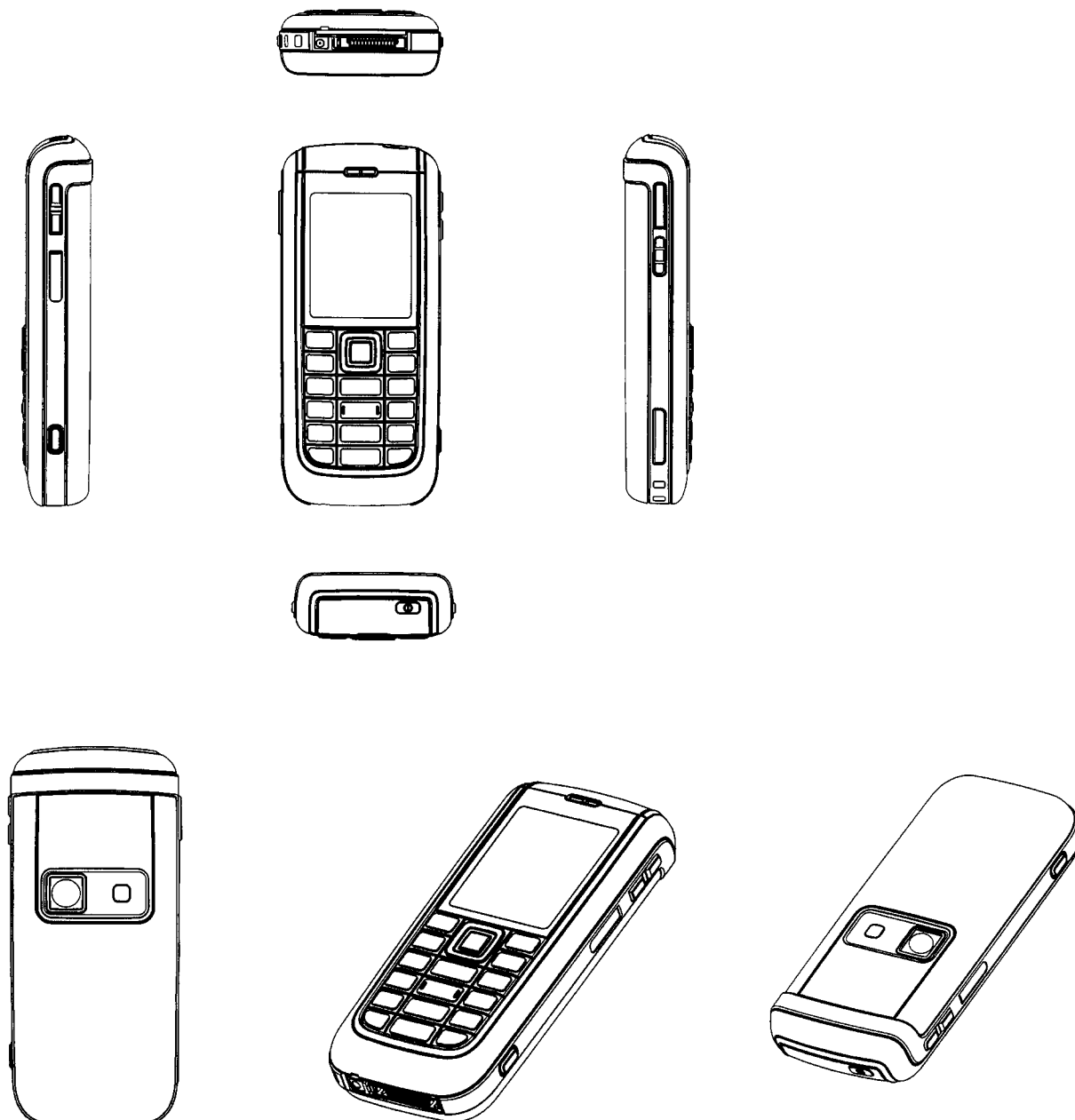

(11) Registreeringu number	01293	(51) Klass: 14-03
(21) Taotluse number	D200600110	
(15) Registreerimise päev	15.05.2007	
(22) Esitamise päev	11.12.2006	
(24) Registreeringu kehtivuse alguse päev	11.12.2006	
(18) Registreeringu kehtivuse lõppemise päev	11.12.2011	
(28) Variantide arv	1	
(30) Prioriteediandmed	M20060144, 24.07.2006, FI	
(72) Autor	Aki Laine, Thørshavnsgade 6, 1th., 2300 København S, DK Christopher Scales, Gl.kalkbraenderivej 25 5.tv, 2100 kbh Ø, DK Pekka Majanen, Jahtikatu 17, 24280 Salo, FI	
(73) Omanik	Nokia Corporation, Keilalahdentie 4, FIN-02150 Espoo, FI	
(74) Patendivolinik või ühine esindaja	Jüri Käosaar	

(54) Nimetus **Käsitelefon**

(55) Reproduktsoon

01293-01

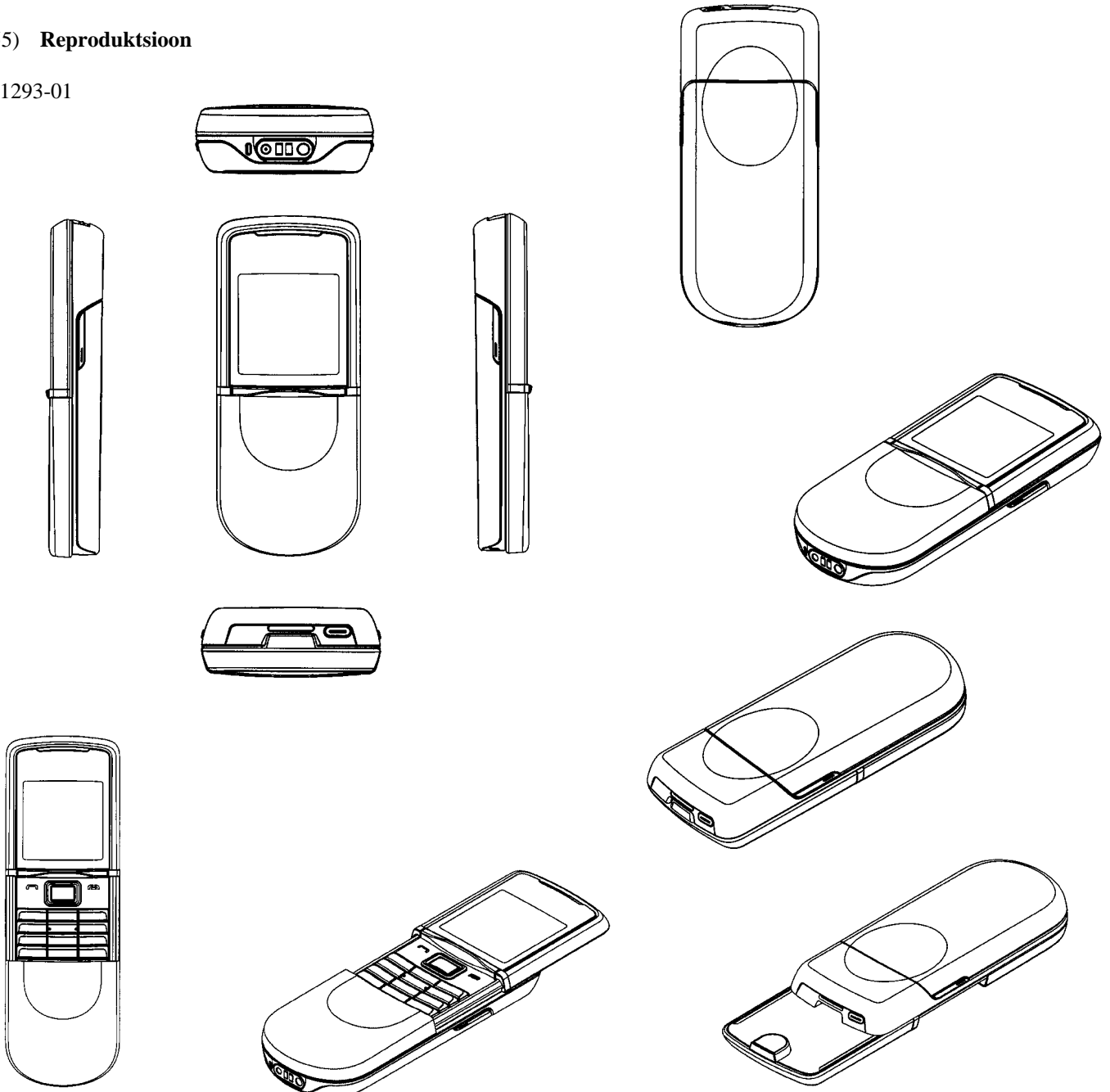

(11) Registreeringu number	01294	(51) Klass: 14-03
(21) Taotluse number	D200600111	
(15) Registreerimise päev	15.05.2007	
(22) Esitamise päev	13.12.2006	
(24) Registreeringu kehtivuse alguse päev	13.12.2006	
(18) Registreeringu kehtivuse lõppemise päev	13.12.2011	
(28) Variantide arv	1	
(30) Prioriteediandmed	M20060130, 14.06.2006, FI	
(72) Autor	Jamie Cobb, 23 top floor flat, Stamford Road, London N1 4JP, GB	
(73) Omanik	Nokia Corporation, Keilalahdentie 4, FIN-02150 Espoo, FI	
(74) Patendivolinik või ühine esindaja	Jüri Käosaar	

(54) Nimetus **Käsitelefon**

(55) Reproduktioon

01294-01

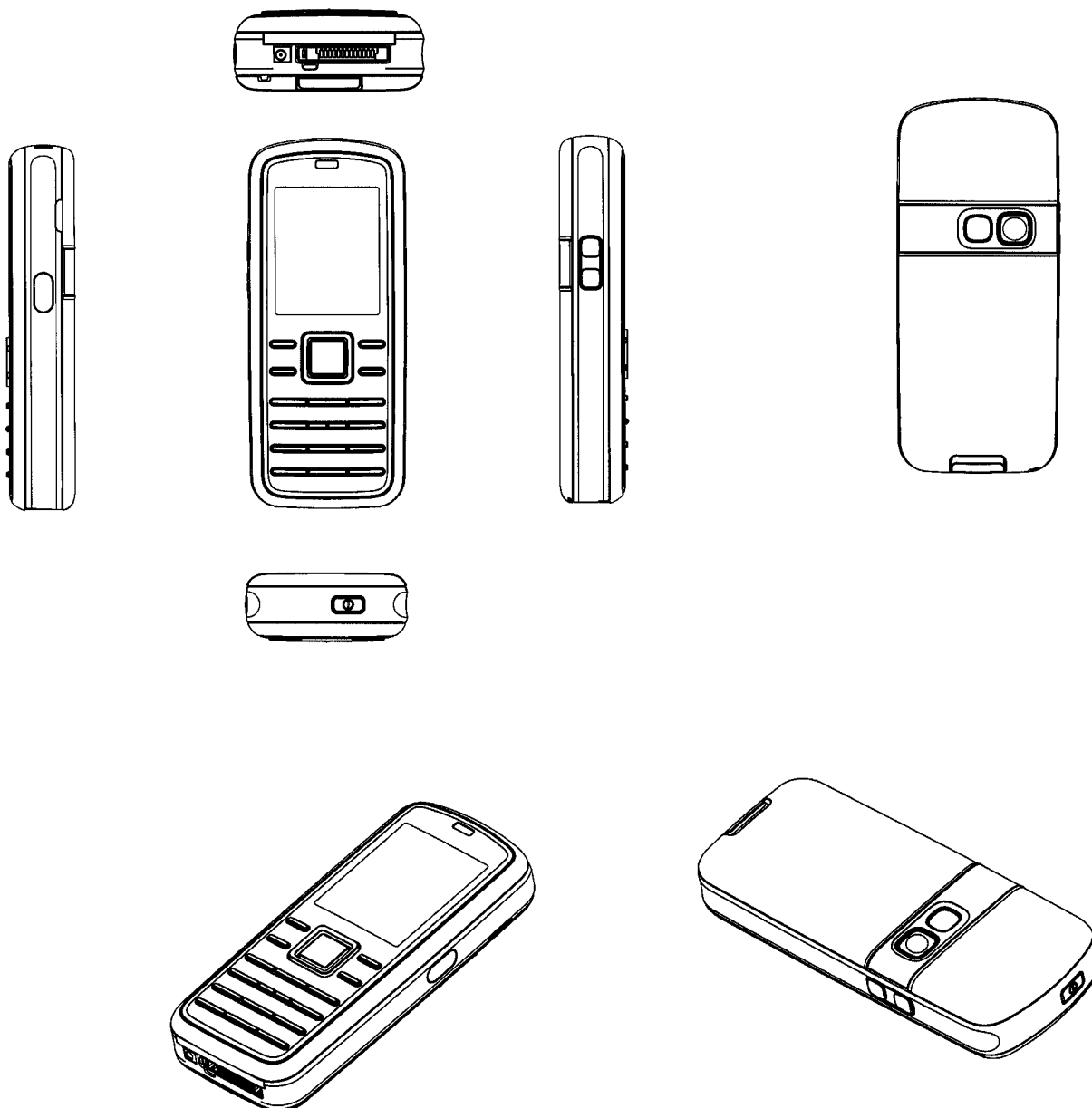

(11) Registreeringu number	01295	(51) Klass: 14-03
(21) Taotluse number	D200600112	
(15) Registreerimise päev	15.05.2007	
(22) Esitamise päev	13.12.2006	
(24) Registreeringu kehtivuse alguse päev	13.12.2006	
(18) Registreeringu kehtivuse lõppemise päev	13.12.2011	
(28) Variantide arv	1	
(30) Prioriteediandmed	M20060130, 14.06.2006, FI	
(72) Autor	Jamie Cobb, 23 top floor flat, Stamford Road, London N1 4JP, GB	
(73) Omanik	Nokia Corporation, Keilalahdentie 4, FIN-02150 Espoo, FI	
(74) Patendivolinik või ühine esindaja	Jüri Käosaar	

(54) Nimetus **Käsitelefoni esipaneel/esiosa**

(55) Reproduktsoon

01295-01

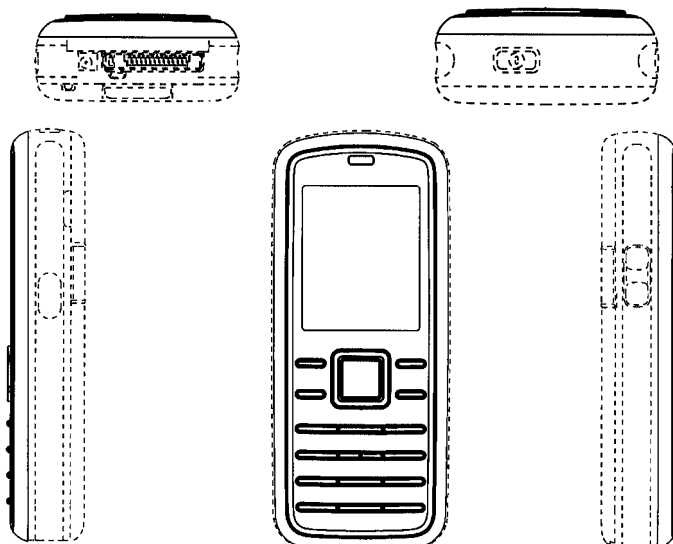
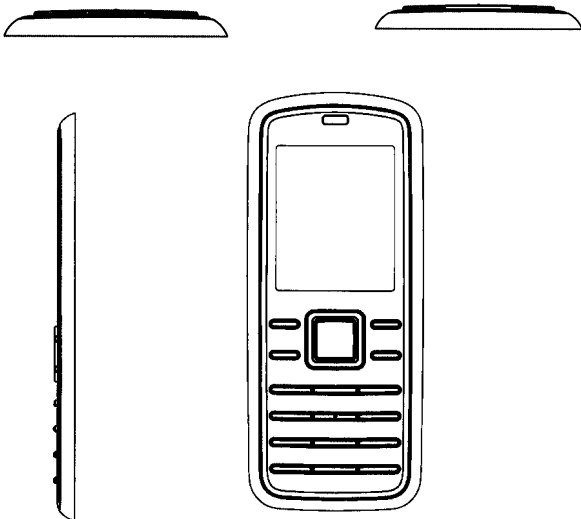

(11) Registreeringu number	01296	(51) Klass: 14-03
(21) Taotluse number	D200700002	
(15) Registreerimise päev	15.05.2007	
(22) Esitamise päev	23.01.2007	
(24) Registreeringu kehtivuse alguse päev	23.01.2007	
(18) Registreeringu kehtivuse lõppemise päev	23.01.2012	
(28) Variantide arv	1	
(30) Prioriteediandmed	M20060143, 24.07.2006, FI	
(72) Autor	Aaron Moss, 33 Queens Road, North Warnborough, Hampshire RG29 1DN, GB	
(73) Omanik	Nokia Corporation, Keilalahdentie 4, FIN-02150 Espoo, FI	
(74) Patendivolinik või ühine esindaja	Kalev Käosaar	

(54) Nimetus **Käsitelefon**

(55) Reproduktsoon

01296-01

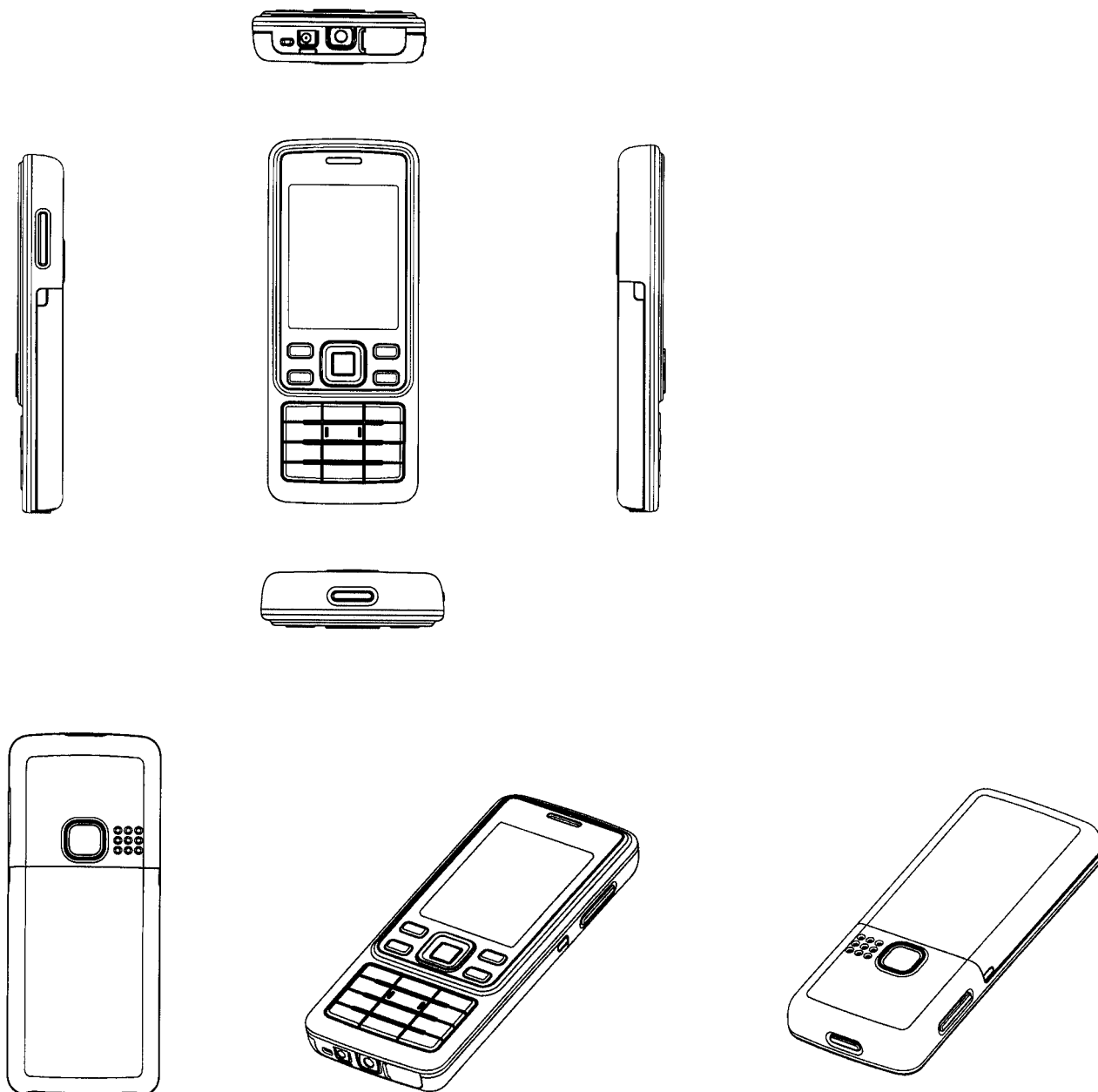

- (11) **Registreeringu number** 01297
- (21) **Taotluse number** D200700003
- (15) **Registreerimise päev** 15.05.2007
- (22) **Esitamise päev** 23.01.2007
- (24) **Registreeringu kehtivuse alguse päev** 23.01.2007
- (18) **Registreeringu kehtivuse lõppemise päev** 23.01.2012
- (28) **Variantide arv** 1
- (30) **Prioriteediandmed** M20060145, 24.07.2006, FI
- (72) **Autor** Christopher Scales, Gl.kalkbraenderivej 25 5.tv, 2100 kbh Ø, DK
Anton Fahlgren, Nordre Frihavnsgade 28, 2100 Copenhagen, DK
- (73) **Omanik** Nokia Corporation, Keilalahdentie 4, FIN-02150 Espoo, FI
- (74) **Patendivolinik või ühine esindaja** Kalev Käosaar

(51) Klass: 14-03

(54) **Nimetus** Käsitelefon(55) **Reproduktsoon**

01297-01

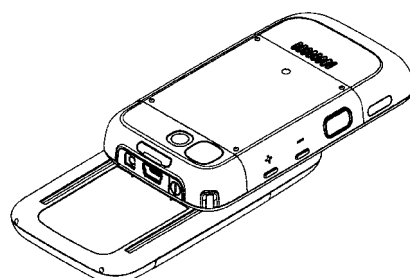
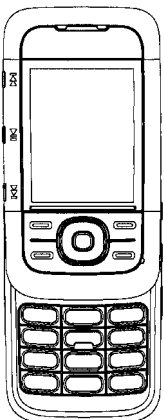
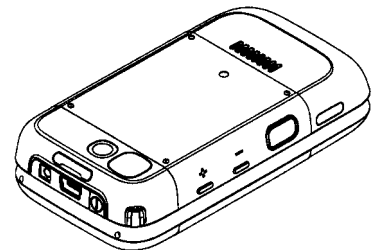
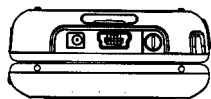
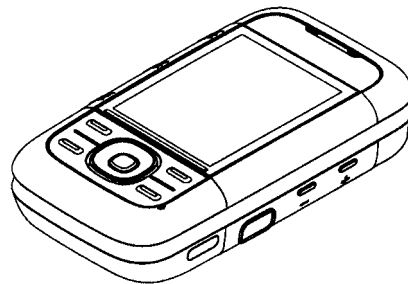
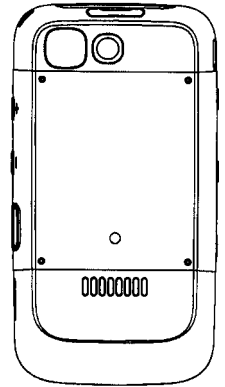
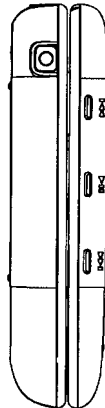
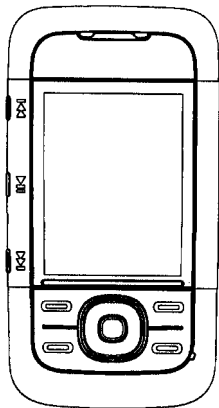
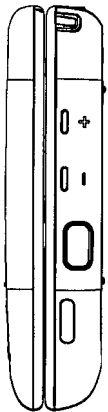

- (11) **Registreeringu number** **01298** (51) Klass: **14-03**
- (21) **Taotluse number** D200700004
- (15) **Registreerimise päev** 15.05.2007
- (22) **Esitamise päev** 23.01.2007
- (24) **Registreeringu kehtivuse alguse päev** 23.01.2007
- (18) **Registreeringu kehtivuse lõppemise päev** 23.01.2012
- (28) **Variantide arv** 1
- (30) **Prioriteediandmed** M20060143, 24.07.2006, FI
- (72) **Autor** Aaron Moss, 33 Queens Road, North Warnborough, Hampshire RG29 1DN, GB
- (73) **Omanik** Nokia Corporation, Keilalahdentie 4, FIN-02150 Espoo, FI
- (74) **Patendivolinik või ühine esindaja** Kalev Käosaar

(54) **Nimetus** **Käsitelefoni esipaneel/esiosa**

(55) **Reproduktsoon**

01298-01

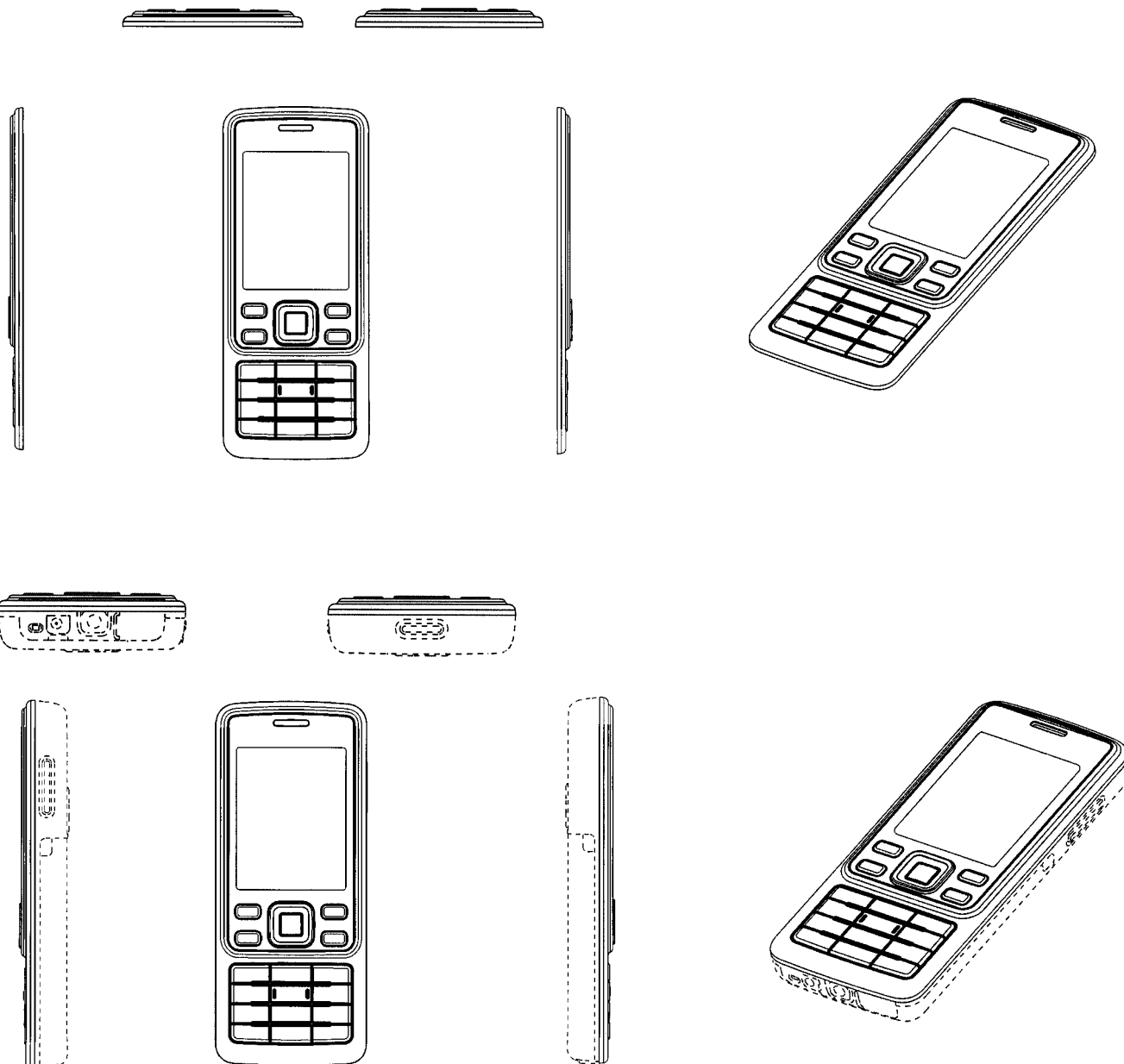

(11) Registreeringu number	01299	(51) Klass: 14-03
(21) Taotluse number	D200700005	
(15) Registreerimise päev	15.05.2007	
(22) Esitamise päev	23.01.2007	
(24) Registreeringu kehtivuse alguse päev	23.01.2007	
(18) Registreeringu kehtivuse lõppemise päev	23.01.2012	
(28) Variantide arv	1	
(30) Prioriteediandmed	M20060145, 24.07.2006, FI	
(72) Autor	Christopher Scales, Gl.kalkbraenderivej 25 5.tv, 2100 kbh Ø, DK Anton Fahlgren, Nordre Frihavnsgade 28, 2100 Copenhagen, DK	
(73) Omanik	Nokia Corporation, Keilalahdentie 4, FIN-02150 Espoo, FI	
(74) Patendivolinik või ühine esindaja	Kalev Käosaar	

(54) Nimetus **Käsitelefon**

(55) Reproduktsoon

01299-01

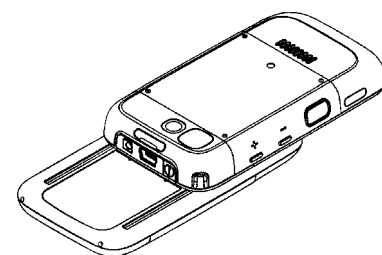
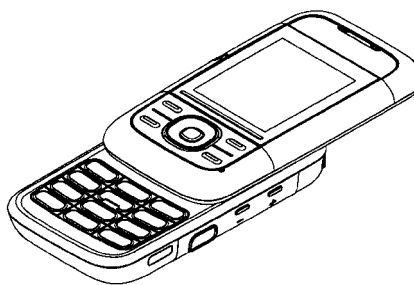
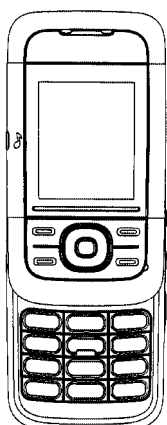
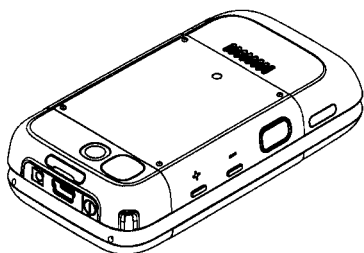
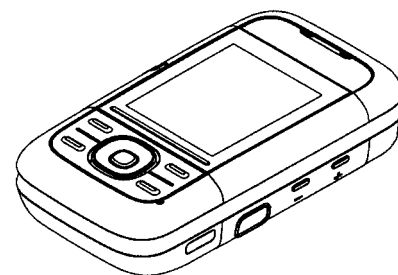
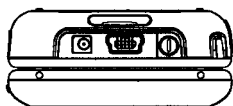
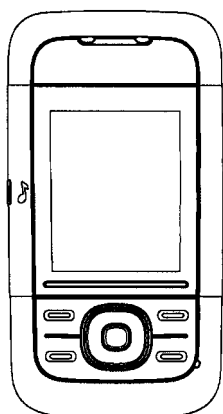
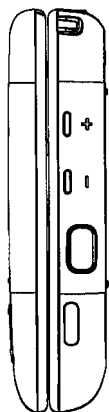
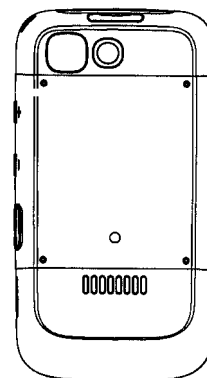

(11) Registreeringu number	01300	(51) Klass: 14-03
(21) Taotluse number	D200700006	
(15) Registreerimise päev	15.05.2007	
(22) Esitamise päev	31.01.2007	
(24) Registreeringu kehtivuse alguse päev	31.01.2007	
(18) Registreeringu kehtivuse lõppemise päev	31.01.2012	
(28) Variantide arv	1	
(30) Prioriteediandmed	M20060153, 18.08.2006, FI	
(72) Autor	Matti Juhani (Jussi) Ruuhonen, Piispankatu 6 D 40-41, FIN-20500 Turku, FI Anthony Dalby, 30, Chandos Avenue, Ealing, London W5 4ER, GB	
(73) Omanik	Nokia Corporation, Keilalahdentie 4, FIN-02150 Espoo, FI	
(74) Patendivolinik või ühine esindaja	Kalev Käosaar	

(54) Nimetus **Käsitelefon**

(55) Reproduktioon

01300-01

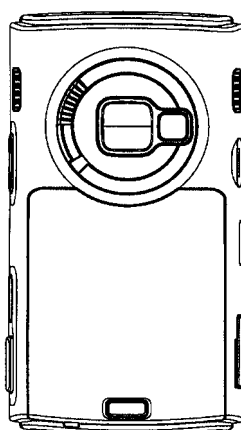
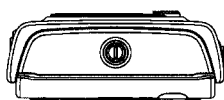
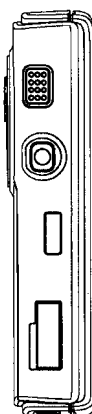
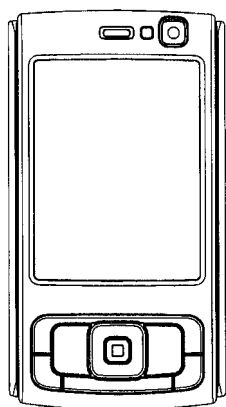
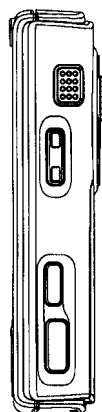
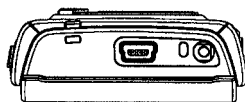

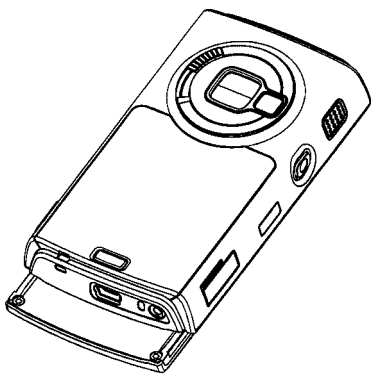
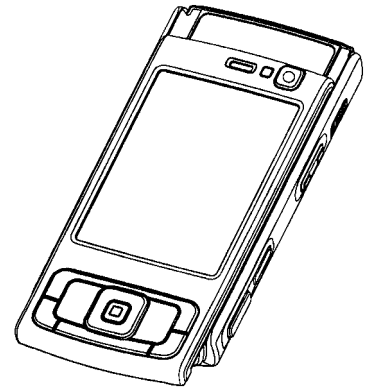
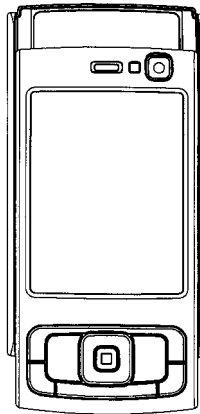
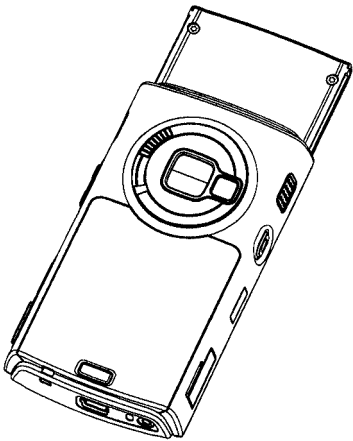
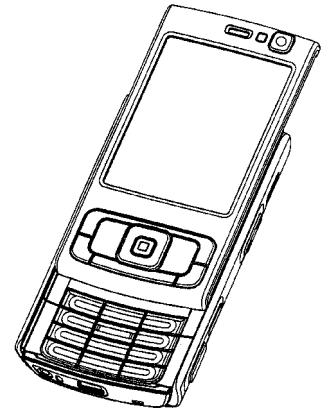
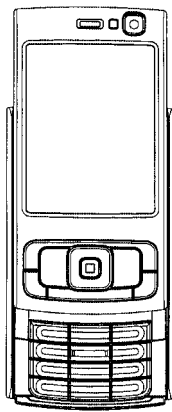
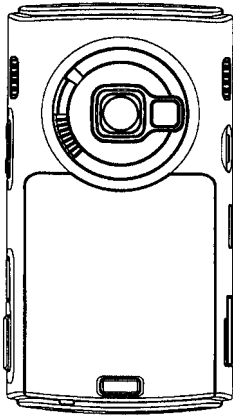

- (11) **Registreeringu number** **01301** (51) Klass: **14-03**
- (21) **Taotluse number** D200700007
- (15) **Registreerimise päev** 15.05.2007
- (22) **Esitamise päev** 31.01.2007
- (24) **Registreeringu kehtivuse alguse päev** 31.01.2007
- (18) **Registreeringu kehtivuse lõppemise päev** 31.01.2012
- (28) **Variantide arv** 1
- (30) **Prioriteediandmed** 29/248,527, 18.08.2006, US
- (72) **Autor** Totti Helin, Köydenpunojankatu 7 B 21, 00180 Helsinki, FI
Dimitre D. Mehandjiysky, 3535 East 1st Street, Belmont Shore, California 90803-2617, US
Tanja Fisher, 40B Strawberry Hill Road, Twickenham, Middlesex TW1 4PU, GB
Tej Chauhan, 109 Beverley Drive, Edgware, Middlesex HA8 5NH, GB
Grace Boicel, 105 a Sheen Lane, SW14 8AE London, GB
Valérie Pegon, 13B Sheen Lane, East Sheen, London SW14 8HY, GB
- (73) **Omanik** Nokia Corporation, Keilalahdentie 4, FIN-02150 Espoo, FI
- (74) **Patendivolinik või ühine esindaja** Kalev Käosaar

(54) **Nimetus** **Käsitelefon**

(55) **Reproduktsoon**

01301-01

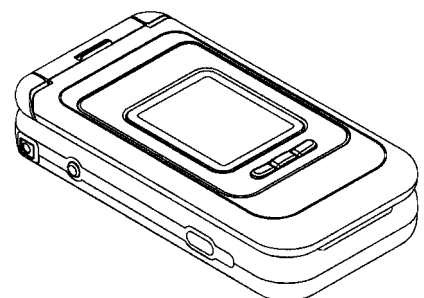
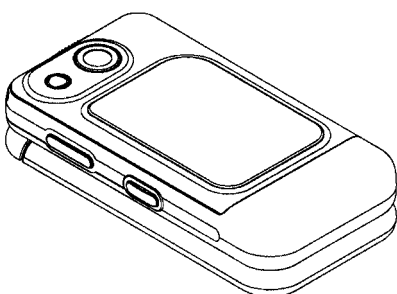
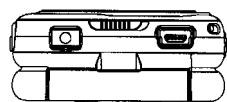
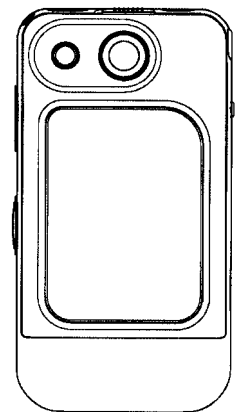
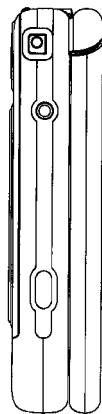
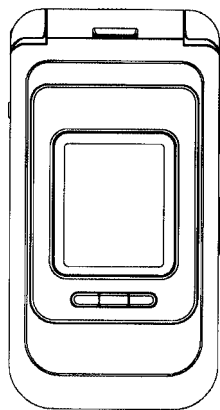
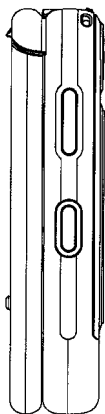

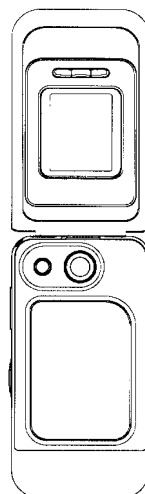
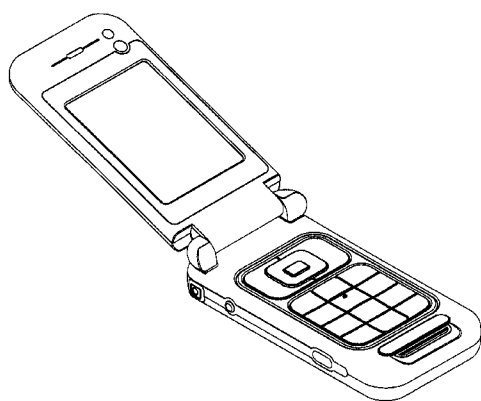
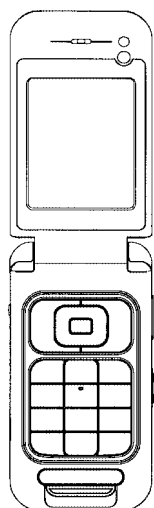

(11) Registreeringu number	01302	(51) Klass: 02-02
(21) Taotluse number	D200700010	
(15) Registreerimise päev	15.05.2007	
(22) Esitamise päev	08.02.2007	
(24) Registreeringu kehtivuse alguse päev	08.02.2007	
(18) Registreeringu kehtivuse lõppemise päev	08.02.2012	
(28) Variantide arv	2	
(72) Autor	Mari Lakspere, Kakumäe tee 257, 13516 Tallinn, EE	
(73) Omanik	Mari Lakspere, Kakumäe tee 257, 13516 Tallinn, EE	

(54) Nimetus **Kampsun**

(55) Reproduktsoon

01302-01

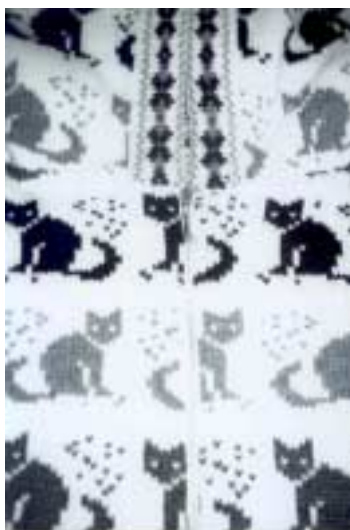

01302-02



(11) Registreeringu number	01303	(51) Klass: 14-03
(21) Taotluse number	D200700011	
(15) Registreerimise päev	15.05.2007	
(22) Esitamise päev	08.02.2007	
(24) Registreeringu kehtivuse alguse päev	08.02.2007	
(18) Registreeringu kehtivuse lõppemise päev	08.02.2012	
(28) Variantide arv	1	
(30) Prioriteediandmed	M20060163, 30.08.2006, FI	
(72) Autor	Shunjiro Eguchi, Otavantie 3 A 25, 00200 Helsinki, FI	
(73) Omanik	Nokia Corporation, Keilalahdentie 4, FIN-02150 Espoo, FI	
(74) Patendivolinik või ühine esindaja	Jüri Käosaar	

(54) Nimetus **Käsitelefon**

(55) Reproduktioon

01303-01

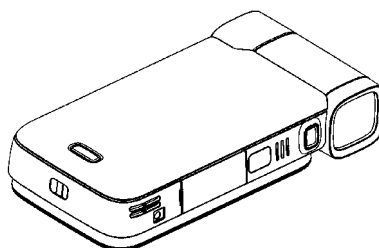
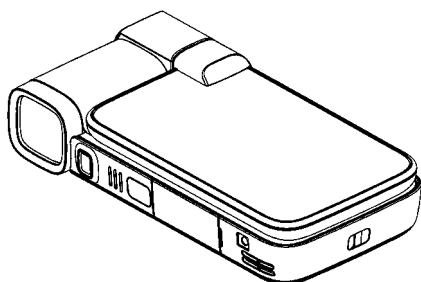
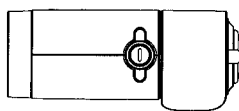
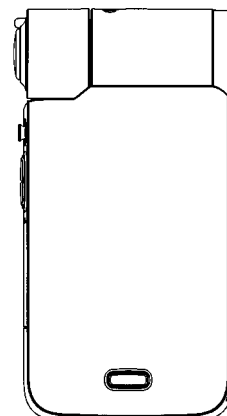
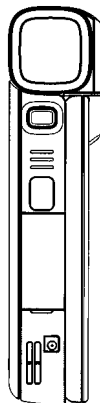
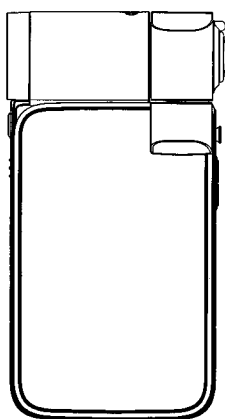
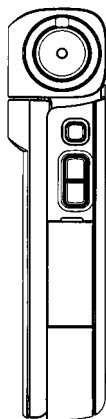
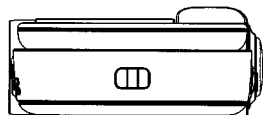

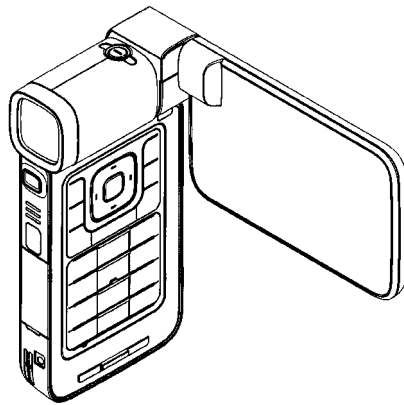
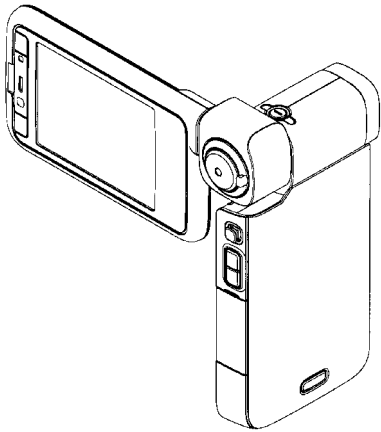
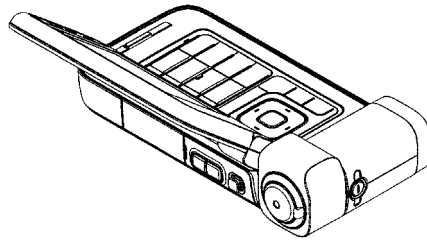
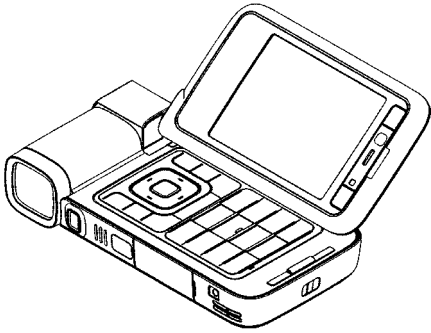
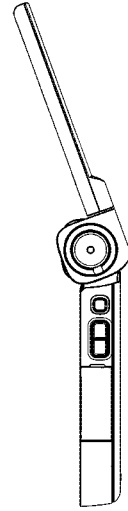
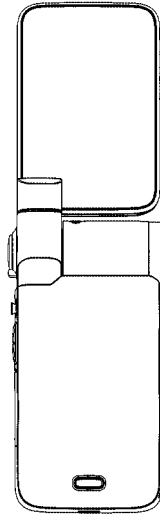
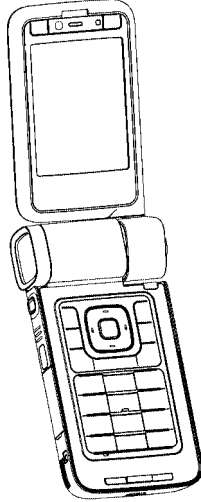
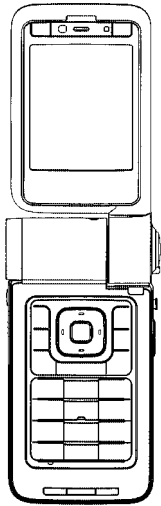

(11) **Registreeringu number** **01304**

(51) **Klass:** 19-04, 19-07, 19-08

(21) **Taotluse number** D200700012

(15) **Registreerimise päev** 15.05.2007

(22) **Esitamise päev** 14.02.2007

(24) **Registreeringu kehtivuse alguse päev** 14.02.2007

(18) **Registreeringu kehtivuse lõppemise päev** 14.02.2012

(28) **Variantide arv** 7

(72) **Autor** Sten Saar, Saare 16, 12011 Tallinn, EE

(73) **Omanik** OÜ REALISTER, Saare 16, 12011 Tallinn, EE

(74) **Patendivolinik või ühine esindaja** Jüri Käosaar

(54) **Nimetus** **Vihikukaas**

(55) **Reproduktsoon**

01304-01



01304-02



01304-03



01304-04



01304-05



01304-06



01304-07



- (11) **Registreeringu number** **01305** (51) Klass: **20-02, 25-03**
- (21) **Taotluse number** D200700013
- (15) **Registreerimise päev** 15.05.2007
- (22) **Esitamise päev** 20.02.2007
- (24) **Registreeringu kehtivuse alguse päev** 20.02.2007
- (18) **Registreeringu kehtivuse lõppemise päev** 20.02.2012
- (28) **Variantide arv** 1
- (72) **Autor** Aavo Ermel, Kolga 68-13, Kolga, 74602 Harju maakond, Kuusalu vald, EE
- (73) **Omanik** Tallinna Linnakantselei, Vabaduse väljak 7, 10141 Tallinn, EE
- (74) **Patendivolinik või ühine esindaja** Reet Maasikamäe

(54) **Nimetus** **Tänavakiosk**

(55) **Reproduktsoon**

01305-01

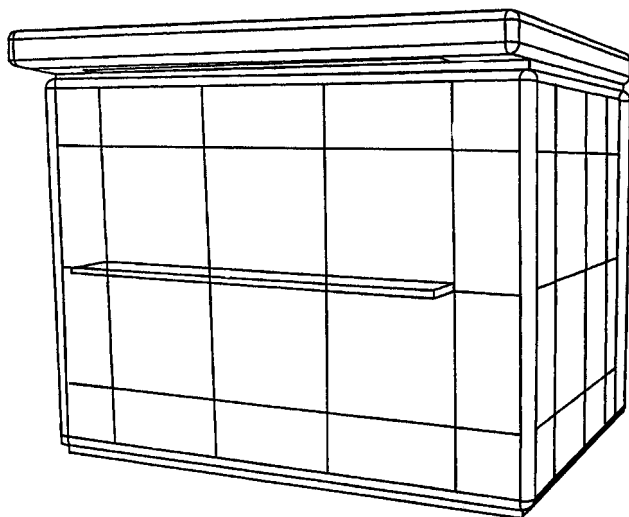

- (11) **Registreeringu number** **01306**
- (21) **Taotluse number** D200700014
- (15) **Registreerimise päev** 15.05.2007
- (22) **Esitamise päev** 09.03.2007
- (24) **Registreeringu kehtivuse alguse päev** 09.03.2007
- (18) **Registreeringu kehtivuse lõppemise päev** 09.03.2012
- (28) **Variantide arv** 1
- (30) **Prioriteediandmed** M20060171, 12.09.2006, FI
- (72) **Autor** Anna Klemetilä, Toivoniementie 7 as 10, 90500 Oulu, FI
Hanna Vuolteenaho, Valtatie 45 A 9, 90500 Oulu, FI
Jonne Harju, Perustie 10C 40, 00330 Helsinki, FI
- (73) **Omanik** Nokia Corporation, Keilalahdentie 4, FIN-02150 Espoo, FI
- (74) **Patendivolinik või ühine esindaja** Jüri Käosaar

(51) Klass: 14-03

(54) **Nimetus** **Käsitelefon**(55) **Reproduktsoon**

01306-01

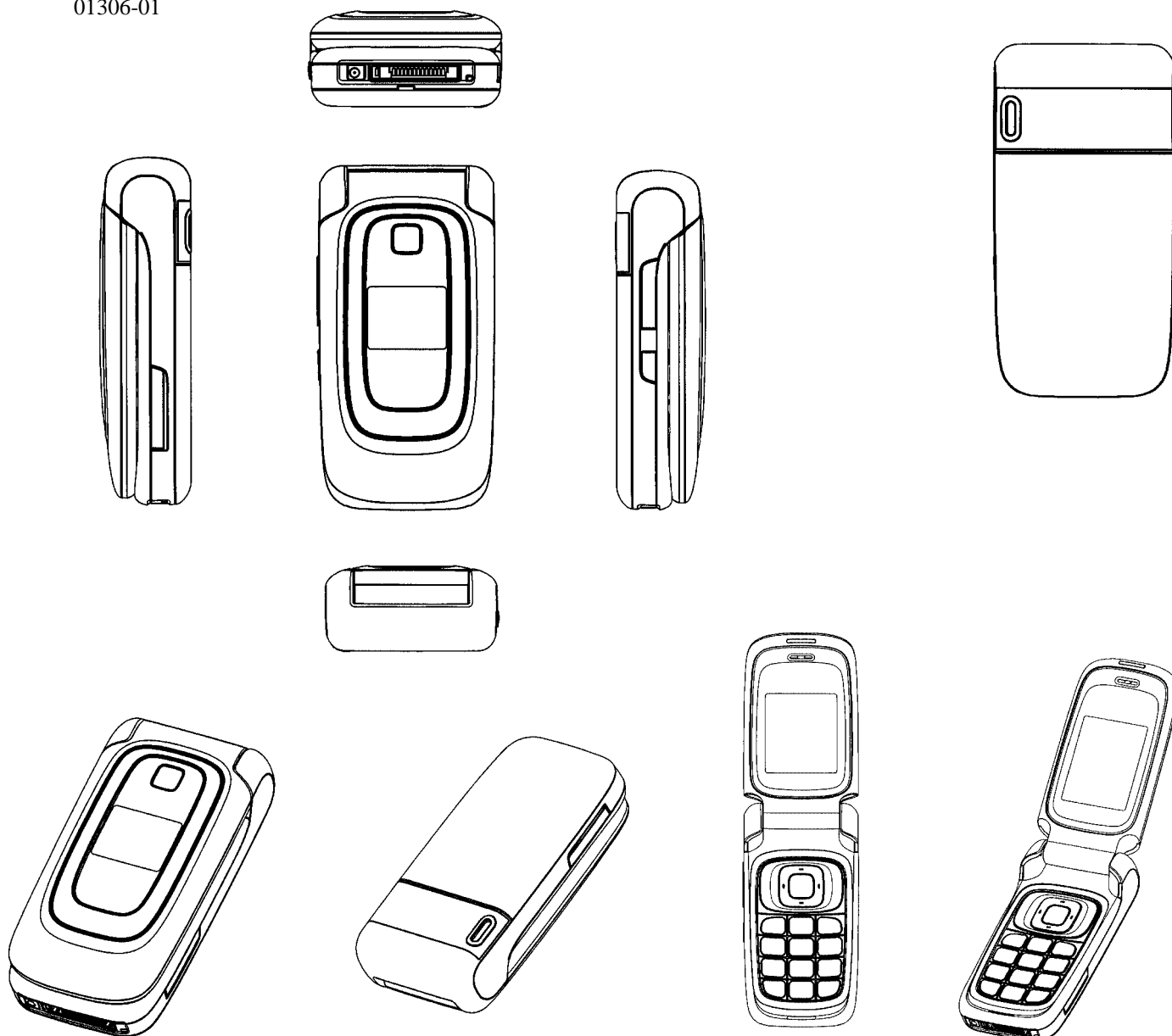

- (11) **Registreeringu number** **01307** (51) Klass: **14-03**
- (21) **Taotluse number** D200700015
- (15) **Registreerimise päev** 15.05.2007
- (22) **Esitamise päev** 09.03.2007
- (24) **Registreeringu kehtivuse alguse päev** 09.03.2007
- (18) **Registreeringu kehtivuse lõppemise päev** 09.03.2012
- (28) **Variantide arv** 1
- (30) **Prioriteediandmed** M20060196, 26.10.2006, FI
- (72) **Autor** Aaron Moss, 33 Queens Road, North Warnborough, Hampshire RG29 1DN, GB
Mikko Aarras, Poutuntie 7 A 1, 00400 Helsinki, FI
Anthony Dalby, 30, Chandos Avenue, Ealing, London W5 4ER, GB
Daniel Gratiot, 9 Lion Court, 12 Shand Street, London SE1 2EP, GB
- (73) **Omanik** Nokia Corporation, Keilalahdentie 4, FIN-02150 Espoo, FI
- (74) **Patendivolinik või ühine esindaja** Jüri Käosaar

(54) **Nimetus** **Käsitelefon**

(55) **Reproduktsoon**

01307-01

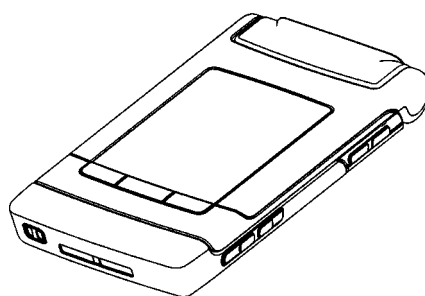
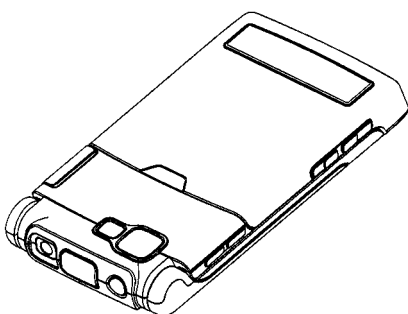
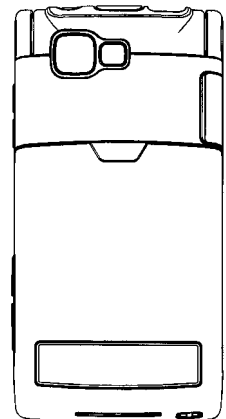
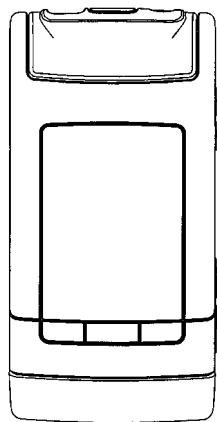
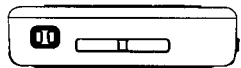

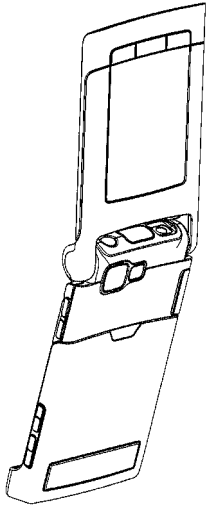
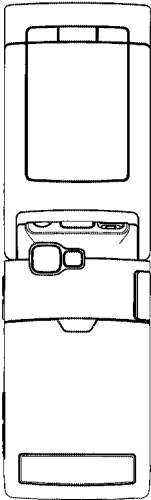
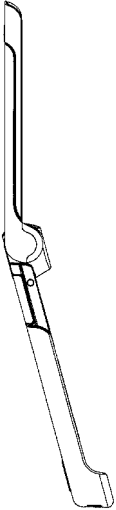
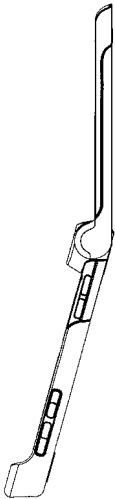
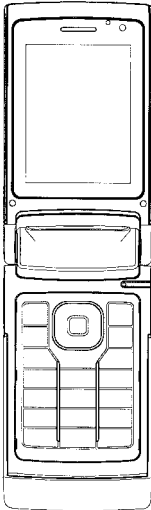

(11) **Registreeringu number** **01308**

(51) Klass: **06-06**

(21) **Taotluse number** D200700021

(15) **Registreerimise päev** 15.05.2007

(22) **Esitamise päev** 15.03.2007

(24) **Registreeringu kehtivuse alguse päev** 15.03.2007

(18) **Registreeringu kehtivuse lõppemise päev** 15.03.2012

(28) **Variantide arv** 1

(72) **Autor** Raul Boberg, Akadeemia tee 47, 12613 Tallinn, EE

(73) **Omanik** Palmers Eksport OÜ, Akadeemia tee 47, 12613 Tallinn, EE

(74) **Patendivolinik või ühine esindaja** Lembit Mitt

(54) **Nimetus** **Mööblirosett**

(55) **Reproduktsoon**

01308-01



(11) **Registreeringu number** **01309**

(51) Klass: **06-06**

(21) **Taotluse number** D200700022

(15) **Registreerimise päev** 15.05.2007

(22) **Esitamise päev** 15.03.2007

(24) **Registreeringu kehtivuse alguse päev** 15.03.2007

(18) **Registreeringu kehtivuse lõppemise päev** 15.03.2012

(28) **Variantide arv** 1

(72) **Autor** Raul Boberg, Akadeemia tee 47, 12613 Tallinn, EE

(73) **Omanik** Palmers Eksport OÜ, Akadeemia tee 47, 12613 Tallinn, EE

(74) **Patendivolinik või ühine esindaja** Lembit Mitt

(54) **Nimetus** **Mööbliehisliist**

(55) **Reproduktsoon**

01309-01



(11) **Registreeringu number** **01310**

(51) Klass: **06-06**

(21) **Taotluse number** D200700023

(15) **Registreerimise päev** 15.05.2007

(22) **Esitamise päev** 15.03.2007

(24) **Registreeringu kehtivuse alguse päev** 15.03.2007

(18) **Registreeringu kehtivuse lõppemise päev** 15.03.2012

(28) **Variantide arv** 1

(72) **Autor** Raul Boberg, Akadeemia tee 47, 12613 Tallinn, EE

(73) **Omanik** Palmers Eksport OÜ, Akadeemia tee 47, 12613 Tallinn, EE

(74) **Patendivolinik või ühine esindaja** Lembit Mitt

(54) **Nimetus** **Mööblikarniis**

(55) **Reproduktsoon**

01310-01

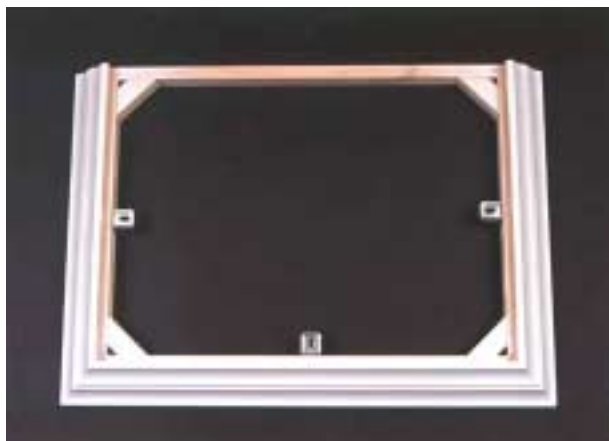

II. RAHVUSVAHELISELT REGISTREERITUD TÖÖSTUSDISAINILAHENDUSED

Avaldatakse "Tööstusdisaini kaitse seaduse" § 87⁴ lõike 3 alusel.

(11) Rahvusvah reg nr	DM/067991	(51) Klass: 10-02
(21) Rahvusvah reg jrk	H200600099	
(15) Registreeringu päev	13.07.2006	
(22) Esitamise päev	13.07.2006	
(28) Variantide arv	1	
(72) Autor	Sara HOFFMANN, DUPONT DESIGN SA, Route des Jeunes 33, CH-1227 CAROUGE, CH	
(73) Omanik	SWATCH AG (SWATCH SA) (SWATCH LTD.), 94, Rue Jakob Stämpfli, CH-2502 BIENNE, CH	
WIPO Rahvusvah Tööstusdisainilahenduste Bülletääni nr, kus registreering on avaldatud	2006/07	

(54) **Nimetus** **Wristwatch**

(55) **Reproduksioon**

DM/067991-01



(11) Rahvusvah reg nr	DM/067993	(51) Klass: 10-02
(21) Rahvusvah reg jrk	H200600098	
(15) Registreeringu päev	13.07.2006	
(22) Esitamise päev	13.07.2006	
(28) Variantide arv	1	
(72) Autor	Marco DRAGOTTA, SWATCHLAB, Via Archimede 6, IT-20129 MILANO, IT	
(73) Omanik	SWATCH AG (SWATCH SA) (SWATCH LTD.), 94, Rue Jakob Stämpfli, CH-2502 BIENNE, CH	
WIPO Rahvusvah Tööstusdisainilahenduste Bülletääni nr, kus registreering on avaldatud	2006/07	

(54) **Nimetus** **Wristwatch**

(55) **Reproduktsoon**

DM/067993-01



(11) Rahvusvah reg nr	DM/067994	(51) Klass: 10-02
(21) Rahvusvah reg jrk	H200600097	
(15) Registreeringu päev	13.07.2006	
(22) Esitamise päev	13.07.2006	
(28) Variantide arv	1	
(72) Autor	Walter GARRO, SWATCHLAB, Via Archimede 6, IT-20129 MILANO, IT	
(73) Omanik	SWATCH AG (SWATCH SA) (SWATCH LTD.), 94, Rue Jakob Stämpfli, CH-2502 BIENNE, CH	
WIPO Rahvusvah Tööstusdisainilahenduste Bülletääni nr, kus registreering on avaldatud	2006/07	

(54) **Nimetus** **Wristwatch**

(55) **Reproduksioon**

DM/067994-01



(11) Rahvusvah reg nr	DM/068001	(51) Klass: 10-02
(21) Rahvusvah reg jrk	H200600096	
(15) Registreeringu päev	13.07.2006	
(22) Esitamise päev	13.07.2006	
(28) Variantide arv	1	
(72) Autor	Léonie COCQUIO, DUPONT DESIGN SA, Route des Jeunes 33, CH-1227 CAROUGE, CH	
(73) Omanik	SWATCH AG (SWATCH SA) (SWATCH LTD.), 94, Rue Jakob Stämpfli, CH-2502 BIENNE, CH	
WIPO Rahvusvah Tööstusdisainilahenduste Bülletääni nr, kus registreering on avaldatud	2006/07	

(54) **Nimetus** **Wristwatch**

(55) **Reproduksioon**

DM/068001-01



(11) Rahvusvah reg nr	DM/068002	(51) Klass: 10-02
(21) Rahvusvah reg jrk	H200600095	
(15) Registreeringu päev	13.07.2006	
(22) Esitamise päev	13.07.2006	
(28) Variantide arv	1	
(72) Autor	Davide MARIANI, SWATCHLAB, Via Archimede 6, IT-20129 Milano, IT	
(73) Omanik	SWATCH AG (SWATCH SA) (SWATCH LTD.), 94, Rue Jakob Stämpfli, CH-2502 BIENNE, CH	
WIPO Rahvusvah Tööstusdisainilahenduste Bülletääni nr, kus registreering on avaldatud	2006/07	

(54) **Nimetus** **Wristwatch**

(55) **Reproduksioon**

DM/068002-01



(11) Rahvusvah reg nr	DM/068003	(51) Klass: 10-02
(21) Rahvusvah reg jrk	H200600094	
(15) Registreeringu päev	13.07.2006	
(22) Esitamise päev	13.07.2006	
(28) Variantide arv	1	
(72) Autor	Ciara Baudet, DUPONT DESIGN SA, Route des Jeunes 33, CH-1227 CAROUGE, CH	
(73) Omanik	SWATCH AG (SWATCH SA) (SWATCH LTD.), 94, Rue Jakob Stämpfli, CH-2502 BIENNE, CH	
WIPO Rahvusvah Tööstusdisainilahenduste Bülletääni nr, kus registreering on avaldatud	2006/07	

(54) **Nimetus** **Wristwatch**

(55) **Reproduksioon**

DM/068003-01



(11) Rahvusvah reg nr	DM/068004	(51) Klass: 10-02
(21) Rahvusvah reg jrk	H200600093	
(15) Registreeringu päev	13.07.2006	
(22) Esitamise päev	13.07.2006	
(28) Variantide arv	1	
(72) Autor	Adelina BISSOLO, SWATCHLAB, Via Archimede 6, IT-20129 MILANO, IT	
(73) Omanik	SWATCH AG (SWATCH SA) (SWATCH LTD.), 94, Rue Jakob Stämpfli, CH-2502 BIENNE, CH	
WIPO Rahvusvah Tööstusdisainilahenduste Bülletääni nr, kus registreering on avaldatud	2006/07	

(54) **Nimetus** **Wristwatch**

(55) **Reproduksioon**

DM/068004-01



(11) Rahvusvah reg nr	DM/068035	(51) Klass: 10-02
(21) Rahvusvah reg jrk	H200600092	
(15) Registreeringu päev	25.07.2006	
(22) Esitamise päev	25.07.2006	
(28) Variantide arv	1	
(72) Autor	Katia DE CONTI, DUPONT DESIGN SA, Route des Jeunes 33, CH-1227 CAROUGE, CH	
(73) Omanik	SWATCH AG (SWATCH SA) (SWATCH LTD.), 94, Rue Jakob Stämpfli, CH-2502 BIENNE, CH	
WIPO Rahvusvah Tööstusdisainilahenduste Bülletääni nr, kus registreering on avaldatud	2006/07	

(54) **Nimetus** **Wristwatch**

(55) **Reproduksioon**

DM/068035-01



(11) Rahvusvah reg nr	DM/068154	(51) Klass: 10-07
(21) Rahvusvah reg jrk	H200600102	
(15) Registreeringu päev	13.09.2006	
(22) Esitamise päev	13.09.2006	
(28) Variantide arv	1	
(72) Autor	Paulo Manuel BRAVO MARINHO, Chemin de la Forêt 3, CH-2068 HAUTERIVE, CH	
(73) Omanik	CERTINA AG (CERTINA SA) (CERTINA LTD), Chemin des Tourelles 17, CH-2400 Le Locle, CH	
WIPO Rahvusvah Tööstusdisainilahenduste Bülletääni nr, kus registreering on avaldatud	2006/09	

(54) **Nimetus** Watch case with bracelet

(55) **Reproduksioon**

DM/068154-01



(11) Rahvusvah reg nr	DM/068154	(51) Klass: 10-07
(21) Rahvusvah reg jrk	H200600102A	
(15) Registreeringu päev	13.09.2006	
(22) Esitamise päev	13.09.2006	
(28) Variantide arv	1	
(72) Autor	Paulo Manuel BRAVO MARINHO, Chemin de la Forêt 3, CH-2068 HAUTERIVE, CH	
(73) Omanik	CERTINA AG (CERTINA SA) (CERTINA LTD), Chemin des Tourelles 17, CH-2400 Le Locle, CH	
WIPO Rahvusvah Tööstusdisainilahenduste Bülletääni nr, kus registreering on avaldatud	2006/09	

(54) **Nimetus** Watch case

(55) **Reproduksioon**

DM/068154-01



(11) **Rahvusvah reg nr****DM/068156**(51) Klass: **11-01**(21) **Rahvusvah reg jrk**

H200600103

(15) **Registreeringu päev**

13.09.2006

(22) **Esitamise päev**

13.09.2006

(28) **Variantide arv**

2

(72) **Autor**Arlette Elsa EMCH DUCOMMUN, Rue des Mornets 31,
CH-2520 LA NEUVEVILLE, CH(73) **Omanik**THE SWATCH GROUP MANAGEMENT SERVICES AG
(THE SWATCH GROUP MANAGEMENT SERVICES SA),
(THE SWATCH GROUP MANAGEMENT SERVICES LTD),
Seevorstadt 6, CH-2502 Biel/Bienne, CH**WIPO Rahvusvah Tööstusdisainilahenduste
Bülletääni nr, kus registreering on avaldatud**

2006/09

(54) **Nimetus****Jewelry, in particular necklaces**(55) **Reproduktsoon**

DM/068156-01

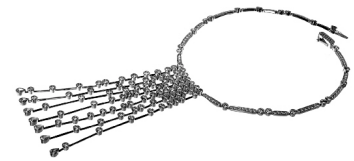

DM/068156-02



(11) Rahvusvah reg nr	DM/068156	(51) Klass: 11-01
(21) Rahvusvah reg jrk	H200600103A	
(15) Registreeringu päev	13.09.2006	
(22) Esitamise päev	13.09.2006	
(28) Variantide arv	2	
(72) Autor	Arlette Elsa EMCH DUCOMMUN, Rue des Mornets 31, CH-2520 LA NEUVEVILLE, CH	
(73) Omanik	THE SWATCH GROUP MANAGEMENT SERVICES AG (THE SWATCH GROUP MANAGEMENT SERVICES SA), (THE SWATCH GROUP MANAGEMENT SERVICES LTD), Seevorstadt 6, CH-2502 Biel/Bienne, CH	

**WIPO Rahvusvah Tööstusdisainilahenduste
Bülletääni nr, kus registreering on avaldatud** 2006/09

(54) **Nimetus** **Jewelry, in particular necklaces**

(55) **Reproduksioon**

DM/068156-01



DM/068156-02



(11) Rahvusvah reg nr	DM/068183	(51) Klass: 99-00
(21) Rahvusvah reg jrk	H200600104	
(15) Registreeringu päev	03.04.2006	
(22) Esitamise päev	03.04.2006	
(28) Variantide arv	2	
(30) Prioriteediandmed	0502.174, 07.10.2005, ES - variant 01 0503.093, 31.03.2006, ES - variant 01	
(72) Autor	ANTONIO ARAGON DIAZ, c/Los Madroños, nave 13A, Polígono Industrial La mina, COLMENAR VIEJO, 28770 MADRID, ES EDUARDO GUERRERO LOPEZ, c/Los Madroños, nave 13A, Polígono Industrial La mina, COLMENAR VIEJO, 28770 MADRID, ES MANUEL MARIA ROMAN SARALEGUI, c/Los Madroños, nave 13A, Polígono Industrial La mina, COLMENAR VIEJO, 28770 MADRID, ES PETS ENTERTAINMENT, S.L., c/Los Madroños, nave 13A, Polígono Industrial La Mina, COLMENAR VIEJO, E-28770 Madrid, ES	
(73) Omanik		
WIPO Rahvusvah Tööstusdisainilahenduste Bülletääni nr, kus registreering on avaldatud	2006/9	

(54) **Nimetus** **Designs for affixing to all types of surfaces**

(55) **Reproduksioon**

DM/068183-01



DM/068183-02



III. REGISTREERINGU KEHTIVUSE PIKENDAMINE

(11)	(18)		
00616	25.02.2012	00633	07.05.2012
00622	05.03.2012	00635	14.05.2012
00623	05.03.2012	00640	21.03.2012
00624	05.03.2012	00641	13.05.2012
00625	05.03.2012	00645	27.05.2012
00626	05.03.2012	00646	30.05.2012
00627	05.03.2012	00665	27.05.2012
00628	05.03.2012	00672	12.04.2012
00630	21.03.2012	00674	07.05.2012
00631	12.04.2012	00712	26.09.2012
00632	22.04.2012	00727	17.10.2012

VI. MUUD REGISTREERINGU ANDMETE MUUDATUSED

Reg nr	Muudetud andmed	Registrikande jõustumise päev
00609	Reckitt Benckiser N.V., Siriusdreef 14, 2132 WT Hoofddorp, NL	22.02.2007

VII. REGISTREERINGU ANDMETE PARANDUSED

Reg nr	Parandatavad andmed	Parandatud andmed
01174	Dimitre D. Mehandjiysky, 3535 East 1st Street, Belmont Shore, California 90803, US Tanja Fisher, 40B Strawberry Hill Road, Twickenham, Middlesex TW1 4PU, GB Tej Chauhan, 109 Beverley Drive, Edgware, Middlesex HA8 5NH, GB Helin Totti, Köydenpunojankatu 7 B 21, 00180 Helsinki, FI Grace Boicel, 105 a Sheen Lane, SW14 8AE London, FI Valerie Pegon, 13B Sheen Lane, East Sheen, London SW14 8HY, GB	Dimitre D. Mehandjiysky, 3535 East 1st Street, Belmont Shore, California 90803, US Tanja Fisher, 40B Strawberry Hill Road, Twickenham, Middlesex TW1 4PU, GB Tej Chauhan, 109 Beverley Drive, Edgware, Middlesex HA8 5NH, GB Helin Totti, Köydenpunojankatu 7 B 21, 00180 Helsinki, FI Grace Boicel, 105 a Sheen Lane, SW14 8AE London, GB Valerie Pegon, 13B Sheen Lane, East Sheen, London SW14 8HY, GB
01175	Dimitre D. Mehandjiysky, 3535 East 1st Street, Belmont Shore, California 90803, US Tanja Fisher, 40B Strawberry Hill Road, Twickenham, Middlesex TW1 4PU, GB Tej Chauhan, 109 Beverley Drive, Edgware, Middlesex HA8 5NH, GB Helin Totti, Köydenpunojankatu 7 B 21, 00180 Helsinki, FI Grace Boicel, 105 a Sheen Lane, SW14 8AE London, FI Valerie Pegon, 13B Sheen Lane, East Sheen, London SW14 8HY, GB	Dimitre D. Mehandjiysky, 3535 East 1st Street, Belmont Shore, California 90803, US Tanja Fisher, 40B Strawberry Hill Road, Twickenham, Middlesex TW1 4PU, GB Tej Chauhan, 109 Beverley Drive, Edgware, Middlesex HA8 5NH, GB Helin Totti, Köydenpunojankatu 7 B 21, 00180 Helsinki, FI Grace Boicel, 105 a Sheen Lane, SW14 8AE London, GB Valerie Pegon, 13B Sheen Lane, East Sheen, London SW14 8HY, GB

Reg nr	Parandatavad andmed	Parandatud andmed
01181	Dimitre D. Mehandjiysky, 3535 East 1st Street, Belmont Shore, California 90803, US Tanja Fisher, 40B Strawberry Hill Road, Twickenham, Middlesex TW1 4PU, GB Tej Chauhan, 109 Beverley Drive, Edgware, Middlesex HA8 5NH, GB Helin Totti, Köydenpunojankatu 7 B 21, 00180 Helsinki, FI Grace Boicel, 105 a Sheen Lane, SW14 8AE London, FI Valerie Pegon, 13B Sheen Lane, East Sheen, London SW14 8HY, GB	Dimitre D. Mehandjiysky, 3535 East 1st Street, Belmont Shore, California 90803, US Tanja Fisher, 40B Strawberry Hill Road, Twickenham, Middlesex TW1 4PU, GB Tej Chauhan, 109 Beverley Drive, Edgware, Middlesex HA8 5NH, GB Helin Totti, Köydenpunojankatu 7 B 21, 00180 Helsinki, FI Grace Boicel, 105 a Sheen Lane, SW14 8AE London, GB Valerie Pegon, 13B Sheen Lane, East Sheen, London SW14 8HY, GB
01220	Kati Björninen, Topeliuksenkatu 10 A, 00250 Helsinki, FI	Kati Björninen, Topeliuksenkatu 19 A 33 , 00250 Helsinki, FI
01221	Ian Buckle, The Lodge, Glade Mews, Guildford, Surrey GU1 2EZ, GB Anthony Dalby, 30, Chandos Avenue, Ealing, London W5 4ER, GB	Ian Buckle, 8 The Lodge, Glade Mews, Guildford, Surrey GU1 2EZ, GB Anthony Dalby, 30, Chandos Avenue, Ealing, London W5 4ER, GB

XI. TÖÖSTUSDISAINILAHENDUSE KUSTUTAMINE REGISTRIST

"Tööstusdisaini kaitse seaduse" paragrahvi 77 lõike 1 alusel on registrist kustutatud järgmised tööstusdisainilahendused:

Reg nr	Kustutamise jõustumise päev
00584	07.09.2006
00586	30.07.2006
00591	29.08.2006
00592	08.10.2006
00593	13.08.2006
00601	13.08.2006
00607	18.10.2006
00629	25.09.2006

XII. LOENDID

REGISTREERITUD TÖÖSTUSDISAINILAHENDUSTE SÜSTEMAATILINE LOEND

Rahvusvahelise klassifikatsiooni klass ja alaklass(id)	Registreerimis-taotluse number	Registreeringu number			
02-02	D200700010	01302	14-03	D200700003	01297
02-06	D200600105	01290	14-03	D200700004	01298
06-01	D200600063	01270	14-03	D200700005	01299
06-06	D200700021	01308	14-03	D200700006	01300
06-06	D200700022	01309	14-03	D200700007	01301
06-06	D200700023	01310	14-03	D200700011	01303
06-11	D200600066	01285	14-03	D200700014	01306
06-11	D200600066A	01286	14-03	D200700015	01307
06-11	D200600066B	01287	19-04	D200700012	01304
06-12	D200600066	01285	19-07	D200700012	01304
06-12	D200600066A	01286	19-08	D200700012	01304
06-12	D200600066B	01287	20-02	D200600063B	01272
09-03	D200600063J	01280	20-02	D200700013	01305
09-09	D200600063A	01271	20-03	D200600063D	01274
11-02	D200600042	01269	20-03	D200600063H	01278
11-02	D200600065	01282	20-03	D200600063I	01279
11-02	D200600065A	01283	23-02	D200600063F	01276
11-02	D200600065B	01284	25-01	D200600063C	01273
11-02	D200600066	01285	25-01	D200600063K	01281
11-02	D200600066A	01286	25-02	D200600063C	01273
11-02	D200600066B	01287	25-02	D200600063K	01281
14-03	D200600108	01291	25-03	D200600063E	01275
14-03	D200600109	01292	25-03	D200600063F	01276
14-03	D200600110	01293	25-03	D200700013	01305
14-03	D200600111	01294	26-01	D200600104	01289
14-03	D200600112	01295	26-03	D200600063G	01277
14-03	D200700002	01296	28-02	D200600103	01288

REGISTREERITUD TÖÖSTUSDISAINILAHENDUSTE REGISTREERIMISTAOTLUSTE NUMBRILINE LOEND

Registreerimis-taotluse number	Registreeringu number	Rahvusvahelise klassifikatsiooni klass(id) ja alaklass(id)			
D200600042	01269	11-02	D200600065	01282	11-02
D200600063	01270	06-01	D200600065A	01283	11-02
D200600063A	01271	09-09	D200600065B	01284	11-02
D200600063B	01272	20-02	D200600066	01285	06-11
D200600063C	01273	25-01	D200600066	01285	06-12
D200600063C	01273	25-02	D200600066	01285	11-02
D200600063D	01274	20-03	D200600066A	01286	06-11
D200600063E	01275	25-03	D200600066A	01286	06-12
D200600063F	01276	23-02	D200600066A	01286	11-02
D200600063F	01276	25-03	D200600066B	01287	06-11
D200600063G	01277	26-03	D200600066B	01287	06-12
D200600063H	01278	20-03	D200600066B	01287	11-02
D200600063I	01279	20-03	D200600103	01288	28-02
D200600063J	01280	09-03	D200600104	01289	26-01
D200600063K	01281	25-01	D200600105	01290	02-06
D200600063K	01281	25-02	D200600108	01291	14-03

Registreerimis- taotluse number	Registreeringu number	Rahvusvahelise klassifikatsiooni klass(id) ja alaklass(id)
------------------------------------	--------------------------	--

D200600109	01292	14-03	D200700011	01303	14-03
D200600110	01293	14-03	D200700012	01304	19-04
D200600111	01294	14-03	D200700012	01304	19-07
D200600112	01295	14-03	D200700012	01304	19-08
D200700002	01296	14-03	D200700013	01305	20-02
D200700003	01297	14-03	D200700013	01305	25-03
D200700004	01298	14-03	D200700014	01306	14-03
D200700005	01299	14-03	D200700015	01307	14-03
D200700006	01300	14-03	D200700021	01308	06-06
D200700007	01301	14-03	D200700022	01309	06-06
D200700010	01302	02-02	D200700023	01310	06-06

**AVALDATUD RAHVUSVAHELISE REGISTREERINGU REGISTREERIMISE
OTSUSE TEADETE NUMBRILINE LOEND**

DM/067991
DM/067993
DM/067994
DM/068001
DM/068002
DM/068003
DM/068004
DM/068035
DM/068154
DM/068154
DM/068156
DM/068156
DM/068183

XIII. TÖÖSTUSDISAINIALASED ÕIGUSAKTID JA MUU INFO**RIIKLIKUS PATENDIVOLNIKE REGISTRIS REGISTREERITUD PATENDIVOLNIKE NIMEKIRI**
(seisuga 19. detsember 2006)

Register on asutatud 1. septembril 2001. a Vabariigi Valitsuse 7. augusti 2001. a määrusega nr 271 "Riikliku patendivolinike registri asutamine ja registri pidamise põhimäärus" (RT I 2001, 70, 426) patendivoliniku seaduse § 21 alusel (RT I 2001, 27, 151).

TEGEVUSVALDKOND: KAUBAMÄRK, TÖÖSTUSDISAINILAHENDUS JA GEOGRAAFILINE TÄHIS

Arno ANIJALG	OÜ USTERVALL Kivi 21-6 51009 Tartu pk 21, 50002 Tartu telefon: 744 1980 telefaks: 744 1785 e-post: anijalg@ustervall.ee http://www.ustervall.ee võõrkeeled: saksa, vene	Juhan HÄMMALOV	OÜ Intels Riia 11-3 51010 Tartu telefon: 742 0401 telefaks: 742 0326 e-post: intelses@estpak.ee võõrkeeled: inglise, saksa, vene
Aivo ARULA	Patendibüroo Käosaar & Co OÜ Tähe 94 50107 Tartu telefon: 738 3051 telefaks: 738 3055 e-post: info@kaosaar.ee http://www.kaosaar.ee võõrkeeled: inglise, vene	Uno JÄÄGER	Inseneribüroo Uneko OÜ Rüütli 51a, 80010 Pärnu telefon: 447 1021 telefaks: 447 1001 GSM: 515 1844 e-post: uno@estpak.ee võõrkeeled: inglise, soome, vene
Martina BÖCKLER-LORVI	OÜ LASVET Suurtüki 4a, 10133 Tallinn pk 3136, 10505 Tallinn telefon: 640 6600 telefaks: 640 6604 e-post: lasvet@lasvet.ee http://www.lasvet.ee võõrkeeled: inglise, soome	Sirje KAHU	OÜ USTERVALL Kivi 21-6 51009 Tartu pk 21, 50002 Tartu telefon: 744 1980 telefaks: 744 1785 e-post: skahu@ustervall.ee http://www.ustervall.ee võõrkeeled: inglise, vene
Indrek EELMETS	OÜ LASVET Suurtüki 4a, 10133 Tallinn pk 3136, 10505 Tallinn telefon: 640 6600 telefaks: 640 6604 e-post: lasvet@lasvet.ee http://www.lasvet.ee võõrkeeled: inglise, vene, soome	Lembit KALEV	Patendibüroo ROOSILLA OÜ Järveotsa tee 39-61 13520 Tallinn telefon: 657 1722, 657 5381 telefaks: 657 5381 GSM: 511 9951 e-post: roosilla@roosilla.ee http://www.roosilla.ee võõrkeeled: inglise, vene
Alla HÄMMALOV	OÜ Intels Riia 11-3 51010 Tartu telefon: 742 0401 telefaks: 742 0326 e-post: intelses@estpak.ee võõrkeeled: inglise, poola, vene	Anneli KANG	OÜ Synest pk 977, 13402 Tallinn telefon: 660 9786 telefaks: 660 9787 e-post: anneli@synest.ee võõrkeeled: inglise, saksa, vene, prantsuse, soome, rootsi

- Urmas KAULER** **Patendibüroo TURVAJA OÜ**
 Liivalaia 22
 10118 Tallinn
 telefon: 640 3109
 telefaks: 640 3105
 e-post: kauler@turvaja.ee
 http://www.turvaja.ee
 võõrkeeled: inglise, vene, soome
- Urmas KERNU** **AAA Patendibüroo OÜ**
 Tartu mnt 16
 10117 Tallinn
 pk 3926, 10509 Tallinn
 telefon: 660 5910, 660 5911
 telefaks: 660 5912
 e-post: aaa@aaa.ee
 http://www.aaa.ee
 võõrkeeled: inglise, saksa, soome, vene
- Ljubov KESSELMAN** **OÜ Kesna**
 Tedre 77-52
 10616 Tallinn
 telefon: 660 8068
 telefaks: 660 8069
 e-post: kesna@kesna.ee
 http://www.kesna.ee
 võõrkeeled: inglise, vene
- Marina KESSELMAN** **OÜ Kesna**
 Tedre 77-52
 10616 Tallinn
 telefon: 660 8068
 telefaks: 660 8069
 e-post: kesna@kesna.ee
 http://www.kesna.ee
 võõrkeeled: inglise, saksa, vene
- Heinu KOITEL** **Patendi- & Kaubamärgibüroo Koitel OÜ**
 Tartu mnt 65
 10115 Tallinn
 pk 1759, 10902 Tallinn
 telefon: 603 3260
 telefaks: 603 3261
 e-post: koitel@koitel.ee
 http://www.koitel.ee
 võõrkeeled: inglise, soome, vene
- Raivo KOITEL** **Patendi- & Kaubamärgibüroo Koitel OÜ**
 Tartu mnt 65
 10115 Tallinn
 pk 1759, 10902 Tallinn
 telefon: 603 3260
 telefaks: 603 3261
 e-post: koitel@koitel.ee
 http://www.koitel.ee
 võõrkeeled: inglise, soome, vene
- Mart Enn KOPPEL** **Patendibüroo Koppel OÜ**
 Kajaka 4-10
 11317 Tallinn
 telefon: 677 4136
 telefaks: 677 4138
 e-post: info@koppelpb.com
 http://www.koppelpb.com
 võõrkeeled: inglise, vene, soome
- Heinrich KRUPP** **Patendibüroo TURVAJA OÜ**
 Liivalaia 22
 10118 Tallinn
 telefon: 640 3109
 telefaks: 640 3105
 e-post: turvaja@turvaja.ee
 http://www.turvaja.ee
 võõrkeeled: saksa, vene
- Jüri KÄOSAAR** **Patendibüroo Käosaar & Co OÜ**
 Tähe 94
 50107 Tartu
 telefon: 738 3051
 telefaks: 738 3055
 e-post: info@kaosaar.ee
 http://www.kaosaar.ee
 võõrkeeled: inglise, vene
- Kalev KÄOSAAR** **Patendibüroo Käosaar & Co OÜ**
 Peterburi tee 46
 11415 Tallinn
 telefon: 637 9484
 telefaks: 637 9485
 e-post: kalev.kaosaar@kaosaar.ee
 http://www.kaosaar.ee
 võõrkeeled: inglise, vene
- Reet MAASIKAMÄE** **OÜ Kaitsepurus**
 Mulla 4-3
 10611 Tallinn
 telefon: 673 9097, 633 2798
 telefaks: 677 4844
 e-post: purus@online.ee
 purus@hot.ee
 http://www.hot.ee/purus/
 võõrkeeled: inglise, vene
- Raivo MATSOO** **RM Hirvela Patendibüroo OÜ**
 Saku 15, 11314 Tallinn
 telefon: 614 0816
 telefaks: 614 0818
 e-post: hirvela@hirvela.ee
 võõrkeeled: inglise, vene

Elle MELLIK	AAA Patendibüroo OÜ Tartu mnt 16 10117 Tallinn pk 3926, 10509 Tallinn telefon: 660 5910, 660 5911 telefaks: 660 5912 e-post: aaa@aaa.ee http://www.aaa.ee võõrkeeled: inglise, vene	Jaak OSTRAT	OÜ LASVET Suurtüki 4a, 10133 Tallinn pk 3136, 10505 Tallinn telefon: 640 6600 telefaks: 640 6604 e-post: lasvet@lasvet.ee http://www.lasvet.ee võõrkeeled: inglise, saksa, soome, vene
Lembit MITT	AAA Patendibüroo OÜ Tartu mnt 16 10117 Tallinn pk 3926, 10509 Tallinn telefon: 660 5910, 660 5911 telefaks: 660 5912 e-post: aaa@aaa.ee http://www.aaa.ee võõrkeeled: inglise, vene	Villu PAVELTS	OÜ LASVET Suurtüki 4a, 10133 Tallinn pk 3136, 10505 Tallinn telefon: 640 6600 telefaks: 640 6604 e-post: lasvet@lasvet.ee http://www.lasvet.ee võõrkeeled: inglise, soome, vene
Ott MOORLAT	OÜ Moorlat & Ko Patendibüroo pk 723, 12902 Tallinn telefon: 655 0450, 654 2844 telefaks: 654 2844 e-post: ott.moorlat@moorlat.ee http://www.moorlat.ee võõrkeeled: inglise, vene	Toom PUNGAS	OÜ Synest pk 977, 13402 Tallinn telefon: 660 9786 telefaks: 660 9787 e-post: toom@synest.ee võõrkeeled: inglise, saksa, soome, vene
Anfia MORNA	Patendibüroo TURVAJA OÜ Liivalaia 22, 10118 Tallinn telefon: 640 3109 telefaks: 640 3105 e-post: morna@turvaja.ee http://www.turvaja.ee võõrkeeled: inglise, vene	Kaie PUUR	Patendibüroo Käosaar & Co OÜ Tähe 94 50107 Tartu telefon: 738 3051 telefaks: 738 3055 e-post: info@kaosaar.ee http://www.kaosaar.ee võõrkeeled: inglise, vene
Tõnu NELAS	AAA Patendibüroo OÜ Tartu mnt 16 10117 Tallinn pk 3926, 10509 Tallinn telefon: 660 5910, 660 5911 telefaks: 660 5912 e-post: aaa@aaa.ee http://www.aaa.ee võõrkeeled: inglise, vene, soome	Riina PÄRN	OÜ Intels Riia 11-3 51010 Tartu telefon: 742 0401 telefaks: 742 0326 e-post: intelses@estpak.ee võõrkeeled: inglise, vene
Jüri OLT	Patendibüroo Käosaar & Co OÜ Tähe 94, 50107 Tartu telefon: 738 3051 telefaks: 738 3055 e-post: info@kaosaar.ee http://www.kaosaar.ee võõrkeeled: inglise, saksa, soome, vene	Tarmo ROSMAN	Rosman ja Partnerid OÜ pk 652, 12602 Tallinn telefon: 656 1450 telefaks: 656 1450 e-post: tarman@cc.ttu.ee võõrkeeled: saksa, inglise, ungari, vene
		Arvo SALUMÄE	OÜ Amende Patendibüroo Raua 65 10152 Tallinn telefon: 648 6125 telefaks: 641 0174 e-post: amende@hot.ee võõrkeeled: inglise, saksa, soome, vene

Almar SEHVER**AAA Patendibüroo OÜ**

Tartu mnt 16
10117 Tallinn
pk 3926, 10509 Tallinn
telefon: 660 5910, 660 5911
telefaks: 660 5912
e-post: aaa@aaa.ee
<http://www.aaa.ee>
võõrkeeled: inglise, vene

Olga TREUFELDT**Patendibüroo TURVAJA OÜ**

Liivalaia 22
10118 Tallinn
telefon: 640 3109
telefaks: 640 3105
e-post: olga@turvaja.ee
<http://www.turvaja.ee>
võõrkeeled: inglise, vene

Harald TEHVER**Patendibüroo TURVAJA OÜ**

Liivalaia 22
10118 Tallinn
telefon: 640 3109
telefaks: 640 3105
e-post: tehver@turvaja.ee
<http://www.turvaja.ee>
võõrkeeled: inglise, saksa, vene

Enn URGAS**Patendibüroo TURVAJA OÜ**

Liivalaia 22
10118 Tallinn
telefon: 640 3109
telefaks: 640 3105
e-post: urgas@turvaja.ee
<http://www.turvaja.ee>
võõrkeeled: inglise, vene

Mari TOOMSOO**Patendibüroo Käosaar & Co OÜ**

Peterburi tee 46, 11415 Tallinn
telefon: 637 9484
telefaks: 637 9485
e-post: mari.toomsoo@kaosaar.ee
<http://www.kaosaar.ee>
võõrkeeled: inglise, soome

Juta-Maris UUSTALU**OÜ Amende Patendibüroo**

Raua 65
10152 Tallinn
telefon: 648 6125
telefaks: 641 0174
e-post: amende@hot.ee
võõrkeeled: inglise, vene

**LIST OF PATENT ATTORNEYS, REGISTERED IN
THE ESTONIAN STATE REGISTER OF PATENT ATTORNEYS**
(by 19 December 2006)

Register is established on September 1st 2001

FIELD OF ACTIVITY: TRADEMARKS, INDUSTRIAL DESIGNS AND GEOGRAPHICAL INDICATIONS

Arno ANIJALG	USTERVALL Ltd. Kivi 21-6 51009 Tartu, Estonia P.O. Box 21 50002 Tartu, Estonia Phone: +372 744 1980 Fax: +372 744 1785 E-mail: anijalg@ustervall.ee Http://www.ustervall.ee German, Russian, Estonian	Juhan HÄMMALOV	Intels Ltd. Riia Str. 11-3 51010 Tartu, Estonia Phone: +372 742 0401 Fax: +372 742 0326 E-mail: intelses@estpak.ee English, German, Russian, Estonian
Aivo ARULA	Patent Agency Käosaar & Co Tähe Str. 94 50107 Tartu, Estonia Phone: +372 738 3051 Fax: +372 738 3055 E-mail: info@kaosaar.ee Http://www.kaosaar.ee English, Russian, Estonian	Uno JÄÄGER	Inseneribüroo Uneko Ltd. Rüütli 51a 80010 Pärnu, Estonia Phone: +372 447 1021 Fax: +372 447 1001 GSM: +372 515 1844 E-mail: uno@estpak.ee English, Finnish, Russian, Estonian
Martina BÖCKLER-LORVI	Lasvet Ltd. P.O. Box 3136 10505 Tallinn, Estonia Phone: +372 640 6600 Fax: +372 640 6604 E-mail: lasvet@lasvet.ee Http://www.lasvet.ee English, Finnish, Estonian	Sirje KAHU	USTERVALL Ltd. Kivi 21-6 51009 Tartu, Estonia P.O. Box 21 50002 Tartu, Estonia Phone: +372 744 1980 Fax: +372 744 1785 E-mail: skahu@ustervall.ee Http://www.ustervall.ee English, Russian, Estonian
Indrek EELMETS	Lasvet Ltd. P.O. Box 3136 10505 Tallinn, Estonia Phone: +372 640 6600 Fax: +372 640 6604 E-mail: lasvet@lasvet.ee Http://www.lasvet.ee English, Finnish, Russian, Estonian	Lembit KALEV	Patent Bureau ROOSILLA Ltd. Järveotsa Road 39-61 13520 Tallinn, Estonia Phone: +372 657 1722 +372 657 5381 Fax: +372 657 5381 GSM: +372 511 9951 E-mail: roosilla@roosilla.ee Http://www.roosilla.ee English, Russian, Estonian
Alla HÄMMALOV	Intels Ltd. Riia Str. 11-3 51010 Tartu, Estonia Phone: +372 742 0401 Fax: +372 742 0326 E-mail: intelses@estpak.ee English, Polish, Russian, Estonian	Anneli KANG	Synest Ltd. P.O. Box 977 13402 Tallinn, Estonia Phone: +372 660 9786 Fax: +372 660 9787 E-mail: anneli@synest.ee English, German, Russian, French, Finnish, Swedish, Estonian

Urmast KAULER	Patendibüroo TURVAJA OÜ Liivalaia 22 10118 Tallinn, Estonia Phone: +372 640 3109 Fax: +372 640 3105 E-mail: kauler@turvaja.ee Http://www.turvaja.ee English, Russian, Finnish, Estonian	Raivo KOITEL	Patent & Trademark Agency Koitel Tartu Road 65 10115 Tallinn, Estonia P.O. Box 1759 10902 Tallinn, Estonia Phone: +372 603 3260 Fax: +372 603 3261 E-mail: koitel@koitel.ee Http://www.koitel.ee English, Finnish, Russian, Estonian
Urmast KERNU	AAA Legal Services Tartu Road 16 10117 Tallinn, Estonia P.O. Box 3926 10509 Tallinn, Estonia Phone: +372 660 5910 +372 660 5911 Fax: +372 660 5912 E-mail: aaa@aaa.ee Http://www.aaa.ee English, German, Finnish, Russian, Estonian	Mart Enn KOPPEL	Patent Bureau Koppel Kajaka 4-10 11317 Tallinn, Estonia Phone: +372 677 4136 Fax: +372 677 4138 E-mail: info@koppelpb.com Http://www.koppelpb.com English, Russian, Finnish, Estonian
Marina KESSELMAN	Kesna Ltd. Tedre Str. 77-52 10616 Tallinn, Estonia Phone: +372 660 8068 Fax: +372 660 8069 E-mail: kesna@kesna.ee Http://www.kesna.ee English, German, Russian, Estonian	Heinrich KRUPP	Patendibüroo TURVAJA OÜ Liivalaia 22 10118 Tallinn, Estonia Phone: +372 640 3109 Fax: +372 640 3105 E-mail: turvaja@turvaja.ee Http://www.turvaja.ee German, Russian, Estonian
Ljubov KESSELMAN	Kesna Ltd. Tedre Str. 77-52 10616 Tallinn, Estonia Phone: +372 660 8068 Fax: +372 660 8069 E-mail: kesna@kesna.ee Http://www.kesna.ee English, Russian, Estonian	Jüri KÄOSAAR	Patent Agency Käosaar & Co Tähe Str. 94 50107 Tartu, Estonia Phone: +372 738 3051 Fax: +372 738 3055 E-mail: info@kaosaar.ee Http://www.kaosaar.ee English, Russian, Estonian
Heinu KOITEL	Patent & Trademark Agency Koitel Tartu Road 65 10115 Tallinn, Estonia P.O. Box 1759 10902 Tallinn, Estonia Phone: +372 603 3260 Fax: +372 603 3261 E-mail: koitel@koitel.ee Http://www.koitel.ee English, Finnish, Russian, Estonian	Kalev KÄOSAAR	Patent Agency Käosaar & Co Peterburi Road 46 11415 Tallinn, Estonia Phone: +372 637 9484 Fax: +372 637 9485 E-mail: kalev.kaosaar@kaosaar.ee Http://www.kaosaar.ee English, Russian, Estonian

- Reet MAASIKAMÄE** **Patent Bureau Kaitsepurus Ltd.**
Mulla Str. 4-3
10611 Tallinn, Estonia
Phone: +372 673 9097
+372 633 2798
Fax: +372 677 4844
E-mail: purus@online.ee
purus@hot.ee
Http://www.hot.ee/purus/
English, Russian, Estonian
- Raivo MATSOO** **RM Hirvela Patent Bureau Ltd**
Saku 15, 11314 Tallinn, Estonia
Phone: +372 614 0816
Fax: +372 614 0818
E-mail: hirvela@hirvela.ee
English, Russian, Estonian
- Elle MELLIK** **AAA Legal Services**
Tartu Road 16
10117 Tallinn, Estonia
P.O. Box 3926
10509 Tallinn, Estonia
Phone: +372 660 5910
+372 660 5911
Fax: +372 660 5912
E-mail: aaa@aaa.ee
Http://www.aaa.ee
English, Russian, Estonian
- Lembit MITT** **AAA Legal Services**
Tartu Road 16
10117 Tallinn, Estonia
P.O. Box 3926
10509 Tallinn, Estonia
Phone: +372 660 5910
+372 660 5911
Fax: +372 660 5912
E-mail: aaa@aaa.ee
Http://www.aaa.ee
English, Russian, Estonian
- Ott MOORLAT** **Moorlat & Co Ltd. Patent Bureau**
P.O. Box 723
12902 Tallinn, Estonia
Phone: +372 655 0450
+372 654 2844
Fax: +372 654 2844
E-mail: ott.moorlat@moorlat.ee
Http://www.moorlat.ee
English, Russian, Estonian
- Anfia MORNA**
- Tõnu NELSAS**
- Patendibüroo TURVAJA OÜ**
Liivalaia 22
10118 Tallinn, Estonia
Phone: +372 640 3109
Fax: +372 640 3105
E-mail: morna@turvaja.ee
Http://www.turvaja.ee
English, Russian, Estonian
- AAA Legal Services**
Tartu Road 16
10117 Tallinn, Estonia
P.O. Box 3926
10509 Tallinn, Estonia
Phone: +372 660 5910
+372 660 5911
Fax: +372 660 5912
E-mail: aaa@aaa.ee
Http://www.aaa.ee
English, Russian, Finnish, Estonian
- Jüri OLT**
- Patent Agency Käosaar & Co**
Tähe Str. 94
50107 Tartu, Estonia
Phone: +372 738 3051
Fax: +372 738 3055
E-mail: info@kaosaar.ee
Http://www.kaosaar.ee
English, German, Finnish, Russian, Estonian
- Jaak OSTRAT**
- Lasvet Ltd.**
P.O. Box 3136
10505 Tallinn, Estonia
Phone: +372 640 6600
Fax: +372 640 6604
E-mail: lasvet@lasvet.ee
Http://www.lasvet.ee
English, German, Finnish, Russian, Estonian
- Villu PAVELTS**
- Lasvet Ltd.**
P.O. Box 3136
10505 Tallinn, Estonia
Phone: +372 640 6600
Fax: +372 640 6604
E-mail: lasvet@lasvet.ee
Http://www.lasvet.ee
English, Finnish, Russian, Estonian
- Toom PUNGAS**
- Synest Ltd.**
P.O. Box 977
13402 Tallinn, Estonia
Phone: +372 660 9786
Fax: +372 660 9787
E-mail: toom@synest.ee
English, German, Finnish, Russian, Estonian

- Kaie PUUR** **Patent Agency Käosaar & Co**
Tähe Str. 94
50107 Tartu, Estonia
Phone: +372 738 3051
Fax: +372 738 3055
E-mail: info@kaosaar.ee
Http://www.kaosaar.ee
English, Russian, Estonian
- Harald TEHVER** **Patendibüroo TURVAJA OÜ**
Liivalaia 22
10118 Tallinn, Estonia
Phone: +372 640 3109
Fax: +372 640 3105
E-mail: tehver@turvaja.ee
Http://www.turvaja.ee
English, German, Russian,
Estonian
- Riina PÄRN** **Intels Ltd.**
Riia Str. 11-3
51010 Tartu, Estonia
Phone: +372 742 0401
Fax: +372 742 0326
E-mail: intelses@estpak.ee
English, Russian,
Estonian
- Mari TOOMSOO** **Patent Agency Käosaar & Co**
Peterburi Str. 46
11415 Tallinn, Estonia
Phone: +372 637 9484
Fax: +372 637 9485
E-mail: mari.toomsoo@kaosaar.ee
Http://www.kaosaar.ee
English, Finnish, Estonian
- Tarmo ROSMAN** **Rosman and Partners Ltd.**
P.O. Box 652
12602 Tallinn, Estonia
Phone: +372 656 1450
Fax: +372 656 1450
E-mail: tarman@cc.ttu.ee
German, English, Hungarian,
Russian, Estonian
- Olga TREUFELDT** **Patendibüroo TURVAJA OÜ**
Liivalaia 22
10118 Tallinn, Estonia
Phone: +372 640 3109
Fax: +372 640 3105
E-mail: olga@turvaja.ee
Http://www.turvaja.ee
English, Russian, Estonian
- Arvo SALUMÄE** **AMENDE Patent Agency Ltd.**
Raua 65, 10152 Tallinn, Estonia
Phone: +372 648 6125
Fax: +372 641 0174
E-mail: amende@hot.ee
English, German, Finnish,
Russian, Estonian
- Enn URGAS** **Patendibüroo TURVAJA OÜ**
Liivalaia 22
10118 Tallinn, Estonia
Phone: +372 640 3109
Fax: +372 640 3105
E-mail: urgas@turvaja.ee
Http://www.turvaja.ee
English, Russian, Estonian
- Almar SEHVER** **AAA Legal Services**
Tartu Road 16
10117 Tallinn, Estonia
P.O. Box 3926
10509 Tallinn, Estonia
Phone: +372 660 5910
+372 660 5911
Fax: +372 660 5912
E-mail: aaa@aaa.ee
Http://www.aaa.ee
English, Russian, Estonian
- Juta-Maris UUSTALU** **AMENDE Patent Agency Ltd.**
Raua 65, 10152 Tallinn, Estonia
Phone: +372 648 6125
Fax: +372 641 0174
E-mail: amende@hot.ee
English, Russian, Estonian