



EESTI VABARIIK

**T** **EESTI**  
**TÖÖSTUSDISAINI-**  
**LAHENDUSE LEHT**



PATENDIAMETI AMETLIK VÄLJAANNE

**3**  
**2004**  
TALLINN

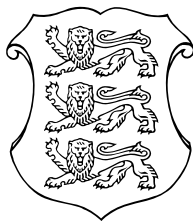

ISSN 1406-376X

EESTI VABARIIK

**T** **EESTI**  
**TÖÖSTUSDISAINI-**  
**LAHENDUSE LEHT**

**PATENDIAMETI  
AMETLIK VÄLJAANNE**

**VII aastakäik**

**Käesolevas numbris  
esitatud andmed  
loetakse avaldatuks  
16. augustil 2004. a.**

**3**  
**2004**  
AUGUST  
TALLINN

Eesti Tööstusdisainilahenduse Lehte antakse välja tööstusdisaini kaitse seaduse (jõustunud 11.01.1998) alusel.  
The Estonian Industrial Design Gazette is the official publication of the Estonian Patent Office.  
Published under Industrial Design Protection Law of the Republic of Estonia (coming into force 11 January 1998).  
Date of publication of the data presented in this issue - 16 August 2004.

Patendiameti  
infoosakond  
Toompuiestee 7  
15041 Tallinn  
Tel. 627 7907  
Faks 627 7943  
E-post: Info@epa.ee

The Information Department  
of the Estonian Patent Office  
Toompuiestee 7  
15041 Tallinn, ESTONIA  
Phone +372 627 7907  
Fax +372 627 7943  
E-mail: Info@epa.ee

Levitaja

Eesti Patendiraamatukogu  
Olevimägi 8/10  
10123 Tallinn  
Tel. 641 1248  
Faks 641 1018  
E-post: patent@patentlib.ee

Distributor

Estonian Patent Library  
Olevimägi 8/10  
10123 Tallinn, ESTONIA  
Phone +372 641 1248  
Fax +372 641 1018  
E-mail: patent@patentlib.ee

**SISUKORD**

Andmete identifitseerimise rahvusvahelised numberkoodid (INID-koodid) . . . . .	4
Riikide, teiste ühenduste ja valitsustevaheliste organisatsioonide koodid . . . . .	5
I. REGISTREERITUD TÖÖSTUSDISAINILAHENDUSED . . . . .	6
II. TÖÖSTUSDISAINILAHENDUSE REGISTREERINGU KEHTIVUSE PIKENDAMINE . . . . .	58
III. TÖÖSTUSDISAINILAHENDUSE REGISTREERINGU ANDMETE MUUTMINE . . . . .	-
IV. TÖÖSTUSDISAINILAHENDUSE OMANIKU ÕIGUSTE KASUTUSVALDUSSE ANDMINE . . . . .	-
V. TÖÖSTUSDISAINILAHENDUSE REGISTREERINGU KUSTUTAMINE . . . . .	58
VI. TÖÖSTUSDISAINILAHENDUSE TUNNISTUSE DUPLIKAADI VÄLJASTAMINE . . . . .	-
VII. LOENDID . . . . .	59
Registreeritud tööstusdisainilahenduste süstemaatiline loend . . . . .	59
Registreeritud tööstusdisainilahenduste registreerimistaotluste numbriline loend . . . . .	59
VIII. TÖÖSTUSDISAINIALASED ÕIGUSAKTID JA MUU INFO . . . . .	60
Riiklikus patendivolinike registris registreeritud patendivolinike nimekiri . . . . .	60

**CONTENTS**

Internationally Agreed Numbers for the Identification of Data (INID Codes) . . . . .	4
List of Codes of States, Other Entities and Intergovernmental Organizations . . . . .	5
I. REGISTERED INDUSTRIAL DESIGNS . . . . .	6
II. RENEWAL OF TERM OF INDUSTRIAL DESIGN . . . . .	58
III. CHANGE IN DATA RELATING TO THE REGISTRATION OF INDUSTRIAL DESIGN . . . . .	-
IV. TRANSFER OF RIGHTS OF PROPRIETOR OF INDUSTRIAL DESIGN INTO USUFRUCT. . . . .	-
V. DELETION OF INDUSTRIAL DESIGN REGISTRATION . . . . .	58
VI. ISSUE OF A DUPLICATE OF INDUSTRIAL DESIGN CERTIFICATE . . . . .	-
VII. LISTS . . . . .	59
Systematic List of Registered Industrial Designs . . . . .	59
Numerical List of Registration Applications of Registered Industrial Designs . . . . .	59
VIII. LEGAL ACTS AND INFORMATION. . . . .	60
List of Patent Attorneys, Registered in the Estonian State Register of Patent Attorneys . . . . .	64

**ANDMETE IDENTIFITSEERIMISE  
RAHVUSVAHELISED NUMBERKOODID  
(INID-KOODID)  
WIPO Standard ST.80**

**INTERNATIONALLY AGREED NUMBERS FOR  
THE IDENTIFICATION OF DATA  
(INID CODES)  
WIPO Standard ST.80**

(11) Registreeringu number	(11) Number of the Registration
(15) Registreerimise kuupäev	(15) Date of the Registration
(18) Registreeringu kehtivuse lõppemise kuupäev	(18) Expected expiration date of the registration
(21) Registreerimistaotluse number	(21) Application Number
(22) Registreerimistaotluse esitamise kuupäev	(22) Application Filing Date
(24) Registreeringu kehtivuse alguse kuupäev	(24) Date from which the Industrial Design right has effected
(28) Variantide arv	(28) Number of Industrial Designs included in the application
(30) Prioriteet	(30) Priority
(51) Rahvusvahelise klassifikatsiooni klassi ja alaklassi number	(51) International Classification for Industrial Designs (class and subclass of the Locarno Classification)
(54) Tööstusdisainilahenduse nimetus	(54) Title of the Industrial Design
(55) Tööstusdisainilahenduse reproduktsioon	(55) Reproduction of the Industrial Design
(72) Tööstusdisainilahenduse autor(id)	(72) Author(s) of Industrial Design
(73) Tööstusdisainilahenduse omanik(ud)	(73) Proprietor(s) of Industrial Design
(74) Patendivolinik või ühine esindaja	(74) Patent Attorney or Common Representative

**RIIKIDE, TEISTE ÜHENDUSTE JA VALITSUSTEVAAHELISTE  
ORGANISATSIOONIDE KOODID**

AD	Andorra	DM	Dominica	IT	Itaalia	PL	Poola
AE	Araabia	DO	Dominikaani	JM	Jamaica	PT	Portugal
	Ühendemiraadid		Vabariik	JO	Jordaania	PW	Belau
AF	Afganistan	DZ	Alžeeria	JP	Jaapan	PY	Paraguay
AG	Antigua ja Barbuda	EA	Euraasia	KE	Kenya	QA	Katar
AI	Anguilla		Patendiorganisat-	KG	Kõrgõzstan	RO	Rumeenia
AL	Albaania		sioon (EAPO)	KH	Kambodža	RU	Venemaa
AM	Armeenia	EC	Ecuador	KI	Kiribati	RW	Rwanda
AN	Hollandi Antillid	EE	Eesti	KM	Komoorid	SA	Saudi Araabia
AO	Angola	EG	Egiptus	KN	Saint Kitts ja Nevis	SB	Saalomoni Saared
AP	Aafrika Regionaalne	EH	Lääne-Sahara	KP	Põhja-Korea	SC	Seišellid
	Tööstusomandi Orga-	EM	Siseturu	KR	Lõuna-Korea	SD	Sudaan
	nisatsioon (ARIPO)		Ühtlustamise	KW	Kuveit	SE	Rootsi
AR	Argentina		Amet (kaubamärgid	KY	Kaimanisaared	SG	Singapur
AS	Ameerika Samoa		ja tööstusdisaini-	KZ	Kasahstan	SH	Saint Helena
AT	Austria		lahendused) (OHIM)	LA	Laos	SI	Sloveenia
AU	Austraalia	EP	Euroopa	LB	Liibanon	SK	Slovakkia
AW	Aruba		Patendiamet (EPO)	LC	Saint Lucia	SL	Sierra Leone
AZ	Aserbaidžaan	ER	Eritrea	LI	Liechtenstein	SM	San Marino
BA	Bosnia ja	ES	Hispaania	LK	Sri Lanka	SN	Senegal
	Hertsegovina	ET	Etiopia	LR	Libeeria	SO	Somaalia
BB	Barbados	FI	Soome	LS	Lesotho	SR	Suriname
BD	Bangladesh	FJ	Fidži	LT	Leedu	ST	São Tomé ja Príncipe
BE	Belgia	FK	Falklandi (Malviini)	LU	Luksemburg	SV	El Salvador
BF	Burkina Faso		saared	LV	Läti	SY	Süüria
BG	Bulgaaria	FM	Mikroneesia	LY	Liibüa	SZ	Svaasimaa
BH	Bahrein	FO	Fääri saared	MA	Maroko	TC	Turks ja Caicos
BI	Burundi	FR	Prantsusmaa	MC	Monaco	TD	Tšaad
BJ	Benin	GA	Gabon	MD	Moldova	TG	Togo
BM	Bermuda	GB	Ühendkuningriik	MG	Madagaskar	TH	Tai
BN	Brunei		(Suurbritannia)	MH	Marshalli Saared	TJ	Tadžikistan
BO	Boliivia	GD	Grenada	MK	Makedoonia	TM	Türkmenistan
BR	Brasiilia	GE	Gruusia	ML	Mali	TN	Tuneesia
BS	Bahama	GH	Ghana	MM	Myanmar (Birma)	TO	Tonga
BT	Bhutan	GI	Gibraltar	MN	Mongoolia	TL	Ida-Timor
BV	Bouvet' saar	GL	Gröönimaa	MO	Macao	TR	Türgi
BW	Botswana	GM	Gambia	MP	Põhja-Mariaanid	TT	Trinidad ja Tobago
BX	Beneluxi	GN	Guinea	MR	Mauritaania	TV	Tuvalu
	Kaubamärgiamet	GQ	Ekvatoriaal-Guinea	MS	Montserratt	TW	Taiwan (Hiina provints)
	(BBM) ja Beneluxi	GR	Kreeka	MT	Malta	TZ	Tansaania
	Tööstusdisainilahen-	GS	Lõuna-Georgia ja	MU	Mauritius	UA	Ukraina
	duste Amet (BBDM)		Lõuna-Sandwichi	MV	Maldiiivid	UG	Uganda
			saared	MW	Malawi	US	Ameerika
BY	Valgevene			MX	Mehhiko		Ühendriigid
BZ	Belize	GT	Guatemala	MY	Malaisia	UY	Uruguay
CA	Kanada	GW	Guinea-Bissau	MZ	Mosambiik	UZ	Usbekistan
CF	Kesk-Aafrika	GY	Guyana	NA	Namiibia	VA	Vatikan (Püha Tool)
	Vabariik	HK	Hongkong	NE	Niger	VC	Saint Vincent ja
CG	Kongo	HN	Honduras	NG	Nigeeria		Grenadiinid
CH	Šveits	HR	Horvaatia	NI	Nicaragua	VE	Venezuela
CI	Côte d'Ivoire	HT	Haiti	NL	Holland	VG	Neitsisaared
CK	Cooki saared	HU	Ungari	NO	Norra	VN	Vietnam
CL	Tšiili	IB	Ülemaailmse	NP	Nepal	VU	Vanuatu
CM	Kamerun		Intellektuaalomandi	NR	Nauru	WO	Ülemaailmne
CN	Hiina		Organisatsiooni	NZ	Uus-Meremaa		Intellektuaalomandi
CO	Kolumbia		(WIPO) Rahvus-	OA	Aafrika Intellektuaal-		Organisatsioon
CR	Costa Rica		vaheline Büroo		omandi Organisat-		(WIPO) (Rahvus-
CS	Serbia ja Montenegro	ID	Indoneesia		sioon (OAPI)		vaheline Büroo)
CU	Kuuba	IE	Iiri	OM	Omaan	WS	Samoa
CV	Cabo Verde	IL	Iisrael	PA	Panama	YE	Jeemen
CY	Küpros	IM	Man'i saar	PE	Peruu	ZA	Lõuna-Aafrika Vabariik
CZ	Tšehhi	IN	India	PG	Paapua Uus-Guinea	ZM	Sambia
DE	Saksamaa	IQ	Iraak	PH	Filipiinid	ZR	Zaire
DJ	Djibouti	IR	Iraan	PK	Pakistan	ZW	Zimbabwe
DK	Taani	IS	Island				

## **I. REGISTREERITUD TÖÖSTUSDISAINILAHENDUSED**

Avaldatakse "Tööstusdisaini kaitse seaduse" § 55<sup>1</sup> lõike 7 alusel.

Patendiamet ei ole kontrollinud tööstusdisainilahenduse uudsust ja eristatavust tulenevalt "Tööstusdisaini kaitse seaduse" § 31 lõike 2 punktist 1.

- (11) Registreeringu number: **00934** (51) Klass: **09-07**
- (15) Registreerimise päev: 15.07.2004
- (21) Taotluse number: D200300148
- (22) Esitamise päev: 19.12.2003
- (24) Registreeringu kehtivuse alguse päev: 19.12.2003
- (18) Registreeringu kehtivuse lõppemise päev: 19.12.2008
- (28) Variantide arv: 1
- (72) Autor: Virmantas Rimkus, J. Grušo g. 2-49, LT-3040 Kaunas, LT
- (73) Omanik: Uždaroji akcin., bendrov., "DRUSKININKÄ RASA", Laisv.,s aikšt., 6, LT-4690 Druskininkai, LT
- (74) Patendivolinik või ühine esindaja: Arvo Salumäe

(54) Nimetus: **Pudelikork**

(55) Reproduksioon:

00934-01

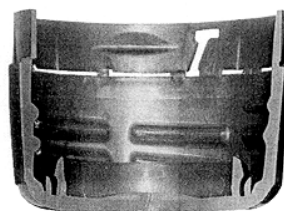
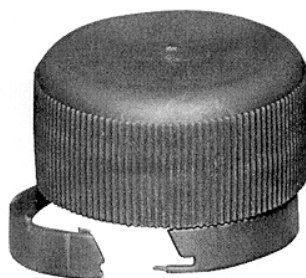
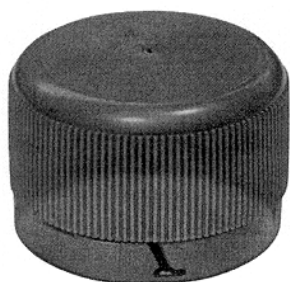



- (11) Registreeringu number: **00935**
- (15) Registreerimise päev: 15.07.2004
- (21) Taotluse number: D200400001
- (22) Esitamise päev: 02.01.2004
- (24) Registreeringu kehtivuse alguse päev: 02.01.2004
- (18) Registreeringu kehtivuse lõppemise päev: 02.01.2009
- (28) Variantide arv: 1
- (72) Autor: *Autori andmeid ei avalikustata*
- (73) Omanik: Veljo Varind, Mooni 93/2-20, 13424 Tallinn, EE

(51) Klass: **12-08**(54) Nimetus: **Sõiduauto "SPECTACLE"**

(55) Reproduksioon:

00935-01

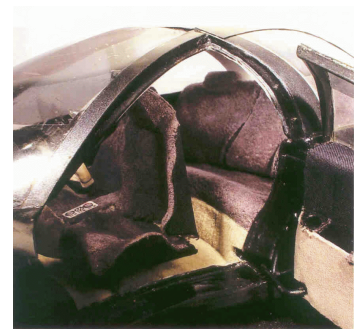
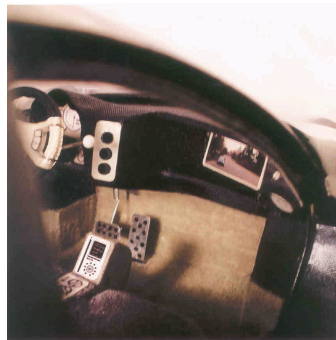
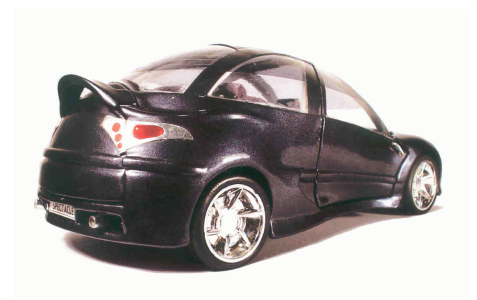

- (11) Registreeringu number: **00936**
- (15) Registreerimise päev: 15.07.2004
- (21) Taotluse number: D200400004
- (22) Esitamise päev: 15.01.2004
- (24) Registreeringu kehtivuse alguse päev: 15.01.2004
- (18) Registreeringu kehtivuse lõppemise päev: 15.01.2009
- (28) Variantide arv: 1
- (72) Autor: Arto Helin, Ruukinmestarintie 12, 02330 Espoo, FI
- (73) Omanik: Tony Schuravleff, Ruukinmestarintie 12, 02330 Espoo, FI
- (74) Patendivolinik või ühine esindaja: Kaie Puur
- (51) Klass: **07-02, 07-99**

(54) Nimetus: **Saunakulp**

(55) Reproduktsoon:

00936-01



- (11) Registreeringu number: **00937** (51) Klass: **14-03**
- (15) Registreerimise päev: 15.07.2004
- (21) Taotluse number: D200400021
- (22) Esitamise päev: 25.02.2004
- (24) Registreeringu kehtivuse alguse päev: 25.02.2004
- (18) Registreeringu kehtivuse lõppemise päev: 25.02.2009
- (28) Variantide arv: 1
- (30) Prioriteediandmed: 29/188,743, 25.08.2003, US
- (72) Autor: Kelley Ann Lee, 543 S. Marengo Avenue # 2, Pasadena, CA 91101, US  
Andrew Gartrell, 20520 Ventura Boulevard # 103, Woodland Hills, California 91364, US
- (73) Omanik: Nokia Corporation, Keilalahdentie 4, FIN-02150 Espoo, FI
- (74) Patendivolinik või ühine esindaja: Kaie Puur

(54) Nimetus: **Käsitelefoni esipaneel**

(55) Reproduktsoon:

00937-01

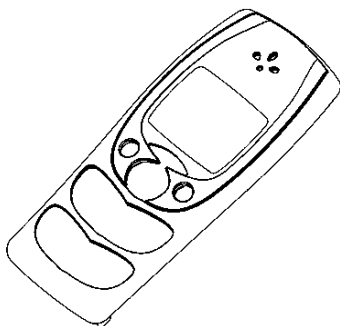
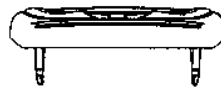
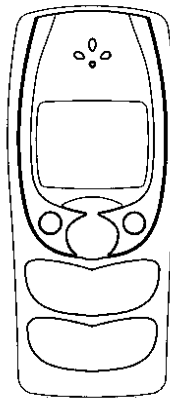
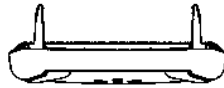

- (11) Registreeringu number: **00938** (51) Klass: **14-03**
- (15) Registreerimise päev: 15.07.2004
- (21) Taotluse number: D200400022
- (22) Esitamise päev: 25.02.2004
- (24) Registreeringu kehtivuse alguse päev: 25.02.2004
- (18) Registreeringu kehtivuse lõppemise päev: 25.02.2009
- (28) Variantide arv: 1
- (30) Prioriteediandmed: 29/188,744, 25.08.2003, US
- (72) Autor: Kelley Ann Lee, 543 S. Marengo Avenue # 2, Pasadena, CA 91101, US  
Andrew Gartrell, 20520 Ventura Boulevard # 103, Woodland Hills, California 91364, US
- (73) Omanik: Nokia Corporation, Keilalahdentie 4, FIN-02150 Espoo, FI
- (74) Patendivolinik või ühine esindaja: Kaie Puur

(54) Nimetus: **Käsitelefon**

(55) Reproduktsoon:

00938-01

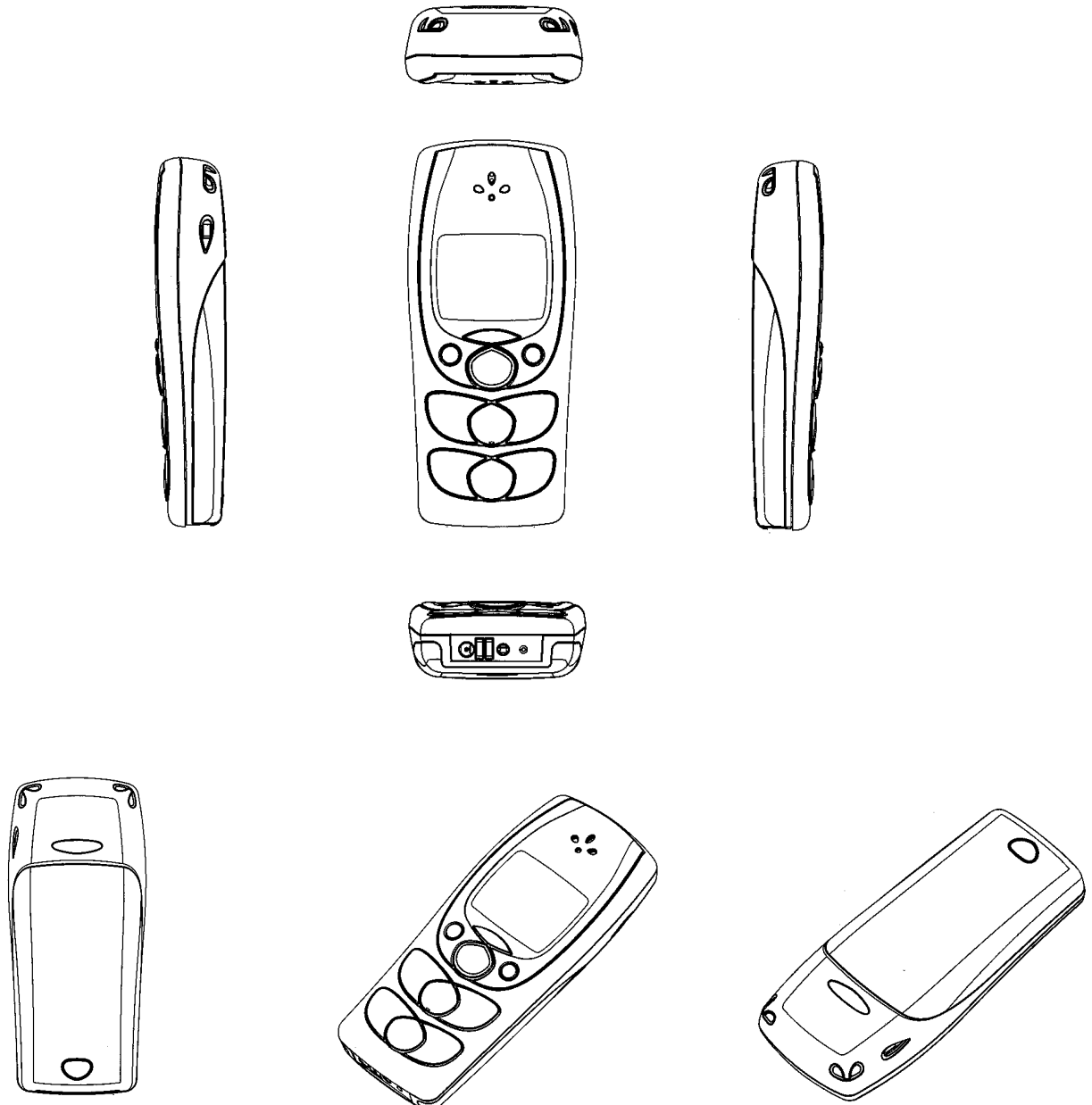

- (11) Registreeringu number: **00939** (51) Klass: **14-03**
- (15) Registreerimise päev: 15.07.2004
- (21) Taotluse number: D200400023
- (22) Esitamise päev: 25.02.2004
- (24) Registreeringu kehtivuse alguse päev: 25.02.2004
- (18) Registreeringu kehtivuse lõppemise päev: 25.02.2009
- (28) Variantide arv: 1
- (30) Prioriteediandmed: 29/188,743, 25.08.2003, US
- (72) Autor: Kelley Ann Lee, 543 S. Marengo Avenue # 2, Pasadena, CA 91101, US  
Andrew Gartrell, 20520 Ventura Boulevard # 103, Woodland Hills, California 91364, US
- (73) Omanik: Nokia Corporation, Keilalahdentie 4, FIN-02150 Espoo, FI
- (74) Patendivolinik või ühine esindaja: Kaie Puur

(54) Nimetus: **Käsitelefoni klaviatuur**

(55) Reproduktsoon:

00939-01

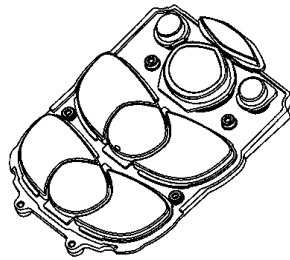
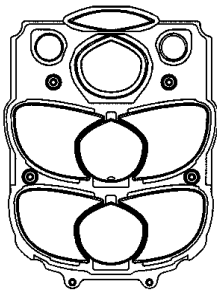

- (11) Registreeringu number: **00940** (51) Klass: **14-03**
- (15) Registreerimise päev: 15.07.2004
- (21) Taotluse number: D200400024
- (22) Esitamise päev: 25.02.2004
- (24) Registreeringu kehtivuse alguse päev: 25.02.2004
- (18) Registreeringu kehtivuse lõppemise päev: 25.02.2009
- (28) Variantide arv: 1
- (30) Prioriteediandmed: 29/188,743, 25.08.2003, US
- (72) Autor: Kelley Ann Lee, 543 S. Marengo Avenue # 2, Pasadena, CA 91101, US  
Andrew Gartrell, 20520 Ventura Boulevard # 103, Woodland Hills, California 91364, US
- (73) Omanik: Nokia Corporation, Keilalahdentie 4, FIN-02150 Espoo, FI
- (74) Patendivolinik või ühine esindaja: Kaie Puur

(54) Nimetus: **Käsitelefoni tagapaneel**

(55) Reproduktsoon:

00940-01

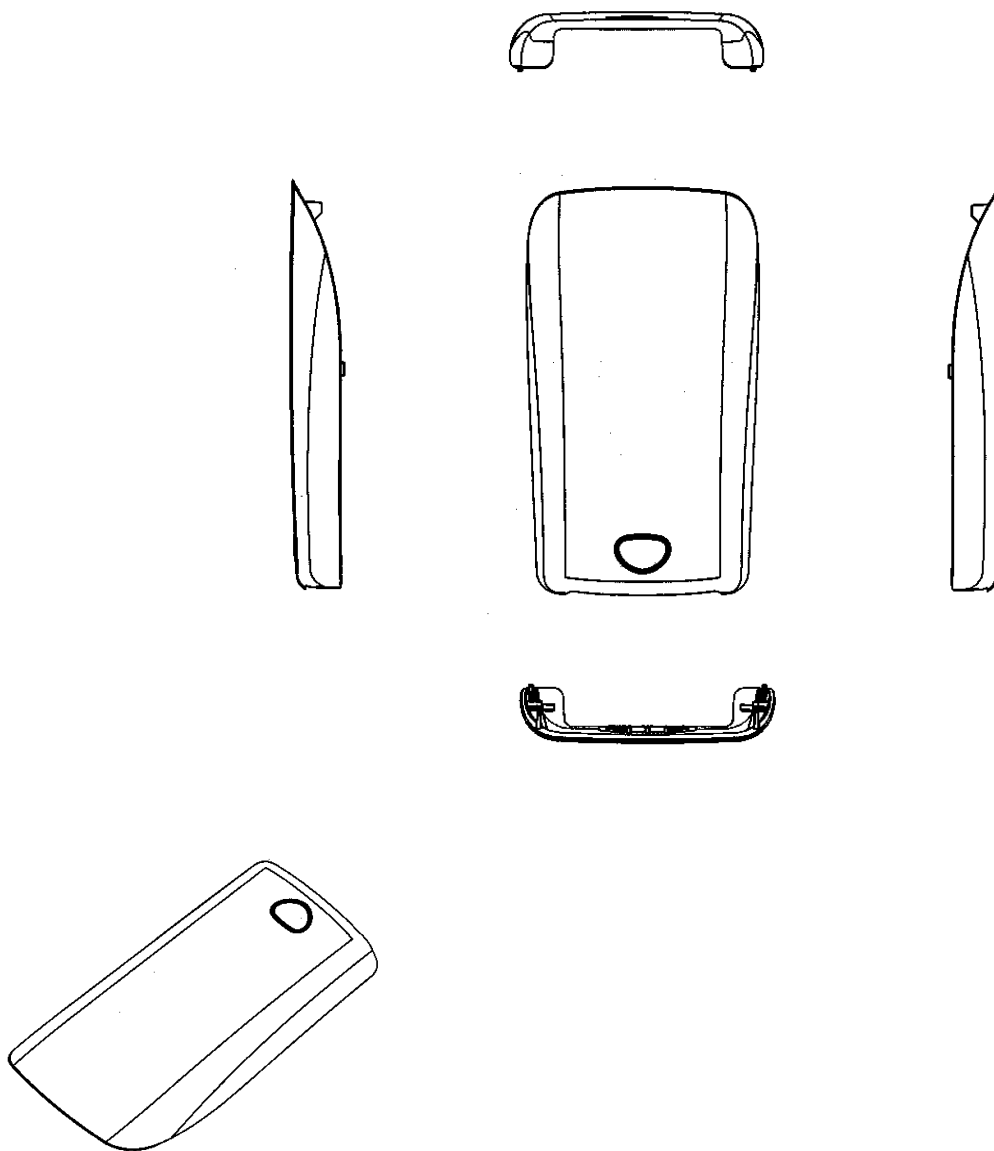

- (11) Registreeringu number: **00941** (51) Klass: **14-03**
- (15) Registreerimise päev: 15.07.2004
- (21) Taotluse number: D200400027
- (22) Esitamise päev: 26.02.2004
- (24) Registreeringu kehtivuse alguse päev: 26.02.2004
- (18) Registreeringu kehtivuse lõppemise päev: 26.02.2009
- (28) Variantide arv: 1
- (30) Prioriteediandmed: 29/188,818, 26.08.2003, US
- (72) Autor: Dimitre Mehandjiysky, 5737 Manton Avenue, Woodland Hills, CA 91367, US
- (73) Omanik: Nokia Corporation, Keilalahdentie 4, FIN-02150 Espoo, FI
- (74) Patendivolinik või ühine esindaja: Jüri Käosaar

(54) Nimetus: **Käsitelefon**

(55) Reproduktsoon:

00941-01

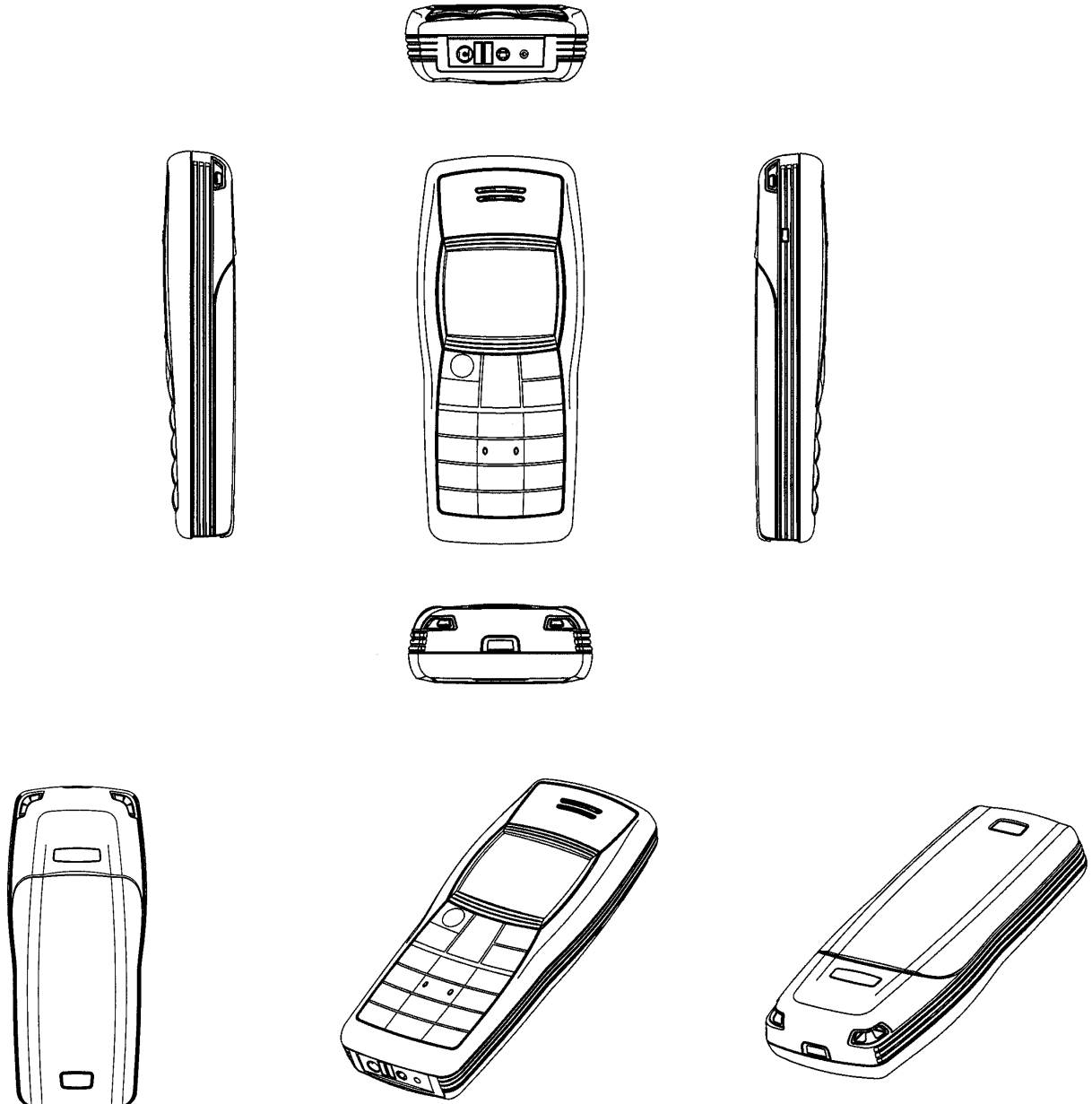

- (11) Registreeringu number: **00942** (51) Klass: **14-03**
- (15) Registreerimise päev: 15.07.2004
- (21) Taotluse number: D200400028
- (22) Esitamise päev: 26.02.2004
- (24) Registreeringu kehtivuse alguse päev: 26.02.2004
- (18) Registreeringu kehtivuse lõppemise päev: 26.02.2009
- (28) Variantide arv: 2
- (30) Prioriteediandmed: 29/188,817, 26.08.2003, US
- (72) Autor: Dimitre Mehandjiysky, 5737 Manton Avenue, Woodland Hills, CA 91367, US
- (73) Omanik: Nokia Corporation, Keilalahdentie 4, FIN-02150 Espoo, FI
- (74) Patendivolinik või ühine esindaja: Jüri Käosaar

(54) Nimetus: **Käsitelefoni esipaneel**

(55) Reproduktsoon:

00942-01

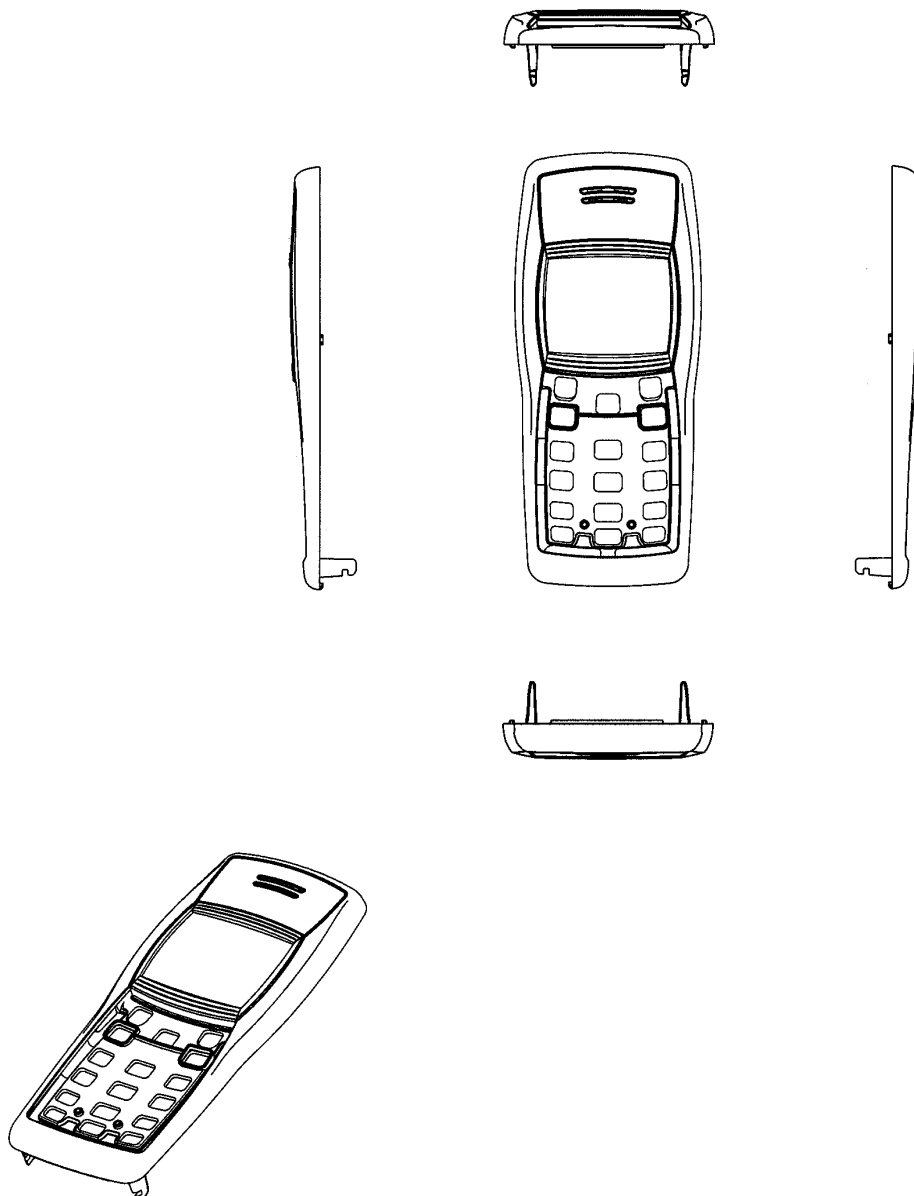



00942-02

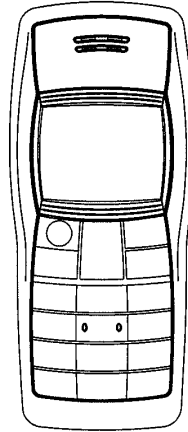
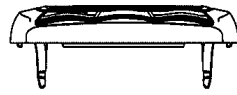

- (11) Registreeringu number: **00943** (51) Klass: **14-03**
- (15) Registreerimise päev: 15.07.2004
- (21) Taotluse number: D200400029
- (22) Esitamise päev: 26.02.2004
- (24) Registreeringu kehtivuse alguse päev: 26.02.2004
- (18) Registreeringu kehtivuse lõppemise päev: 26.02.2009
- (28) Variantide arv: 1
- (30) Prioriteediandmed: 29/188,817, 26.08.2003, US
- (72) Autor: Dimitre Mehandjiysky, 5737 Manton Avenue, Woodland Hills, CA 91367, US
- (73) Omanik: Nokia Corporation, Keilalahdentie 4, FIN-02150 Espoo, FI
- (74) Patendivolinik või ühine esindaja: Jüri Käosaar

(54) Nimetus: **Käsitelefoni klaviatuur**

(55) Reproduktsoon:

00943-01

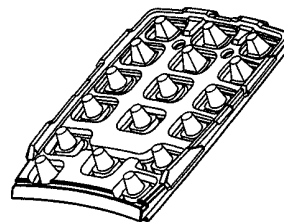
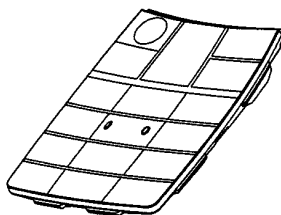
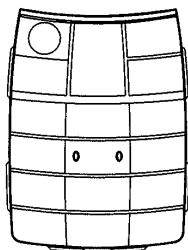

- (11) Registreeringu number: **00944** (51) Klass: **14-03**
- (15) Registreerimise päev: 15.07.2004
- (21) Taotluse number: D200400030
- (22) Esitamise päev: 26.02.2004
- (24) Registreeringu kehtivuse alguse päev: 26.02.2004
- (18) Registreeringu kehtivuse lõppemise päev: 26.02.2009
- (28) Variantide arv: 1
- (30) Prioriteediandmed: 29/188,817, 26.08.2003, US
- (72) Autor: Dimitre Mehandjiysky, 5737 Manton Avenue, Woodland Hills, CA 91367, US
- (73) Omanik: Nokia Corporation, Keilalahdentie 4, FIN-02150 Espoo, FI
- (74) Patendivolinik või ühine esindaja: Jüri Käosaar

(54) Nimetus: **Käsitelefoni tagapaneel**

(55) Reproduktsoon:

00944-01

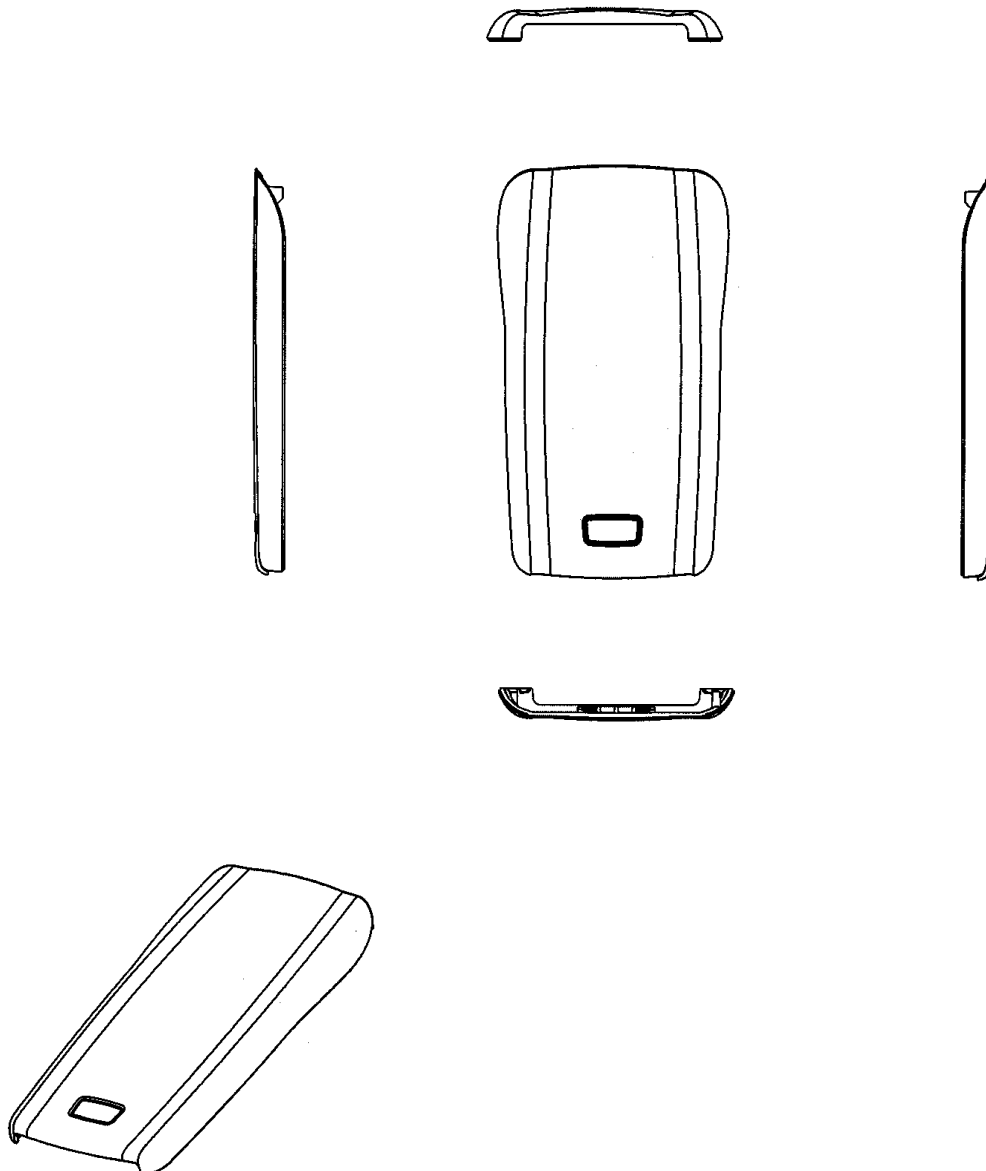

(11) Registreeringu number: **00945**

(51) Klass: **13-02**

(15) Registreerimise päev: 15.07.2004

(21) Taotluse number: D200400034

(22) Esitamise päev: 18.03.2004

(24) Registreeringu kehtivuse alguse päev: 18.03.2004

(18) Registreeringu kehtivuse lõppemise päev: 18.03.2009

(28) Variantide arv: 1

(72) Autor: Jaanus Tamme, Virmalise 9/36, 10131 Tallinn, EE

(73) Omanik: Telemark Hulgi OÜ, Laki 26, 12915 Tallinn, EE

(74) Patendivolinik või ühine esindaja: Ott Moorlat

(54) Nimetus: **Aku "TeleMark"**

(55) Reproduktsoon:

00945-01

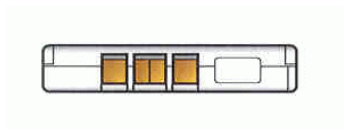
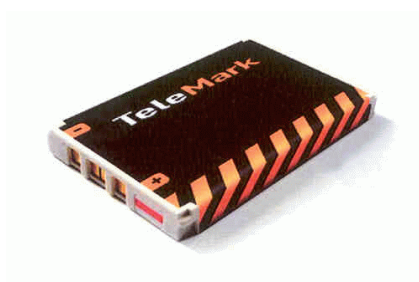

- (11) Registreeringu number: **00946** (51) Klass: **09-01**
- (15) Registreerimise päev: 15.07.2004
- (21) Taotluse number: D200400035
- (22) Esitamise päev: 24.03.2004
- (24) Registreeringu kehtivuse alguse päev: 24.03.2004
- (18) Registreeringu kehtivuse lõppemise päev: 24.03.2009
- (28) Variantide arv: 1
- (30) Prioriteediandmed: f 2003 0086, 24.09.2003, MD
- (72) Autor: Valeriu Mironescu, Bd. Stefan cel Mare nr. 162, MD-2004, Chisinau, MD
- (73) Omanik: Agroindustrial Departament "Moldova-Vin", MD, Bd. Stefan cel Mare nr. 162, MD-2004, Chisinau, MD
- (74) Patendivolinik või ühine esindaja: Toom Pungas

(54) Nimetus: **Pudel**

(55) Reproduktsoon:

00946-01

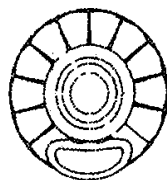

(11) Registreeringu number: **00947**

(51) Klass: **20-03**

(15) Registreerimise päev: 15.07.2004

(21) Taotluse number: D200400036

(22) Esitamise päev: 30.03.2004

(24) Registreeringu kehtivuse alguse päev: 30.03.2004

(18) Registreeringu kehtivuse lõppemise päev: 30.03.2009

(28) Variantide arv: 4

(72) Autor: Franklin D. McMahon, Tartu mnt 18, 10115 Tallinn, EE

(73) Omanik: JCDecaux Unicom Eesti OÜ, Tartu mnt 18, 10115 Tallinn, EE

(74) Patendivolinik või ühine esindaja: Ott Moorlat

(54) Nimetus: **Tagantvalgustatav reklaamkandja**

(55) Reproduksioon:

00947-01

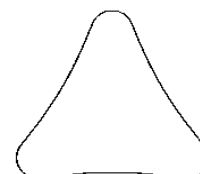
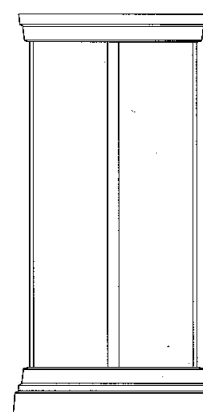
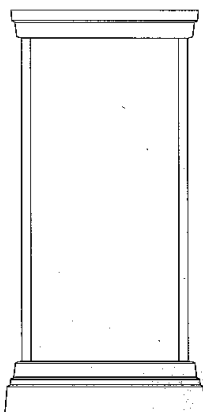
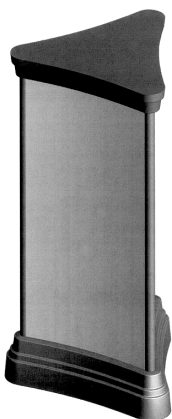

00947-02

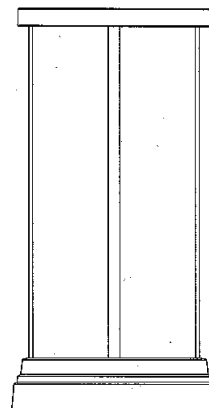
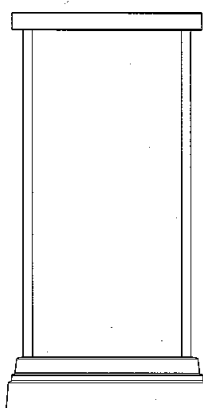
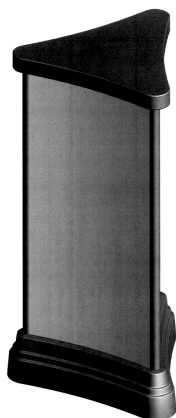

00947-03

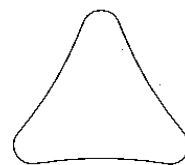
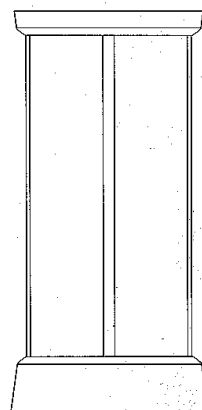
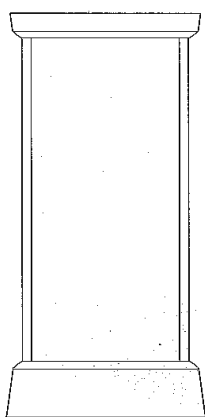
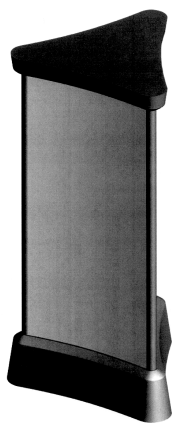

00947-04

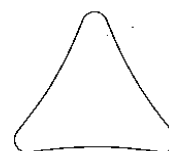
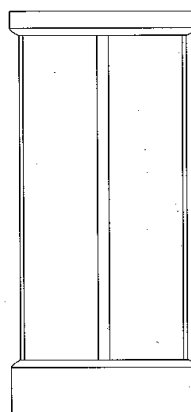
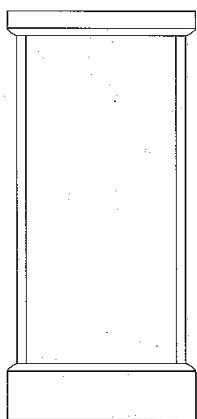
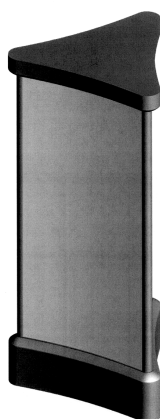

(11) Registreeringu number: **00948**

(51) Klass: **23-02**

(15) Registreerimise päev: 15.07.2004

(21) Taotluse number: D200400037

(22) Esitamise päev: 30.03.2004

(24) Registreeringu kehtivuse  
alguse päev: 30.03.2004

(18) Registreeringu kehtivuse  
lõppemise päev: 30.03.2009

(28) Variantide arv: 1

(72) Autor: Andri Sinka, Kadaka tee 86, 12618 Tallinn, EE

(73) Omanik: NEOQI AS, Kadaka tee 86, 12618 Tallinn, EE

(74) Patendivolinik või ühine esindaja: Ott Moorlat

(54) Nimetus: **Multifunktsionaalne tervisekapsel "HARMONY"**

(55) Reproduktioon:

00948-01

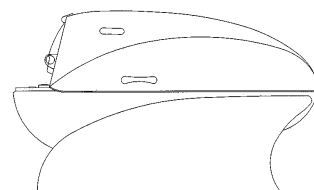
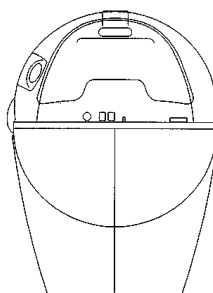
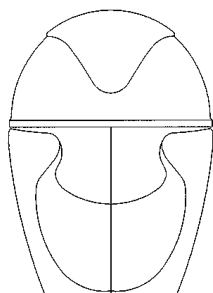
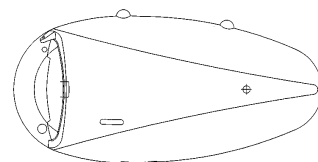
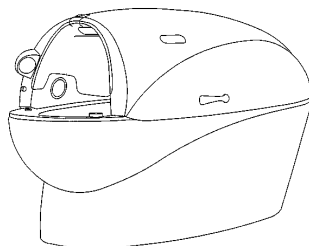
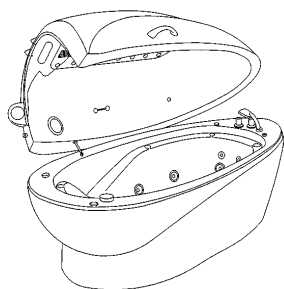



- (11) Registreeringu number: **00949** (51) Klass: **24-01**
- (15) Registreerimise päev: 15.07.2004
- (21) Taotluse number: D200400038
- (22) Esitamise päev: 30.03.2004
- (24) Registreeringu kehtivuse alguse päev: 30.03.2004
- (18) Registreeringu kehtivuse lõppemise päev: 30.03.2009
- (28) Variantide arv: 1
- (72) Autor: Sten Ader, Kadaka tee 86, 12618 Tallinn, EE  
Andri Sinka, Kadaka tee 86, 12618 Tallinn, EE  
NEOQI AS, Kadaka tee 86, 12618 Tallinn, EE
- (73) Omanik: NEOQI AS, Kadaka tee 86, 12618 Tallinn, EE
- (74) Patendivolinik või ühine esindaja: Ott Moorlat

(54) Nimetus: **Füsioteraapiline seade**

(55) Reproduktsoon:

00949-01

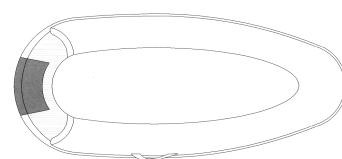
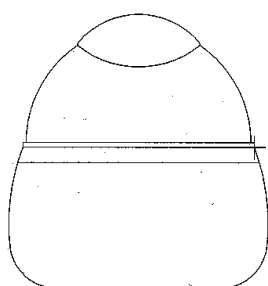
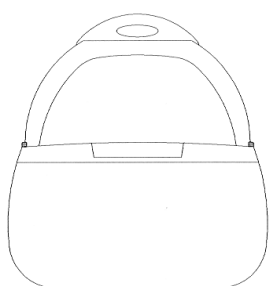
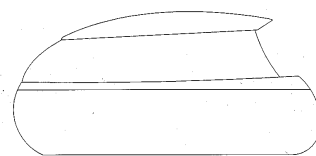
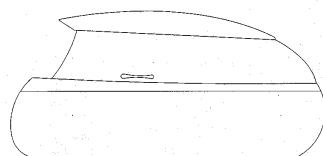
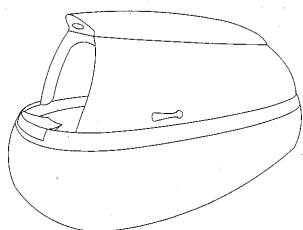

- (11) Registreeringu number: **00950** (51) Klass: **23-02, 24-01**
- (15) Registreerimise päev: 15.07.2004
- (21) Taotluse number: D200400039
- (22) Esitamise päev: 30.03.2004
- (24) Registreeringu kehtivuse alguse päev: 30.03.2004
- (18) Registreeringu kehtivuse lõppemise päev: 30.03.2009
- (28) Variantide arv: 1
- (72) Autor: Sten Ader, Kadaka tee 86, 12618 Tallinn, EE  
Andri Sinka, Kadaka tee 86, 12618 Tallinn, EE  
NEOQI AS, Kadaka tee 86, 12618 Tallinn, EE
- (73) Omanik: NEOQI AS, Kadaka tee 86, 12618 Tallinn, EE
- (74) Patendivolinik või ühine esindaja: Ott Moorlat

(54) Nimetus: **Füsioteraapiline seade "MEDIQ"**

(55) Reproduktsoon:

00950-01

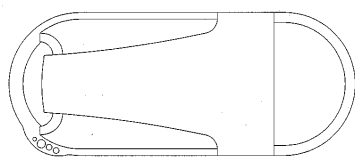
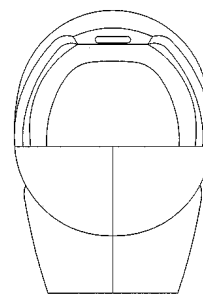
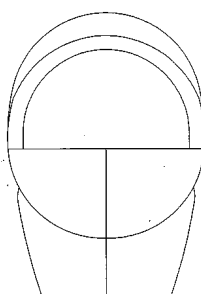
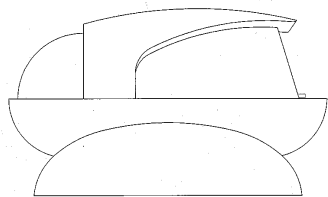
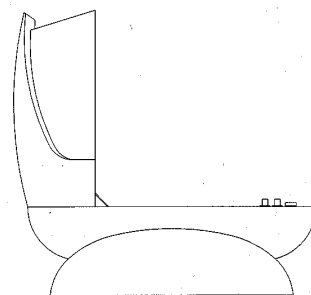
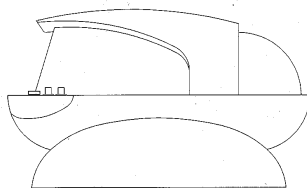
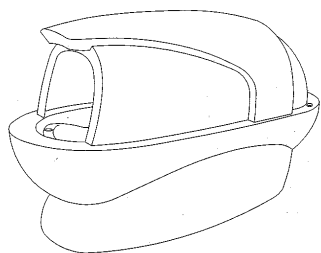

- (11) Registreeringu number: **00951** (51) Klass: **23-02, 24-01**
- (15) Registreerimise päev: 15.07.2004
- (21) Taotluse number: D200400040
- (22) Esitamise päev: 30.03.2004
- (24) Registreeringu kehtivuse alguse päev: 30.03.2004
- (18) Registreeringu kehtivuse lõppemise päev: 30.03.2009
- (28) Variantide arv: 3
- (72) Autor: Sten Ader, Kadaka tee 86, 12618 Tallinn, EE  
Andri Sinka, Kadaka tee 86, 12618 Tallinn, EE  
NEOQI AS, Kadaka tee 86, 12618 Tallinn, EE
- (73) Omanik: NEOQI AS, Kadaka tee 86, 12618 Tallinn, EE
- (74) Patendivolinik või ühine esindaja: Ott Moorlat

(54) Nimetus: **Füsioteraapiline seade "MEDIQ"**

(55) Reproduktioon:

00951-01

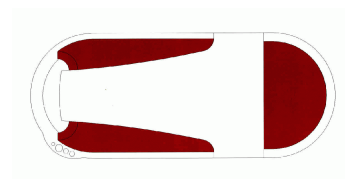
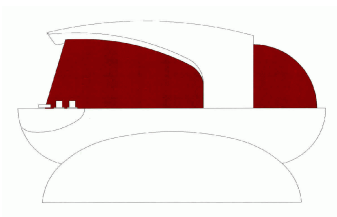
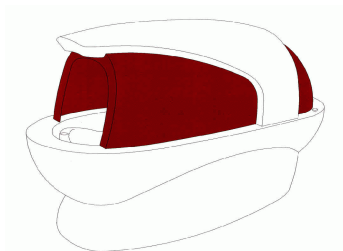

00951-02

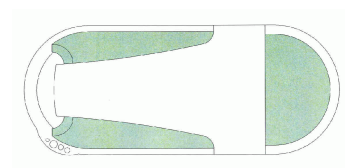
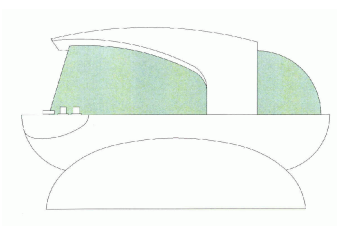
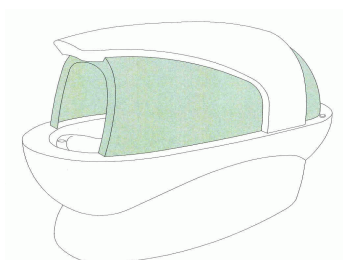

00951-03

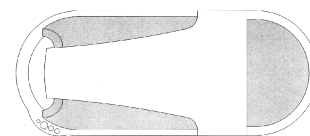
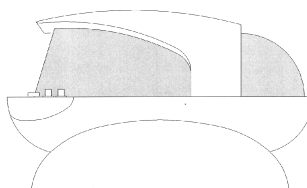
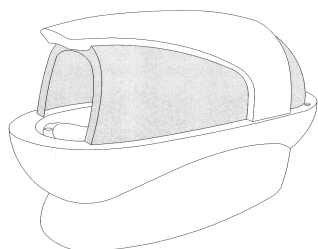

- (11) Registreeringu number: **00952** (51) Klass: **24-01**
- (15) Registreerimise päev: 15.07.2004
- (21) Taotluse number: D200400041
- (22) Esitamise päev: 30.03.2004
- (24) Registreeringu kehtivuse alguse päev: 30.03.2004
- (18) Registreeringu kehtivuse lõppemise päev: 30.03.2009
- (28) Variantide arv: 1
- (72) Autor: Sten Ader, Kadaka tee 86, 12618 Tallinn, EE  
Andri Sinka, Kadaka tee 86, 12618 Tallinn, EE  
NEOQI AS, Kadaka tee 86, 12618 Tallinn, EE
- (73) Omanik: NEOQI AS, Kadaka tee 86, 12618 Tallinn, EE
- (74) Patendivolinik või ühine esindaja: Ott Moorlat

(54) Nimetus: **Füsioteraapiline seade**

(55) Reproduktsoon:

00952-01

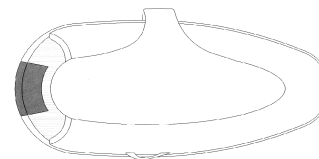
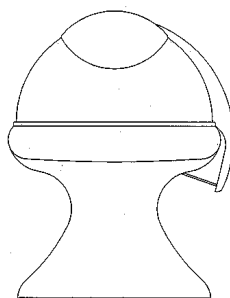
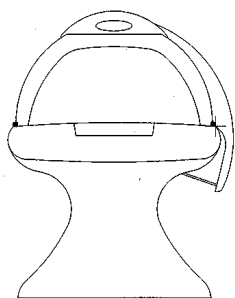
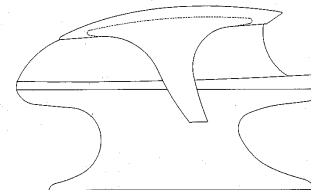
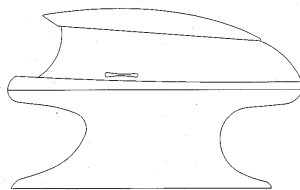
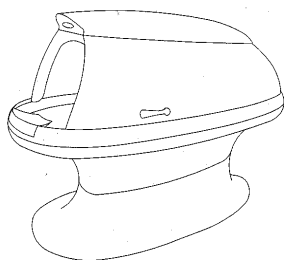

- (11) Registreeringu number: **00953** (51) Klass: **24-01**
- (15) Registreerimise päev: 15.07.2004
- (21) Taotluse number: D200400042
- (22) Esitamise päev: 30.03.2004
- (24) Registreeringu kehtivuse alguse päev: 30.03.2004
- (18) Registreeringu kehtivuse lõppemise päev: 30.03.2009
- (28) Variantide arv: 3
- (72) Autor: Sten Ader, Kadaka tee 86, 12618 Tallinn, EE  
Andri Sinka, Kadaka tee 86, 12618 Tallinn, EE  
NEOQI AS, Kadaka tee 86, 12618 Tallinn, EE
- (73) Omanik: NEOQI AS, Kadaka tee 86, 12618 Tallinn, EE
- (74) Patendivolinik või ühine esindaja: Ott Moorlat

(54) Nimetus: **Füsioteraapiline seade**

(55) Reproduktsoon:

00953-01

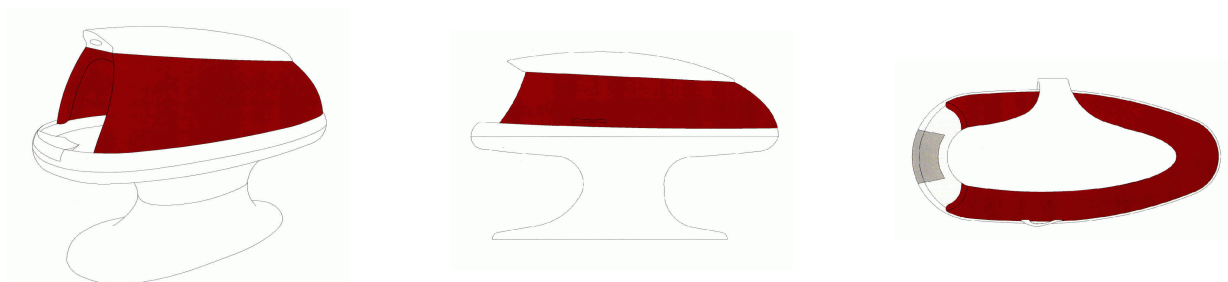

00953-02

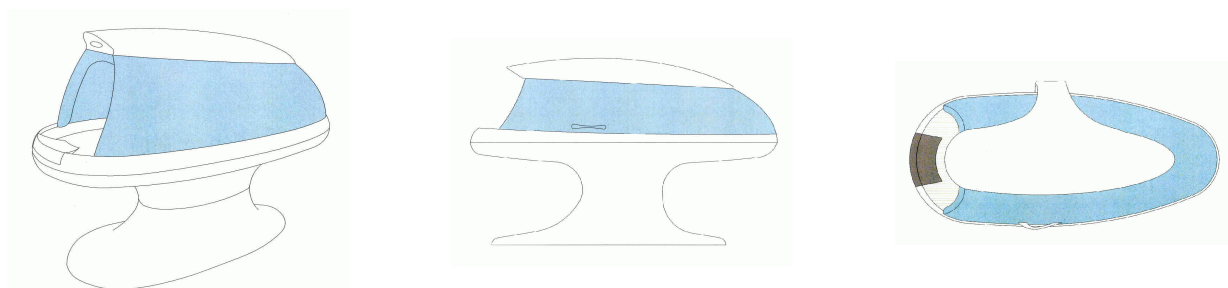

00953-03

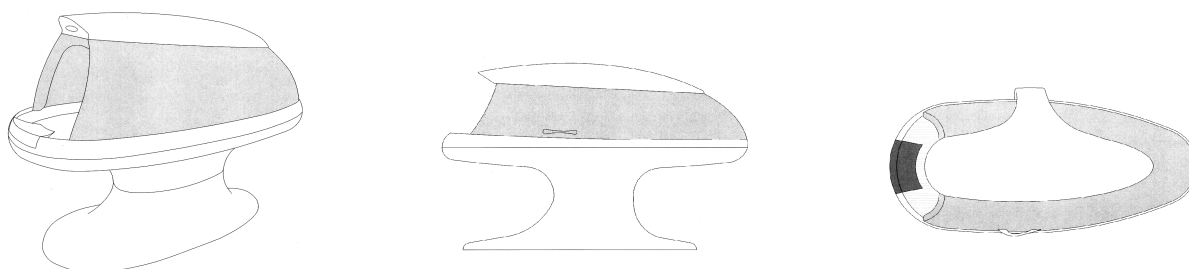

- (11) Registreeringu number: **00954** (51) Klass: **24-01**
- (15) Registreerimise päev: 15.07.2004
- (21) Taotluse number: D200400043
- (22) Esitamise päev: 30.03.2004
- (24) Registreeringu kehtivuse alguse päev: 30.03.2004
- (18) Registreeringu kehtivuse lõppemise päev: 30.03.2009
- (28) Variantide arv: 1
- (72) Autor: Sten Ader, Kadaka tee 86, 12618 Tallinn, EE  
Andri Sinka, Kadaka tee 86, 12618 Tallinn, EE  
NEOQI AS, Kadaka tee 86, 12618 Tallinn, EE
- (73) Omanik: NEOQI AS, Kadaka tee 86, 12618 Tallinn, EE
- (74) Patendivolinik või ühine esindaja: Ott Moorlat

(54) Nimetus: **Füsioteraapiline seade**

(55) Reproduktsoon:

00954-01

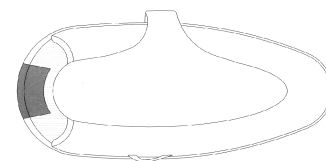
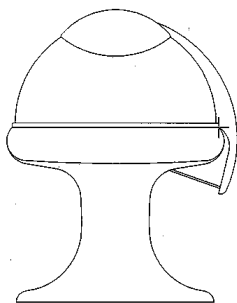
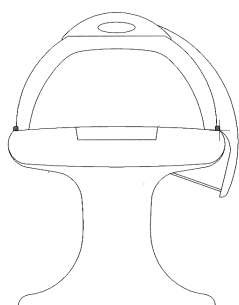
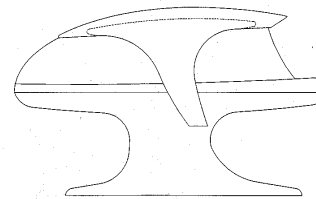
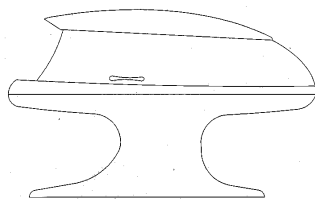
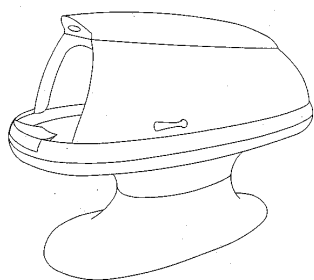

- (11) Registreeringu number: **00955** (51) Klass: **14-03**
- (15) Registreerimise päev: 15.07.2004
- (21) Taotluse number: D200400044
- (22) Esitamise päev: 31.03.2004
- (24) Registreeringu kehtivuse alguse päev: 31.03.2004
- (18) Registreeringu kehtivuse lõppemise päev: 31.03.2009
- (28) Variantide arv: 1
- (30) Prioriteediandmed: M20030251, 23.10.2003, FI
- (72) Autor: Aaron Moss, 42 Gollongwood, Farnborough, Hants, GU14 6GL, GB
- (73) Omanik: Nokia Corporation, Keilalahdentie 4, FIN-02150 Espoo, FI
- (74) Patendivolinik või ühine esindaja: Kaie Puur

(54) Nimetus: **Käsitelefoni klaviatuur**

(55) Reproduksioon:

00955-01

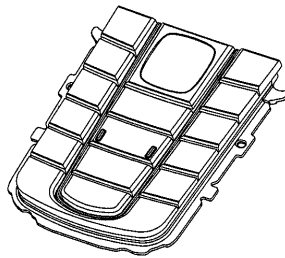
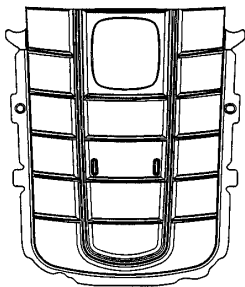

- (11) Registreeringu number: **00956**
- (15) Registreerimise päev: 15.07.2004
- (21) Taotluse number: D200400045
- (22) Esitamise päev: 31.03.2004
- (24) Registreeringu kehtivuse alguse päev: 31.03.2004
- (18) Registreeringu kehtivuse lõppemise päev: 31.03.2009
- (28) Variantide arv: 1
- (30) Prioriteediandmed: M20030251, 23.10.2003, FI
- (72) Autor: Aaron Moss, 42 Gollongwood, Farnborough, Hants, GU14 6GL, GB
- (73) Omanik: Nokia Corporation, Keilalahdentie 4, FIN-02150 Espoo, FI
- (74) Patendivolinik või ühine esindaja: Kaie Puur

(51) Klass: **14-03**

(54) Nimetus: **Käsitelefoni tagapaneel**

(55) Reproduktsoon:

00956-01

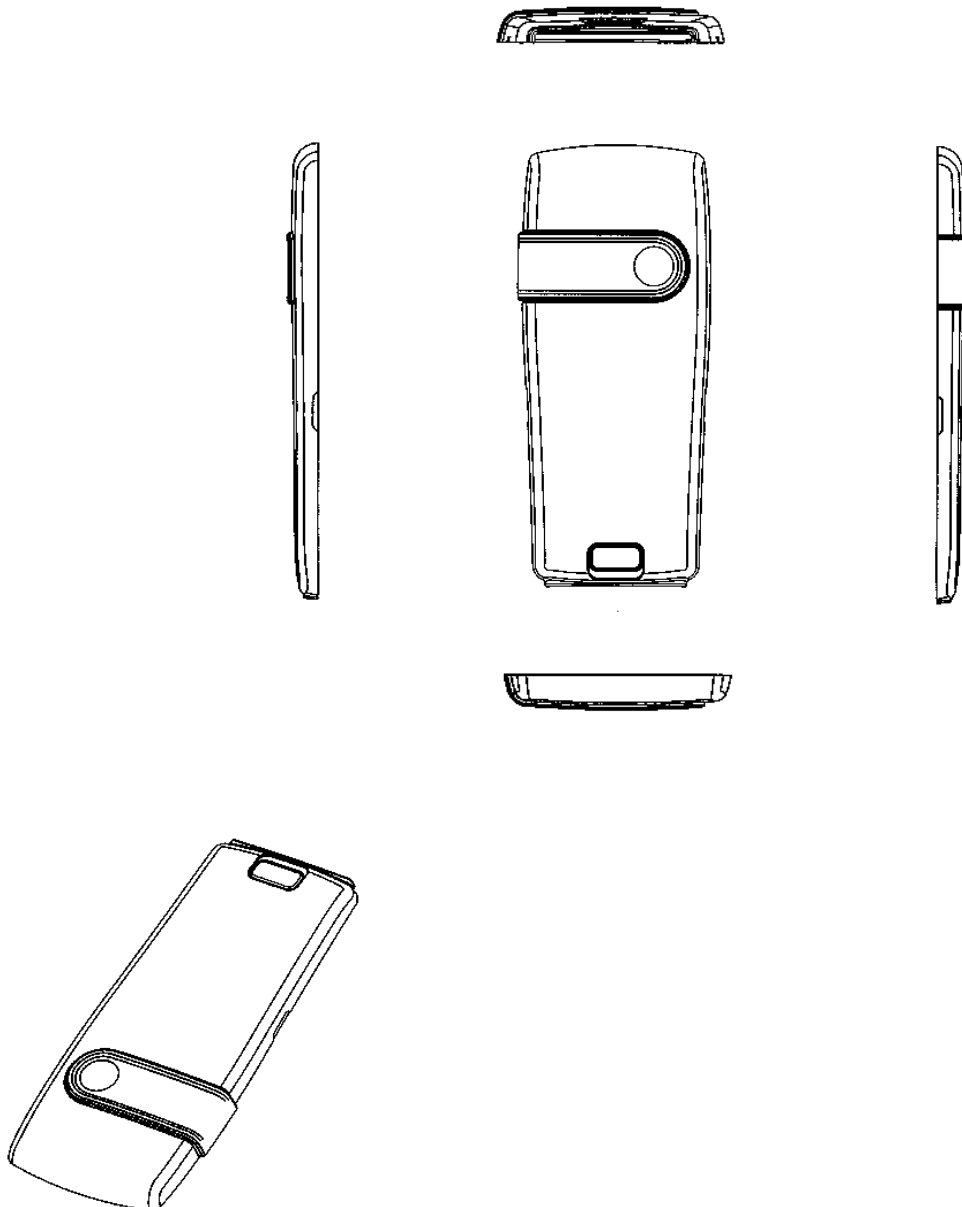



- (11) Registreeringu number: **00957**
- (15) Registreerimise päev: 15.07.2004
- (21) Taotluse number: D200400046
- (22) Esitamise päev: 31.03.2004
- (24) Registreeringu kehtivuse alguse päev: 31.03.2004
- (18) Registreeringu kehtivuse lõppemise päev: 31.03.2009
- (28) Variantide arv: 2
- (30) Prioriteediandmed: M20030251, 23.10.2003, FI
- (72) Autor: Aaron Moss, 42 Gollongwood, Farnborough, Hants, GU14 6GL, GB
- (73) Omanik: Nokia Corporation, Keilalahdentie 4, FIN-02150 Espoo, FI
- (74) Patendivolinik või ühine esindaja: Kaie Puur

(51) Klass: 14-03

(54) Nimetus: **Käsitelefoni esiosa/esipaneel**

(55) Reproduktsoon:

00957-01

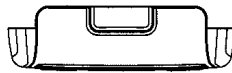
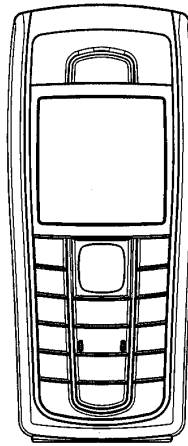

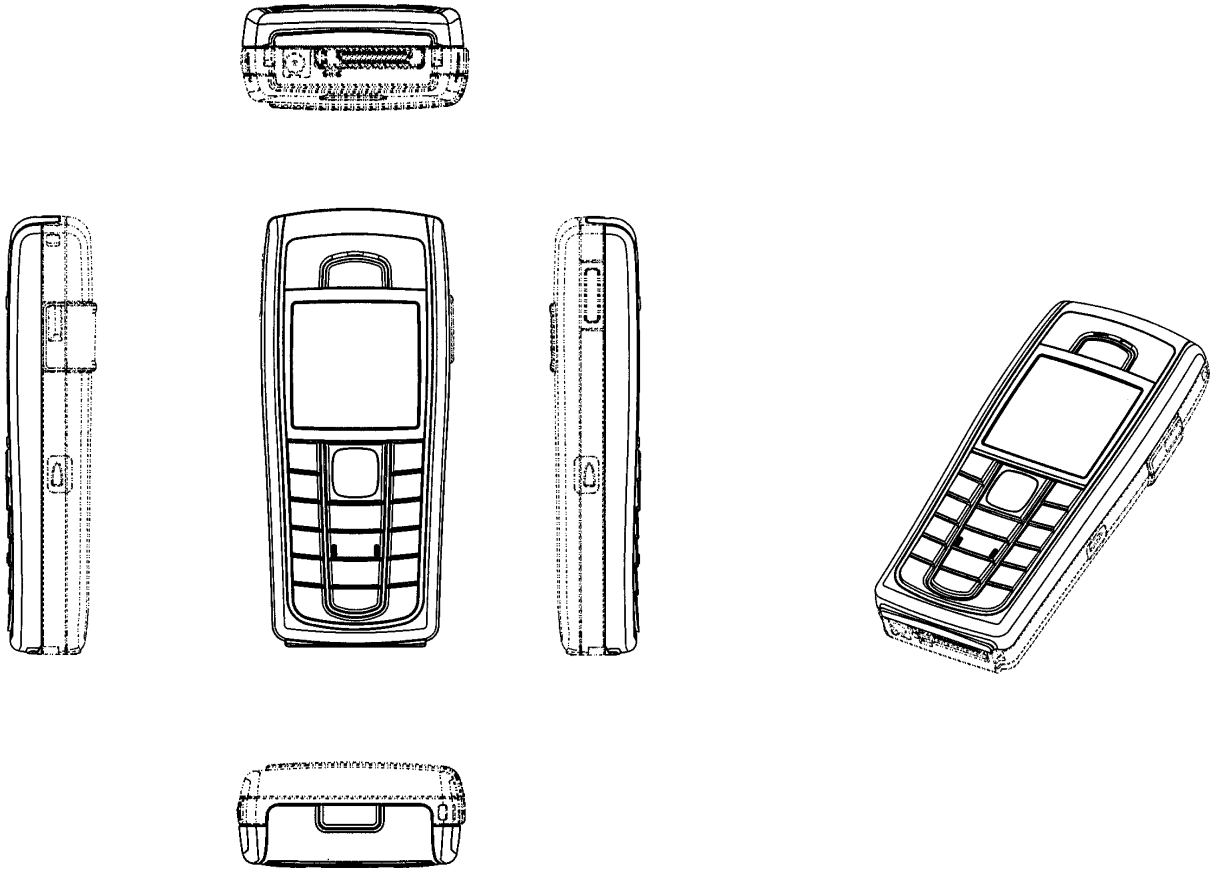

00957-02

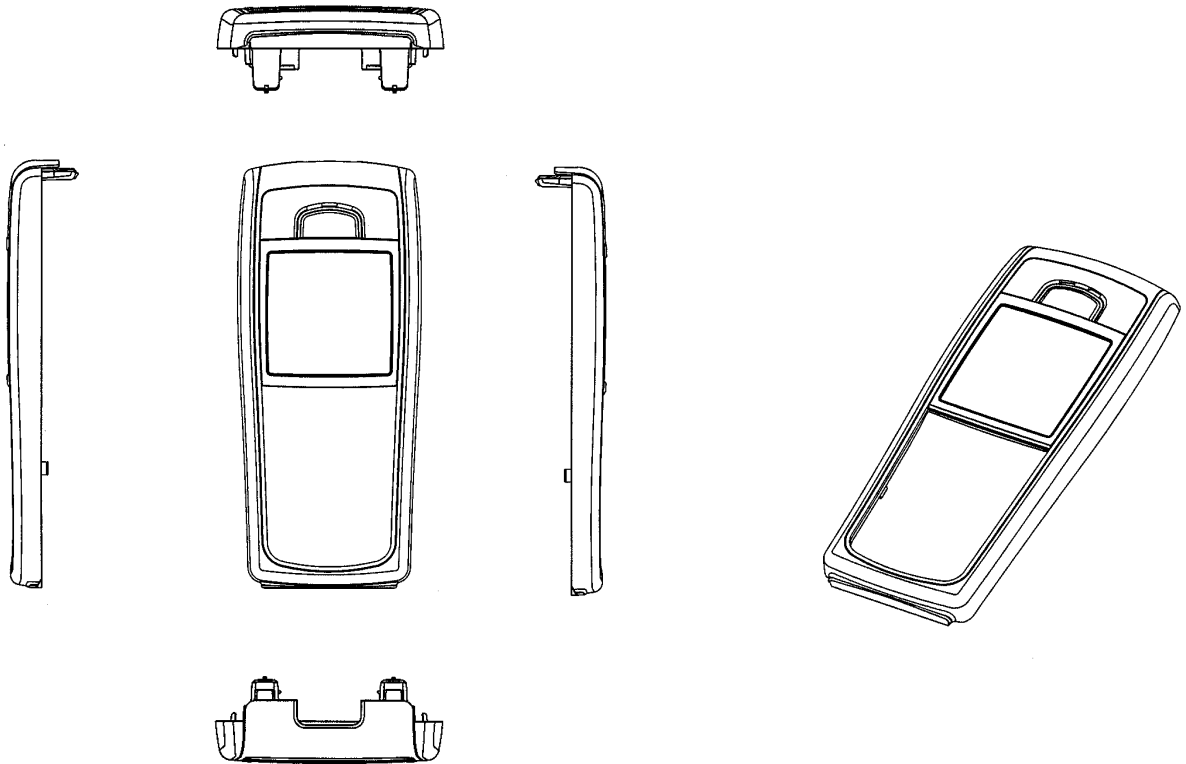

(11) Registreeringu number: **00958**

(51) Klass: **14-03**

(15) Registreerimise päev: 15.07.2004

(21) Taotluse number: D200400047

(22) Esitamise päev: 31.03.2004

(24) Registreeringu kehtivuse alguse päev: 31.03.2004

(18) Registreeringu kehtivuse lõppemise päev: 31.03.2009

(28) Variantide arv: 1

(30) Prioriteediandmed: M20030251, 23.10.2003, FI

(72) Autor: Aaron Moss, 42 Gollongwood, Farnborough, Hants, GU14 6GL, GB

(73) Omanik: Nokia Corporation, Keilalahdentie 4, FIN-02150 Espoo, FI

(74) Patendivolinik või ühine esindaja: Kaie Puur

(54) Nimetus: **Käsitelefon**

(55) Reproduktsoon:

00958-01

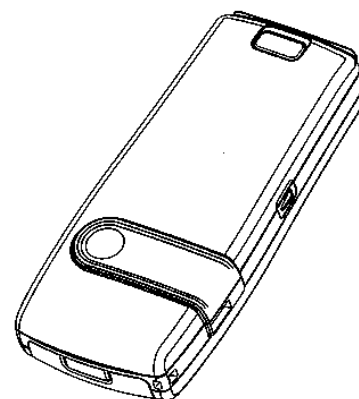
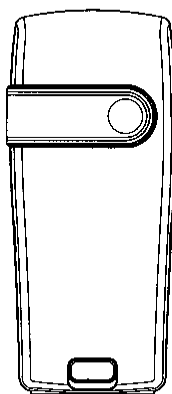
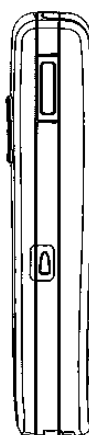
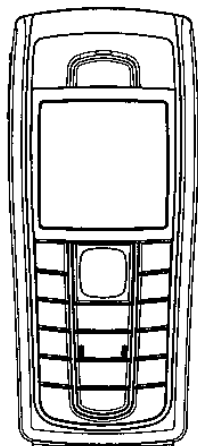
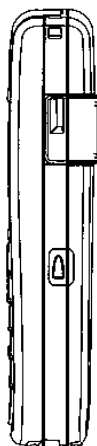

- (11) Registreeringu number: **00959** (51) Klass: **09-03**
- (15) Registreerimise päev: 15.07.2004
- (21) Taotluse number: D200400048
- (22) Esitamise päev: 20.04.2004
- (24) Registreeringu kehtivuse alguse päev: 20.04.2004
- (18) Registreeringu kehtivuse lõppemise päev: 20.04.2009
- (28) Variantide arv: 1
- (72) Autor: Hwa-Kyung Lee, c/o 30-10 Munbae-Dong, Yongsan-Ku, Seoul, KR
- (73) Omanik: ORION Corporation, 30-10 Munbae-Dong, Yongsan-Ku, Seoul, KR
- (74) Patendivolinik või ühine esindaja: Juta-Maris Uustalu
- (54) Nimetus: **Maiustuste pakkekarp**
- (55) Reproduktsoon:
- 00959-01



- (11) Registreeringu number: **00960** (51) Klass: **09-03**
- (15) Registreerimise päev: 15.07.2004
- (21) Taotluse number: D200400049
- (22) Esitamise päev: 20.04.2004
- (24) Registreeringu kehtivuse alguse päev: 20.04.2004
- (18) Registreeringu kehtivuse lõppemise päev: 20.04.2009
- (28) Variantide arv: 1
- (72) Autor: Hwa-Kyung Lee, c/o 30-10 Munbae-Dong, Yongsan-Ku, Seoul, KR
- (73) Omanik: ORION Corporation, 30-10 Munbae-Dong, Yongsan-Ku, Seoul, KR
- (74) Patendivolinik või ühine esindaja: Juta-Maris Uustalu
- (54) Nimetus: **Maiustuste pakkekarp**

(55) Reproduktsoon:

00960-01

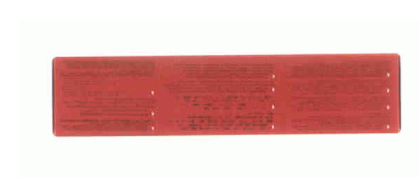

- (11) Registreeringu number: **00961** (51) Klass: **09-03**
- (15) Registreerimise päev: 15.07.2004
- (21) Taotluse number: D200400050
- (22) Esitamise päev: 20.04.2004
- (24) Registreeringu kehtivuse alguse päev: 20.04.2004
- (18) Registreeringu kehtivuse lõppemise päev: 20.04.2009
- (28) Variantide arv: 1
- (72) Autor: Hwa-Kyung Lee, c/o 30-10 Munbae-Dong, Yongsan-Ku, Seoul, KR
- (73) Omanik: ORION Corporation, 30-10 Munbae-Dong, Yongsan-Ku, Seoul, KR
- (74) Patendivolinik või ühine esindaja: Juta-Maris Uustalu
- (54) Nimetus: **Maiustuste pakkekarp**
- (55) Reproduksioon:
- 00961-01



- (11) Registreeringu number: **00962** (51) Klass: **09-03**
- (15) Registreerimise päev: 15.07.2004
- (21) Taotluse number: D200400051
- (22) Esitamise päev: 20.04.2004
- (24) Registreeringu kehtivuse alguse päev: 20.04.2004
- (18) Registreeringu kehtivuse lõppemise päev: 20.04.2009
- (28) Variantide arv: 1
- (72) Autor: Hwa-Kyung Lee, c/o 30-10 Munbae-Dong, Yongsan-Ku, Seoul, KR
- (73) Omanik: ORION Corporation, 30-10 Munbae-Dong, Yongsan-Ku, Seoul, KR
- (74) Patendivolinik või ühine esindaja: Juta-Maris Uustalu
- (54) Nimetus: **Maiustuste pakkekarp**

(55) Reproduktsoon:

00962-01

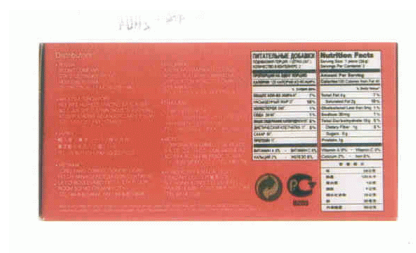
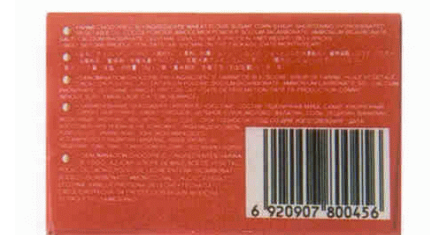
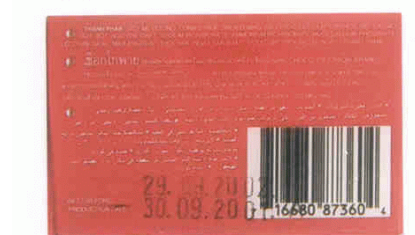

- (11) Registreeringu number: **00963**
- (15) Registreerimise päev: 15.07.2004
- (21) Taotluse number: D200400053
- (22) Esitamise päev: 21.04.2004
- (24) Registreeringu kehtivuse alguse päev: 21.04.2004
- (18) Registreeringu kehtivuse lõppemise päev: 21.04.2009
- (28) Variantide arv: 1
- (30) Prioriteediandmed: M20030251, 23.10.2003, FI
- (72) Autor: Nora Brelo, Pyssysepantie 8, 90800 Oulu, FI
- (73) Omanik: Nokia Corporation, Keilalahdentie 4, FIN-02150 Espoo, FI
- (74) Patendivolinik või ühine esindaja: Kaie Puur

(51) Klass: 14-03, 14-02, 14-01

(54) Nimetus: **Meediaseade**

(55) Reproduktsoon:

00963-01

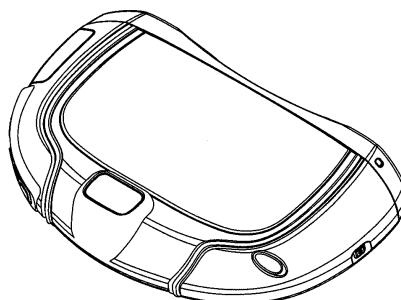
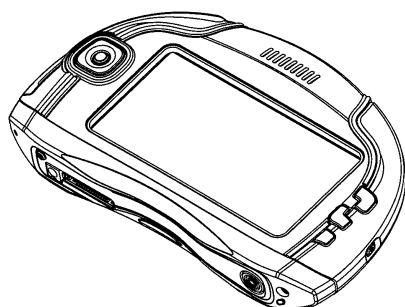
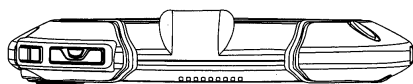
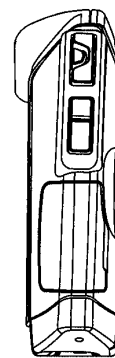
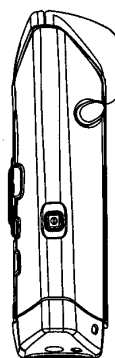
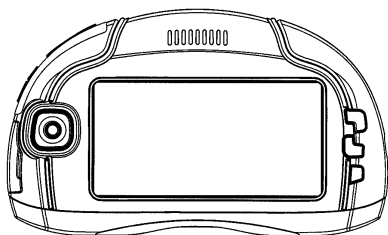
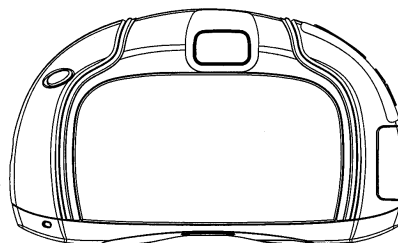



- (11) Registreeringu number: **00964**
- (15) Registreerimise päev: 15.07.2004
- (21) Taotluse number: D200400054
- (22) Esitamise päev: 27.04.2004
- (24) Registreeringu kehtivuse alguse päev: 27.04.2004
- (18) Registreeringu kehtivuse lõppemise päev: 27.04.2009
- (28) Variantide arv: 1
- (30) Prioriteediandmed: M20030253, 27.10.2003, FI
- (72) Autor: Emma Hagman, Läntinen Pitkätatu 29 B 24, 20100 Turku, FI  
Mika Kanninen, Monolantie 1, 21500 Piikkiö, FI
- (73) Omanik: Nokia Corporation, Keilalahdentie 4, FIN-02150 Espoo, FI
- (74) Patendivolinik või ühine esindaja: Jüri Käosaar

(51) Klass: **13-02**(54) Nimetus: **Aku**

(55) Reproduktsoon:

00964-01

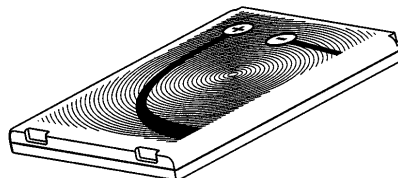
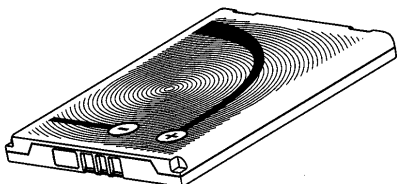
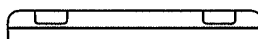
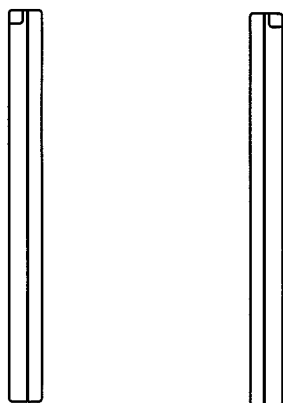
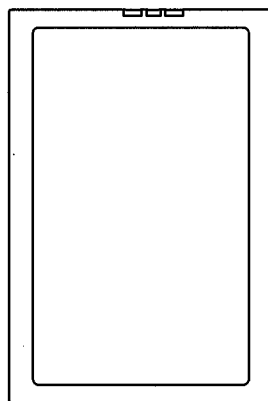

- (11) Registreeringu number: **00965** (51) Klass: **14-03**
- (15) Registreerimise päev: 15.07.2004
- (21) Taotluse number: D200400052
- (22) Esitamise päev: 20.04.2004
- (24) Registreeringu kehtivuse alguse päev: 20.04.2004
- (18) Registreeringu kehtivuse lõppemise päev: 20.04.2009
- (28) Variantide arv: 1
- (30) Prioriteediandmed: 29/192,299, 23.10.2003, US
- (72) Autor: Duncan Burns, #203 18645 Hatteras St., Tarzana, CA 91356, US  
Jamie Langford, 3404 Parr Road, Grapevine, Texas 76051, US  
Tanja Finkbeiner, 40B Strawberry Hill Road, Twickenham, Middlesex TW1 4PU, GB
- (73) Omanik: Nokia Corporation, Keilalahdentie 4, FIN-02150 Espoo, FI
- (74) Patendivolinik või ühine esindaja: Kaie Puur

(54) Nimetus: **Käsitelefon**

(55) Reproduktsoon:

00965-01

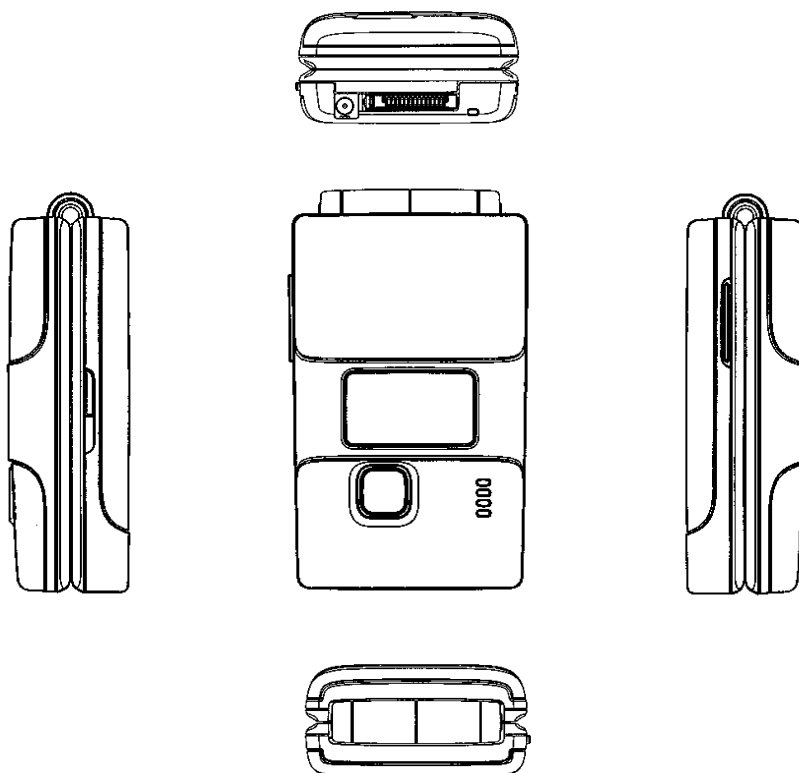

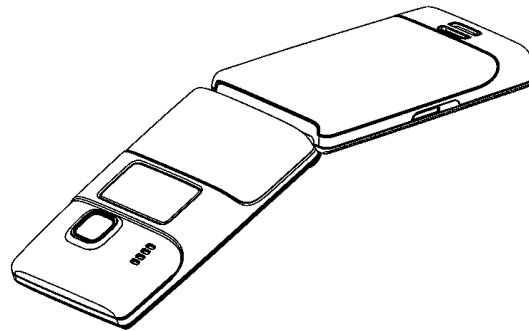
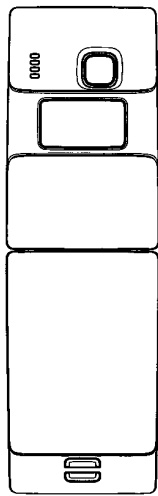
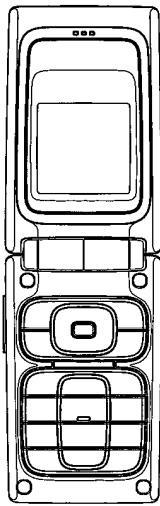
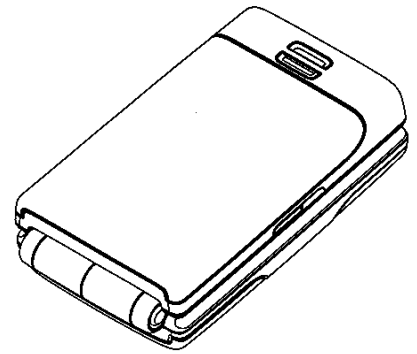
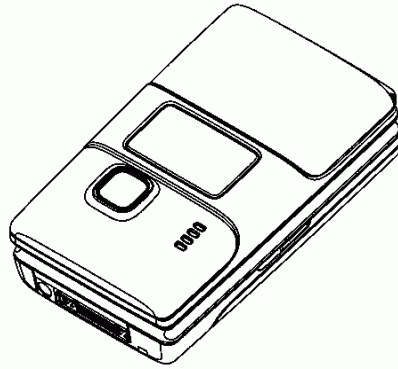
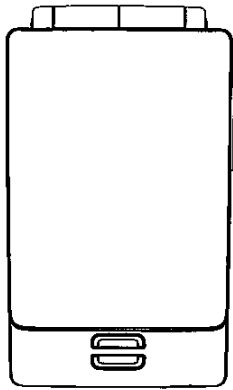

(11) Registreeringu number: **00966**

(51) Klass: **14-03**

(15) Registreerimise päev: 15.07.2004

(21) Taotluse number: D200400061

(22) Esitamise päev: 11.05.2004

(24) Registreeringu kehtivuse alguse päev: 11.05.2004

(18) Registreeringu kehtivuse lõppemise päev: 11.05.2009

(28) Variantide arv: 1

(30) Prioriteediandmed: M20030265, 11.11.2003, FI

(72) Autor: Heikki Kangasmaa, Maurinkatu 14 D 42, 00170 Helsinki, FI

(73) Omanik: Nokia Corporation, Keilalahdentie 4, FIN-02150 Espoo, FI

(74) Patendivolinik või ühine esindaja: Kaie Puur

(54) Nimetus: **Käsitelefon**

(55) Reproduktsoon:

00966-01

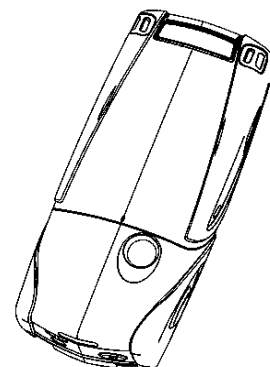
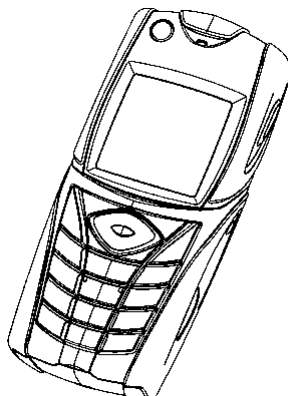
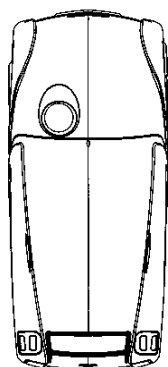
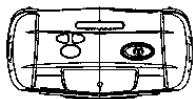
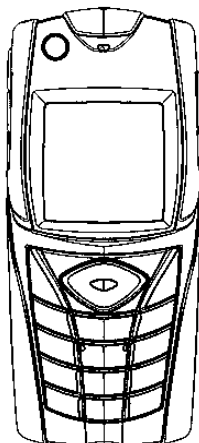
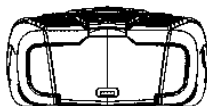

- (11) Registreeringu number: **00967**
- (15) Registreerimise päev: 15.07.2004
- (21) Taotluse number: D200400063
- (22) Esitamise päev: 11.05.2004
- (24) Registreeringu kehtivuse alguse päev: 11.05.2004
- (18) Registreeringu kehtivuse lõppemise päev: 11.05.2009
- (28) Variantide arv: 1
- (30) Prioriteediandmed: M20030265, 11.11.2003, FI
- (72) Autor: Heikki Kangasmaa, Maurinkatu 14 D 42, 00170 Helsinki, FI  
Kati Björninen, Lönnrotinkatu 45 A 35, 00180 Helsinki, FI  
Nokia Corporation, Keilalahdentie 4, FIN-02150 Espoo, FI
- (73) Omanik: Nokia Corporation, Keilalahdentie 4, FIN-02150 Espoo, FI
- (74) Patendivolinik või ühine esindaja: Kaie Puur

(51) Klass: 14-03

(54) Nimetus: **Käsitelefon**

(55) Reproduktsoon:

00967-01

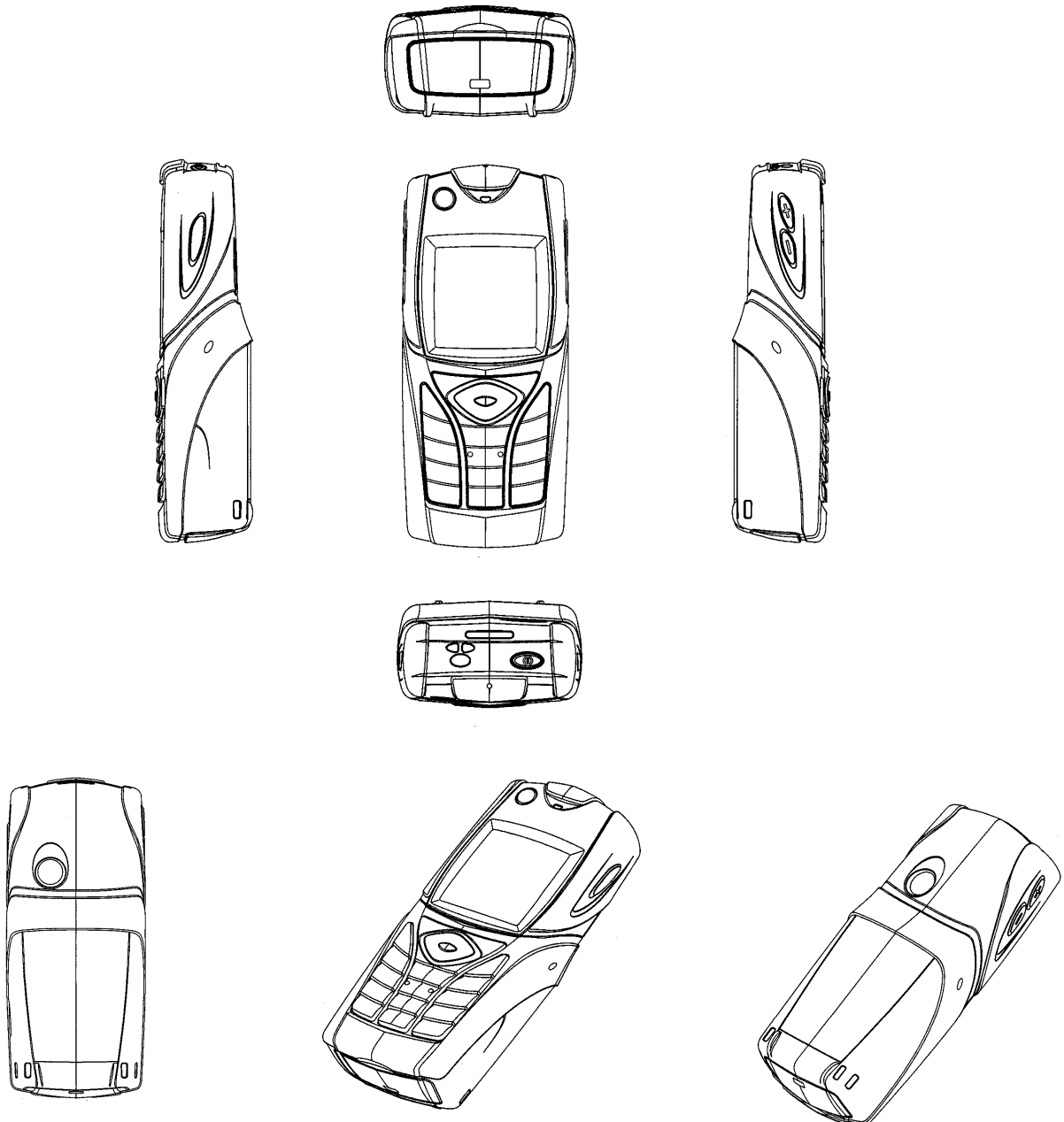

(11) Registreeringu number: **00968**

(51) Klass: **09-03**

(15) Registreerimise päev: 15.07.2004

(21) Taotluse number: D200400055

(22) Esitamise päev: 28.04.2004

(24) Registreeringu kehtivuse alguse päev: 28.04.2004

(18) Registreeringu kehtivuse lõppemise päev: 28.04.2009

(28) Variantide arv: 1

(72) Autor: Priit Petter, Veskimetsa 26, 10618 Tallinn, EE

(73) Omanik: OVEREST INVEST OÜ, Veskimetsa 26, 10618 Tallinn, EE

(54) Nimetus: **Piima- ja teraviljatoodete, mooside, džemmide, keediste, tarrendite jae- ja hulgimüügi portsjonide pakend**

(55) Reproduktsioon:

00968-01

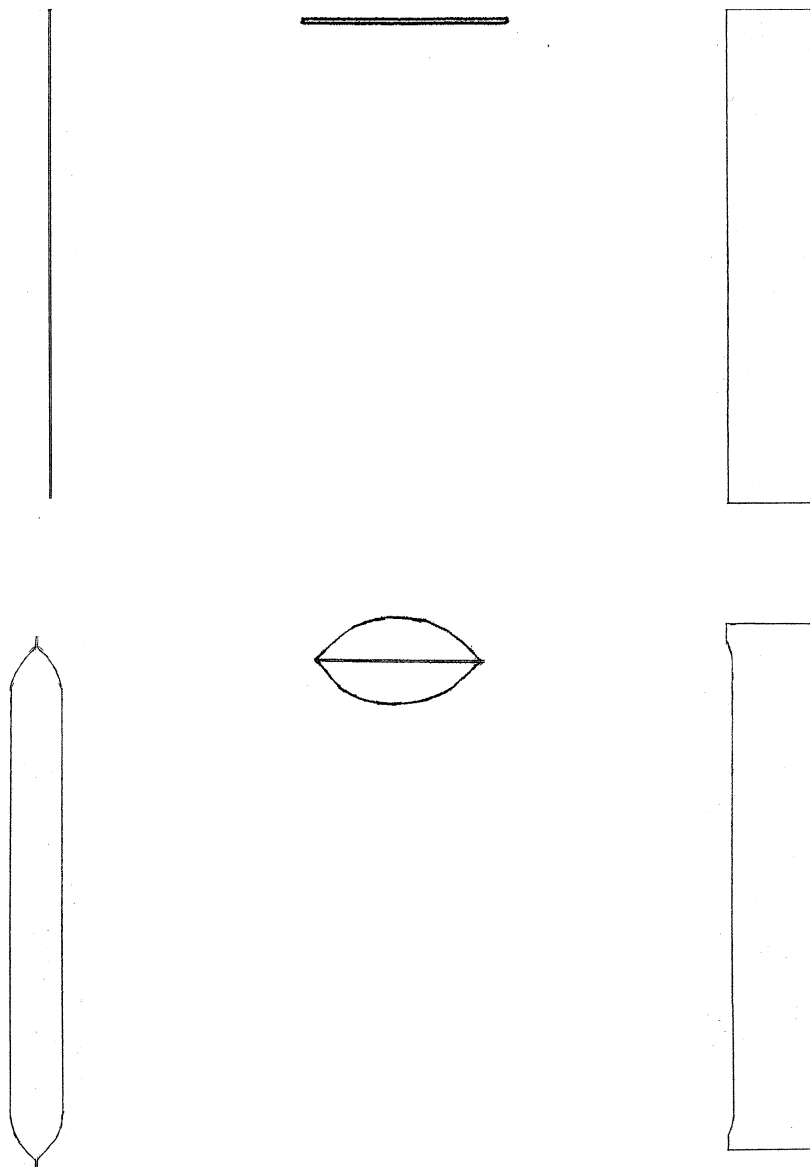

- (11) Registreeringu number: **00969**
- (15) Registreerimise päev: 15.07.2004
- (21) Taotluse number: D200400058
- (22) Esitamise päev: 07.05.2004
- (24) Registreeringu kehtivuse alguse päev: 07.05.2004
- (18) Registreeringu kehtivuse lõppemise päev: 07.05.2009
- (28) Variantide arv: 3
- (72) Autor: Räni Huul, Kääpa küla, Lasva vald, 65411 Võru maakond, EE
- (73) Omanik: Räni Huul, Kääpa küla, Lasva vald, 65411 Võru maakond, EE
- (74) Patendivolinik või ühine esindaja: Jüri Käosaar

(51) Klass: 25-03

(54) Nimetus: **Kapteni-grillmaja**

(55) Reproduktsoon:

00969-01

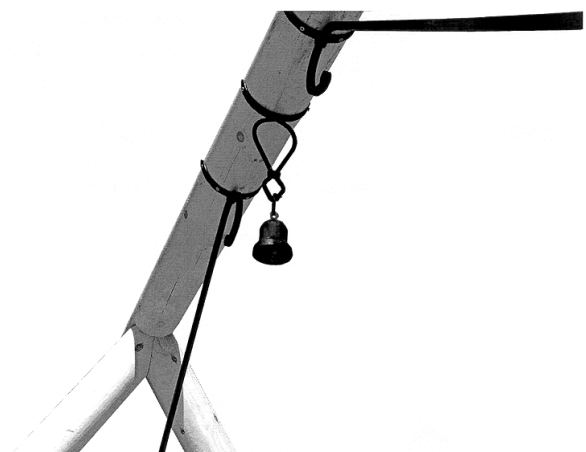
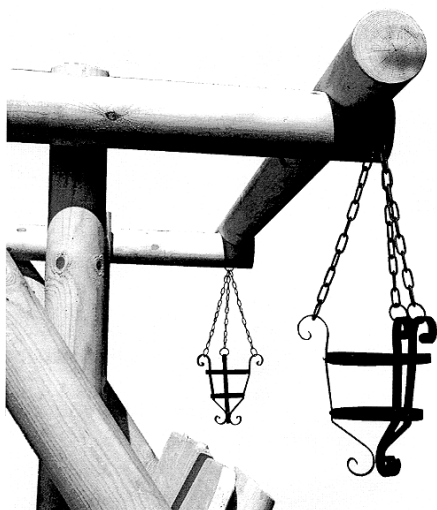
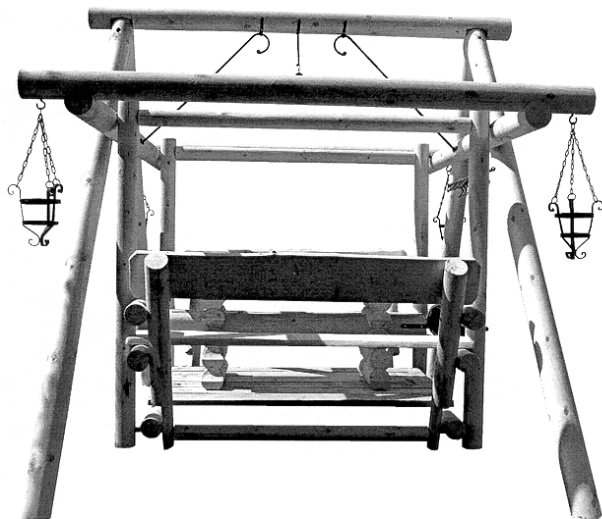
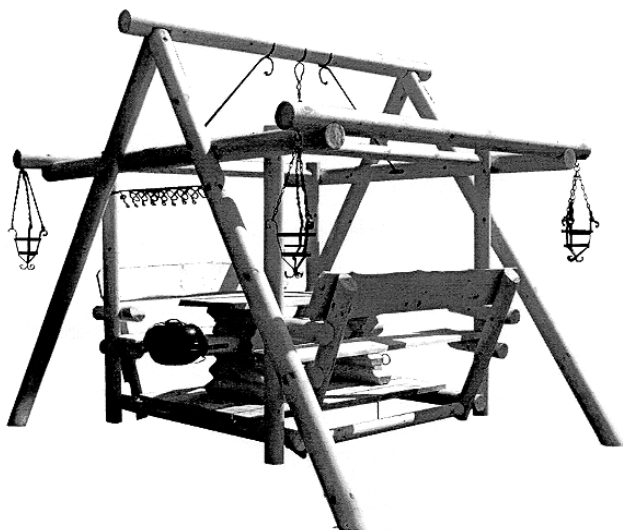

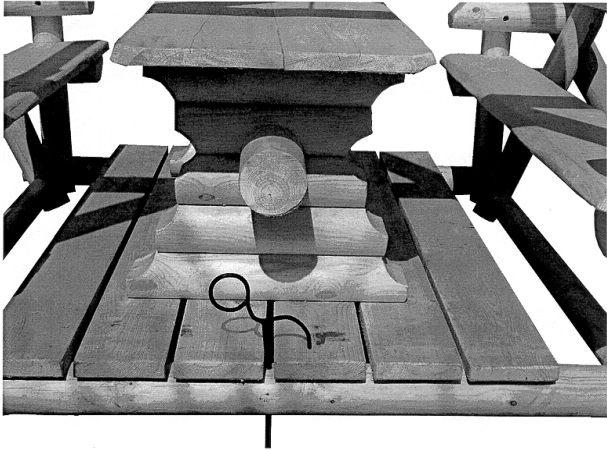
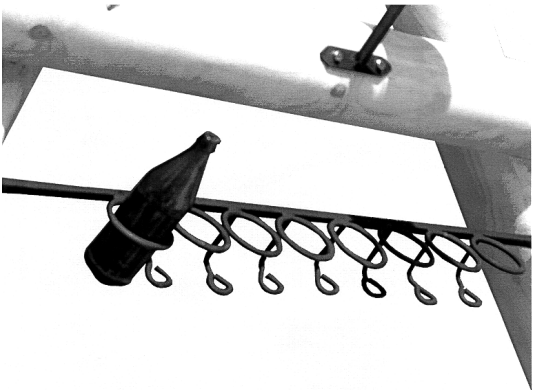

00969-02



00969-03





- (11) Registreeringu number: **00970** (51) Klass: **14-03, 12-06**
- (15) Registreerimise päev: 15.07.2004
- (21) Taotluse number: D200400069
- (22) Esitamise päev: 07.06.2004
- (24) Registreeringu kehtivuse alguse päev: 07.06.2004
- (18) Registreeringu kehtivuse lõppemise päev: 07.06.2009
- (28) Variantide arv: 2
- (72) Autor: Sergei Babitšenko, Kadaka tee 113 A, 12915 Tallinn, EE  
Veiko Paalma, Kadaka tee 113 A, 12915 Tallinn, EE  
Leino Vint, Kadaka tee 113 A, 12915 Tallinn, EE
- (73) Omanik: AS LASER DIAGNOSTIC INSTRUMENTS, Kadaka tee 113 A, 12915 Tallinn, EE
- (74) Patendivolinik või ühine esindaja: Ott Moorlat

(54) Nimetus: **Optiliste andmeside elementidega varustatud päästeparv**

(55) Reproduktioon:

00970-01

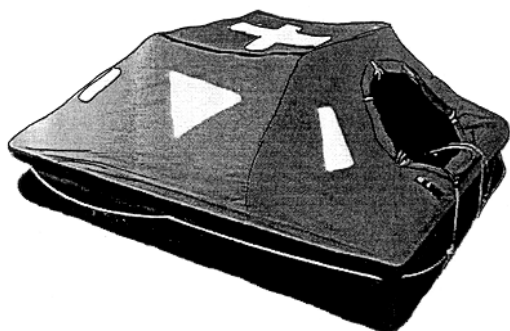

---

00970-02

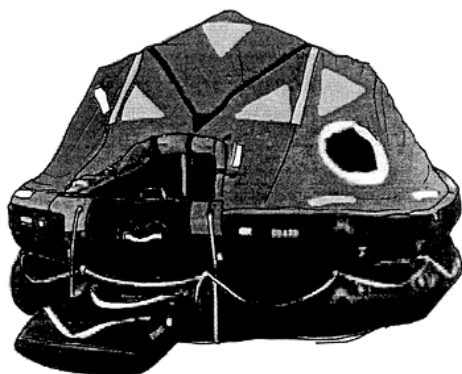

(11) Registreeringu number: **00971**

(51) Klass: **01-01**

(15) Registreerimise päev: 15.07.2004

(21) Taotluse number: D200400018

(22) Esitamise päev: 10.02.2004

(24) Registreeringu kehtivuse alguse päev: 10.02.2004

(18) Registreeringu kehtivuse lõppemise päev: 10.02.2009

(28) Variantide arv: 1

(72) Autor: Vida Konjikovic, c/o Kraft Foods France, 13, Avenue Morane Saulnier, 78140 Velizy-Villacoublay, FR

(73) Omanik: Kraft Foods Schweiz Holding AG, Bellerivestrasse 203, 8008 Zürich, CH

(74) Patendivolinik või ühine esindaja: Olga Treufeldt

(54) Nimetus: **Šokolaadiga kaetud biskviit**

(55) Reproduktsoon:

00971-01



- (11) Registreeringu number: **00972** (51) Klass: **14-03**
- (15) Registreerimise päev: 15.07.2004
- (21) Taotluse number: D200400059
- (22) Esitamise päev: 11.05.2004
- (24) Registreeringu kehtivuse alguse päev: 11.05.2004
- (18) Registreeringu kehtivuse lõppemise päev: 11.05.2009
- (28) Variantide arv: 1
- (30) Prioriteediandmed: M20030265, 11.11.2003, FI
- (72) Autor: Heikki Kangasmaa, Maurinkatu 14 D 42, 00170 Helsinki, FI
- (73) Omanik: Nokia Corporation, Keilalahdentie 4, FIN-02150 Espoo, FI
- (74) Patendivolinik või ühine esindaja: Kaie Puur

(54) Nimetus: **Käsitelefoni ülemine korpus / ülemine osa**

(55) Reproduktsoon:

00972-01

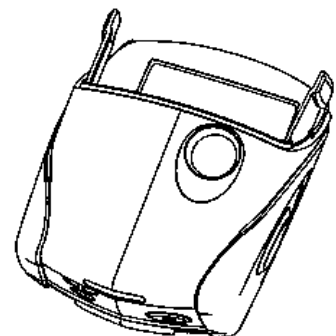
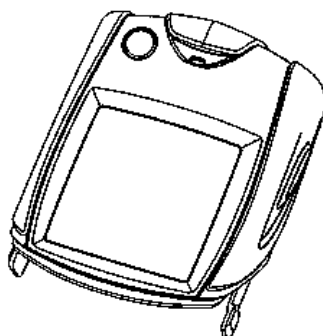
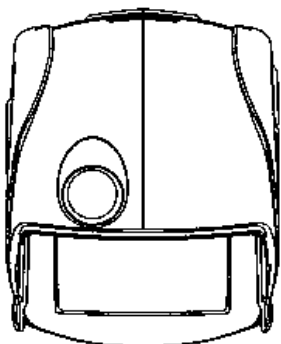
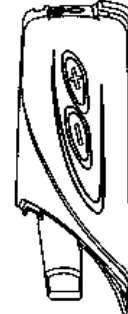
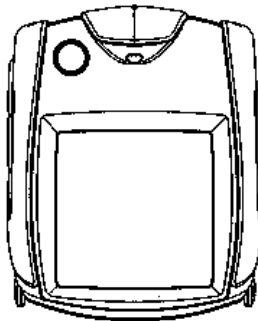
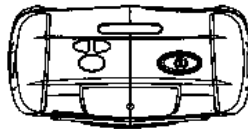

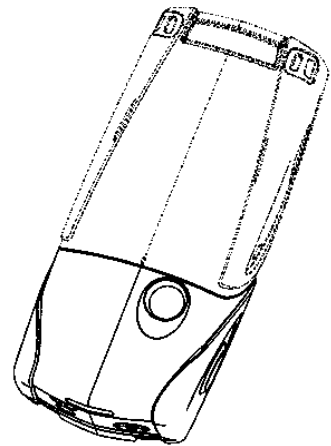
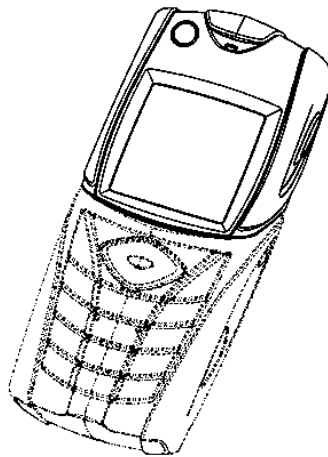
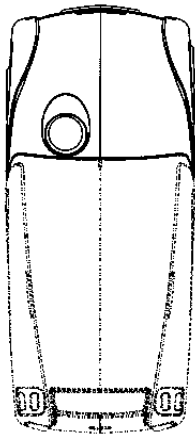
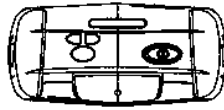
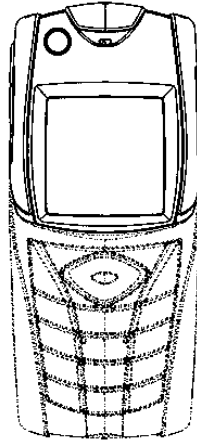

(11) Registreeringu number: **00973**

(51) Klass: **14-03**

(15) Registreerimise päev: 15.07.2004

(21) Taotluse number: D200400060

(22) Esitamise päev: 11.05.2004

(24) Registreeringu kehtivuse  
alguse päev: 11.05.2004

(18) Registreeringu kehtivuse  
lõppemise päev: 11.05.2009

(28) Variantide arv: 1

(30) Prioriteediandmed: M20030265, 11.11.2003, FI

(72) Autor: Heikki Kangasmaa, Maurinkatu 14 D 42, 00170 Helsinki, FI

(73) Omanik: Nokia Corporation, Keilalahdentie 4, FIN-02150 Espoo, FI

(74) Patendivolinik või ühine esindaja: Kaie Puur

(54) Nimetus: **Käsitelefoni klaviatuur / klaviatuuriklahvide paigutus**

(55) Reproduktsoon:

00973-01

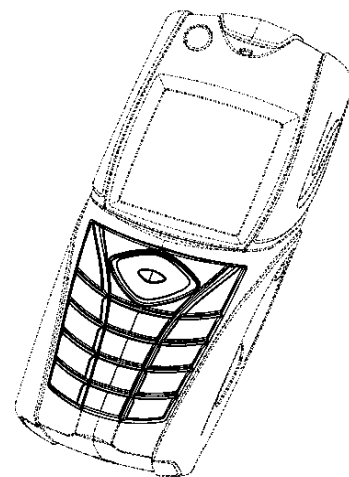
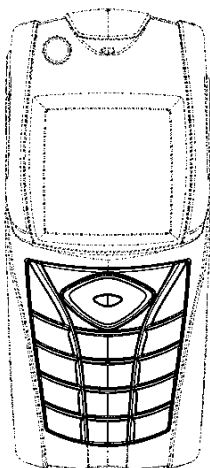
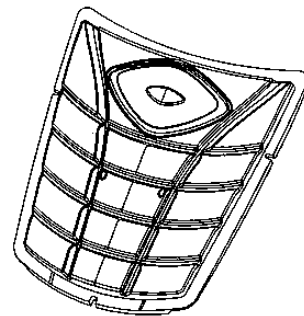
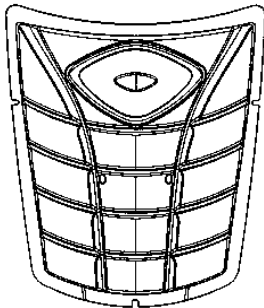

(11) Registreeringu number: **00974**

(51) Klass: **14-03**

(15) Registreerimise päev: 15.07.2004

(21) Taotluse number: D200400062

(22) Esitamise päev: 11.05.2004

(24) Registreeringu kehtivuse alguse päev: 11.05.2004

(18) Registreeringu kehtivuse lõppemise päev: 11.05.2009

(28) Variantide arv: 1

(30) Prioriteediandmed: M20030265, 11.11.2003, FI

(72) Autor: Heikki Kangasmaa, Maurinkatu 14 D 42, 00170 Helsinki, FI

Kati Björninen, Lönnrotinkatu 45 A 35, 00180 Helsinki, FI

(73) Omanik: Nokia Corporation, Keilalahdentie 4, FIN-02150 Espoo, FI

(74) Patendivolinik või ühine esindaja: Kaie Puur

(54) Nimetus: **Käsitelefoni klaviatuur / käsitelefoni klaviatuuriklahvide paigutus**

(55) Reproduktioon:

00974-01

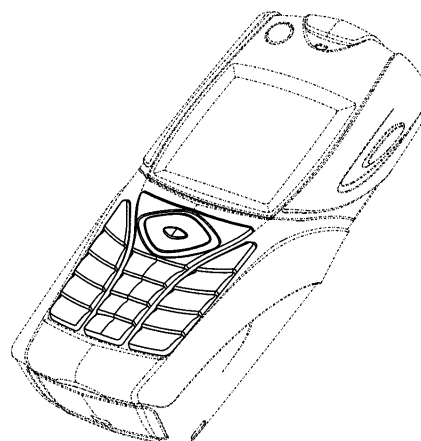
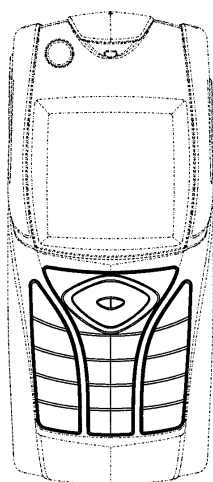
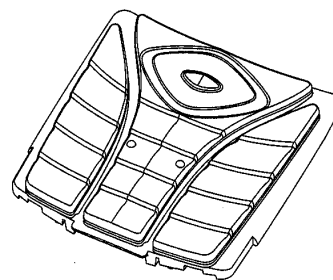
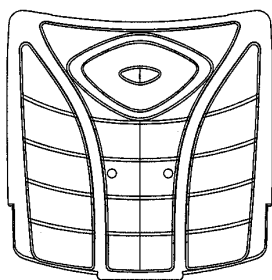

(11) Registreeringu number: **00975**

(51) Klass: **14-03**

(15) Registreerimise päev: 15.07.2004

(21) Taotluse number: D200400064

(22) Esitamise päev: 11.05.2004

(24) Registreeringu kehtivuse alguse päev: 11.05.2004

(18) Registreeringu kehtivuse lõppemise päev: 11.05.2009

(28) Variantide arv: 1

(30) Prioriteediandmed: M20030265, 11.11.2003, FI

(72) Autor: Heikki Kangasmaa, Maurinkatu 14 D 42, 00170 Helsinki, FI

(73) Omanik: Nokia Corporation, Keilalahdentie 4, FIN-02150 Espoo, FI

(74) Patendivolinik või ühine esindaja: Kaie Puur

(54) Nimetus: **Käsitelefoni alumine korpus / alumine osa**

(55) Reproduksioon:

00975-01

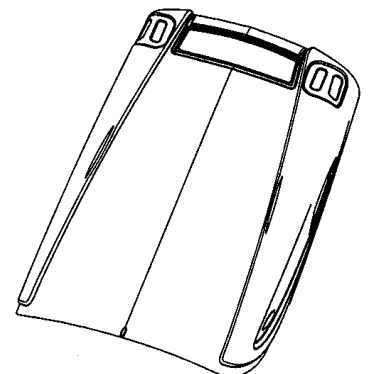
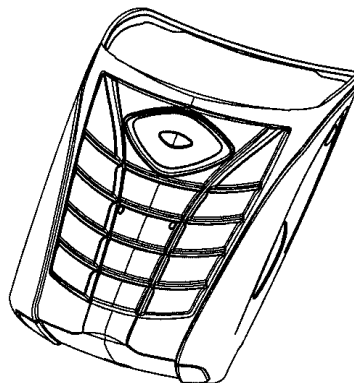
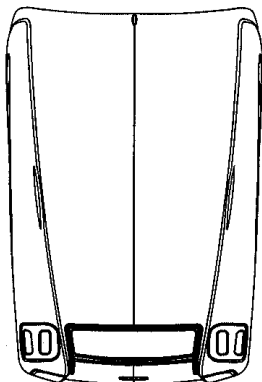
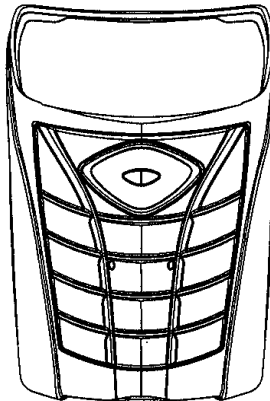
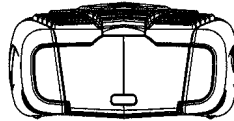

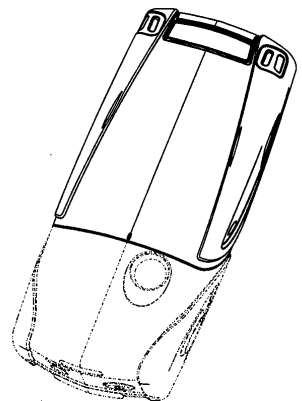
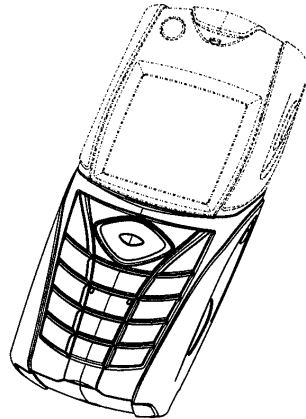
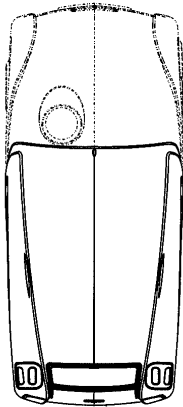
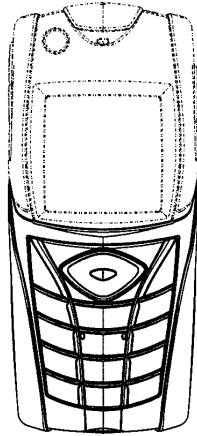
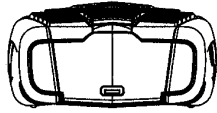



- (11) Registreeringu number: **00976** (51) Klass: **14-03**
- (15) Registreerimise päev: 15.07.2004
- (21) Taotluse number: D200400065
- (22) Esitamise päev: 11.05.2004
- (24) Registreeringu kehtivuse alguse päev: 11.05.2004
- (18) Registreeringu kehtivuse lõppemise päev: 11.05.2009
- (28) Variantide arv: 1
- (30) Prioriteediandmed: M20030265, 11.11.2003, FI
- (72) Autor: Heikki Kangasmaa, Maurinkatu 14 D 42, 00170 Helsinki, FI  
Kati Björninen, Lönnrotinkatu 45 A 35, 00180 Helsinki, FI
- (73) Omanik: Nokia Corporation, Keilalahdentie 4, FIN-02150 Espoo, FI
- (74) Patendivolinik või ühine esindaja: Kaie Puur

(54) Nimetus: **Käsitelefoni alumine korpus / alumine osa**

(55) Reproduktsoon:

00976-01

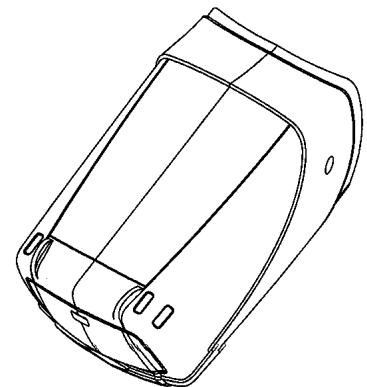
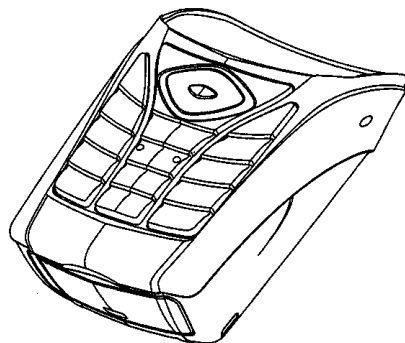
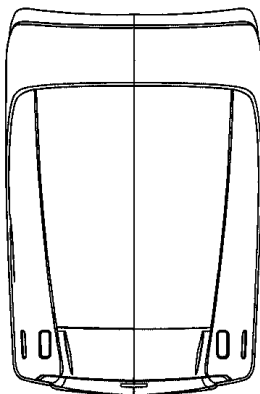
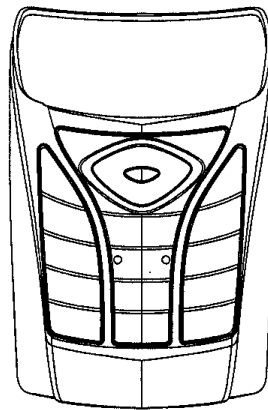
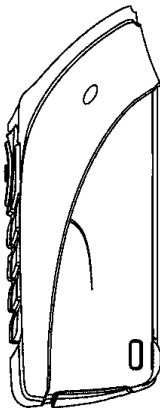
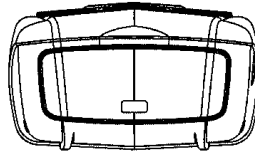

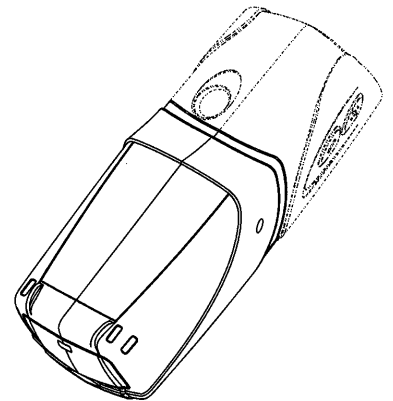
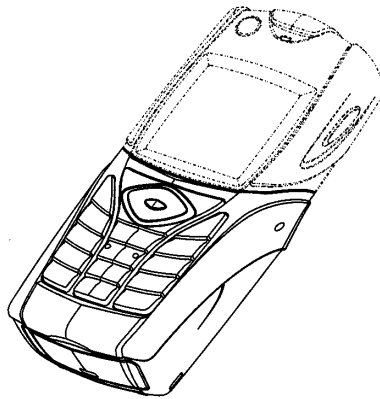
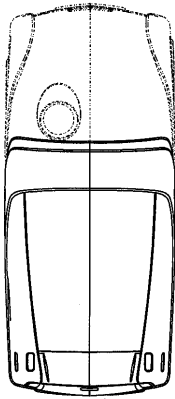
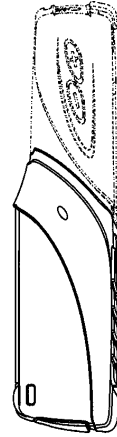
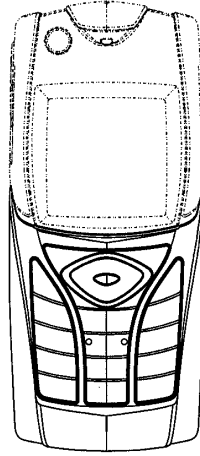
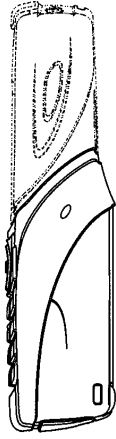
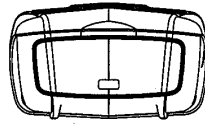

**II. TÖÖSTUSDISAINILAHENDUSE REGISTREERINGU  
KEHTIVUSE PIKENDAMINE**

(11)	(18)
00374	31.05.2009
00376	04.06.2009
00378	13.07.2009
00379	23.07.2009
00383	26.08.2009
00387	16.06.2009
00388	16.06.2009
00389	16.06.2009
00390	16.06.2009
00391	16.06.2009
00392	16.06.2009
00393	16.06.2009
00394	16.06.2009
00395	16.06.2009
00396	23.07.2009
00398	04.06.2009
00421	10.06.2009

**V. TÖÖSTUSDISAINILAHENDUSE REGISTREERINGU  
KUSTUTAMINE**

(11)	
00324	00340
00327	00344
00328	00345
00332	00351
00333	00352
00334	00353
00335	00358
00336	00359
00337	00381
00339	

## VII. LOENDID

## REGISTREERITUD TÖÖSTUSDISAINILAHENDUSTE SÜSTEMAATILINE LOEND

Rahvusvahelise klassifikatsiooni klass ja alaklass(id)	Registreerimis-taotluse number	Registreeringu number			
01-01	D200400018	00971	14-03	D200400045	00956
07-02	D200400004	00936	14-03	D200400046	00957
07-99	D200400004	00936	14-03	D200400047	00958
09-01	D200400035	00946	14-03	D200400052	00965
09-03	D200400048	00959	14-03	D200400053	00963
09-03	D200400049	00960	14-03	D200400059	00972
09-03	D200400050	00961	14-03	D200400060	00973
09-03	D200400051	00962	14-03	D200400061	00966
09-03	D200400055	00968	14-03	D200400062	00974
09-07	D200300148	00934	14-03	D200400063	00967
12-06	D200400069	00970	14-03	D200400064	00975
12-08	D200400001	00935	14-03	D200400065	00976
13-02	D200400034	00945	14-03	D200400069	00970
13-02	D200400054	00964	20-03	D200400036	00947
14-01	D200400053	00963	23-02	D200400037	00948
14-02	D200400053	00963	23-02	D200400039	00950
14-03	D200400021	00937	23-02	D200400040	00951
14-03	D200400022	00938	24-01	D200400038	00949
14-03	D200400023	00939	24-01	D200400039	00950
14-03	D200400024	00940	24-01	D200400040	00951
14-03	D200400027	00941	24-01	D200400041	00952
14-03	D200400028	00942	24-01	D200400042	00953
14-03	D200400029	00943	24-01	D200400043	00954
14-03	D200400030	00944	25-03	D200400058	00969
14-03	D200400044	00955			

## REGISTREERITUD TÖÖSTUSDISAINILAHENDUSTE REGISTREERIMISTAOTLUSTE NUMBRILINE LOEND

Registreerimis-taotluse number	Registreeringu number	Rahvusvahelise klassifikatsiooni klass(id) ja alaklass(id)			
D200300148	00934	09-07	D200400044	00955	14-03
D200400001	00935	12-08	D200400045	00956	14-03
D200400004	00936	07-02	D200400046	00957	14-03
D200400004	00936	07-99	D200400047	00958	14-03
D200400018	00971	01-01	D200400048	00959	09-03
D200400021	00937	14-03	D200400049	00960	09-03
D200400022	00938	14-03	D200400050	00961	09-03
D200400023	00939	14-03	D200400051	00962	09-03
D200400024	00940	14-03	D200400052	00965	14-03
D200400027	00941	14-03	D200400053	00963	14-01
D200400028	00942	14-03	D200400053	00963	14-02
D200400029	00943	14-03	D200400053	00963	14-03
D200400030	00944	14-03	D200400054	00964	13-02
D200400034	00945	13-02	D200400055	00968	09-03
D200400035	00946	09-01	D200400058	00969	25-03
D200400036	00947	20-03	D200400059	00972	14-03
D200400037	00948	23-02	D200400060	00973	14-03
D200400038	00949	24-01	D200400061	00966	14-03
D200400039	00950	23-02	D200400062	00974	14-03
D200400039	00950	24-01	D200400063	00967	14-03
D200400040	00951	23-02	D200400064	00975	14-03
D200400040	00951	24-01	D200400065	00976	14-03
D200400041	00952	24-01	D200400065	00976	14-03
D200400042	00953	24-01	D200400069	00970	12-06
D200400043	00954	24-01	D200400069	00970	14-03

## VIII. TÖÖSTUSDISAINIALASED ÕIGUSAKTID JA MUU INFO

### RIIKLIKUS PATENDIVOLINIKE REGISTRIS REGISTREERITUD PATENDIVOLINIKE NIMEKIRI (seisuga 20. juuli 2004)

Register on asutatud 1. septembril 2001. a Vabariigi Valitsuse 7. augusti 2001. a määrusega nr 271 "Riikliku patendivolinike registri asutamine ja registri pidamise põhimäärus" (RT I 2001, 70, 426) patendivoliniku seaduse § 21 alusel (RT I 2001, 27, 151).

#### TEGEVUSVALDKOND: KAUBAMÄRK, TÖÖSTUSDISAINILAHENDUS JA GEOGRAAFILINE TÄHIS

<b>Arno ANIJALG</b>	<b>OÜ USTERVALL</b> Raekoja plats 16 51004 Tartu pk 21, 50002 Tartu telefon: 744 1980 telefaks: 744 1785 e-post: anijalg@ustervall.ee <a href="http://www.ustervall.ee">http://www.ustervall.ee</a> võõrkeeled: saksa, vene	<b>Juhan HÄMMALOV</b>	<b>OÜ Intels</b> Riia 11-3 51010 Tartu telefon: 742 0401 telefaks: 742 0326 e-post: intelses@estpak.ee võõrkeeled: inglise, saksa, vene
<b>Aivo ARULA</b>	<b>Patendibüroo Käosaar &amp; Co OÜ</b> Tähe 94 50107 Tartu telefon: 738 3051 telefaks: 738 3055 e-post: info@kaosaar.ee <a href="http://www.kaosaar.ee">http://www.kaosaar.ee</a> võõrkeeled: inglise, vene	<b>Uno JÄÄGER</b>	<b>Patendibüroo Käosaar &amp; Co OÜ</b> Rüütli 51A, 80010 Pärnu telefon: 447 1021 telefaks: 447 1001 GSM: 551 1758 e-post: uno@estpak.ee <a href="http://www.kaosaar.ee">http://www.kaosaar.ee</a> võõrkeeled: inglise, soome, vene
<b>Martina BÖCKLER</b>	<b>OÜ LASVET</b> Suurtüki 4a, 10133 Tallinn pk 3136, 10505 Tallinn telefon: 640 6600 telefaks: 640 6604 e-post: lasvet@lasvet.ee <a href="http://www.lasvet.ee">http://www.lasvet.ee</a> võõrkeeled: inglise, vene, soome	<b>Sirje KAHU</b>	<b>OÜ USTERVALL</b> Raekoja plats 16 51004 Tartu pk 21, 50002 Tartu telefon: 744 1980 telefaks: 744 1785 e-post: skahu@ustervall.ee <a href="http://www.ustervall.ee">http://www.ustervall.ee</a> võõrkeeled: inglise, vene
<b>Indrek EELMETS</b>	<b>OÜ LASVET</b> Suurtüki 4a, 10133 Tallinn pk 3136, 10505 Tallinn telefon: 640 6600 telefaks: 640 6604 e-post: lasvet@lasvet.ee <a href="http://www.lasvet.ee">http://www.lasvet.ee</a> võõrkeeled: inglise, vene, soome	<b>Lembit KALEV</b>	<b>Patendibüroo ROOSILLA OÜ</b> Järveotsa tee 39-61 13520 Tallinn telefon: 657 1722, 657 5381 telefaks: 657 5381 GSM: 511 9951 e-post: roosilla@roosilla.ee <a href="http://www.roosilla.ee">http://www.roosilla.ee</a> võõrkeeled: inglise, vene
<b>Alla HÄMMALOV</b>	<b>OÜ Intels</b> Riia 11-3 51010 Tartu telefon: 742 0401 telefaks: 742 0326 e-post: intelses@estpak.ee võõrkeeled: inglise, poola, vene	<b>Urmas KAULER</b>	<b>Patendibüroo TURVAJA OÜ</b> Liivalaia 22 10118 Tallinn telefon: 640 3109 telefaks: 640 3105 e-post: kauler@turvaja.ee <a href="http://www.turvaja.ee">http://www.turvaja.ee</a> võõrkeeled: inglise, vene, soome

- Urmas KERNU**      **AAA Patendibüroo OÜ**  
Tartu mnt 16  
10117 Tallinn  
pk 3926, 10509 Tallinn  
telefon: 660 5910, 660 5911  
telefaks: 660 5912  
e-post: aaa@aaa.ee  
http://www.aaa.ee  
võõrkeeled: inglise, saksa,  
soome, vene
- Ljubov KESSELMAN**      **OÜ Kesna**  
Tedre 77-52  
10616 Tallinn  
telefon: 660 8068  
telefaks: 660 8069  
e-post: kesna@online.ee  
võõrkeeled: inglise, vene
- Marina KESSELMAN**      **OÜ Kesna**  
Tedre 77-52  
10616 Tallinn  
telefon: 660 8068  
telefaks: 660 8069  
e-post: kesna@online.ee  
võõrkeeled: inglise, saksa, vene
- Heinu KOITEL**      **Patendi- & Kaubamärgibüroo  
Koitel OÜ**  
Tartu mnt 65  
10115 Tallinn  
pk 1759, 10902 Tallinn  
telefon: 603 3260  
telefaks: 603 3261  
e-post: koitel@koitel.ee  
http://www.koitel.ee  
võõrkeeled: inglise, soome, vene
- Raivo KOITEL**      **Patendi- & Kaubamärgibüroo  
Koitel OÜ**  
Tartu mnt 65  
10115 Tallinn  
pk 1759, 10902 Tallinn  
telefon: 603 3260  
telefaks: 603 3261  
e-post: koitel@koitel.ee  
http://www.koitel.ee  
võõrkeeled: inglise, soome, vene
- Mart Enn KOPPEL**      **Patendibüroo Koppel OÜ**  
Kajaka 4-10  
11317 Tallinn  
telefon: 677 4136  
telefaks: 677 4138  
e-post: info@koppelpb.com  
http://www.koppelpb.com  
võõrkeeled: inglise, vene, soome
- Heinrich KRUPP**      **Patendibüroo TURVAJA OÜ**  
Liivalaia 22  
10118 Tallinn  
telefon: 640 3109  
telefaks: 640 3105  
e-post: turvaja@turvaja.ee  
http://www.turvaja.ee  
võõrkeeled: saksa, vene
- Jüri KÄOSAAR**      **Patendibüroo Käosaar & Co  
OÜ**  
Tähe 94  
50107 Tartu  
telefon: 738 3051  
telefaks: 738 3055  
e-post: info@kaosaar.ee  
http://www.kaosaar.ee  
võõrkeeled: inglise, vene
- Kalev KÄOSAAR**      **Patendibüroo Käosaar & Co  
OÜ**  
Peterburi tee 46  
11415 Tallinn  
telefon: 637 9484  
telefaks: 637 9485  
e-post: kalev.kaosaar@kaosaar.ee  
http://www.kaosaar.ee  
võõrkeeled: inglise, vene
- Reet MAASIKAMÄE**      **OÜ Kaitsepurus**  
Mulla 4-3  
10611 Tallinn  
telefon: 673 9097, 633 2798  
telefaks: 677 4844  
e-post: purus@online.ee  
purus@hot.ee  
http://www.hot.ee/purus/  
võõrkeeled: inglise, vene
- Raivo MATSOO**      **RM Hirvela Patendibüroo OÜ**  
Saku 15, 11314 Tallinn  
telefon: 614 0816  
telefaks: 614 0818  
e-post: hirvela@online.ee  
võõrkeeled: inglise, vene
- Elle MELLIK**      **AAA Patendibüroo OÜ**  
Tartu mnt 16  
10117 Tallinn  
pk 3926, 10509 Tallinn  
telefon: 660 5910, 660 5911  
telefaks: 660 5912  
e-post: aaa@aaa.ee  
http://www.aaa.ee  
võõrkeeled: inglise, vene

<b>Lembit MITT</b>	<b>AAA Patendibüroo OÜ</b> Tartu mnt 16 10117 Tallinn pk 3926, 10509 Tallinn telefon: 660 5910, 660 5911 telefaks: 660 5912 e-post: aaa@aaa.ee http://www.aaa.ee võõrkeeled: inglise, vene	<b>Villu PAVELTS</b>	<b>OÜ LASVET</b> Suurtüki 4a, 10133 Tallinn pk 3136, 10505 Tallinn telefon: 640 6600 telefaks: 640 6604 e-post: lasvet@lasvet.ee http://www.lasvet.ee võõrkeeled: inglise, soome, vene
<b>Ott MOORLAT</b>	<b>OÜ Moorlat &amp; Ko Patendibüroo</b> pk 723, 12902 Tallinn telefon: 655 0450, 654 2844 telefaks: 654 2844 e-post: ott.moorlat@moorlat.ee http://www.moorlat.ee võõrkeeled: inglise, vene	<b>Anneli PUNGAS</b>	<b>OÜ Synest</b> pk 977, 13402 Tallinn telefon: 660 9786 telefaks: 660 9787 e-post: anneli@synest.ee võõrkeeled: inglise, saksa, vene, prantsuse, soome, rootsi
<b>Anfia MORNA</b>	<b>Patendibüroo TURVAJA OÜ</b> Liivalaia 22, 10118 Tallinn telefon: 640 3109 telefaks: 640 3105 e-post: morna@turvaja.ee http://www.turvaja.ee võõrkeeled: inglise, vene	<b>Toom PUNGAS</b>	<b>OÜ Synest</b> pk 977, 13402 Tallinn telefon: 660 9786 telefaks: 660 9787 e-post: toom@synest.ee võõrkeeled: inglise, saksa, soome, vene
<b>Tõnu NELSAS</b>	<b>AAA Patendibüroo OÜ</b> Tartu mnt 16 10117 Tallinn pk 3926, 10509 Tallinn telefon: 660 5910, 660 5911 telefaks: 660 5912 e-post: aaa@aaa.ee http://www.aaa.ee võõrkeeled: inglise, vene, soome	<b>Kaie PUUR</b>	<b>Patendibüroo Käosaar &amp; Co OÜ</b> Tähe 94 50107 Tartu telefon: 738 3051 telefaks: 738 3055 e-post: info@kaosaar.ee http://www.kaosaar.ee võõrkeeled: inglise, vene
<b>Jüri OLT</b>	<b>Patendibüroo Käosaar &amp; Co OÜ</b> Tähe 94, 50107 Tartu telefon: 738 3051 telefaks: 738 3055 e-post: info@kaosaar.ee http://www.kaosaar.ee võõrkeeled: inglise, saksa, soome, vene	<b>Riina PÄRN</b>	<b>OÜ Intels</b> Riia 11-3 51010 Tartu telefon: 742 0401 telefaks: 742 0326 e-post: intelses@estpak.ee võõrkeeled: inglise, vene
<b>Jaak OSTRAT</b>	<b>OÜ LASVET</b> Suurtüki 4a, 10133 Tallinn pk 3136, 10505 Tallinn telefon: 640 6600 telefaks: 640 6604 e-post: lasvet@lasvet.ee http://www.lasvet.ee võõrkeeled: inglise, saksa, soome, vene	<b>Tarmo ROSMAN</b>	<b>Rosman ja Partnerid OÜ</b> pk 652, 12602 Tallinn telefon: 656 1450 telefaks: 656 1450 e-post: tarman@cc.ttu.ee võõrkeeled: saksa, inglise, ungari, vene
		<b>Arvo SALUMÄE</b>	<b>OÜ Amende Patendibüroo</b> Raua 65 10152 Tallinn telefon: 648 6125 telefaks: 641 0174 e-post: amende@hot.ee võõrkeeled: inglise, saksa, soome, vene

**Almar SEHVER****AAA Patendibüroo OÜ**

Tartu mnt 16  
10117 Tallinn  
pk 3926, 10509 Tallinn  
telefon: 660 5910, 660 5911  
telefaks: 660 5912  
e-post: aaa@aaa.ee  
<http://www.aaa.ee>  
võõrkeeled: inglise, vene

**Enn URGAS****Patendibüroo TURVAJA OÜ**

Liivalaia 22  
10118 Tallinn  
telefon: 640 3109  
telefaks: 640 3105  
e-post: [urgas@turvaja.ee](mailto:urgas@turvaja.ee)  
<http://www.turvaja.ee>  
võõrkeeled: inglise, vene

**Harald TEHVER****Patendibüroo TURVAJA OÜ**

Liivalaia 22  
10118 Tallinn  
telefon: 640 3109  
telefaks: 640 3105  
e-post: [tehver@turvaja.ee](mailto:tehver@turvaja.ee)  
<http://www.turvaja.ee>  
võõrkeeled: inglise, saksa, vene

**Juta-Maris UUSTALU OÜ LASVET**

Suurtüki 4a, 10133 Tallinn  
pk 3136, 10505 Tallinn  
telefon: 640 6600  
telefaks: 640 6604  
e-post: [lasvet@lasvet.ee](mailto:lasvet@lasvet.ee)  
<http://www.lasvet.ee>  
võõrkeeled: inglise, vene

**Olga TREUFELDT****Patendibüroo TURVAJA OÜ**

Liivalaia 22  
10118 Tallinn  
telefon: 640 3109  
telefaks: 640 3105  
e-post: [olga@turvaja.ee](mailto:olga@turvaja.ee)  
<http://www.turvaja.ee>  
võõrkeeled: inglise, vene



**LIST OF PATENT ATTORNEYS, REGISTERED IN  
THE ESTONIAN STATE REGISTER OF PATENT ATTORNEYS**  
(by 20 July 2004)

Register is established on September 1<sup>st</sup> 2001

**FIELD OF ACTIVITY: TRADEMARKS, INDUSTRIAL DESIGNS AND GEOGRAPHICAL INDICATIONS**

<b>Arno ANIJALG</b>	<b>USTERVALL Ltd.</b> Raekoja plats 16 51004 Tartu, Estonia P.O. Box 21 50002 Tartu, Estonia Phone: +372 744 1980 Fax: +372 744 1785 E-mail: anijalg@ustervall.ee Http://www.ustervall.ee German, Russian, Estonian	<b>Juhan HÄMMALOV</b>	<b>Intels Ltd.</b> Riia Str. 11-3 51010 Tartu, Estonia Phone: +372 742 0401 Fax: +372 742 0326 E-mail: intelses@estpak.ee English, German, Russian, Estonian
<b>Aivo ARULA</b>	<b>Patent Agency Käosaar &amp; Co</b> Tähe Str. 94 50107 Tartu, Estonia Phone: +372 738 3051 Fax: +372 738 3055 E-mail: info@kaosaar.ee Http://www.kaosaar.ee English, Russian, Estonian	<b>Uno JÄÄGER</b>	<b>Patent Agency Käosaar &amp; Co</b> Rüütli 51A 80010 Pärnu, Estonia Phone: +372 447 1021 Fax: +372 447 1001 GSM: +372 551 1758 E-mail: uno@estpak.ee Http://www.kaosaar.ee English, Finnish, Russian, Estonian
<b>Martina BÖCKLER</b>	<b>Lasvet Ltd.</b> P.O. Box 3136 10505 Tallinn, Estonia Phone: +372 640 6600 Fax: +372 640 6604 E-mail: lasvet@lasvet.ee Http://www.lasvet.ee English, Russian, Finnish, Estonian	<b>Sirje KAHU</b>	<b>USTERVALL Ltd.</b> Raekoja plats 16 51004 Tartu, Estonia P.O. Box 21 50002 Tartu, Estonia Phone: +372 744 1980 Fax: +372 744 1785 E-mail: skahu@ustervall.ee Http://www.ustervall.ee English, Russian, Estonian
<b>Indrek EELMETS</b>	<b>Lasvet Ltd.</b> P.O. Box 3136 10505 Tallinn, Estonia Phone: +372 640 6600 Fax: +372 640 6604 E-mail: lasvet@lasvet.ee Http://www.lasvet.ee English, Finnish, Russian, Estonian	<b>Lembit KALEV</b>	<b>Patent Bureau ROOSILLA Ltd.</b> Järveotsa Road 39-61 13520 Tallinn, Estonia Phone: +372 657 1722 +372 657 5381 Fax: +372 657 5381 GSM: +372 511 9951 E-mail: roosilla@roosilla.ee Http://www.roosilla.ee English, Russian, Estonian
<b>Alla HÄMMALOV</b>	<b>Intels Ltd.</b> Riia Str. 11-3 51010 Tartu, Estonia Phone: +372 742 0401 Fax: +372 742 0326 E-mail: intelses@estpak.ee English, Polish, Russian, Estonian		

- Urmast KAULER**      **Patendibüroo TURVAJA OÜ**  
 Liivalaia 22  
 10118 Tallinn, Estonia  
 Phone: +372 640 3109  
 Fax: +372 640 3105  
 E-mail: kauler@turvaja.ee  
 Http://www.turvaja.ee  
 English, Russian, Finnish,  
 Estonian
- Urmast KERNU**      **AAA Legal Services**  
 Tartu Road 16  
 10117 Tallinn, Estonia  
 P.O. Box 3926  
 10509 Tallinn, Estonia  
 Phone: +372 660 5910  
 +372 660 5911  
 Fax: +372 660 5912  
 E-mail: aaa@aaa.ee  
 Http://www.aaa.ee  
 English, German, Finnish,  
 Russian, Estonian
- Marina KESSELMAN**      **Kesna Ltd.**  
 Tedre Str. 77-52  
 10616 Tallinn, Estonia  
 Phone: +372 660 8068  
 Fax: +372 660 8069  
 E-mail: kesna@online.ee  
 English, German, Russian,  
 Estonian
- Ljubov KESSELMAN**      **Kesna Ltd.**  
 Tedre Str. 77-52  
 10616 Tallinn, Estonia  
 Phone: +372 660 8068  
 Fax: +372 660 8069  
 E-mail: kesna@online.ee  
 English, Russian, Estonian
- Heinu KOITEL**      **Patent- & Trademark Office  
 Koitel Ltd.**  
 Tartu Road 65  
 10115 Tallinn, Estonia  
 P.O. Box 1759  
 10902 Tallinn, Estonia  
 Phone: +372 603 3260  
 Fax: +372 603 3261  
 E-mail: koitel@koitel.ee  
 Http://www.koitel.ee  
 English, Finnish, Russian,  
 Estonian
- Raivo KOITEL**      **Patent- & Trademark Office  
 Koitel Ltd.**  
 Tartu Road 65  
 10115 Tallinn, Estonia  
 P.O. Box 1759  
 10902 Tallinn, Estonia  
 Phone: +372 603 3260  
 Fax: +372 603 3261  
 E-mail: koitel@koitel.ee  
 Http://www.koitel.ee  
 English, Finnish, Russian,  
 Estonian
- Mart Enn KOPPEL**      **Patent Bureau Koppel**  
 Kajaka 4-10  
 11317 Tallinn, Estonia  
 Phone: +372 677 4136  
 Fax: +372 677 4138  
 E-mail: info@koppelpb.com  
 Http://www.koppelpb.com  
 English, Russian, Finnish,  
 Estonian
- Heinrich KRUPP**      **Patendibüroo TURVAJA OÜ**  
 Liivalaia 22  
 10118 Tallinn, Estonia  
 Phone: +372 640 3109  
 Fax: +372 640 3105  
 E-mail: turvaja@turvaja.ee  
 Http://www.turvaja.ee  
 German, Russian, Estonian
- Jüri KÄOSAAR**      **Patent Agency Käosaar & Co**  
 Tähe Str. 94  
 50107 Tartu, Estonia  
 Phone: +372 738 3051  
 Fax: +372 738 3055  
 E-mail: info@kaosaar.ee  
 Http://www.kaosaar.ee  
 English, Russian, Estonian
- Kalev KÄOSAAR**      **Patent Agency Käosaar & Co**  
 Peterburi Road 46  
 11415 Tallinn, Estonia  
 Phone: +372 637 9484  
 Fax: +372 637 9485  
 E-mail:  
 kalev.kaosaar@kaosaar.ee  
 Http://www.kaosaar.ee  
 English, Russian, Estonian

<b>Reet MAASIKAMÄE</b>	<b>Patent Bureau Kaitsepurus Ltd.</b> Mulla Str. 4-3 10611 Tallinn, Estonia Phone: +372 673 9097 +372 633 2798 Fax: +372 677 4844 E-mail: purus@online.ee purus@hot.ee Http://www.hot.ee/purus/ English, Russian, Estonian	<b>Anfia MORNA</b>	<b>Patendibüroo TURVAJA OÜ</b> Liivalaia 22 10118 Tallinn, Estonia Phone: +372 640 3109 Fax: +372 640 3105 E-mail: morna@turvaja.ee Http://www.turvaja.ee English, Russian, Estonian
<b>Raivo MATSOO</b>	<b>RM Hirvela Patent Bureau Ltd</b> Saku 15, 11314 Tallinn, Estonia Phone: +372 614 0816 Fax: +372 614 0818 E-mail: hirvela@online.ee English, Russian, Estonian	<b>Tõnu NELSAS</b>	<b>AAA Legal Services</b> Tartu Road 16 10117 Tallinn, Estonia P.O. Box 3926 10509 Tallinn, Estonia Phone: +372 660 5910 +372 660 5911 Fax: +372 660 5912 E-mail: aaa@aaa.ee Http://www.aaa.ee English, Russian, Finnish, Estonian
<b>Elle MELLIK</b>	<b>AAA Legal Services</b> Tartu Road 16 10117 Tallinn, Estonia P.O. Box 3926 10509 Tallinn, Estonia Phone: +372 660 5910 +372 660 5911 Fax: +372 660 5912 E-mail: aaa@aaa.ee Http://www.aaa.ee English, Russian, Estonian	<b>Jüri OLT</b>	<b>Patent Agency Käosaar &amp; Co</b> Tähe Str. 94 50107 Tartu, Estonia Phone: +372 738 3051 Fax: +372 738 3055 E-mail: info@kaosaar.ee Http://www.kaosaar.ee English, German, Finnish, Russian, Estonian
<b>Lembit MITT</b>	<b>AAA Legal Services</b> Tartu Road 16 10117 Tallinn, Estonia P.O. Box 3926 10509 Tallinn, Estonia Phone: +372 660 5910 +372 660 5911 Fax: +372 660 5912 E-mail: aaa@aaa.ee Http://www.aaa.ee English, Russian, Estonian	<b>Jaak OSTRAT</b>	<b>Lasvet Ltd.</b> P.O. Box 3136 10505 Tallinn, Estonia Phone: +372 640 6600 Fax: +372 640 6604 E-mail: lasvet@lasvet.ee Http://www.lasvet.ee English, German, Finnish, Russian, Estonian
<b>Ott MOORLAT</b>	<b>Moorlat &amp; Co Ltd.  Patent Bureau</b> P.O. Box 723 12902 Tallinn, Estonia Phone: +372 655 0450 +372 654 2844 Fax: +372 654 2844 E-mail: ott.moorlat@moorlat.ee Http://www.moorlat.ee English, Russian, Estonian	<b>Villu PAVELTS</b>	<b>Lasvet Ltd.</b> P.O. Box 3136 10505 Tallinn, Estonia Phone: +372 640 6600 Fax: +372 640 6604 E-mail: lasvet@lasvet.ee Http://www.lasvet.ee English, Finnish, Russian, Estonian

- Anneli PUNGAS**      **Synest Ltd.**  
P.O. Box 977  
13402 Tallinn, Estonia  
Phone: +372 660 9786  
Fax: +372 660 9787  
E-mail: anneli@synest.ee  
English, German, Russian,  
French, Finnish, Swedish,  
Estonian
- Toom PUNGAS**      **Synest Ltd.**  
P.O. Box 977  
13402 Tallinn, Estonia  
Phone: +372 660 9786  
Fax: +372 660 9787  
E-mail: toom@synest.ee  
English, German, Finnish,  
Russian, Estonian
- Kaie PUUR**      **Patent Agency Käosaar & Co**  
Tähe Str. 94  
50107 Tartu, Estonia  
Phone: +372 738 3051  
Fax: +372 738 3055  
E-mail: info@kaosaar.ee  
Http://www.kaosaar.ee  
English, Russian, Estonian
- Riina PÄRN**      **Intels Ltd.**  
Riia Str. 11-3  
51010 Tartu, Estonia  
Phone: +372 742 0401  
Fax: +372 742 0326  
E-mail: intelses@estpak.ee  
English, Russian,  
Estonian
- Tarmo ROSMAN**      **Rosman and Partners Ltd.**  
P.O. Box 652  
12602 Tallinn, Estonia  
Phone: +372 656 1450  
Fax: +372 656 1450  
E-mail: tarman@cc.ttu.ee  
German, English, Hungarian,  
Russian, Estonian
- Arvo SALUMÄE**      **AMENDE Patent Agency Ltd.**  
Raua 65, 10152 Tallinn, Estonia  
Phone: +372 648 6125  
Fax: +372 641 0174  
E-mail: amende@hot.ee  
English, German, Finnish,  
Russian, Estonian
- Almar SEHVER**      **AAA Legal Services**  
Tartu Road 16  
10117 Tallinn, Estonia  
P.O. Box 3926  
10509 Tallinn, Estonia  
Phone: +372 660 5910  
+372 660 5911  
Fax: +372 660 5912  
E-mail: aaa@aaa.ee  
Http://www.aaa.ee  
English, Russian,  
Estonian
- Harald TEHVER**      **Patendibüroo TURVAJA OÜ**  
Liivalaia 22  
10118 Tallinn, Estonia  
Phone: +372 640 3109  
Fax: +372 640 3105  
E-mail: tehver@turvaja.ee  
Http://www.turvaja.ee  
English, German, Russian,  
Estonian
- Olga TREUFELDT**      **Patendibüroo TURVAJA OÜ**  
Liivalaia 22  
10118 Tallinn, Estonia  
Phone: +372 640 3109  
Fax: +372 640 3105  
E-mail: olga@turvaja.ee  
Http://www.turvaja.ee  
English, Russian, Estonian
- Enn URGAS**      **Patendibüroo TURVAJA OÜ**  
Liivalaia 22  
10118 Tallinn, Estonia  
Phone: +372 640 3109  
Fax: +372 640 3105  
E-mail: urgas@turvaja.ee  
Http://www.turvaja.ee  
English, Russian, Estonian
- Juta-Maris UUSTALU**      **Lasvet Ltd.**  
P.O. Box 3136  
10505 Tallinn, Estonia  
Phone: +372 640 6600  
Fax: +372 640 6604  
E-mail: lasvet@lasvet.ee  
Http://www.lasvet.ee  
English, Russian, Estonian