



EESTI VABARIIK

**T** **EESTI**  
**TÖÖSTUSDISAINI-**  
**LAHENDUSE LEHT**



PATENDIAMETI AMETLIK VÄLJAANNE

**2**  
**2005**  
TALLINN



ISSN 1406-376X

EESTI VABARIIK

**T** EESTI  
**TÖÖSTUSDISAINI-**  
**LAHENDUSE LEHT**

**PATENDIAMETI  
AMETLIK VÄLJAANNE**

**VIII aastakäik**

**Käesolevas numbris  
esitatud andmed  
loetakse avaldatuks  
16. mail 2005. a.**

**2**  
**2005**  
MAI  
TALLINN

Eesti Tööstusdisainilahenduse Lehte antakse välja tööstusdisaini kaitse seaduse (jõustunud 11.01.1998) alusel.  
The Estonian Industrial Design Gazette is the official publication of the Estonian Patent Office.  
Published under Industrial Design Protection Law of the Republic of Estonia (coming into force 11 January 1998).  
Date of publication of the data presented in this issue - 16 May 2005.

Patendiameti  
infoosakond  
Toompuiestee 7  
15041 Tallinn  
Tel 627 7907  
Faks 627 7943  
E-post Info@epa.ee

The Information Department  
of the Estonian Patent Office  
Toompuiestee 7  
15041 Tallinn, ESTONIA  
Phone +372 627 7907  
Fax +372 627 7943  
E-mail Info@epa.ee

Levitaja

Eesti Patendiraamatukogu  
Olevimägi 8/10  
10123 Tallinn  
Tel 641 1248  
Faks 641 1018  
E-post patent@patentlib.ee

Distributor

Estonian Patent Library  
Olevimägi 8/10  
10123 Tallinn, ESTONIA  
Phone +372 641 1248  
Fax +372 641 1018  
E-mail patent@patentlib.ee

## SISUKORD

Andmete identifitseerimise rahvusvahelised numberkoodid (INID-koodid) .....	4
Riikide, teiste ühenduste ja valitsustevaheliste organisatsioonide koodid .....	5
I. REGISTREERITUD TÖÖSTUSDISAINILAHENDUSED .....	6
II. RAHVUSVAHELISELT REGISTREERITUD TÖÖSTUSDISAINILAHENDUSED .....	40
III. REGISTREERINGU KEHTIVUSE PIKENDAMINE .....	97
IV. TÖÖSTUSDISAINILAHENDUSE ÜLEMINEK .....	97
V. REGISTREERINGU JAGAMINE .....	-
VI. MUUD REGISTREERINGU ANDMETE MUUDATUSED .....	97
VII. REGISTREERINGU ANDMETE PARANDUSED .....	-
VIII. TÖÖSTUSDISAINILAHENDUSE LITSENTSIDE REGISTREERIMINE .....	-
IX. TÖÖSTUSDISAINILAHENDUSE PANTIDE REGISTREERIMINE .....	-
X. TUNNISTUSE DUPLIKAADI VÄLJAANDMINE .....	-
XI. TÖÖSTUSDISAINILAHENDUSE KUSTUTAMINE REGISTRIST .....	98
XII. LOENDID .....	99
Registreeritud tööstusdisainilahenduste süstemaatiline loend .....	99
Registreeritud tööstusdisainilahenduste registreerimistaotluste numbriline loend .....	99
Avaldatud rahvusvahelise registreeringu registreerimise otsuse teadete numbriline loend .....	100
XIII. TÖÖSTUSDISAINIALASED ÕIGUSAKTID JA MUU INFO .....	101
Riiklikus patendivolinike registris registreeritud patendivolinike nimekiri .....	101

## CONTENTS

Internationally Agreed Numbers for the Identification of Data (INID Codes) .....	4
List of Codes of States, Other Entities and Intergovernmental Organizations .....	5
I. REGISTERED INDUSTRIAL DESIGNS ....	6
II. INTERNATIONALLY REGISTERED INDUSTRIAL DESIGNS .....	40
III. EXTENSION OF THE REGISTRATION .....	97
IV. TRANSFER OF INDUSTRIAL DESIGN .....	97
V. DIVISION OF THE REGISTRATION. ....	-
VI. OTHER AMENDMENTS TO REGISTRATION DATA .....	97
VII. CORRECTIONS TO REGISTRATION DATA .....	-
VIII. REGISTERING OF LICENSES OF INDUSTRIAL DESIGN .....	-
IX. REGISTERING OF PLEDGES OF INDUSTRIAL DESIGN .....	-
X. ISSUE OF A COPY OF THE INDUSTRIAL DESIGN CERTIFICATE .....	-
XI. DELETION OF INDUSTRIAL DESIGN FROM THE REGISTER .....	98
XII. LISTS .....	99
Systematic List of Registered Industrial Designs .....	99
Numerical List of Registration Applications of Registered Industrial Designs .....	99
Numerical List of Published Notices of Decisions on Registration of the International Registration .....	100
XIII. LEGAL ACTS AND INFORMATION CONCERNING INDUSTRIAL DESIGNS .	101
List of Patent Attorneys, Registered in the Estonian State Register of Patent Attorneys .	105

**ANDMETE IDENTIFITSEERIMISE  
RAHVUSVAHELISED NUMBERKOODID  
(INID-KOODID)  
WIPO Standard ST. 80**

**INTERNATIONALLY AGREED NUMBERS FOR  
THE IDENTIFICATION OF DATA  
(INID CODES)  
WIPO Standard ST. 80**

(11) Registreeringu number	(11) Number of the Registration
(15) Registreerimise kuupäev	(15) Date of the Registration
(18) Registreeringu kehtivuse lõppemise kuupäev	(18) Expected expiration date of the registration
(21) Registreerimistaotluse number	(21) Application Number
(22) Registreerimistaotluse esitamise kuupäev	(22) Application Filing Date
(24) Registreeringu kehtivuse alguse kuupäev	(24) Date from which the Industrial Design right has effected
(28) Variantide arv	(28) Number of Industrial Designs included in the application
(30) Prioriteet	(30) Priority
(51) Rahvusvahelise klassifikatsiooni klassi ja alaklassi number	(51) International Classification for Industrial Designs (class and subclass of the Locarno Classification)
(54) Tööstusdisainilahenduse nimetus	(54) Title of the Industrial Design
(55) Tööstusdisainilahenduse reproduktsioon	(55) Reproduction of the Industrial Design
(72) Tööstusdisainilahenduse autor(id)	(72) Author(s) of Industrial Design
(73) Tööstusdisainilahenduse omanik(ud)	(73) Proprietor(s) of Industrial Design
(74) Patendivolinik või ühine esindaja	(74) Patent Attorney or Common Representative

**RIIKIDE, TEISTE ÜHENDUSTE JA VALITSUSTEVAAHELISTE  
ORGANISATSIOONIDE KOODID**

AD	Andorra	DO	Dominikaani	IT	Itaalia	PT	Portugal
AE	Araabia		Vabariik	JM	Jamaica	PW	Belau
	Ühendemiraadid	DZ	Alžeeria	JO	Jordania	PY	Paraguay
AF	Afganistan	EA	Euraasia	JP	Jaapan	QA	Katar
AG	Antigua ja Barbuda		Patendiorganisat-	KE	Kenya	RO	Rumeenia
AI	Anguilla		sioon (EAPO)	KG	Kõrgõzstan	RU	Venemaa
AL	Albaania	EC	Ecuador	KH	Kambodža	RW	Rwanda
AM	Armeenia	EE	Eesti	KI	Kiribati	SA	Saudi Araabia
AN	Hollandi Antillid	EG	Egiptus	KM	Komoorid	SB	Salomoni Saared
AO	Angola	EH	Lääne-Sahara	KN	Saint Kitts ja Nevis	SC	Seišellid
AP	Aafrika Regionaalne	EM	Siseturu	KP	Põhja-Korea	SD	Sudaan
	Tööstusomandi Orga-		Ühtlustamise	KR	Lõuna-Korea	SE	Rootsi
	nisatsioon (ARIPO)		Amet (kaubamärgid	KW	Kuveit	SG	Singapur
AR	Argentina		ja tööstusdisaini-	KY	Kaimanisaared	SH	Saint Helena
AS	Ameerika Samoa		lahendused)(OHIM)	KZ	Kasahstan	SI	Sloveenia
AT	Austria	EP	Euroopa	LA	Laos	SK	Slovakkia
AU	Austraalia		Patendiamet (EPO)	LB	Liibanon	SL	Sierra Leone
AW	Aruba	ER	Eritrea	LC	Saint Lucia	SM	San Marino
AZ	Aserbaidžaan	ES	Hispaania	LI	Liechtenstein	SN	Senegal
BA	Bosnia ja	ET	Etiopia	LK	Sri Lanka	SO	Somaalia
	Hertsegoviina	FI	Soome	LR	Libeeria	SR	Suriname
BB	Barbados	FJ	Fidži	LS	Lesotho	ST	São Tomé ja Príncipe
BD	Bangladesh	FK	Falklandi (Malviini)	LT	Leedu	SV	El Salvador
BE	Belgia		saared	LU	Luksemburg	SY	Süüria
BF	Burkina Faso	FM	Mikroneesia	LV	Läti	SZ	Svaasimaa
BG	Bulgaaria	FO	Fääri saared	LY	Liibüa	TC	Turks ja Caicos
BH	Bahrein	FR	Prantsusmaa	MA	Maroko	TD	Tšaad
BI	Burundi	GA	Gabon	MC	Monaco	TG	Togo
BJ	Benin	GB	Ühendkuningriik	MD	Moldova	TH	Tai
BM	Bermuda		(Suurbritannia)	MG	Madagaskar	TJ	Tadžikistan
BN	Brunei	GC	Pärsia Lahe	MH	Marshalli Saared	TM	Türkmenistan
BO	Boliivia		Koostöönõukogu	MK	Makedoonia	TN	Tuneesia
BR	Brasiilia	GD	Grenada	ML	Mali	TO	Tonga
BS	Bahama	GE	Gruusia	MM	Myanmar (Birma)	TL	Ida-Timor
BT	Bhutan	GH	Ghana	MN	Mongoolia	TR	Türgi
BV	Bouvet' saar	GI	Gibraltar	MO	Macao	TT	Trinidad ja Tobago
BW	Botswana	GL	Gröönimaa	MP	Põhja-Mariaanid	TV	Tuvalu
BX	Beneluxi	GM	Gambia	MR	Mauritaania	TW	Taiwan (Hiina provints)
	Kaubamärgiamet	GN	Guinea	MS	Montserrat	TZ	Tansaania
	(BBM) ja Beneluxi	GQ	Ekvatoriaal-Guinea	MT	Malta	UA	Ukraina
	Tööstusdisainilahen-	GR	Kreeka	MU	Mauritius	UG	Uganda
	duste Amet (BBDM)	GS	Lõuna-Georgia ja	MV	Maldiiivid	US	Ameerika
BY	Valgevene		Lõuna-Sandwichi	MW	Malawi		Ühendriigid
BZ	Belize		saared	MX	Mehhiko	UY	Uruguay
CA	Kanada	GT	Guatemala	MY	Malaisia	UZ	Usbekistan
CF	Kesk-Aafrika	GW	Guinea-Bissau	MZ	Mosambiik	VA	Vatikan (Püha Tool)
	Vabariik	GY	Guyana	NA	Namiibia	VC	Saint Vincent ja
CG	Kongo	HK	Hongkong	NE	Niger		Grenadiinid
CH	Šveits	HN	Honduras	NG	Nigeeria	VE	Venezuela
CI	Côte d'Ivoire	HR	Horvaatia	NI	Nicaragua	VG	Neitsisaared
CK	Cooki saared	HT	Haiti	NL	Holland	VN	Vietnam
CL	Tšiili	HU	Ungari	NO	Norra	VU	Vanuatu
CM	Kamerun	IB	Ülemaailmse	NP	Nepal	WO	Ülemaailmne
CN	Hiina		Intellektuaalomandi	NR	Nauru		Intellektuaalomandi
CO	Kolumbia		Organisatsiooni	NZ	Uus-Meremaa		Organisatsioon
CR	Costa Rica		(WIPO) Rahvus-	OA	Aafrika Intellektuaal-		(WIPO) (Rahvus-
CS	Serbia ja Montenegro		vaheline Büroo		omandi Organisat-		vaheline Büroo)
CU	Kuuba	ID	Indoneesia		sioon (OAPI)	WS	Samoa
CV	Cabo Verde	IE	Iiri	OM	Omaan	YE	Jeemen
CY	Küpros	IL	Iisrael	PA	Panama	ZA	Lõuna-Aafrika Vabariik
CZ	Tšehhi	IM	Man'i saar	PE	Peruu	ZM	Sambia
DE	Saksamaa	IN	India	PG	Paapua Uus-Guinea	ZR	Zaire
DJ	Djibouti	IQ	Iraak	PH	Filipiinid	ZW	Zimbabwe
DK	Taani	IR	Iraan	PK	Pakistan		
DM	Dominica	IS	Island	PL	Poola		

## **I. REGISTREERITUD TÖÖSTUSDISAINILAHENDUSED**

Avaldatakse "Tööstusdisaini kaitse seaduse" § 55<sup>1</sup> lõike 7 alusel.

Patendiamet ei ole kontrollinud tööstusdisainilahenduse uudsust ja eristatavust tulenevalt "Tööstusdisaini kaitse seaduse" § 31 lõike 2 punktist 1.

(11) <b>Registreeringu number</b>	<b>01040</b>	(51) Klass: <b>25-01</b>
(21) <b>Taotluse number</b>	D200400070	
(15) <b>Registreerimise päev</b>	16.05.2005	
(22) <b>Esitamise päev</b>	07.06.2004	
(24) <b>Registreeringu kehtivuse alguse päev</b>	07.06.2004	
(18) <b>Registreeringu kehtivuse lõppemise päev</b>	07.06.2009	
(28) <b>Variantide arv</b>	1	
(72) <b>Autor</b>	Leonardo Meigas, Kentmanni 10-2, 10116 Tallinn, EE	
(73) <b>Omanik</b>	Leonardo Meigas, Kentmanni 10-2, 10116 Tallinn, EE	

(54) **Nimetus** **Reljeefne dekoratiivplaat**

(55) **Reproduktsoon**

01040-01

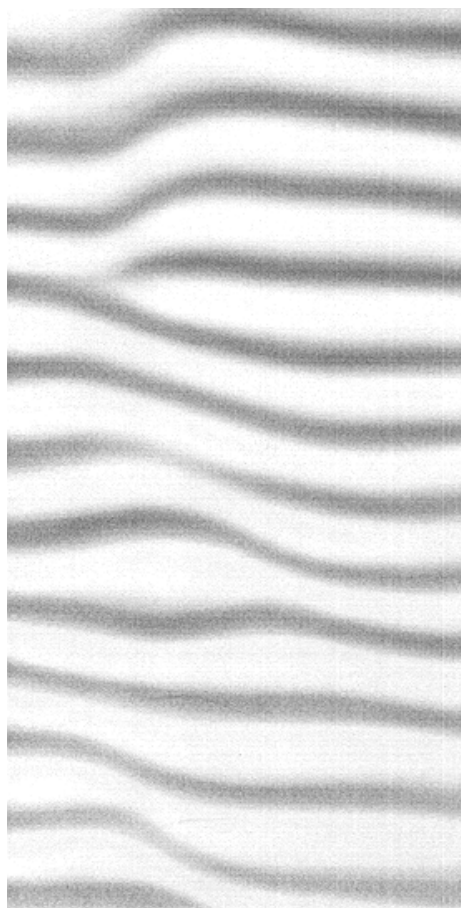



- (11) **Registreeringu number** **01041** (51) Klass: **14-03**
- (21) **Taotluse number** D200400106
- (15) **Registreerimise päev** 16.05.2005
- (22) **Esitamise päev** 29.09.2004
- (24) **Registreeringu kehtivuse alguse päev** 29.09.2004
- (18) **Registreeringu kehtivuse lõppemise päev** 29.09.2009
- (28) **Variantide arv** 1
- (30) **Prioriteediandmed** 29/201,894, 29.03.2004, US
- (72) **Autor** Wei-Jong William Sheu, 5727 Canoga Avenue, Apt. 368, Woodland Hills, CA 91367, US
- (73) **Omanik** Nokia Corporation, Keilalahdentie 4, FIN-02150 Espoo, FI
- (74) **Patendivolinik või ühine esindaja** Kaie Puur
- (54) **Nimetus** **Käsitelefoni klaviatuur / klaviatuuriklahvide paigutus**
- (55) **Reproduktsoon**

01041-01

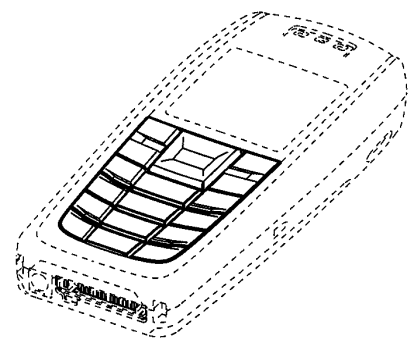
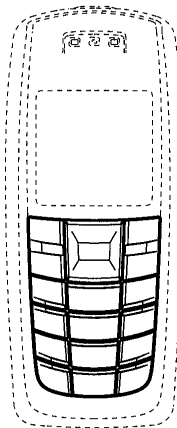
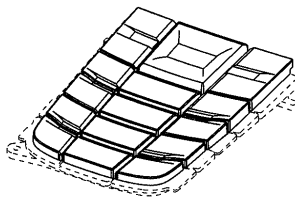
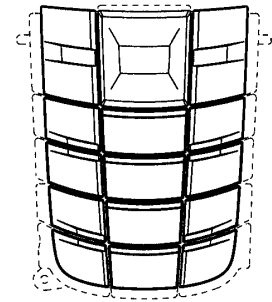
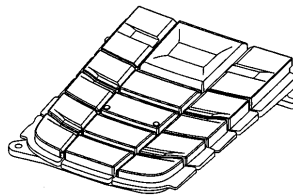
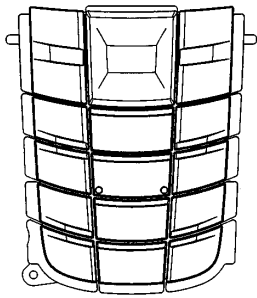

- (11) **Registreeringu number** **01042**
- (21) **Taotluse number** D200400107
- (15) **Registreerimise päev** 16.05.2005
- (22) **Esitamise päev** 29.09.2004
- (24) **Registreeringu kehtivuse alguse päev** 29.09.2004
- (18) **Registreeringu kehtivuse lõppemise päev** 29.09.2009
- (28) **Variantide arv** 1
- (30) **Prioriteediandmed** 29/201,894, 29.03.2004, US
- (72) **Autor** Wei-Jong William Sheu, 5727 Canoga Avenue, Apt. 368, Woodland Hills, CA 91367, US
- (73) **Omanik** Nokia Corporation, Keilalahdentie 4, FIN-02150 Espoo, FI
- (74) **Patendivolinik või ühine esindaja** Kaie Puur

(51) Klass: **14-03**(54) **Nimetus** **Käsitelefon**(55) **Reproduktsoon**

01042-01

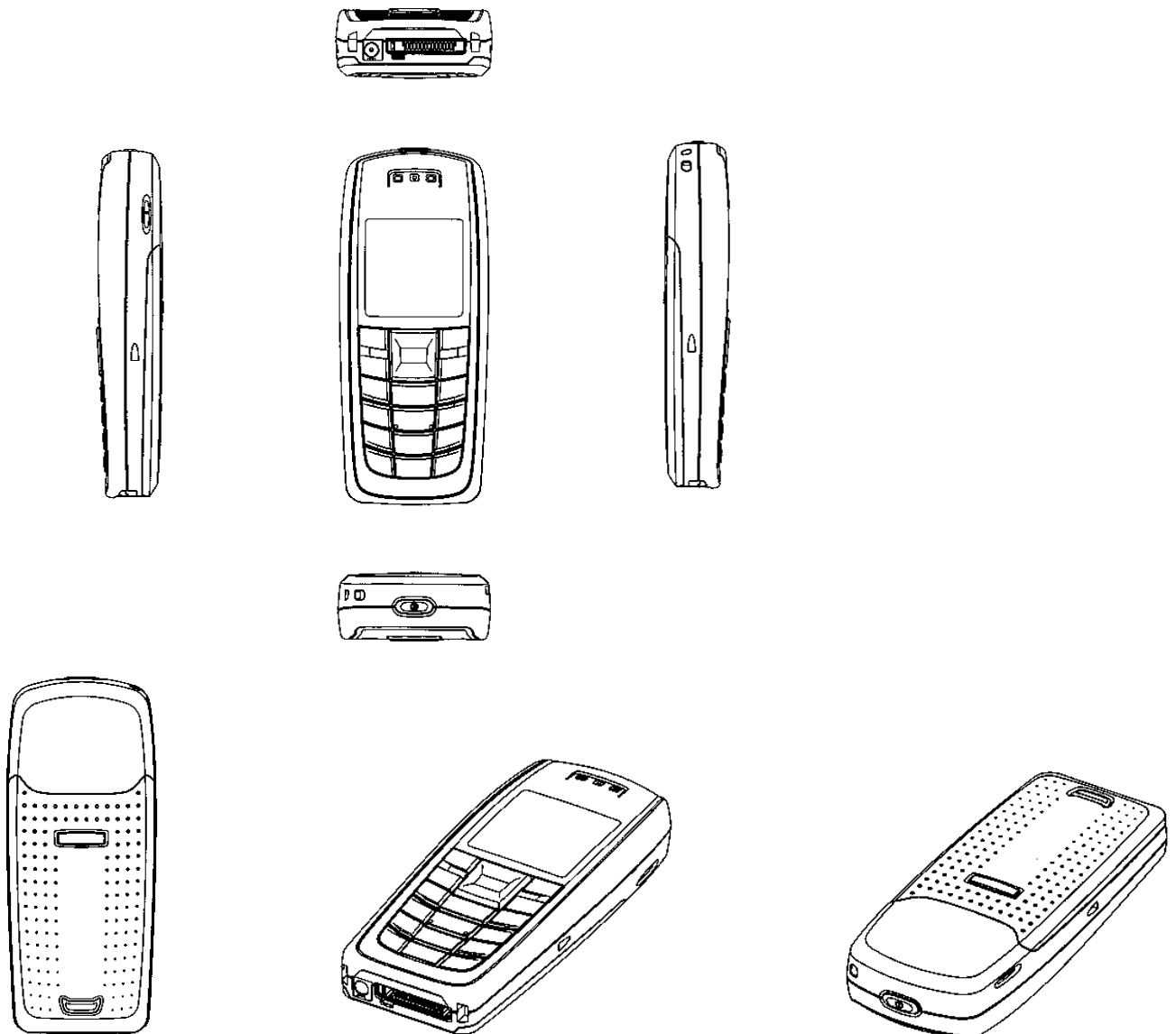

(11) Registreeringu number	<b>01043</b>	(51) Klass: <b>14-03</b>
(21) Taotluse number	D200400108	
(15) Registreerimise päev	16.05.2005	
(22) Esitamise päev	29.09.2004	
(24) Registreeringu kehtivuse alguse päev	29.09.2004	
(18) Registreeringu kehtivuse lõppemise päev	29.09.2009	
(28) Variantide arv	1	
(30) Prioriteediandmed	29/201,894, 29.03.2004, US	
(72) Autor	Wei-Jong William Sheu, 5727 Canoga Avenue, Apt. 368, Woodland Hills, CA 91367, US	
(73) Omanik	Nokia Corporation, Keilalahdentie 4, FIN-02150 Espoo, FI	
(74) Patendivolinik või ühine esindaja	Kaie Puur	

(54) Nimetus **Käsitelefoni esipaneel / esiosa**

(55) Reproduktsoon

01043-01

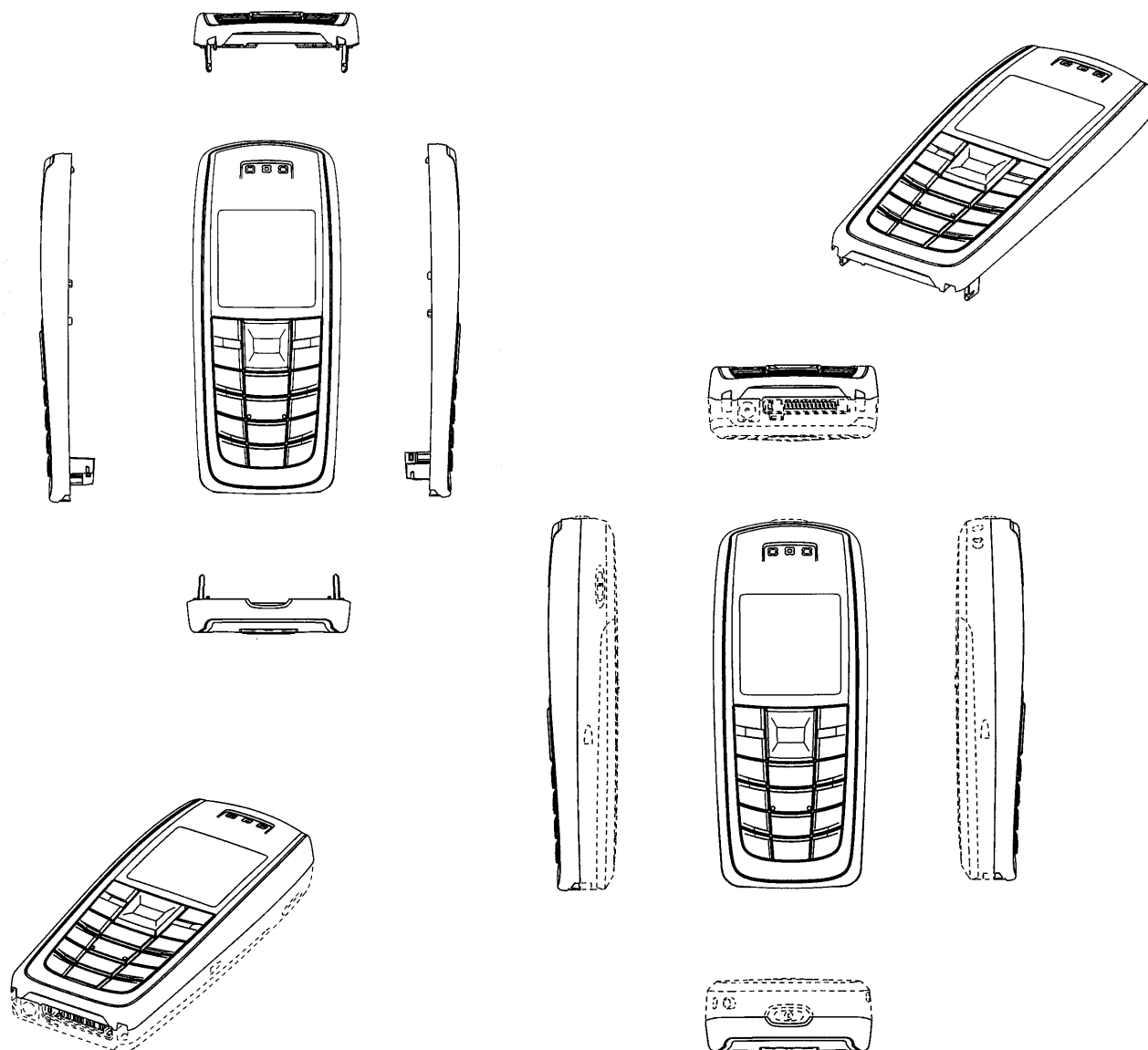

(11) **Registreeringu number** **01044**

(51) Klass: **06-06**

(21) **Taotluse number** D200400146

(15) **Registreerimise päev** 16.05.2005

(22) **Esitamise päev** 27.12.2004

(24) **Registreeringu kehtivuse alguse päev** 27.12.2004

(18) **Registreeringu kehtivuse lõppemise päev** 27.12.2009

(28) **Variantide arv** 1

(72) **Autor** Vladimir Oleinik, Kauba 3A, 11312 Tallinn, EE

(73) **Omanik** AS Ühinenud Depood, Kauba 3A, 11312 Tallinn, EE

(74) **Patendivolinik või ühine esindaja** Reet Maasikamäe

(54) **Nimetus** **Radiaatori kate**

(55) **Reproduktsoon**

01044-01



(11) Registreeringu number	<b>01045</b>	(51) Klass: <b>14-03</b>
(21) Taotluse number	D200400123	
(15) Registreerimise päev	16.05.2005	
(22) Esitamise päev	11.11.2004	
(24) Registreeringu kehtivuse alguse päev	11.11.2004	
(18) Registreeringu kehtivuse lõppemise päev	11.11.2009	
(28) Variantide arv	1	
(30) Prioriteediandmed	M20040103, 14.06.2004, FI	
(72) Autor	Ilkka Husgafvel, Freesenkatu 1 A 9, 00100 Helsinki, FI	
(73) Omanik	Nokia Corporation, Keilalahdentie 4, FIN-02150 Espoo, FI	
(74) Patendivolinik või ühine esindaja	Jüri Käosaar	

(54) Nimetus **Käsitelefon**

(55) Reproduktsoon

01045-01

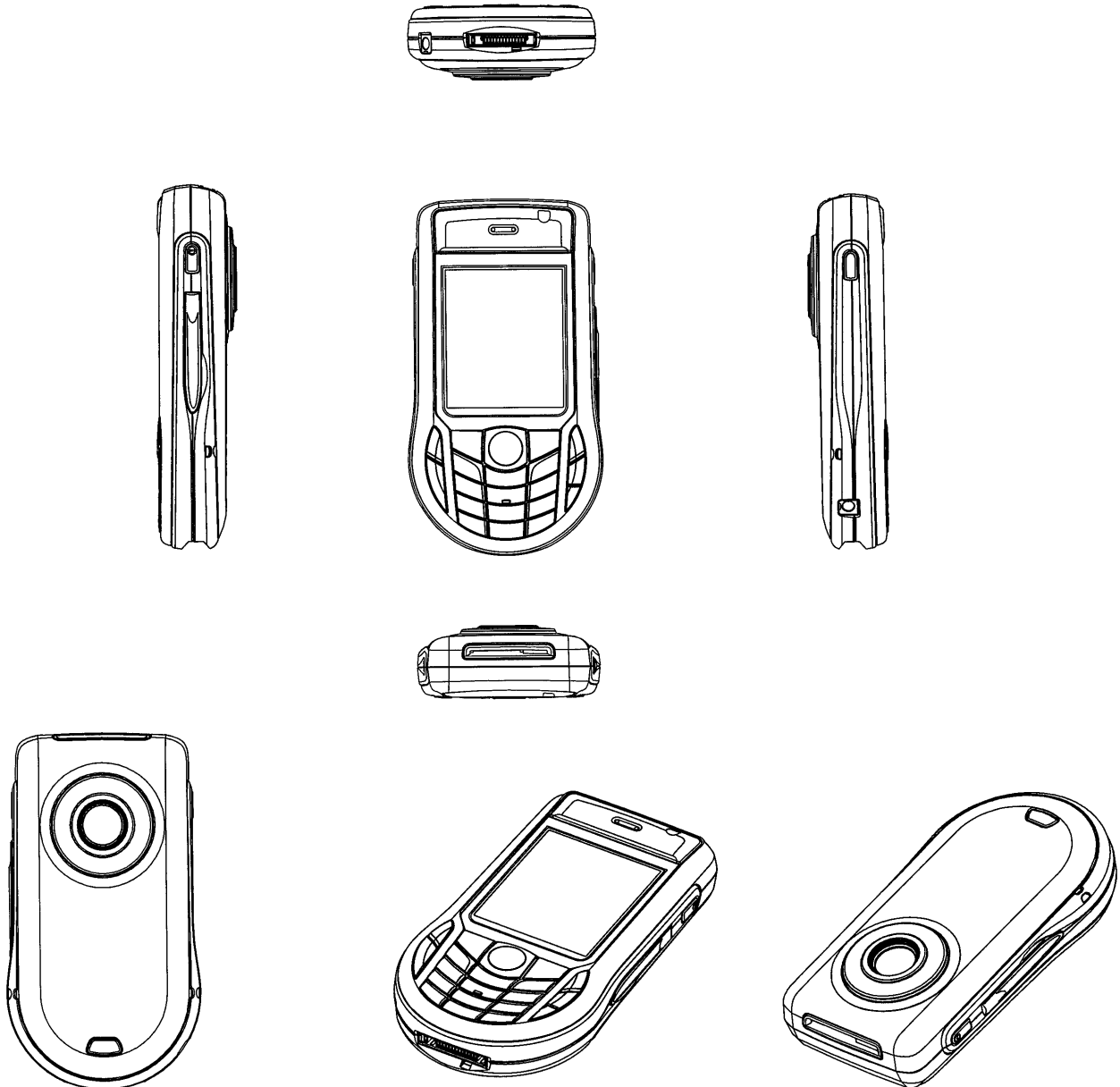

(11) Registreeringu number	<b>01046</b>	(51) Klass: <b>14-03</b>
(21) Taotluse number	D200400125	
(15) Registreerimise päev	16.05.2005	
(22) Esitamise päev	11.11.2004	
(24) Registreeringu kehtivuse alguse päev	11.11.2004	
(18) Registreeringu kehtivuse lõppemise päev	11.11.2009	
(28) Variantide arv	1	
(30) Prioriteediandmed	M20040103, 14.06.2004, FI	
(72) Autor	Ilkka Husgafvel, Freesenkatu 1 A 9, 00100 Helsinki, FI	
(73) Omanik	Nokia Corporation, Keilalahdentie 4, FIN-02150 Espoo, FI	
(74) Patendivolinik või ühine esindaja	Jüri Käosaar	

(54) Nimetus **Käsitelefoni tagapaneel**

(55) Reproduktsoon

01046-01

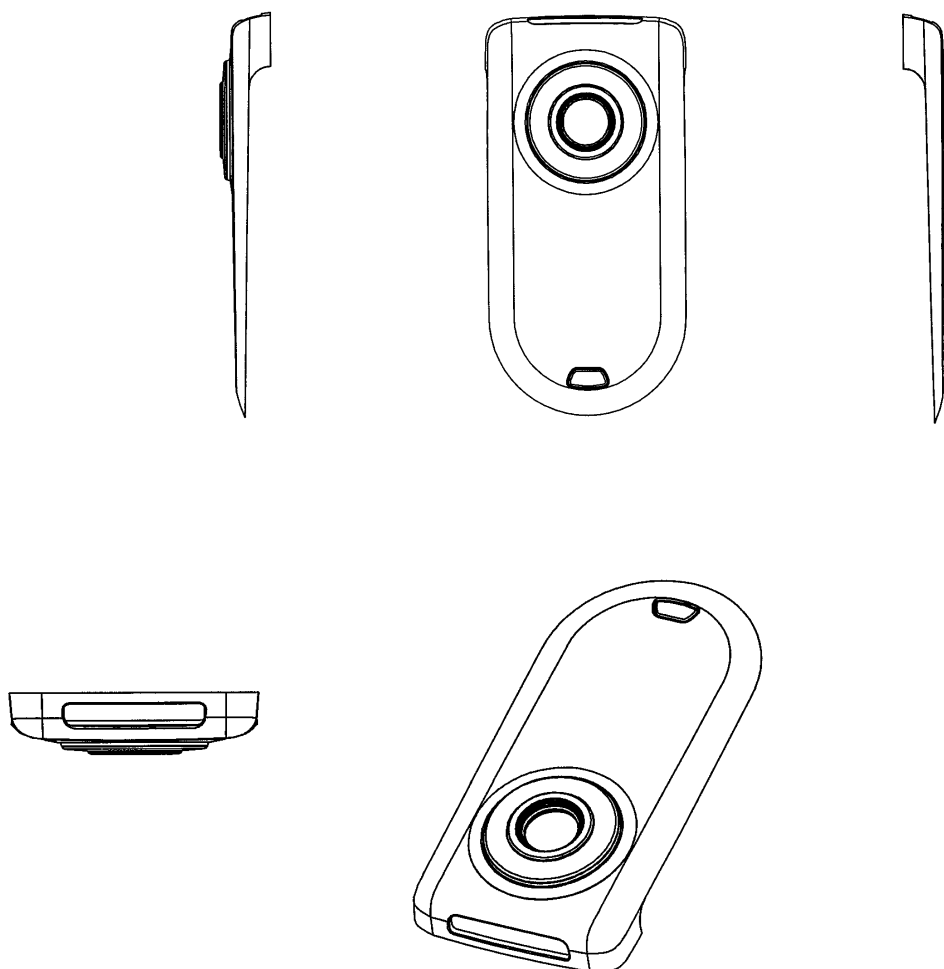

(11) **Registreeringu number** **01047**

(51) Klass: **09-01**

(21) **Taotluse number** D200400133

(15) **Registreerimise päev** 16.05.2005

(22) **Esitamise päev** 03.12.2004

(24) **Registreeringu kehtivuse alguse päev** 03.12.2004

(18) **Registreeringu kehtivuse lõppemise päev** 03.12.2009

(28) **Variantide arv** 1

(72) **Autor** László Pecznik, Mészáros L. u. 58. Te/5, 6200 Kiskőrös, HU

(73) **Omanik** Boranal Borászati és Kereskedelmi Kft., Középece 1, 6200 Kiskőrös, HU

(74) **Patendivolinik või ühine esindaja** Jüri Käosaar

(54) **Nimetus** **Veinipudel**

(55) **Reproduktsoon**

01047-01

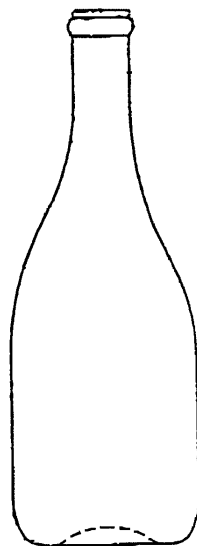
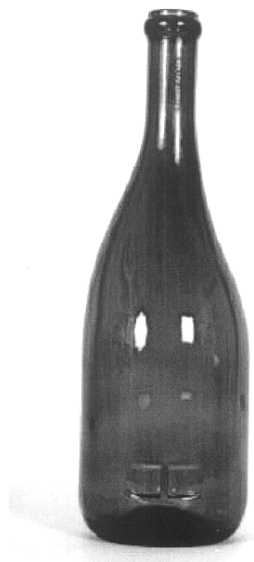

(11) Registreeringu number	<b>01048</b>	(51) Klass: <b>14-03</b>
(21) Taotluse number	D200400134	
(15) Registreerimise päev	16.05.2005	
(22) Esitamise päev	07.12.2004	
(24) Registreeringu kehtivuse alguse päev	07.12.2004	
(18) Registreeringu kehtivuse lõppemise päev	07.12.2009	
(28) Variantide arv	1	
(30) Prioriteediandmed	29/206,944, 07.06.2004, US	
(72) Autor	Thomas Arbisi, 791 Danvers Circle, Newbury Park, CA 91320, US	
(73) Omanik	Nokia Corporation, Keilalahdentie 4, FIN-02150 Espoo, FI	
(74) Patendivolinik või ühine esindaja	Kaie Puur	

(54) Nimetus **Käsitelefon**

(55) Reproduktsoon

01048-01

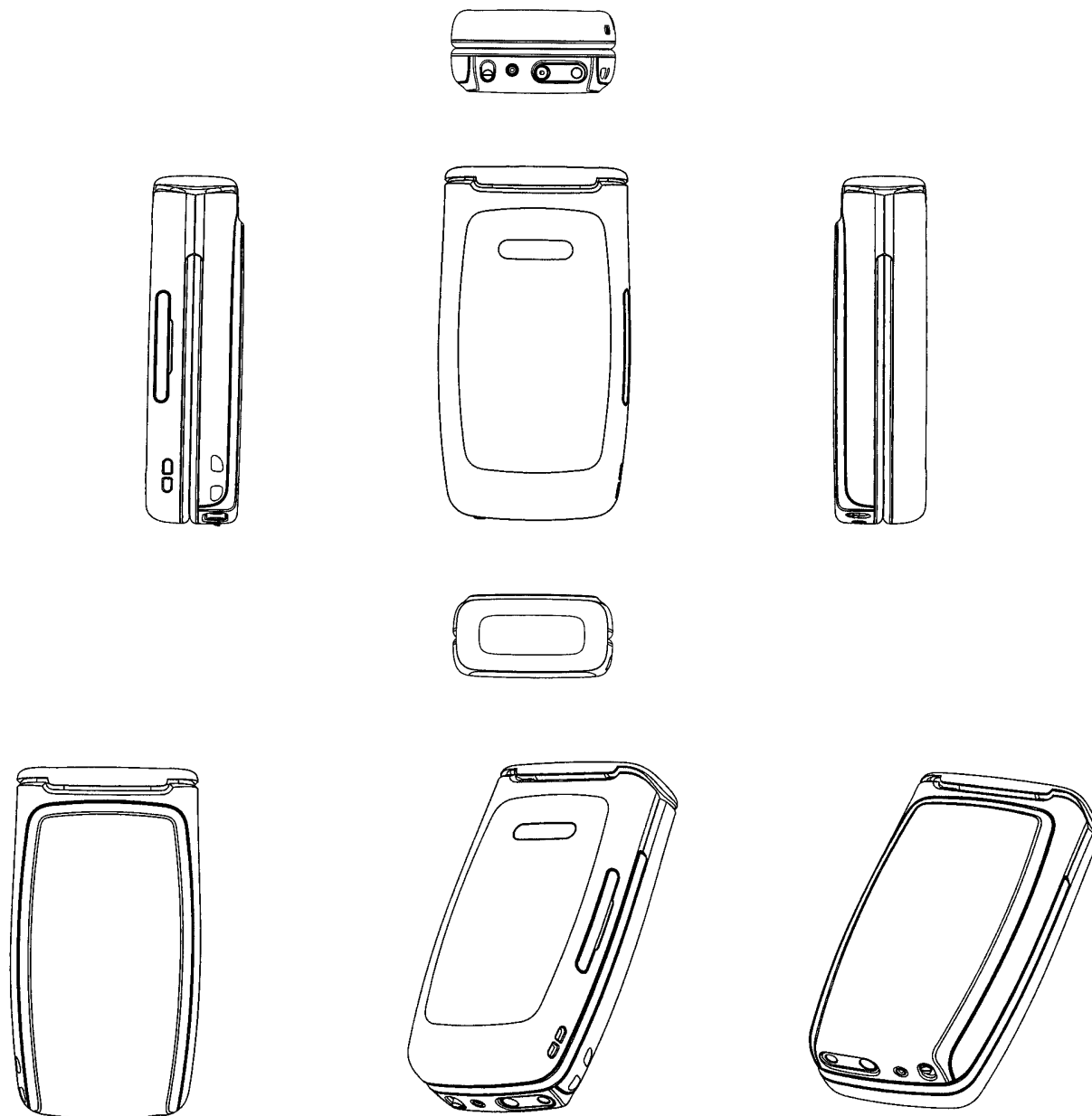



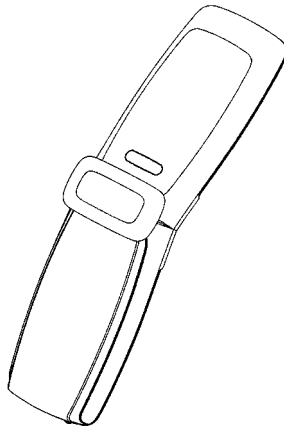
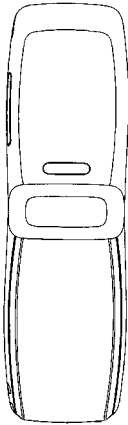
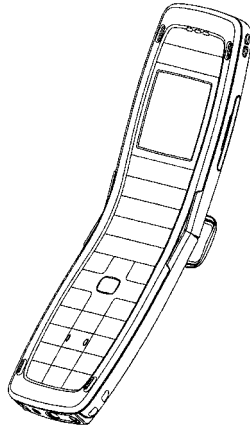
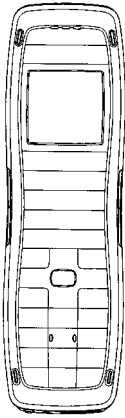

- (11) **Registreeringu number** **01049** (51) Klass: **14-03**
- (21) **Taotluse number** D200400138
- (15) **Registreerimise päev** 16.05.2005
- (22) **Esitamise päev** 14.12.2004
- (24) **Registreeringu kehtivuse alguse päev** 14.12.2004
- (18) **Registreeringu kehtivuse lõppemise päev** 14.12.2009
- (28) **Variantide arv** 1
- (30) **Prioriteediandmed** 29/207,320, 14.06.2004, US
- (72) **Autor** Shiho Nakajima, 4-2-13-701 Todoroki, Setagaya-ku, 158-0082 Tokyo, JP  
Robert Shepherd, 5830 Reseda BI, #143, Tarzana, CA 91356, US
- (73) **Omanik** Nokia Corporation, Keilalahdentie 4, FIN-02150 Espoo, FI
- (74) **Patendivolinik või ühine esindaja** Jüri Käosaar
- (54) **Nimetus** **Käsitelefon**
- (55) **Reproduktsoon**

01049-01

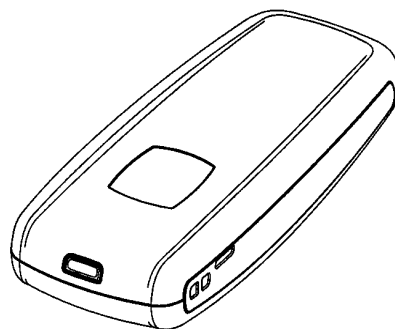
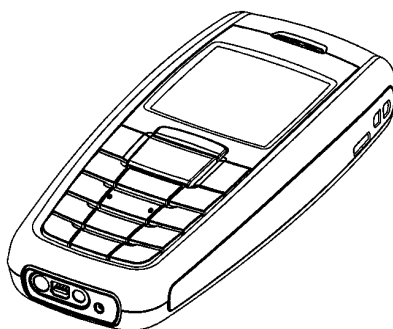
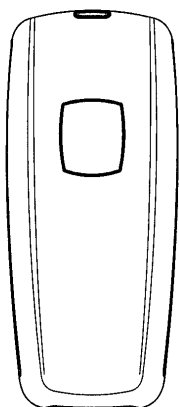
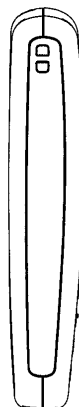
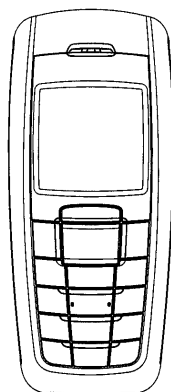
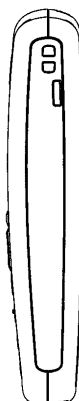
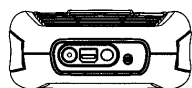

(11) Registreeringu number	<b>01050</b>	(51) Klass: <b>14-03</b>
(21) Taotluse number	D200400139	
(15) Registreerimise päev	16.05.2005	
(22) Esitamise päev	14.12.2004	
(24) Registreeringu kehtivuse alguse päev	14.12.2004	
(18) Registreeringu kehtivuse lõppemise päev	14.12.2009	
(28) Variantide arv	1	
(30) Prioriteediandmed	29/207,323, 14.06.2004, US	
(72) Autor	Shiho Nakajima, 4-2-13-701 Todoroki, Setagaya-ku, 158-0082 Tokyo, JP Robert Shepherd, 5830 Reseda BI, #143, Tarzana, CA 91356, US	
(73) Omanik	Nokia Corporation, Keilalahdentie 4, FIN-02150 Espoo, FI	
(74) Patendivolinik või ühine esindaja	Jüri Käosaar	

(54) Nimetus **Käsitelefoni klaviatuuri klahvide paigutus / klaviatuur**

(55) Reproduktsoon

01050-01

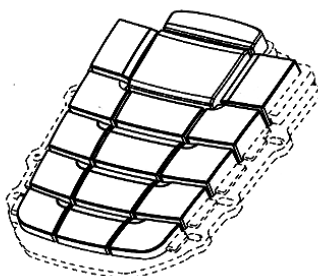
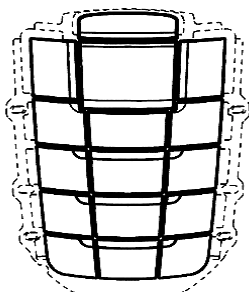
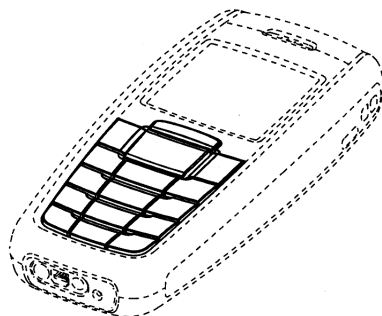
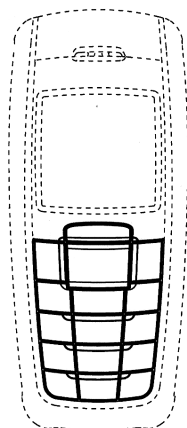

(11) Registreeringu number	<b>01051</b>	(51) Klass: <b>14-03</b>
(21) Taotluse number	D200400140	
(15) Registreerimise päev	16.05.2005	
(22) Esitamise päev	14.12.2004	
(24) Registreeringu kehtivuse alguse päev	14.12.2004	
(18) Registreeringu kehtivuse lõppemise päev	14.12.2009	
(28) Variantide arv	1	
(30) Prioriteediandmed	29/207,323, 14.06.2004, US	
(72) Autor	Shiho Nakajima, 4-2-13-701 Todoroki, Setagaya-ku, 158-0082 Tokyo, JP Robert Shepherd, 5830 Reseda BI, #143, Tarzana, CA 91356, US	
(73) Omanik	Nokia Corporation, Keilalahdentie 4, FIN-02150 Espoo, FI	
(74) Patendivolinik või ühine esindaja	Jüri Käosaar	

(54) Nimetus **Käsitelefoni tagapaneel**

(55) Reproduktsoon

01051-01

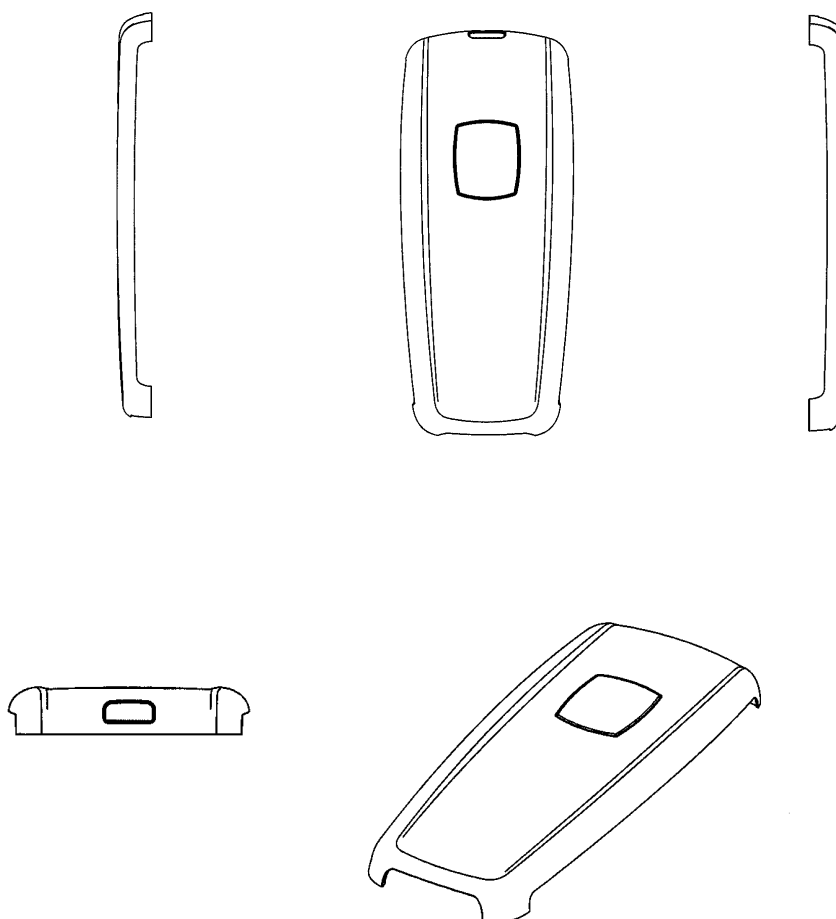

(11) Registreeringu number	<b>01052</b>	(51) Klass: <b>14-03</b>
(21) Taotluse number	D200400141	
(15) Registreerimise päev	16.05.2005	
(22) Esitamise päev	14.12.2004	
(24) Registreeringu kehtivuse alguse päev	14.12.2004	
(18) Registreeringu kehtivuse lõppemise päev	14.12.2009	
(28) Variantide arv	1	
(30) Prioriteediandmed	29/207,323, 14.06.2004, US	
(72) Autor	Shiho Nakajima, 4-2-13-701 Todoroki, Setagaya-ku, 158-0082 Tokyo, JP Robert Shepherd, 5830 Reseda BI, #143, Tarzana, CA 91356, US	
(73) Omanik	Nokia Corporation, Keilalahdentie 4, FIN-02150 Espoo, FI	
(74) Patendivolinik või ühine esindaja	Jüri Käosaar	

(54) Nimetus **Käsitelefoni esipaneel / käsitelefoni esiosa**

(55) Reproduktsoon

01052-01

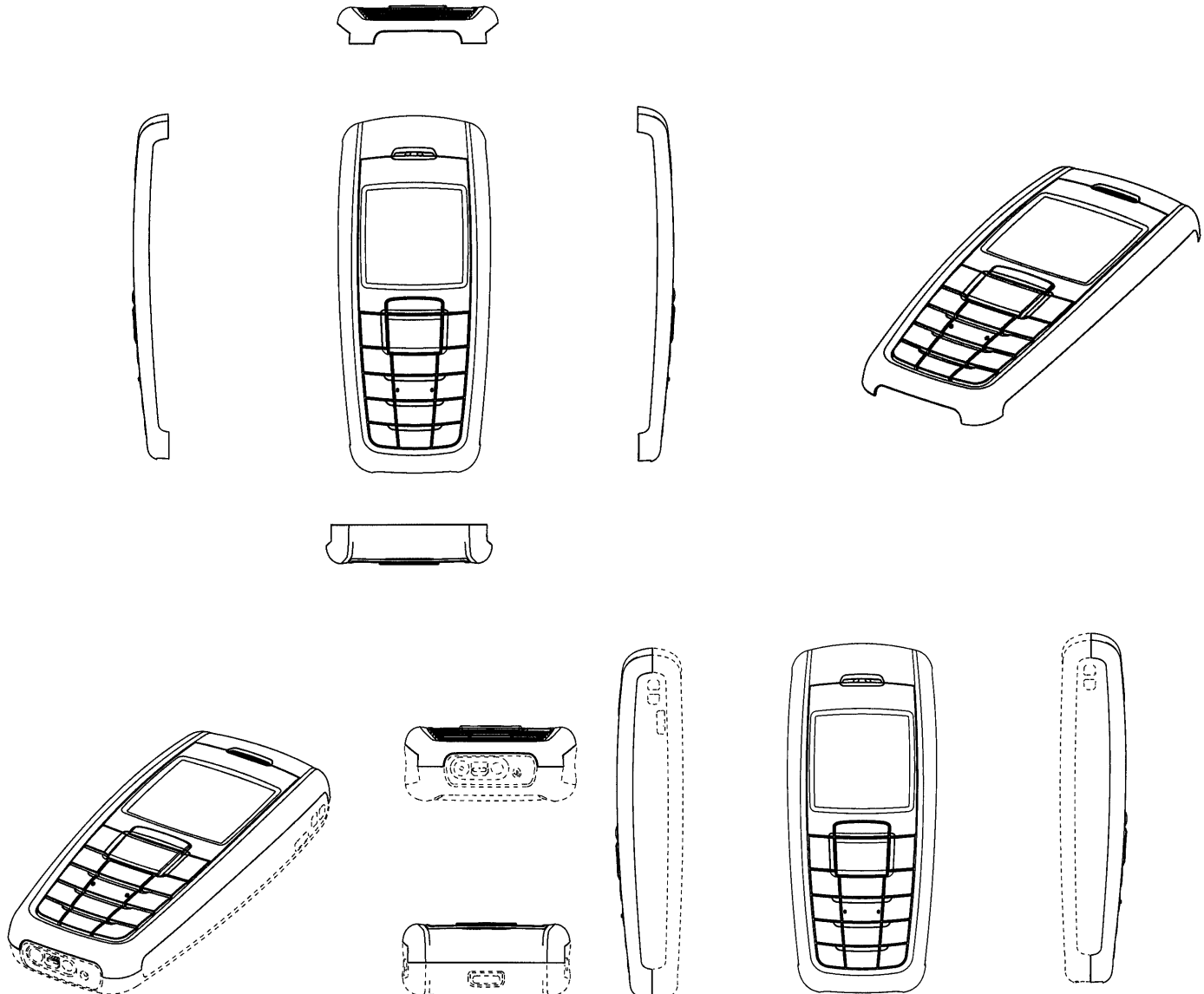

- (11) **Registreeringu number** **01053**
- (21) **Taotluse number** D200400144
- (15) **Registreerimise päev** 16.05.2005
- (22) **Esitamise päev** 27.12.2004
- (24) **Registreeringu kehtivuse alguse päev** 27.12.2004
- (18) **Registreeringu kehtivuse lõppemise päev** 27.12.2009
- (28) **Variantide arv** 1
- (72) **Autor** Vladimir Oleinik, Kauba 3A, 11312 Tallinn, EE
- (73) **Omanik** AS Ühinenud Depood, Kauba 3A, 11312 Tallinn, EE
- (74) **Patendivolinik või ühine esindaja** Reet Maasikamäe

(51) Klass: **25-02**

(54) **Nimetus** **Laemoodul**

(55) **Reproduktsoon**

01053-01



(11) Registreeringu number	<b>01054</b>	(51) Klass: <b>23-02</b>
(21) Taotluse number	D200400145	
(15) Registreerimise päev	16.05.2005	
(22) Esitamise päev	27.12.2004	
(24) Registreeringu kehtivuse alguse päev	27.12.2004	
(18) Registreeringu kehtivuse lõppemise päev	27.12.2009	
(28) Variantide arv	1	
(72) Autor	Vladimir Oleinik, Kauba 3A, 11312 Tallinn, EE	
(73) Omanik	AS Ühinenud Depood, Kauba 3A, 11312 Tallinn, EE	
(74) Patendivolinik või ühine esindaja	Reet Maasikamäe	

(54) Nimetus **Valamu**

(55) Reproduktsoon

01054-01



(11) **Registreeringu number** **01055**

(51) Klass: **14-03**

(21) **Taotluse number** D200400124

(15) **Registreerimise päev** 16.05.2005

(22) **Esitamise päev** 11.11.2004

(24) **Registreeringu kehtivuse alguse päev** 11.11.2004

(18) **Registreeringu kehtivuse lõppemise päev** 11.11.2009

(28) **Variantide arv** 1

(30) **Prioriteediandmed** M20040103, 14.06.2004, FI

(72) **Autor** Ilkka Husgafvel, Freesenkatu 1 A 9, 00100 Helsinki, FI

(73) **Omanik** Nokia Corporation, Keilalahdentie 4, FIN-02150 Espoo, FI

(74) **Patendivolinik või ühine esindaja** Jüri Käosaar

(54) **Nimetus** **Käsitelefoni esipaneel / esiosa**

(55) **Reproduktsoon**

01055-01

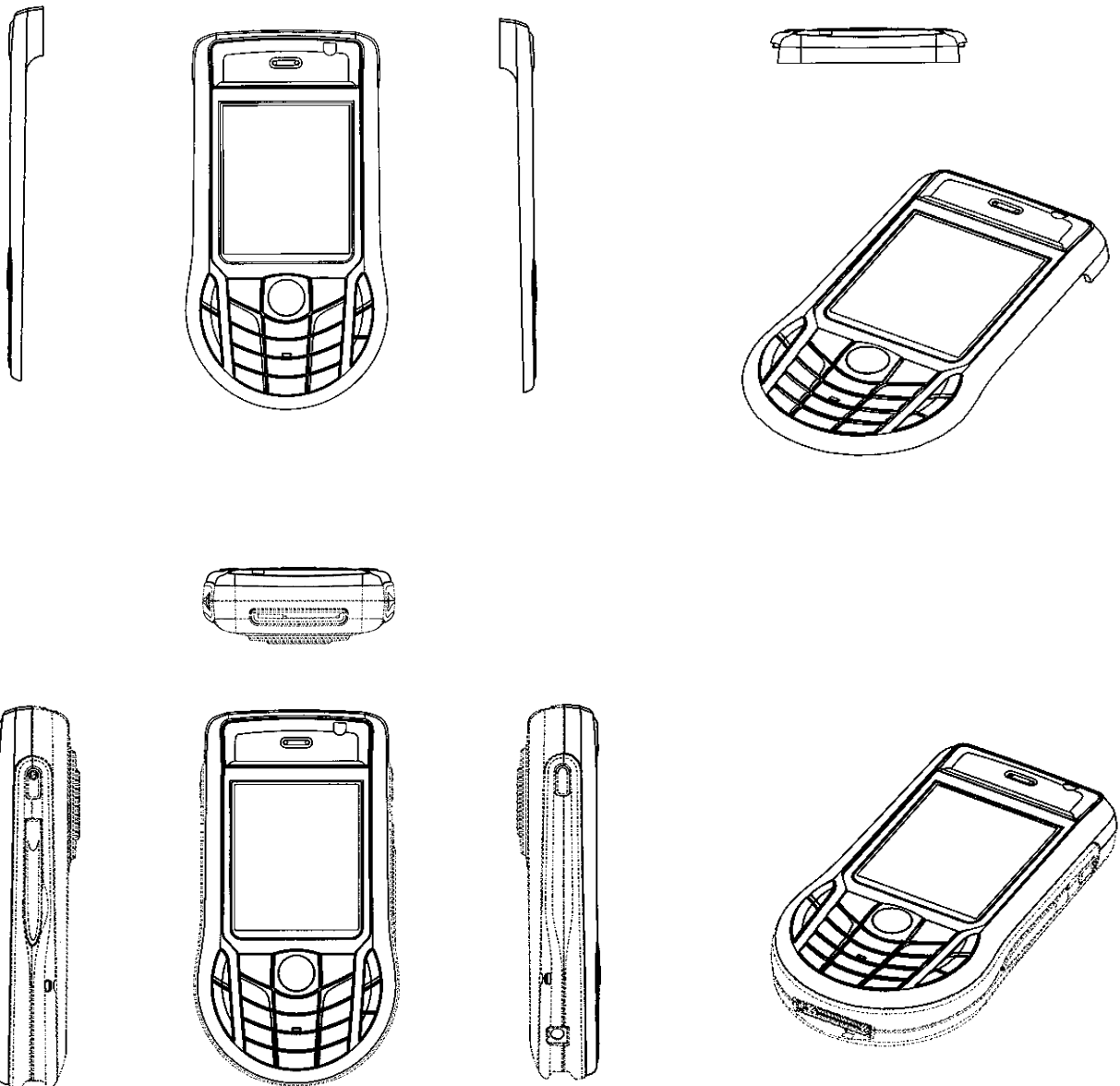



(11) Registreeringu number	<b>01056</b>	(51) Klass: <b>14-03</b>
(21) Taotluse number	D200400126	
(15) Registreerimise päev	16.05.2005	
(22) Esitamise päev	11.11.2004	
(24) Registreeringu kehtivuse alguse päev	11.11.2004	
(18) Registreeringu kehtivuse lõppemise päev	11.11.2009	
(28) Variantide arv	1	
(30) Prioriteediandmed	M20040103, 14.06.2004, FI	
(72) Autor	Ilkka Husgafvel, Freesenkatu 1 A 9, 00100 Helsinki, FI	
(73) Omanik	Nokia Corporation, Keilalahdentie 4, FIN-02150 Espoo, FI	
(74) Patendivolinik või ühine esindaja	Jüri Käosaar	

(54) Nimetus **Klaviatuuriklahvide paigutus / käsitelefone klaviatuur**

(55) Reproduktsoon

01056-01

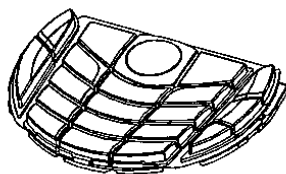
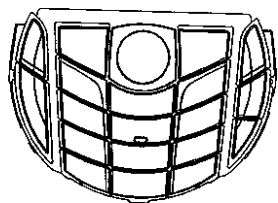
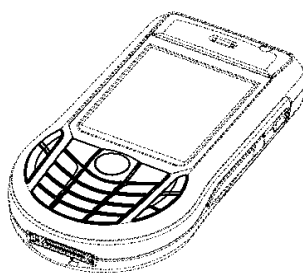
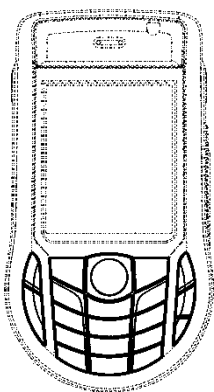

(11) Registreeringu number	<b>01057</b>
(21) Taotluse number	D200500001
(15) Registreerimise päev	16.05.2005
(22) Esitamise päev	11.02.2005
(24) Registreeringu kehtivuse alguse päev	11.02.2005
(18) Registreeringu kehtivuse lõppemise päev	11.02.2010
(28) Variantide arv	1
(72) Autor	Arne Sampka, Liiva 4-23, 72712 Paide, EE
(73) Omanik	Arne Sampka, Liiva 4-23, 72712 Paide, EE

(51) Klass: **07-02**(54) Nimetus ***Barbecue ahi***

(55) Reproduktsoon

01057-01

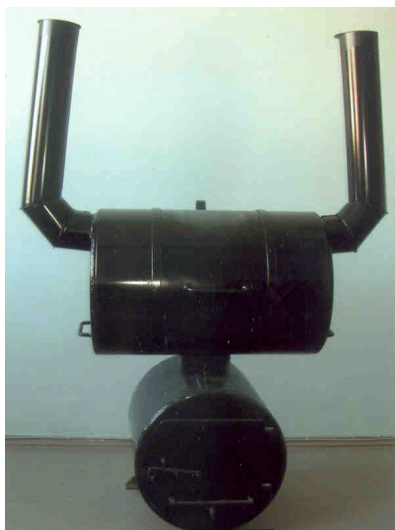

(11) Registreeringu number	<b>01058</b>	(51) Klass: <b>09-01</b>
(21) Taotluse number	D200500003	
(15) Registreerimise päev	16.05.2005	
(22) Esitamise päev	14.02.2005	
(24) Registreeringu kehtivuse alguse päev	14.02.2005	
(18) Registreeringu kehtivuse lõppemise päev	14.02.2010	
(28) Variantide arv	1	
(30) Prioriteediandmed	M20040140, 06.09.2004, FI	
(72) Autor	Rami Toivonen, Karjusaarenkatu 66, FI-15240 Lahti, FI Riikka Salokannel, Karjusaarenkatu 66, FI-15240 Lahti, FI	
(73) Omanik	Oy Sinebrychoff Ab, Sinebrychoffinaukio 1, FI-04250 Kerava, FI	
(74) Patendivolinik või ühine esindaja	Juta-Maris Uustalu	

(54) Nimetus **Pudel**

(55) Reproduktsoon

01058-01

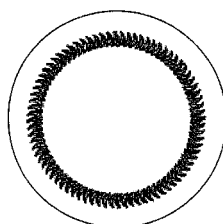
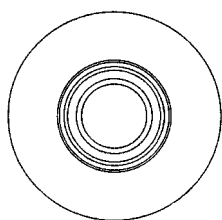
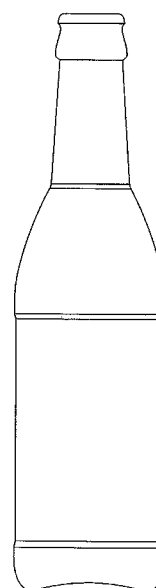
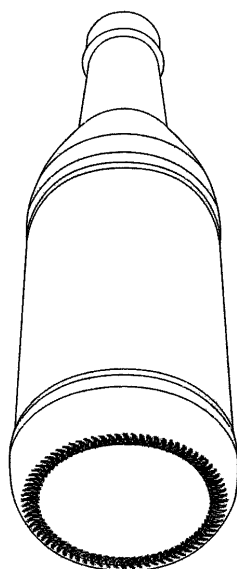
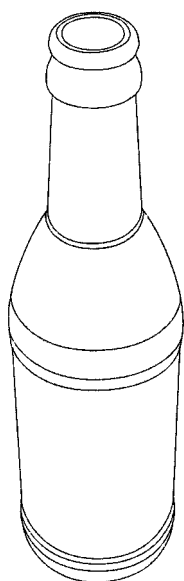

(11) Registreeringu number	<b>01059</b>	(51) Klass: <b>14-03</b>
(21) Taotluse number	D200500010	
(15) Registreerimise päev	16.05.2005	
(22) Esitamise päev	23.02.2005	
(24) Registreeringu kehtivuse alguse päev	23.02.2005	
(18) Registreeringu kehtivuse lõppemise päev	23.02.2010	
(28) Variantide arv	1	
(30) Prioriteediandmed	M20040135, 31.08.2004, FI	
(72) Autor	Tej Chauhan, 109 Beverley Drive, Edgware, Middlesex HA8 5NH, GB Tanja Fisher, 40B Strawberry Hill Road, Twickenham, Middlesex TW1 4PU, GB	
(73) Omanik	Nokia Corporation, Keilalahdentie 4, FIN-02150 Espoo, FI	
(74) Patendivolinik või ühine esindaja	Kaie Puur	

(54) Nimetus **Käsitelefon**

(55) Reproduktsoon

01059-01

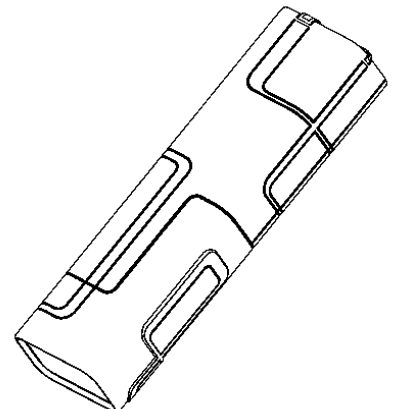
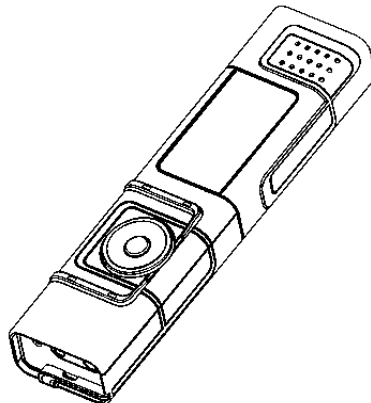
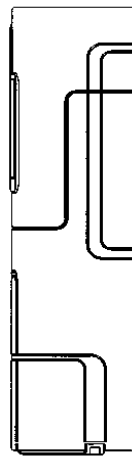
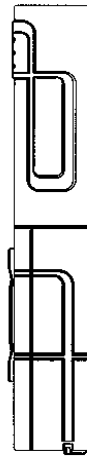
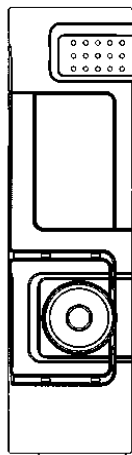
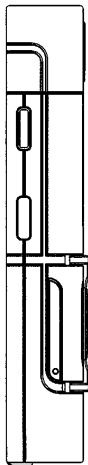
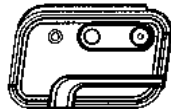

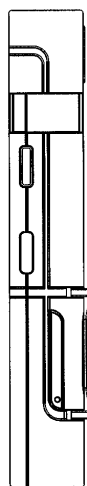
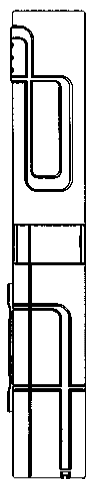
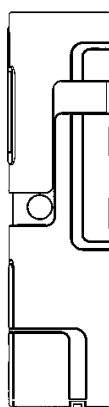
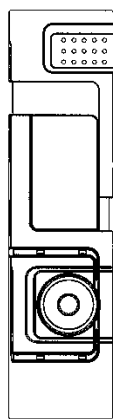
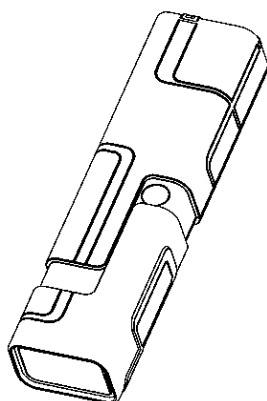
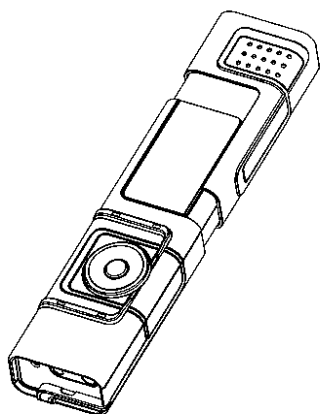

- (11) **Registreeringu number** **01060** (51) Klass: **02-02, 02-07, 14-03**
- (21) **Taotluse number** D200400071
- (15) **Registreerimise päev** 16.05.2005
- (22) **Esitamise päev** 09.06.2004
- (24) **Registreeringu kehtivuse alguse päev** 09.06.2004
- (18) **Registreeringu kehtivuse lõppemise päev** 09.06.2009
- (28) **Variantide arv** 1
- (72) **Autor** Veiko Paalma, Kadaka tee 113 A, 12915 Tallinn, EE  
Leino Vint, Kadaka tee 113 A, 12915 Tallinn, EE  
Sergei Babitšenko, Kadaka tee 113 A, 12915 Tallinn, EE
- (73) **Omanik** AS LASER DIAGNOSTIC INSTRUMENTS, Kadaka tee 113 A, 12915 Tallinn, EE
- (74) **Patendivolinik või ühine esindaja** Ott Moorlat

(54) **Nimetus** **Dekoratiivsete optiliste andmeside elementidega varustatud rõivas**

(55) **Reproduktsoon**

01060-01



- (11) **Registreeringu number** **01061** (51) Klass: **02-02, 02-07, 14-03**
- (21) **Taotluse number** D200400147
- (15) **Registreerimise päev** 16.05.2005
- (22) **Esitamise päev** 29.12.2004
- (24) **Registreeringu kehtivuse alguse päev** 29.12.2004
- (18) **Registreeringu kehtivuse lõppemise päev** 29.12.2009
- (28) **Variantide arv** 2
- (72) **Autor** Veiko Paalma, Kadaka tee 113 A, 12915 Tallinn, EE  
Leino Vint, Kadaka tee 113 A, 12915 Tallinn, EE  
Sergei Babitšenko, Kadaka tee 113 A, 12915 Tallinn, EE
- (73) **Omanik** AS Laser Diagnostic Instruments, Kadaka tee 113 A, 12915 Tallinn, EE
- (74) **Patendivolinik või ühine esindaja** Ott Moorlat
- (54) **Nimetus** **Dekoratiivsete optiliste andmeside elementidega varustatud rõivas**
- (55) **Reproduktsoon**

01061-01



01061-02

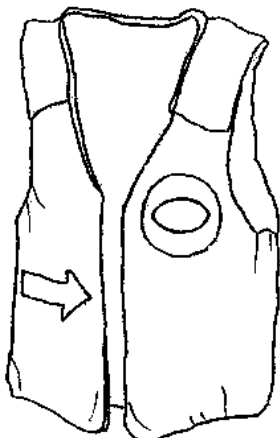

- (11) **Registreeringu number** **01062** (51) Klass: **02-02, 02-07, 14-03**
- (21) **Taotluse number** D200400148
- (15) **Registreerimise päev** 16.05.2005
- (22) **Esitamise päev** 29.12.2004
- (24) **Registreeringu kehtivuse alguse päev** 29.12.2004
- (18) **Registreeringu kehtivuse lõppemise päev** 29.12.2009
- (28) **Variantide arv** 2
- (72) **Autor** Veiko Paalma, Kadaka tee 113 A, 12915 Tallinn, EE  
Leino Vint, Kadaka tee 113 A, 12915 Tallinn, EE  
Sergei Babitšenko, Kadaka tee 113 A, 12915 Tallinn, EE
- (73) **Omanik** AS Laser Diagnostic Instruments, Kadaka tee 113 A, 12915 Tallinn, EE
- (74) **Patendivolinik või ühine esindaja** Ott Moorlat
- (54) **Nimetus** **Dekoratiivsete optiliste andmeside elementidega varustatud rõivas**
- (55) **Reproduktsoon**

01062-01



01062-02

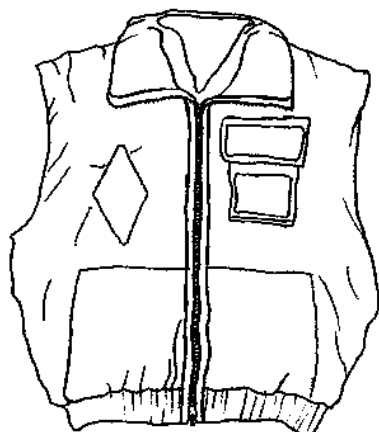



- (11) **Registreeringu number** **01063** (51) Klass: **02-02, 02-07, 14-03**
- (21) **Taotluse number** D200400149
- (15) **Registreerimise päev** 16.05.2005
- (22) **Esitamise päev** 29.12.2004
- (24) **Registreeringu kehtivuse alguse päev** 29.12.2004
- (18) **Registreeringu kehtivuse lõppemise päev** 29.12.2009
- (28) **Variantide arv** 2
- (72) **Autor** Veiko Paalma, Kadaka tee 113 A, 12915 Tallinn, EE  
Leino Vint, Kadaka tee 113 A, 12915 Tallinn, EE  
Sergei Babitšenko, Kadaka tee 113 A, 12915 Tallinn, EE
- (73) **Omanik** AS Laser Diagnostic Instruments, Kadaka tee 113 A, 12915 Tallinn, EE
- (74) **Patendivolinik või ühine esindaja** Ott Moorlat
- (54) **Nimetus** **Dekoratiivsete optiliste andmeside elementidega varustatud rõivas**
- (55) **Reproduktsoon**

01063-01



01063-02

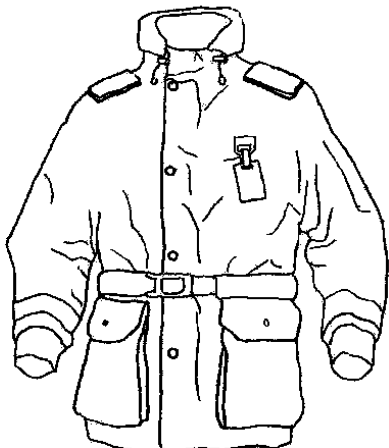

- (11) **Registreeringu number** **01064** (51) Klass: **09-03, 19-08**
- (21) **Taotluse number** D200500002
- (15) **Registreerimise päev** 16.05.2005
- (22) **Esitamise päev** 14.02.2005
- (24) **Registreeringu kehtivuse alguse päev** 14.02.2005
- (18) **Registreeringu kehtivuse lõppemise päev** 14.02.2010
- (28) **Variantide arv** 4
- (72) **Autor** Hanno Niinepuu, Sõõru 38, 13516 Tallinn, EE
- (73) **Omanik** AS Eesti Munatooted, Saha tee 18, Loo, 74201 Harju maakond, Jõelähtme vald, EE
- (74) **Patendivolinik või ühine esindaja** Lembit Kalev

(54) **Nimetus** **Pakendi pinnalaotus kujundusmotiiviga**

(55) **Reproduktsoon**

01064-01



01064-02



01064-03



01064-04



- (11) **Registreeringu number** **01065** (51) Klass: **19-08**
- (21) **Taotluse number** D200500004
- (15) **Registreerimise päev** 16.05.2005
- (22) **Esitamise päev** 15.02.2005
- (24) **Registreeringu kehtivuse alguse päev** 15.02.2005
- (18) **Registreeringu kehtivuse lõppemise päev** 15.02.2010
- (28) **Variantide arv** 2
- (72) **Autor** Sergei Melnik, Läänemere tee 3-197, 13913 Tallinn, EE
- (73) **Omanik** Sergei Melnik, Läänemere tee 3-197, 13913 Tallinn, EE
- (74) **Patendivolinik või ühine esindaja** Ott Moorlat
- (54) **Nimetus** **Reklaammaterjal**
- (55) **Reproduktsoon**

01065-01



01065-02



(11) **Registreeringu number** **01066**

(51) Klass: **14-03, 14-02**

(21) **Taotluse number** D200500011

(15) **Registreerimise päev** 16.05.2005

(22) **Esitamise päev** 02.03.2005

(24) **Registreeringu kehtivuse alguse päev** 02.03.2005

(18) **Registreeringu kehtivuse lõppemise päev** 02.03.2010

(28) **Variantide arv** 1

(30) **Prioriteediandmed** M20040137, 02.09.2004, FI

(72) **Autor** Jean-Marc Hering, Honkatie 4 B, 24160 Salo, FI

(73) **Omanik** Nokia Corporation, Keilalahdentie 4, FIN-02150 Espoo, FI

(74) **Patendivolinik või ühine esindaja** Kaie Puur

(54) **Nimetus** **Kommunikaator**

(55) **Reproduktsoon**

01066-01

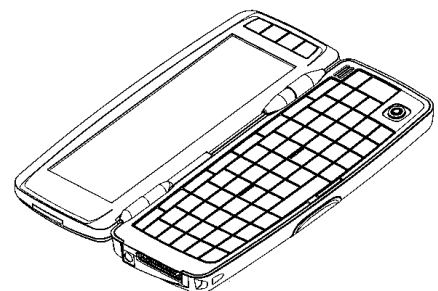
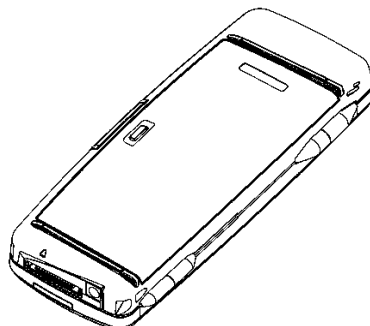
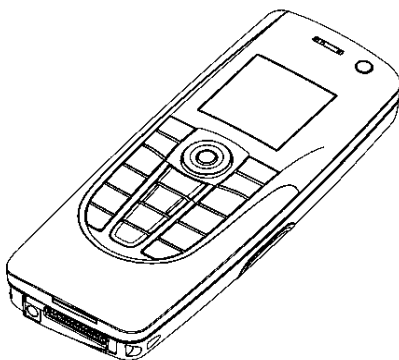
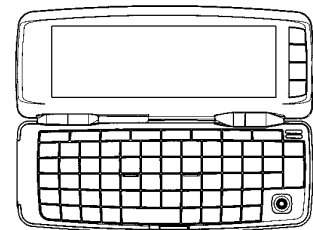
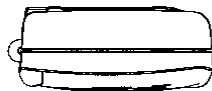
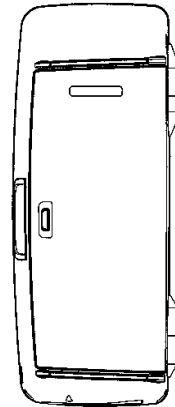
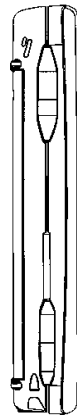
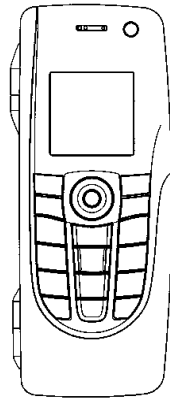
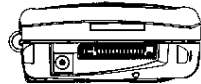

(11) Registreeringu number	<b>01067</b>	(51) Klass: <b>14-02, 14-03</b>
(21) Taotluse number	D200500012	
(15) Registreerimise päev	16.05.2005	
(22) Esitamise päev	02.03.2005	
(24) Registreeringu kehtivuse alguse päev	02.03.2005	
(18) Registreeringu kehtivuse lõppemise päev	02.03.2010	
(28) Variantide arv	1	
(30) Prioriteediandmed	M20040137, 02.09.2004, FI	
(72) Autor	Jean-Marc Hering, Honkatie 4 B, 24160 Salo, FI	
(73) Omanik	Nokia Corporation, Keilalahdentie 4, FIN-02150 Espoo, FI	
(74) Patendivolinik või ühine esindaja	Kaie Puur	

(54) Nimetus **Kommunikaatori klaviatuuri klahvide paigutus / klaviatuur**

(55) Reproduktsoon

01067-01

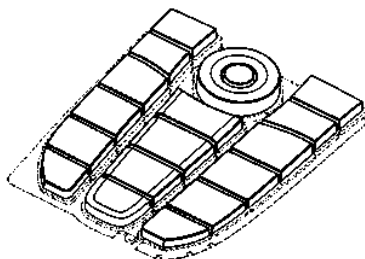
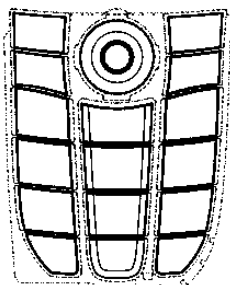
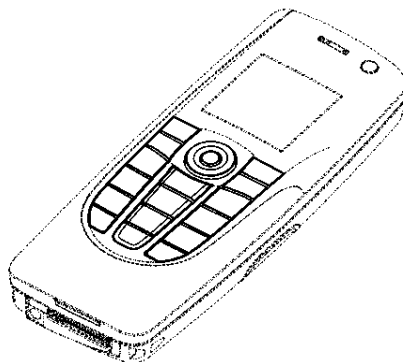
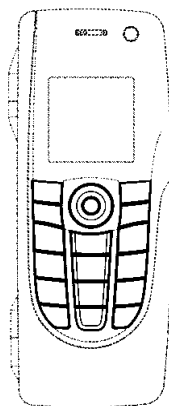

(11) Registreeringu number	<b>01068</b>	(51) Klass: <b>14-02, 14-03</b>
(21) Taotluse number	D200500013	
(15) Registreerimise päev	16.05.2005	
(22) Esitamise päev	02.03.2005	
(24) Registreeringu kehtivuse alguse päev	02.03.2005	
(18) Registreeringu kehtivuse lõppemise päev	02.03.2010	
(28) Variantide arv	1	
(30) Prioriteediandmed	M20040137, 02.09.2004, FI	
(72) Autor	Jean-Marc Hering, Honkatie 4 B, 24160 Salo, FI	
(73) Omanik	Nokia Corporation, Keilalahdentie 4, FIN-02150 Espoo, FI	
(74) Patendivolinik või ühine esindaja	Kaie Puur	

(54) Nimetus **Kommunikaatori esipaneel**

(55) Reproduktsoon

01068-01

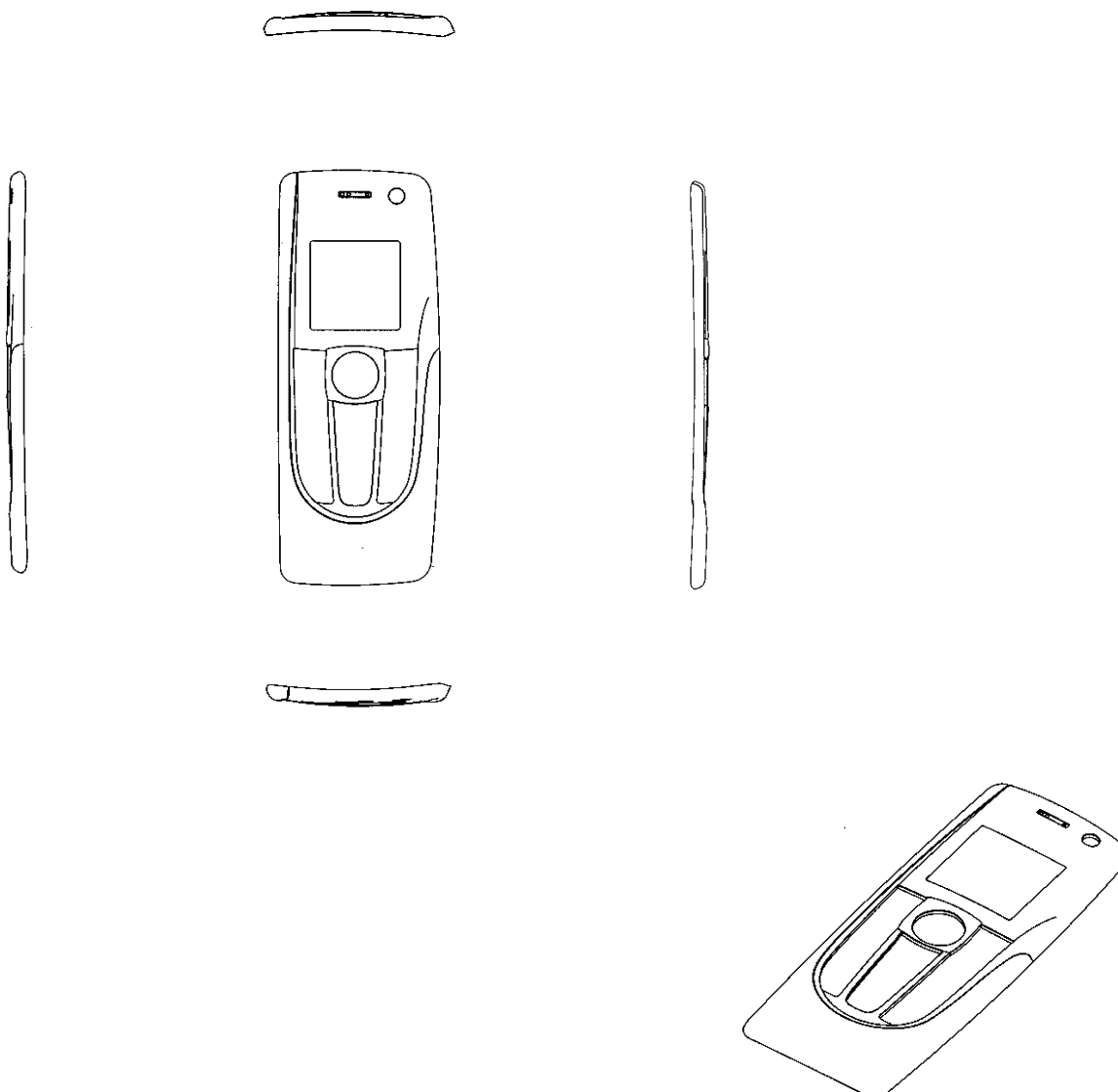

(11) Registreeringu number	<b>01069</b>	(51) Klass: <b>23-04</b>
(21) Taotluse number	D200500014	
(15) Registreerimise päev	16.05.2005	
(22) Esitamise päev	07.03.2005	
(24) Registreeringu kehtivuse alguse päev	07.03.2005	
(18) Registreeringu kehtivuse lõppemise päev	07.03.2010	
(28) Variantide arv	2	
(30) Prioriteediandmed	M20040142, 08.09.2004, FI	
(72) Autor	Eero Rislakki, Kaptensgatan 18, SE-252 70 Råå, SE	
(73) Omanik	Fläkt Woods AB, Fläktgatan 1, SE-55184 Jönköping, SE	
(74) Patendivolinik või ühine esindaja	Jaak Ostrat	

(54) Nimetus **Õhuvõtuseade**

(55) Reproduktsoon

01069-01

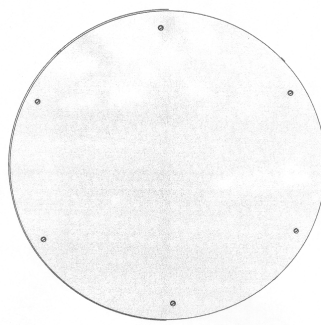
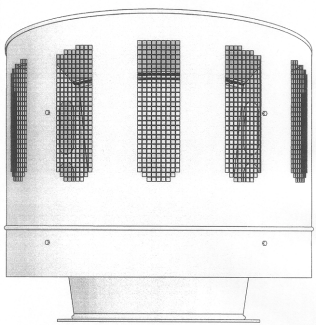
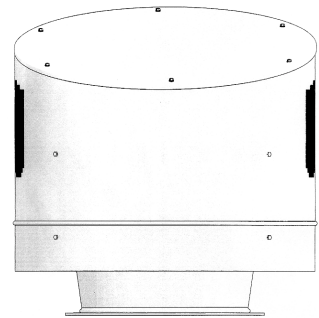
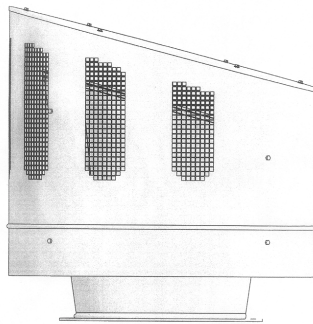
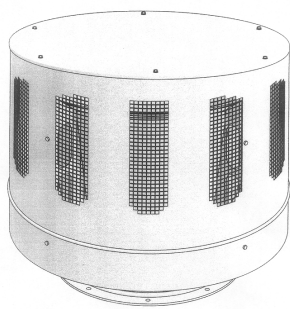

01069-02

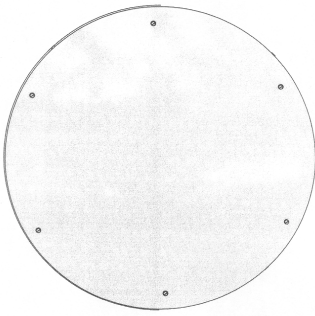
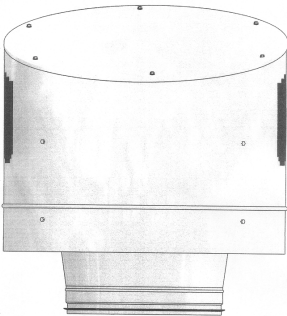
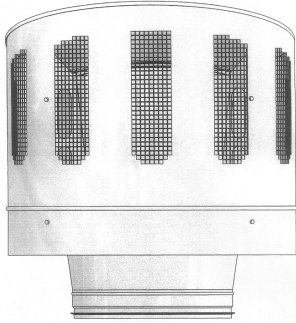
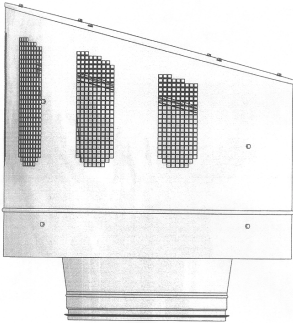
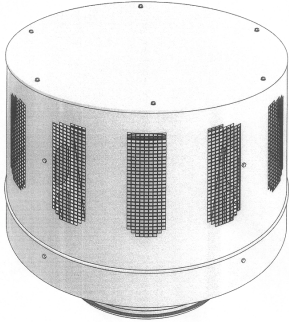



## **II. RAHVUSVAHELISELT REGISTREERITUD TÖÖSTUSDISAINILAHENDUSED**

Avaldatakse "Tööstusdisaini kaitse seaduse" § 87<sup>4</sup> lõike37 alusel.

(11) <b>Rahvusvah reg nr</b>	<b>DM/065284</b>	(51) Klass: <b>07-06</b>
(21) <b>Rahvusvah reg jrk</b>	H200400079	
(15) <b>Registreeringu päev</b>	01.04.2004	
(22) <b>Esitamise päev</b>	01.04.2004	
(28) <b>Variantide arv</b>	1	
(30) <b>Prioriteediandmed</b>	29/191,248, 03.10.2003, US	
(72) <b>Autor</b>	Thomas Overthun, 82, Valley St., San Francisco CA 94110, US Annetta Papadopoulos, 1155 Lincoln Ave, Palo Alto CA 94301, US Larry Cheng, 812 Fountain Park Lane, Mountain View CA 94043, US ZYLISS AG, Schachenweg 24, CH-3250 Lyss, CH	
(73) <b>Omanik</b>		
<b>WIPO Rahvusvah Tööstusdisainilahenduste</b>		
<b>Bülletääni nr, kus registreering on avaldatud</b>	2004/09	

(54) **Nimetus** **Corn holder**

(55) **Reproduksioon**

DM/065284-01

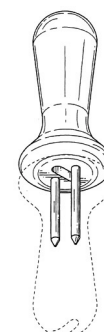
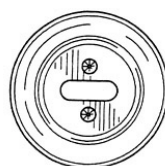
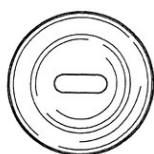
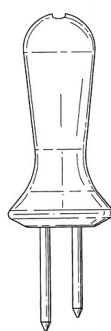
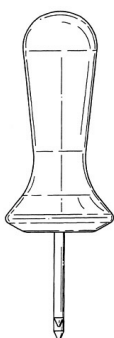
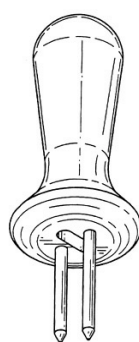
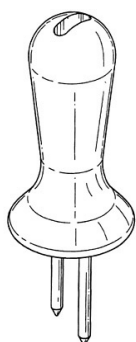

(11) <b>Rahvusvah reg nr</b>	<b>DM/065294</b>	(51) Klass: <b>10-02</b>
(21) <b>Rahvusvah reg jrk</b>	H200400001	
(15) <b>Registreeringu päev</b>	06.04.2004	
(22) <b>Esitamise päev</b>	06.04.2004	
(28) <b>Variantide arv</b>	2	
(72) <b>Autor</b>	Nicole DUPONT, Dupont Design, Chemin des Raclerets 26, 1284 Chancy, CH Rossana BOFFI, Swatchlab, Via Archimede 6, 20129 Milano, IT SWATCH AG (SWATCH SA) (SWATCH LTD.), 94, Rue Jakob Stämpfli, CH-2502 BIENNE, CH	
(73) <b>Omanik</b>		
<b>WIPO Rahvusvah Tööstusdisainilahenduste Bülletääni nr, kus registreering on avaldatud</b>	2004/07	

(54) **Nimetus** **Wristwatches**

(55) **Reproduktsoon**

DM/065294-01



DM/065294-02



(11) <b>Rahvusvah reg nr</b>	<b>DM/065297</b>	(51) <b>Klass: 10-02</b>
(21) <b>Rahvusvah reg jrk</b>	H200400004	
(15) <b>Registreeringu päev</b>	13.04.2004	
(22) <b>Esitamise päev</b>	13.04.2004	
(28) <b>Variantide arv</b>	1	
(72) <b>Autor</b>	Andrea ARRIGONI, Swatchlab, Via Archimede 6, 20129 Milano, IT	
(73) <b>Omanik</b>	SWATCH AG (SWATCH SA) (SWATCH LTD.), 94, Rue Jakob Stämpfli, CH-2502 BIENNE, CH	

**WIPO Rahvusvah Tööstusdisainilahenduste**  
**Bülletääni nr, kus registreering on avaldatud** 2004/07

(54) **Nimetus** **Wristwatch**

(55) **Reproduksioon**

DM/065297-01



(11) <b>Rahvusvah reg nr</b>	<b>DM/065299</b>	(51) Klass: <b>10-02</b>
(21) <b>Rahvusvah reg jrk</b>	H200400005	
(15) <b>Registreeringu päev</b>	13.04.2004	
(22) <b>Esitamise päev</b>	13.04.2004	
(28) <b>Variantide arv</b>	1	
(72) <b>Autor</b>	Malcolm DRAGOTTA, Swatchlab, Via Archimede 6, 20129 IT, IT	
(73) <b>Omanik</b>	SWATCH AG (SWATCH SA) (SWATCH LTD.), 94, Rue Jakob Stämpfli, CH-2502 BIENNE, CH	
<b>WIPO Rahvusvah Tööstusdisainilahenduste Bülletääni nr, kus registreering on avaldatud</b>	2004/07	

(54) **Nimetus** **Wristwatch**

(55) **Reproduktsoon**

DM/065299-01



(11) <b>Rahvusvah reg nr</b>	<b>DM/065313</b>	(51) <b>Klass: 10-02</b>
(21) <b>Rahvusvah reg jrk</b>	H200400007	
(15) <b>Registreeringu päev</b>	27.04.2004	
(22) <b>Esitamise päev</b>	27.04.2004	
(28) <b>Variantide arv</b>	1	
(72) <b>Autor</b>	Paula Schulmann, SWATCHLAB, Via Archimede 6, 20129 MILANO, IT	
(73) <b>Omanik</b>	SWATCH AG (SWATCH SA) (SWATCH LTD.), 94, Rue Jakob Stämpfli, CH-2502 BIENNE, CH	
<b>WIPO Rahvusvah Tööstusdisainilahenduste Bülletääni nr, kus registreering on avaldatud</b>	2004/07	

(54) **Nimetus** **Wristwatch**

(55) **Reproduktsoon**

DM/065313-01



(11) <b>Rahvusvah reg nr</b>	<b>DM/065314</b>	(51) Klass: <b>10-02</b>
(21) <b>Rahvusvah reg jrk</b>	H200400008	
(15) <b>Registreeringu päev</b>	27.04.2004	
(22) <b>Esitamise päev</b>	27.04.2004	
(28) <b>Variantide arv</b>	1	
(72) <b>Autor</b>	Ruben Corunfeld, Soci�t� Eugevan, 6, rue du Port, 83990 ST-TROPEZ, FR	
(73) <b>Omanik</b>	SWATCH AG (SWATCH SA) (SWATCH LTD.), 94, Rue Jakob St�mpfli, CH-2502 BIENNE, CH	

**WIPO Rahvusvah T ostusdisainilahenduste B llet ani nr, kus registreering on avaldatud** 2004/07

(54) **Nimetus** **Wristwatch**

(55) **Reproduksioon**

DM/065314-01



(11) <b>Rahvusvah reg nr</b>	<b>DM/065344</b>	(51) Klass: <b>10-07</b>
(21) <b>Rahvusvah reg jrk</b>	H200400009	
(15) <b>Registreeringu päev</b>	29.04.2004	
(22) <b>Esitamise päev</b>	29.04.2004	
(28) <b>Variantide arv</b>	1	
(72) <b>Autor</b>	Jerry Simonis, Jolimont 1, 2400 Le Locle, CH	
(73) <b>Omanik</b>	THE SWATCH GROUP MANAGEMENT SERVICES AG (THE SWATCH GROUP MANAGEMENT SERVICES SA), (THE SWATCH GROUP MANAGEMENT SERVICES LTD.), Seevorstadt 6, CH-2502 BIENNE, CH	

**WIPO Rahvusvah Tööstusdisainilahenduste  
Bülletääni nr, kus registreering on avaldatud** 2004/07

(54) **Nimetus** **Watch case**

(55) **Reproduksioon**

DM/065344-01





(11) <b>Rahvusvah reg nr</b>	<b>DM/065347</b>	(51) Klass: <b>10-02</b>
(21) <b>Rahvusvah reg jrk</b>	H200400010	
(15) <b>Registreeringu päev</b>	29.04.2004	
(22) <b>Esitamise päev</b>	29.04.2004	
(28) <b>Variantide arv</b>	1	
(72) <b>Autor</b>	Adelina BISSOLO, SWATCHLAB, Via Archimede 6, 20129 MILANO, IT	
(73) <b>Omanik</b>	SWATCH AG (SWATCH SA) (SWATCH LTD.), 94, Rue Jakob Stämpfli, CH-2502 BIENNE, CH	
<b>WIPO Rahvusvah Tööstusdisainilahenduste Bülletääni nr, kus registreering on avaldatud</b>	2004/07	

(54) **Nimetus** **Wristwatch**

(55) **Reproduktsoon**

DM/065347-01



(11) <b>Rahvusvah reg nr</b>	<b>DM/065360</b>	(51) Klass: <b>11-02</b>
(21) <b>Rahvusvah reg jrk</b>	H200400012	
(15) <b>Registreeringu päev</b>	06.04.2004	
(22) <b>Esitamise päev</b>	06.04.2004	
(28) <b>Variantide arv</b>	1	
(72) <b>Autor</b>	Arlette EMCH, Rue des Mornets 31, CH-2520 La Neuveville, CH	
(73) <b>Omanik</b>	OMEGA SA (OMEGA AG) (OMEGA LTD.), Jakob-Stämpfli-Strasse 96, CH-2502 Biel/Bienne, CH	

**WIPO Rahvusvah Tööstusdisainilahenduste**  
**Bülletääni nr, kus registreering on avaldatud** 2004/07

(54) **Nimetus** **Jewel**

(55) **Reproduksioon**

DM/065360-01



(11) <b>Rahvusvah reg nr</b>	<b>DM/065362</b>	(51) Klass: <b>10-02</b>
(21) <b>Rahvusvah reg jrk</b>	H200400014	
(15) <b>Registreeringu päev</b>	12.05.2004	
(22) <b>Esitamise päev</b>	12.05.2004	
(28) <b>Variantide arv</b>	1	
(72) <b>Autor</b>	Nicole Dupont, Dupont Design SA, Rte des Jeunes 33, CH-1227 CAROUGE, CH	
(73) <b>Omanik</b>	SWATCH AG (SWATCH SA) (SWATCH LTD.), 94, Rue Jakob Stämpfli, CH-2502 BIENNE, CH	

**WIPO Rahvusvah Tööstusdisainilahenduste  
Bülletääni nr, kus registreering on avaldatud** 2004/07

(54) **Nimetus** **Wrist-watch**

(55) **Reproduksioon**

DM/065362-01



(11) <b>Rahvusvah reg nr</b>	<b>DM/065366</b>	(51) Klass: <b>10-02</b>
(21) <b>Rahvusvah reg jrk</b>	H200400017	
(15) <b>Registreeringu päev</b>	05.05.2004	
(22) <b>Esitamise päev</b>	05.05.2004	
(28) <b>Variantide arv</b>	1	
(72) <b>Autor</b>	Fabio BUCCIARDINI, SWATCHLAB, Via Archimede 6, I-20129 MILANO, IT	
(73) <b>Omanik</b>	SWATCH AG (SWATCH SA) (SWATCH LTD.), 94, Rue Jakob Stämpfli, CH-2502 BIENNE, CH	
<b>WIPO Rahvusvah Tööstusdisainilahenduste Bülletääni nr, kus registreering on avaldatud</b>	2004/07	

(54) **Nimetus** **Wristwatch**

(55) **Reproduksioon**

DM/065366-01



(11) <b>Rahvusvah reg nr</b>	<b>DM/065368</b>	(51) Klass: <b>10-02</b>
(21) <b>Rahvusvah reg jrk</b>	H200400019	
(15) <b>Registreeringu päev</b>	06.04.2004	
(22) <b>Esitamise päev</b>	06.04.2004	
(28) <b>Variantide arv</b>	2	
(72) <b>Autor</b>	Nicole DUPONT, Dupont Design, Chemin des Raclerets 26, 1284 Chancy, CH	
(73) <b>Omanik</b>	SWATCH AG (SWATCH SA) (SWATCH LTD.), 94, Rue Jakob Stämpfli, CH-2502 BIENNE, CH	
<b>WIPO Rahvusvah Tööstusdisainilahenduste Bülletääni nr, kus registreering on avaldatud</b>	2004/07	

(54) **Nimetus** **Wristwatches**

(55) **Reproduktsoon**

DM/065368-01



DM/065368-02



(11) <b>Rahvusvah reg nr</b>	<b>DM/065369</b>	(51) Klass: <b>10-02</b>
(21) <b>Rahvusvah reg jrk</b>	H200400020	
(15) <b>Registreeringu päev</b>	05.05.2004	
(22) <b>Esitamise päev</b>	05.05.2004	
(28) <b>Variantide arv</b>	1	
(72) <b>Autor</b>	Malcolm DRAGOTTA, Swatchlab, Via Archimede 6, 20129 IT, IT	
(73) <b>Omanik</b>	SWATCH AG (SWATCH SA) (SWATCH LTD.), 94, Rue Jakob Stämpfli, CH-2502 BIENNE, CH	
<b>WIPO Rahvusvah Tööstusdisainilahenduste Bülletääni nr, kus registreering on avaldatud</b>	2004/07	

(54) **Nimetus** **Wristwatch**

(55) **Reproduktsoon**

DM/065369-01



(11) <b>Rahvusvah reg nr</b>	<b>DM/065370</b>	(51) Klass: <b>10-02</b>
(21) <b>Rahvusvah reg jrk</b>	H200400021	
(15) <b>Registreeringu päev</b>	12.05.2004	
(22) <b>Esitamise päev</b>	12.05.2004	
(28) <b>Variantide arv</b>	1	
(72) <b>Autor</b>	Davide MARIANI, SWATCHLAB, Via Archimede 6, I-20129 MILANO, IT	
(73) <b>Omanik</b>	SWATCH AG (SWATCH SA) (SWATCH LTD.), 94, Rue Jakob Stämpfli, CH-2502 BIENNE, CH	
<b>WIPO Rahvusvah Tööstusdisainilahenduste Bülletääni nr, kus registreering on avaldatud</b>	2004/07	

(54) **Nimetus** **Wristwatch**

(55) **Reproduksioon**

DM/065370-01



(11) <b>Rahvusvah reg nr</b>	<b>DM/065371</b>	(51) Klass: <b>10-02</b>
(21) <b>Rahvusvah reg jrk</b>	H200400022	
(15) <b>Registreeringu päev</b>	12.05.2004	
(22) <b>Esitamise päev</b>	12.05.2004	
(28) <b>Variantide arv</b>	1	
(72) <b>Autor</b>	Nicz RIPZ, A New Day GmbH, Laurenz-Sond. Str. 3b, CH-9436 Balgach, CH	
(73) <b>Omanik</b>	SWATCH AG (SWATCH SA) (SWATCH LTD.), 94, Rue Jakob Stämpfli, CH-2502 BIENNE, CH	
<b>WIPO Rahvusvah Tööstusdisainilahenduste Bülletääni nr, kus registreering on avaldatud</b>	2004/07	

(54) **Nimetus** **Wristwatch**

(55) **Reproduksioon**

DM/065371-01





(11) <b>Rahvusvah reg nr</b>	<b>DM/065380</b>	(51) Klass: <b>10-07</b>
(21) <b>Rahvusvah reg jrk</b>	H200400023	
(15) <b>Registreeringu päev</b>	13.05.2004	
(22) <b>Esitamise päev</b>	13.05.2004	
(28) <b>Variantide arv</b>	1	
(72) <b>Autor</b>	Jaques MÜLLER, CDNP, A Div. of the Swatch Group Management Services Ltd., Schützengasse 30, CH-2540 GRENCHEN, CH	
(73) <b>Omanik</b>	SWATCH AG (SWATCH SA) (SWATCH LTD.), 94, Rue Jakob Stämpfli, CH-2502 BIENNE, CH	
<b>WIPO Rahvusvah Tööstusdisainilahenduste Bülettääni nr, kus registreering on avaldatud</b>	2004/07	

- (54) **Nimetus** **Additional case for a chronograph wristwatch**
- (55) **Reproduksioon**

DM/065380-01

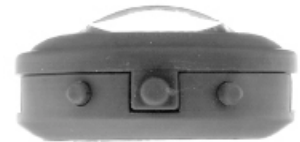

- (11) **Rahvusvah reg nr** DM/065392 (51) Klass: **10-07**
- (21) **Rahvusvah reg jrk** H200400025
- (15) **Registreeringu päev** 18.05.2004
- (22) **Esitamise päev** 18.05.2004
- (28) **Variantide arv** 1
- (72) **Autor** Nicole DUPONT, DUPONT DESIGN SA, Route des Jeunes 33,  
CH-1227 Carouge, CH
- (73) **Omanik** SWATCH AG (SWATCH SA) (SWATCH LTD.), 94, Rue Jakob Stämpfli,  
CH-2502 BIENNE, CH
- WIPO Rahvusvah Tööstusdisainilahenduste**  
**Bülletääni nr, kus registreering on avaldatud** 2004/07

(54) **Nimetus** Watch strap

(55) **Reproduktsoon**

DM/065392-01



(11) <b>Rahvusvah reg nr</b>	<b>DM/065393</b>	(51) Klass: <b>10-02</b>
(21) <b>Rahvusvah reg jrk</b>	H200400026	
(15) <b>Registreeringu päev</b>	18.05.2004	
(22) <b>Esitamise päev</b>	18.05.2004	
(28) <b>Variantide arv</b>	1	
(72) <b>Autor</b>	Danilo SALA, SWATCHLAB, Via Archimede 6, I-20129 MILANO, IT	
(73) <b>Omanik</b>	SWATCH AG (SWATCH SA) (SWATCH LTD.), 94, Rue Jakob Stämpfli, CH-2502 BIENNE, CH	
<b>WIPO Rahvusvah Tööstusdisainilahenduste Bülletääni nr, kus registreering on avaldatud</b>	2004/07	

(54) **Nimetus** **Wristwatch**

(55) **Reproduktsoon**

DM/065393-01



(11) <b>Rahvusvah reg nr</b>	<b>DM/065394</b>	(51) Klass: <b>10-02</b>
(21) <b>Rahvusvah reg jrk</b>	H200400027	
(15) <b>Registreeringu päev</b>	18.05.2004	
(22) <b>Esitamise päev</b>	18.05.2004	
(28) <b>Variantide arv</b>	1	
(72) <b>Autor</b>	Nicole DUPONT, DUPONT DESIGN SA, Route des Jeunes 33, CH-1227 Carouge, CH	
(73) <b>Omanik</b>	SWATCH AG (SWATCH SA) (SWATCH LTD.), 94, Rue Jakob Stämpfli, CH-2502 BIENNE, CH	
<b>WIPO Rahvusvah Tööstusdisainilahenduste Bülletääni nr, kus registreering on avaldatud</b>	2004/07	

(54) **Nimetus** **Wristwatch**

(55) **Reproduksioon**

DM/065394-01



(11) **Rahvusvah reg nr**

DM/065459

(51) Klass: **11-01**(21) **Rahvusvah reg jrk**

H200400029

(15) **Registreeringu päev**

09.06.2004

(22) **Esitamise päev**

09.06.2004

(28) **Komplektide arv**

1

(23) **Prioriteediandmed**

15.04.2004, CH

(72) **Autor***Autori andmeid ei avalikustata*(73) **Omanik**LÉON HATOT SA (LÉON HATOT AG) (LÉON HATOT LTD.),  
Fauborg de l'Hôpital 3, CH-2000 Neuchâtel, CH**WIPO Rahvusvah Tööstusdisainilahenduste  
Bülletääni nr, kus registreering on avaldatud**

2004/07

(54) **Nimetus**

Jewels

(55) **Reproduktsoon**

DM/065459-01



(11) <b>Rahvusvah reg nr</b>	<b>DM/065465</b>	(51) Klass: <b>10-02</b>
(21) <b>Rahvusvah reg jrk</b>	H200400031	
(15) <b>Registreeringu päev</b>	17.06.2004	
(22) <b>Esitamise päev</b>	17.06.2004	
(28) <b>Variantide arv</b>	2	
(72) <b>Autor</b>	1.1. Nicole DUPONT, Dupont Design SA, Rte des Jeunes 33, CH-1127 Carouge/Genève, CH 2.1. Paula Shulmann, SWATCHLAB, Via Archimede 6, IT-20129 MILANO, IT	
(73) <b>Omanik</b>	SWATCH AG (SWATCH SA) (SWATCHLTD.), 94, Rue Jakob Stämpfli, CH-2502 BIENNE, CH	
<b>WIPO Rahvusvah Tööstusdisainilahenduste Bülletääni nr, kus registreering on avaldatud</b>	2004/07	

(54) **Nimetus** **Wristwatches**

(55) **Reproduktsoon**

DM/065465-01



DM/065465-02



(11) <b>Rahvusvah reg nr</b>	<b>DM/065467</b>	(51) Klass: <b>10-02</b>
(21) <b>Rahvusvah reg jrk</b>	H200400032	
(15) <b>Registreeringu päev</b>	17.06.2004	
(22) <b>Esitamise päev</b>	17.06.2004	
(28) <b>Variantide arv</b>	1	
(72) <b>Autor</b>	Nicole DUPONT, Dupont Design SA, Rte des Jeunes 33, CH-1127 Carouge/Genève, CH	
(73) <b>Omanik</b>	SWATCH AG (SWATCH SA) (SWATCH LTD.), 94, Rue Jakob Stämpfli, CH-2502 BIENNE, CH	

**WIPO Rahvusvah Tööstusdisainilahenduste  
Bülletääni nr, kus registreering on avaldatud** 2004/07

(54) **Nimetus** **Wristwatch**

(55) **Reproduksioon**

DM/065467-01



(11) <b>Rahvusvah reg nr</b>	<b>DM/065468</b>	(51) <b>Klass: 10-07</b>
(21) <b>Rahvusvah reg jrk</b>	H200400033	
(15) <b>Registreeringu päev</b>	17.06.2004	
(22) <b>Esitamise päev</b>	17.06.2004	
(28) <b>Variantide arv</b>	1	
(72) <b>Autor</b>	Rossana BOFFI, Swatchlab, Via Archimede 6, 20129 Milano, IT	
(73) <b>Omanik</b>	SWATCH AG (SWATCH SA) (SWATCH LTD.), 94, Rue Jakob Stämpfli, CH-2502 BIENNE, CH	

**WIPO Rahvusvah Tööstusdisainilahenduste**  
**Bülletääni nr, kus registreering on avaldatud** 2004/07

(54) **Nimetus** **Watch strap**

(55) **Reproduktsoon**

DM/065468-01

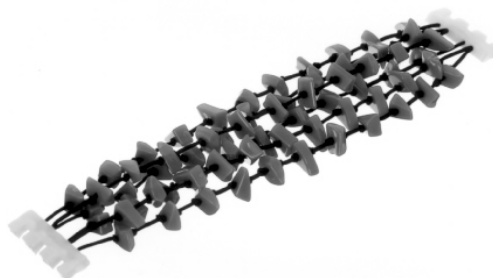



(11) <b>Rahvusvah reg nr</b>	<b>DM/065473</b>	(51) Klass: <b>10-02</b>
(21) <b>Rahvusvah reg jrk</b>	H200400036	
(15) <b>Registreeringu päev</b>	18.06.2004	
(22) <b>Esitamise päev</b>	18.06.2004	
(28) <b>Variantide arv</b>	1	
(72) <b>Autor</b>	Davide MARIANI, SWATCHLAB, Via Archimede 6, IT-20129 Milano, IT	
(73) <b>Omanik</b>	SWATCH AG (SWATCH SA) (SWATCH LTD.), 94, Rue Jakob Stämpfli, CH-2502 BIENNE, CH	

**WIPO Rahvusvah Tööstusdisainilahenduste  
Bülletääni nr, kus registreering on avaldatud** 2004/07

(54) **Nimetus** **Wristwatch**

(55) **Reproduksioon**

DM/065473-01



(11) <b>Rahvusvah reg nr</b>	<b>DM/065474</b>	(51) Klass: <b>10-02</b>
(21) <b>Rahvusvah reg jrk</b>	H200400037	
(15) <b>Registreeringu päev</b>	18.06.2004	
(22) <b>Esitamise päev</b>	18.06.2004	
(28) <b>Variantide arv</b>	1	
(72) <b>Autor</b>	Malcolm DRAGOTTA, SWATCHLAB, Via Archimede 6, IT-20129 Milano, IT	
(73) <b>Omanik</b>	SWATCH AG (SWATCH SA) (SWATCH LTD.), 94, Rue Jakob Stämpfli, CH-2502 BIENNE, CH	
<b>WIPO Rahvusvah Tööstusdisainilahenduste Bülletääni nr, kus registreering on avaldatud</b>	2004/07	

(54) **Nimetus** **Wristwatch**

(55) **Reproduksioon**

DM/065474-01



(11) <b>Rahvusvah reg nr</b>	<b>DM/065475</b>	(51) Klass: <b>10-02</b>
(21) <b>Rahvusvah reg jrk</b>	H200400038	
(15) <b>Registreeringu päev</b>	18.06.2004	
(22) <b>Esitamise päev</b>	18.06.2004	
(28) <b>Variantide arv</b>	1	
(72) <b>Autor</b>	Walter GARRO, SWATCHLAB, Via Archimede 6, IT-20129 MILANO, IT	
(73) <b>Omanik</b>	SWATCH AG (SWATCH SA) (SWATCH LTD.), 94, Rue Jakob Stämpfli, CH-2502 BIENNE, CH	
<b>WIPO Rahvusvah Tööstusdisainilahenduste Bülletääni nr, kus registreering on avaldatud</b>	2004/07	

(54) **Nimetus** **Wristwatch**

(55) **Reproduksioon**

DM/065475-01



(11) <b>Rahvusvah reg nr</b>	<b>DM/065480</b>	(51) <b>Klass: 10-02</b>
(21) <b>Rahvusvah reg jrk</b>	H200400039	
(15) <b>Registreeringu päev</b>	17.06.2004	
(22) <b>Esitamise päev</b>	17.06.2004	
(28) <b>Variantide arv</b>	1	
(72) <b>Autor</b>	Monachon Jean-Claude, La Biche, CH-2054 Les Vieux-Près, CH	
(73) <b>Omanik</b>	OMEGA SA (OMEGA AG) (OMEGA LTD.), Jakob-Stämpfli-Strasse 96, CH-2502 Biel/Bienne, CH	

**WIPO Rahvusvah Tööstusdisainilahenduste  
Bülletääni nr, kus registreering on avaldatud** 2004/07

(54) **Nimetus** **Wristwatch**

(55) **Reproduksioon**

DM/065480-01



(11) <b>Rahvusvah reg nr</b>	<b>DM/065494</b>	(51) Klass: <b>10-02</b>
(21) <b>Rahvusvah reg jrk</b>	H200400040	
(15) <b>Registreeringu päev</b>	18.06.2004	
(22) <b>Esitamise päev</b>	18.06.2004	
(28) <b>Variantide arv</b>	1	
(72) <b>Autor</b>	Paula Schulmann, SWATCHLAB, Via Archimede 6, 20129 MILANO, IT	
(73) <b>Omanik</b>	SWATCH AG (SWATCH SA) (SWATCH LTD.), 94, Rue Jakob Stämpfli, CH-2502 BIENNE, CH	
<b>WIPO Rahvusvah Tööstusdisainilahenduste Bülletääni nr, kus registreering on avaldatud</b>	2004/07	

(54) **Nimetus** **Wristwatch**

(55) **Reproduktsoon**

DM/065494-01



(11) <b>Rahvusvah reg nr</b>	<b>DM/065499</b>	(51) Klass: <b>10-02</b>
(21) <b>Rahvusvah reg jrk</b>	H200400042	
(15) <b>Registreeringu päev</b>	18.06.2004	
(22) <b>Esitamise päev</b>	18.06.2004	
(28) <b>Variantide arv</b>	1	
(72) <b>Autor</b>	Walter GARRO, SWATCHLAB, Via Archimede 6, IT-20129 MILANO, IT	
(73) <b>Omanik</b>	SWATCH AG (SWATCH SA) (SWATCH LTD.), 94, Rue Jakob Stämpfli, CH-2502 BIENNE, CH	
<b>WIPO Rahvusvah Tööstusdisainilahenduste Bülletääni nr, kus registreering on avaldatud</b>	2004/07	

(54) **Nimetus** **Wristwatch**

(55) **Reproduksioon**

DM/065499-01



(11) <b>Rahvusvah reg nr</b>	<b>DM/065501</b>	(51) Klass: <b>10-07</b>
(21) <b>Rahvusvah reg jrk</b>	H200400044	
(15) <b>Registreeringu päev</b>	18.06.2004	
(22) <b>Esitamise päev</b>	18.06.2004	
(28) <b>Variantide arv</b>	1	
(72) <b>Autor</b>	Malcolm DRAGOTTA, SWATCHLAB, Via Archimede 6, IT-20129 Milano, IT	
(73) <b>Omanik</b>	SWATCH AG (SWATCH SA) (SWATCH LTD.), 94, Rue Jakob Stämpfli, CH-2502 BIENNE, CH	

**WIPO Rahvusvah Tööstusdisainilahenduste  
Bülletääni nr, kus registreering on avaldatud** 2004/07

(54) **Nimetus** **Watch strap**

(55) **Reproduktsoon**

DM/065501-01



(11) <b>Rahvusvah reg nr</b>	<b>DM/065503</b>	(51) <b>Klass: 10-02</b>
(21) <b>Rahvusvah reg jrk</b>	H200400046	
(15) <b>Registreeringu päev</b>	18.06.2004	
(22) <b>Esitamise päev</b>	18.06.2004	
(28) <b>Variantide arv</b>	1	
(72) <b>Autor</b>	Rossana BOFFI, Swatchlab, Via Archimede 6, 20129 Milano, IT	
(73) <b>Omanik</b>	SWATCH AG (SWATCH SA) (SWATCH LTD.), 94, Rue Jakob Stämpfli, CH-2502 BIENNE, CH	
<b>WIPO Rahvusvah Tööstusdisainilahenduste Bületääni nr, kus registreering on avaldatud</b>	2004/07	

(54) **Nimetus** **Wristwatch**

(55) **Reproduksioon**

DM/065503-01





(11) <b>Rahvusvah reg nr</b>	<b>DM/065504</b>	(51) Klass: <b>10-02</b>
(21) <b>Rahvusvah reg jrk</b>	H200400047	
(15) <b>Registreeringu päev</b>	18.06.2004	
(22) <b>Esitamise päev</b>	18.06.2004	
(28) <b>Variantide arv</b>	1	
(72) <b>Autor</b>	Nicole Dupont, Dupont Design SA, 33 route des Jeunes, CH-1227 Carouge/Genève, CH	
(73) <b>Omanik</b>	SWATCH AG (SWATCH SA) (SWATCH LTD.), 94, Rue Jakob Stämpfli, CH-2502 BIENNE, CH	
<b>WIPO Rahvusvah Tööstusdisainilahenduste Bülletääni nr, kus registreering on avaldatud</b>	2004/07	

(54) **Nimetus** **Wristwatch**

(55) **Reproduksioon**

DM/065504-01



- (11) **Rahvusvah reg nr** **DM/065575** (51) Klass: **10-02**
- (21) **Rahvusvah reg jrk** H200400049
- (15) **Registreeringu päev** 20.07.2004
- (22) **Esitamise päev** 20.07.2004
- (28) **Variantide arv** 1
- (72) **Autor** Nicole Dupont, Dupont Design SA, Rte des Jeunes 33,  
CH-1227 CAROUGE, CH
- (73) **Omanik** SWATCH AG (SWATCH SA) (SWATCH LTD.), 94, Rue Jakob Stämpfli,  
CH-2502 BIENNE, CH

**WIPO Rahvusvah Tööstusdisainilahenduste**  
**Bülletääni nr, kus registreering on avaldatud** 2004/07

(54) **Nimetus** **Wristwatch**

(55) **Reproduksioon**

DM/065575-01



(11) <b>Rahvusvah reg nr</b>	<b>DM/065584</b>	(51) Klass: <b>10-02</b>
(21) <b>Rahvusvah reg jrk</b>	H200400050	
(15) <b>Registreeringu päev</b>	19.07.2004	
(22) <b>Esitamise päev</b>	19.07.2004	
(28) <b>Variantide arv</b>	1	
(72) <b>Autor</b>	Adelina BISSOLO, SWATCHLAB, Via Archimede 6, 20129 MILANO, IT	
(73) <b>Omanik</b>	SWATCH AG (SWATCH SA) (SWATCH LTD.), 94, Rue Jakob Stämpfli, CH-2502 BIENNE, CH	
<b>WIPO Rahvusvah Tööstusdisainilahenduste Bülletääni nr, kus registreering on avaldatud</b>	2004/07	

(54) **Nimetus** **Wristwatch**

(55) **Reproduksioon**

DM/065584-01



(11) <b>Rahvusvah reg nr</b>	<b>DM/065585</b>	(51) Klass: <b>10-02</b>
(21) <b>Rahvusvah reg jrk</b>	H200400051	
(15) <b>Registreeringu päev</b>	19.07.2004	
(22) <b>Esitamise päev</b>	19.07.2004	
(28) <b>Variantide arv</b>	1	
(72) <b>Autor</b>	Paula Schulmann, SWATCHLAB, Via Archimede 6, 20129 MILANO, IT	
(73) <b>Omanik</b>	SWATCH AG (SWATCH SA) (SWATCH LTD.), 94, Rue Jakob Stämpfli, CH-2502 BIENNE, CH	
<b>WIPO Rahvusvah Tööstusdisainilahenduste Bülletääni nr, kus registreering on avaldatud</b>	2004/07	

(54) **Nimetus** **Wristwatch**

(55) **Reproduktsoon**

DM/065585-01



(11) <b>Rahvusvah reg nr</b>	<b>DM/065587</b>	(51) Klass: <b>10-07</b>
(21) <b>Rahvusvah reg jrk</b>	H200400053	
(15) <b>Registreeringu päev</b>	19.07.2004	
(22) <b>Esitamise päev</b>	19.07.2004	
(28) <b>Variantide arv</b>	1	
(72) <b>Autor</b>	Rossana BOFFI, Swatchlab, Via Archimede 6, 20129 Milano, IT	
(73) <b>Omanik</b>	SWATCH AG (SWATCH SA) (SWATCH LTD.), 94, Rue Jakob Stämpfli, CH-2502 BIENNE, CH	

**WIPO Rahvusvah Tööstusdisainilahenduste**  
**Bülletääni nr, kus registreering on avaldatud** 2004/07

(54) **Nimetus** **Watch bracelet**

(55) **Reproduktsoon**

DM/065587-01



(11) <b>Rahvusvah reg nr</b>	<b>DM/065588</b>	(51) Klass: <b>11-01</b>
(21) <b>Rahvusvah reg jrk</b>	H200400054	
(15) <b>Registreeringu päev</b>	19.07.2004	
(22) <b>Esitamise päev</b>	19.07.2004	
(28) <b>Komplektide arv</b>	1	
(72) <b>Autor</b>	<i>Autori andmeid ei avalikustata</i>	
(73) <b>Omanik</b>	SWATCH AG (SWATCH SA) (SWATCH LTD.), 94, Rue Jakob Stämpfli, CH-2502 BIENNE, CH	
<b>WIPO Rahvusvah Tööstusdisainilahenduste Bületääni nr, kus registreering on avaldatud</b>	2004/07	

(54) **Nimetus** Jewelry, in particular ring (1), earrings (2), bracelet (3), necklace (4)

(55) **Reproduktsoon**

DM/065588-01

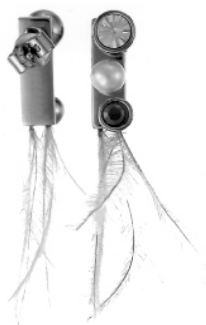
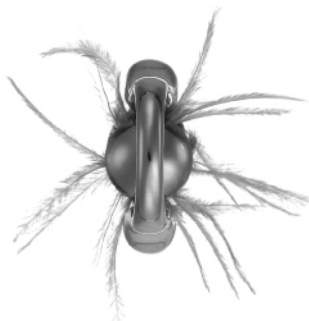



(11) <b>Rahvusvah reg nr</b>	<b>DM/065589</b>	(51) <b>Klass: 10-02</b>
(21) <b>Rahvusvah reg jrk</b>	H200400055	
(15) <b>Registreeringu päev</b>	19.07.2004	
(22) <b>Esitamise päev</b>	19.07.2004	
(28) <b>Variantide arv</b>	1	
(72) <b>Autor</b>	Andrea ARRIGONI, Swatchlab, Via Archimede 6, 20129 Milano, IT	
(73) <b>Omanik</b>	SWATCH AG (SWATCH SA) (SWATCH LTD.), 94, Rue Jakob Stämpfli, CH-2502 BIENNE, CH	
<b>WIPO Rahvusvah Tööstusdisainilahenduste Bülletääni nr, kus registreering on avaldatud</b>	2004/07	

(54) **Nimetus** **Wristwatch**

(55) **Reproduktsoon**

DM/065589-01





(11) <b>Rahvusvah reg nr</b>	<b>DM/065590</b>	(51) Klass: <b>10-02</b>
(21) <b>Rahvusvah reg jrk</b>	H200400056	
(15) <b>Registreeringu päev</b>	20.07.2004	
(22) <b>Esitamise päev</b>	20.07.2004	
(28) <b>Variantide arv</b>	1	
(72) <b>Autor</b>	Nicole Dupont, Dupont Design SA, Rte des Jeunes 33, CH-1227 CAROUGE, CH	
(73) <b>Omanik</b>	SWATCH AG (SWATCH SA) (SWATCH LTD.), 94, Rue Jakob Stämpfli, CH-2502 BIENNE, CH	
<b>WIPO Rahvusvah Tööstusdisainilahenduste Bülletääni nr, kus registreering on avaldatud</b>	2004/07	

(54) **Nimetus** **Wristwatch**

(55) **Reproduksioon**

DM/065590-01



(11) <b>Rahvusvah reg nr</b>	<b>DM/065591</b>	(51) Klass: <b>10-02</b>
(21) <b>Rahvusvah reg jrk</b>	H200400057	
(15) <b>Registreeringu päev</b>	19.07.2004	
(22) <b>Esitamise päev</b>	19.07.2004	
(28) <b>Variantide arv</b>	1	
(72) <b>Autor</b>	Fabio Bucciardini, SWATCHLAB, Via Archimede 6, IT-20129 MILANO, IT	
(73) <b>Omanik</b>	SWATCH AG (SWATCH SA) (SWATCH LTD.), 94, Rue Jakob Stämpfli, CH-2502 BIENNE, CH	
<b>WIPO Rahvusvah Tööstusdisainilahenduste Bülletääni nr, kus registreering on avaldatud</b>	2004/07	

(54) **Nimetus** **Wristwatch**

(55) **Reproduksioon**

DM/065591-01



- (11) **Rahvusvah reg nr** **DM/065594** (51) Klass: **10-02**
- (21) **Rahvusvah reg jrk** H200400060
- (15) **Registreeringu päev** 22.07.2004
- (22) **Esitamise päev** 22.07.2004
- (28) **Variantide arv** 1
- (72) **Autor** Adelina BISSOLO, SWATCHLAB, Via Archimede 6, 20129 MILANO, IT
- (73) **Omanik** SWATCH AG (SWATCH SA) (SWATCH LTD.), 94, Rue Jakob Stämpfli, CH-2502 BIENNE, CH

**WIPO Rahvusvah Tööstusdisainilahenduste**  
**Bülletääni nr, kus registreering on avaldatud** 2004/07

(54) **Nimetus** **Wristwatch**

(55) **Reproduksioon**

DM/065594-01



(11) <b>Rahvusvah reg nr</b>	<b>DM/065601</b>	(51) Klass: <b>10-02</b>
(21) <b>Rahvusvah reg jrk</b>	H200400067	
(15) <b>Registreeringu päev</b>	19.07.2004	
(22) <b>Esitamise päev</b>	19.07.2004	
(28) <b>Variantide arv</b>	1	
(72) <b>Autor</b>	Walter GARRO, SWATCHLAB, Via Archimede 6, IT-20129 MILANO, IT	
(73) <b>Omanik</b>	SWATCH AG (SWATCH SA) (SWATCH LTD.), 94, Rue Jakob Stämpfli, CH-2502 BIENNE, CH	

**WIPO Rahvusvah Tööstusdisainilahenduste  
Bülletääni nr, kus registreering on avaldatud** 2004/07

(54) **Nimetus** **Wristwatch**

(55) **Reproduksioon**

DM/065601-01



(11) <b>Rahvusvah reg nr</b>	<b>DM/065603</b>	(51) Klass: <b>10-02</b>
(21) <b>Rahvusvah reg jrk</b>	H200400069	
(15) <b>Registreeringu päev</b>	19.07.2004	
(22) <b>Esitamise päev</b>	19.07.2004	
(28) <b>Variantide arv</b>	1	
(72) <b>Autor</b>	Fabrizio CUPPINI, SWATCHLAB, Via Archimede 6, IT-20129 MILANO, IT	
(73) <b>Omanik</b>	SWATCH AG (SWATCH SA) (SWATCH LTD.), 94, Rue Jakob Stämpfli, CH-2502 BIENNE, CH	

**WIPO Rahvusvah Tööstusdisainilahenduste  
Bülletääni nr, kus registreering on avaldatud** 2004/07

(54) **Nimetus** **Wristwatch**

(55) **Reproduktsoon**

DM/065603-01



- (11) **Rahvusvah reg nr** DM/065605 (51) Klass: **11-01**
- (21) **Rahvusvah reg jrk** H200400071
- (15) **Registreeringu päev** 20.07.2004
- (22) **Esitamise päev** 20.07.2004
- (28) **Variantide arv** 1
- (72) **Autor** *Autori andmeid ei avalikustata*
- (73) **Omanik** SWATCH AG (SWATCH SA) (SWATCH LTD.), 94, Rue Jakob Stämpfli, CH-2502 BIENNE, CH
- WIPO Rahvusvah Tööstusdisainilahenduste**  
**Bülletääni nr, kus registreering on avaldatud** 2004/07

(54) **Nimetus** Jewelry article

(55) **Reproduktsoon**

DM/065605-01



(11) <b>Rahvusvah reg nr</b>	<b>DM/065607</b>	(51) Klass: <b>10-02</b>
(21) <b>Rahvusvah reg jrk</b>	H200400073	
(15) <b>Registreeringu päev</b>	20.07.2004	
(22) <b>Esitamise päev</b>	20.07.2004	
(28) <b>Variantide arv</b>	2	
(72) <b>Autor</b>	Walter GARRO, SWATCHLAB, Via Archimede 6, IT-20129 MILANO, IT Malcolm DRAGOTTA, SWATCHLAB, Via Archimede 6, IT-20129 Milano, IT	
(73) <b>Omanik</b>	SWATCH AG (SWATCH SA) (SWATCHLTD.), 94, Rue Jakob Stämpfli, CH-2502 BIENNE, CH	
<b>WIPO Rahvusvah Tööstusdisainilahenduste Bülletääni nr, kus registreering on avaldatud</b>	2004/07	

(54) **Nimetus** **Wristwatches**

(55) **Reproduktsoon**

DM/065607-01



DM/065607-02



(11) <b>Rahvusvah reg nr</b>	<b>DM/065608</b>	(51) Klass: <b>10-02</b>
(21) <b>Rahvusvah reg jrk</b>	H200400074	
(15) <b>Registreeringu päev</b>	19.07.2004	
(22) <b>Esitamise päev</b>	19.07.2004	
(28) <b>Variantide arv</b>	2	
(72) <b>Autor</b>	1.1 Malcolm DRAGOTTA, SWATCHLAB, Via Archimede 6, IT-20129 Milano, IT 2.1 Fabrizio CUPPINI, SWATCHLAB, Via Archimede 6, IT-20129 MILANO, IT	
(73) <b>Omanik</b>	SWATCH AG (SWATCH SA) (SWATCHLTD.), 94, Rue Jakob Stämpfli, CH-2502 BIENNE, CH	
<b>WIPO Rahvusvah Tööstusdisainilahenduste Bülletääni nr, kus registreering on avaldatud</b>	2004/07	

(54) **Nimetus** **Wristwatches**

(55) **Reproduksioon**

DM/065608-01



DM/065608-02





(11) <b>Rahvusvah reg nr</b>	<b>DM/065610</b>	(51) Klass: <b>10-02</b>
(21) <b>Rahvusvah reg jrk</b>	H200400076	
(15) <b>Registreeringu päev</b>	20.07.2004	
(22) <b>Esitamise päev</b>	20.07.2004	
(28) <b>Variantide arv</b>	2	
(72) <b>Autor</b>	<i>Autori andmeid ei avalikustata</i>	
(73) <b>Omanik</b>	SWATCH AG (SWATCH SA) (SWATCH LTD.), 94, Rue Jakob Stämpfli, CH-2502 BIENNE, CH	
<b>WIPO Rahvusvah Tööstusdisainilahenduste Bülletääni nr, kus registreering on avaldatud</b>	2004/07	

(54) **Nimetus** **Wristwatches**

(55) **Reproduktsoon**

DM/065610-01



---

DM/065610-02



(11) <b>Rahvusvah reg nr</b>	<b>DM/065701</b>	(51) Klass: <b>10-02</b>
(21) <b>Rahvusvah reg jrk</b>	H200400078	
(15) <b>Registreeringu päev</b>	23.08.2004	
(22) <b>Esitamise päev</b>	23.08.2004	
(28) <b>Variantide arv</b>	1	
(72) <b>Autor</b>	Nicole Dupont, Dupont Design SA, Rte des Jeunes 33, CH-1227 CAROUGE, CH	
(73) <b>Omanik</b>	SWATCH AG (SWATCH SA) (SWATCH LTD.), 94, Rue Jakob Stämpfli, CH-2502 BIENNE, CH	
<b>WIPO Rahvusvah Tööstusdisainilahenduste Bülletääni nr, kus registreering on avaldatud</b>	2004/08	

(54) **Nimetus** **Wristwatch**

(55) **Reproduksioon**

DM/065701-01



(11) <b>Rahvusvah reg nr</b>	<b>DM/065814</b>	(51) Klass: <b>10-02</b>
(21) <b>Rahvusvah reg jrk</b>	H200400081	
(15) <b>Registreeringu päev</b>	31.08.2004	
(22) <b>Esitamise päev</b>	31.08.2004	
(28) <b>Variantide arv</b>	1	
(72) <b>Autor</b>	Malcolm DRAGOTTA, SWATCHLAB, Via Archimede 6, IT-20129 Milano, IT	
(73) <b>Omanik</b>	SWATCH AG (SWATCH SA) (SWATCH LTD.), 94, Rue Jakob Stämpfli, CH-2502 BIENNE, CH	

**WIPO Rahvusvah Tööstusdisainilahenduste  
Bülletääni nr, kus registreering on avaldatud** 2004/09

(54) **Nimetus** **Wristwatch**

(55) **Reproduksioon**

DM/065814-01



(11) <b>Rahvusvah reg nr</b>	<b>DM/065816</b>	(51) Klass: <b>10-02</b>
(21) <b>Rahvusvah reg jrk</b>	H200400083	
(15) <b>Registreeringu päev</b>	31.08.2004	
(22) <b>Esitamise päev</b>	31.08.2004	
(28) <b>Variantide arv</b>	1	
(72) <b>Autor</b>	Nicole Dupont, Dupont Design SA, Rte des Jeunes 33, CH-1227 CAROUGE, CH	
(73) <b>Omanik</b>	SWATCH AG (SWATCH SA) (SWATCH LTD.), 94, Rue Jakob Stämpfli, CH-2502 BIENNE, CH	
<b>WIPO Rahvusvah Tööstusdisainilahenduste Bülletääni nr, kus registreering on avaldatud</b>	2004/09	

(54) **Nimetus** **Wristwatch**

(55) **Reproduksioon**

DM/065816-01



(11) <b>Rahvusvah reg nr</b>	<b>DM/065818</b>	(51) Klass: <b>10-02</b>
(21) <b>Rahvusvah reg jrk</b>	H200400085	
(15) <b>Registreeringu päev</b>	31.08.2004	
(22) <b>Esitamise päev</b>	31.08.2004	
(28) <b>Variantide arv</b>	1	
(72) <b>Autor</b>	Nicole Dupont, Dupont Design SA, Rte des Jeunes 33, CH-1227 CAROUGE, CH	
(73) <b>Omanik</b>	SWATCH AG (SWATCH SA) (SWATCH LTD.), 94, Rue Jakob Stämpfli, CH-2502 BIENNE, CH	

**WIPO Rahvusvah Tööstusdisainilahenduste  
Bülletääni nr, kus registreering on avaldatud** 2004/09

(54) **Nimetus** **Wristwatch**

(55) **Reproduktsoon**

DM/065818-01



- (11) **Rahvusvah reg nr** **DM/065819** (51) Klass: **10-02**
- (21) **Rahvusvah reg jrk** H200400086
- (15) **Registreeringu päev** 31.08.2004
- (22) **Esitamise päev** 31.08.2004
- (28) **Variantide arv** 1
- (72) **Autor** Céline BURKHARDT, Swatch SA, 94 rue Jakob Stämpfli,  
CH-2502 Bienne, CH  
Alfredo BELLAVEGLIA, Swatch SA, 94 rue Jakob Stämpfli,  
CH-2502 Bienne, CH
- (73) **Omanik** SWATCH AG (SWATCH SA) (SWATCHLTD.), 94, Rue Jakob Stämpfli,  
CH-2502 BIENNE, CH
- WIPO Rahvusvah Tööstusdisainilahenduste**  
**Bülletääni nr, kus registreering on avaldatud** 2004/09
- (54) **Nimetus** **Wristwatch**
- (55) **Reproduksioon**
- DM/065819-01



(11) <b>Rahvusvah reg nr</b>	<b>DM/065835</b>	(51) Klass: <b>10-02</b>
(21) <b>Rahvusvah reg jrk</b>	H200400087	
(15) <b>Registreeringu päev</b>	15.09.2004	
(22) <b>Esitamise päev</b>	15.09.2004	
(28) <b>Variantide arv</b>	1	
(72) <b>Autor</b>	Fabrizio CUPPINI, SWATCHLAB, Via Archimede 6, IT-20129 MILANO, IT	
(73) <b>Omanik</b>	SWATCH AG (SWATCH SA) (SWATCH LTD.), 94, Rue Jakob Stämpfli, CH-2502 BIENNE, CH	

**WIPO Rahvusvah Tööstusdisainilahenduste  
Bülletääni nr, kus registreering on avaldatud** 2004/09

(54) **Nimetus** **Wristwatch**

(55) **Reproduktsoon**

DM/065835-01



(11) <b>Rahvusvah reg nr</b>	<b>DM/065875</b>	(51) Klass: <b>11-01</b>
(21) <b>Rahvusvah reg jrk</b>	H200400090	
(15) <b>Registreeringu päev</b>	22.09.2004	
(22) <b>Esitamise päev</b>	22.09.2004	
(28) <b>Komplektide arv</b>	1	
(72) <b>Autor</b>	Arlette Elsa EMCH DUCOMMUN, rue des Mornets 31, CH-2550 La Neuveville, CH	
(73) <b>Omanik</b>	OMEGA SA (OMEGA AG) (OMEGA LTD.), Jakob-Stämpfli-Strasse 96, CH-2502 Biel/Bienne, CH	
<b>WIPO Rahvusvah Tööstusdisainilahenduste Bülletääni nr, kus registreering on avaldatud</b>	2004/09	

(54) **Nimetus** Jewellery, including ring (1), earrings (2), pendant (3)

(55) **Reproduktsoon**

DM/065875-01





(11) <b>Rahvusvah reg nr</b>	<b>DM/065883</b>	(51) Klass: <b>10-07</b>
(21) <b>Rahvusvah reg jrk</b>	H200400091	
(15) <b>Registreeringu päev</b>	24.09.2004	
(22) <b>Esitamise päev</b>	24.09.2004	
(28) <b>Variantide arv</b>	1	
(72) <b>Autor</b>	Vincent LAUCELLA, Montres Breguet S.A., CH-1344 L'Abbaye, CH	
(73) <b>Omanik</b>	MONTRES BREGUET S.A., CH-1344 L'ABBAYE, CH	
<b>WIPO Rahvusvah Tööstusdisainilahenduste</b>		
<b>Bülletääni nr, kus registreering on avaldatud</b>	2004/09	

(54) **Nimetus** **Hinged clasp for watch straps**

(55) **Reproduksioon**

DM/065883-01

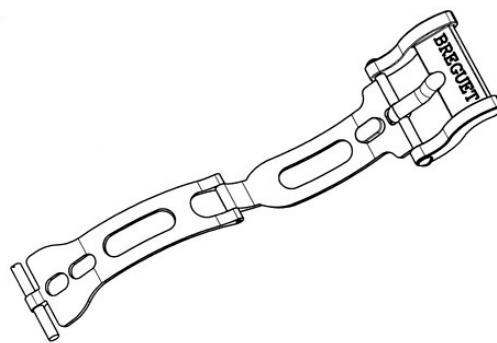
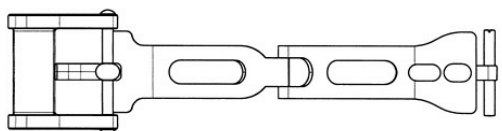
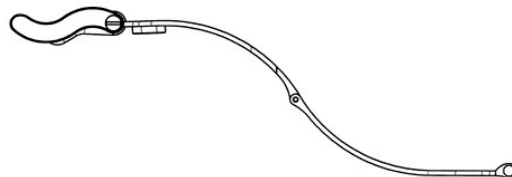
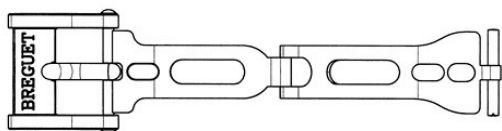

**III. REGISTREERINGU KEHTIVUSE PIKENDAMINE**

(11)	(18)		
00423	03.12.2009	00452	24.03.2010
00424	03.12.2009	00454	03.04.2010
00425	03.12.2009	00455	03.04.2010
00426	03.12.2009	00458	11.04.2010
00427	03.12.2009	00467	03.04.2010
00428	03.12.2009	00487	06.07.2010
00429	03.12.2009	00488	06.07.2010
00451	24.03.2010		

**IV. TÖÖSTUSDISAINILAHENDUSE ÜLEMINEK**

Reg nr	Uue omaniku andmed	Registrikande jõustumise päev
00691	Breyfield Trust Reg., Haus Rechsteiner, Städtle 31, P.O. Box 328, LI-9490 Vaduz, LI	28.01.2005
00752	Peeter Kuum, Neeme küla, Jõelähtme vald, 74203 Harju maakond, EE	27.01.2005

**VI. MUUD REGISTREERINGU ANDMETE MUUDATUSED**

Reg nr	Muudetud andmed	Registrikande jõustumise päev
00423-00429	Sony Computer Entertainment Inc., 2-6-21 Minami-Aoyama, Minato-ku, Tokyo, JP	08.02.2005
00592	AS NEOQI, Piirimäe 15, Tănassilma küla, Saku vald, 76401 Harju maakond, EE	14.04.2005
00654	AS NEOQI, Piirimäe 15, Tănassilma küla, Saku vald, 76401 Harju maakond, EE	14.04.2005
00948-00954	AS NEOQI, Piirimäe 15, Tănassilma küla, Saku vald, 76401 Harju maakond, EE	14.04.2005
01027	AS NEOQI, Piirimäe 15, Tănassilma küla, Saku vald, 76401 Harju maakond, EE	14.04.2005

Reg nr	Muudetud andmed	Registrikande jõustumise päev
00487, 00488	esindaja andmed kustutatud	11.02.2005
00592	Mart Enn Koppel	14.04.2005
00654	Mart Enn Koppel	14.04.2005
00948-00954	Mart Enn Koppel	14.04.2005

**XI. TÖÖSTUSDISAINILAHENDUSE KUSTUTAMINE REGISTRIST**

"Tööstusdisaini kaitse seaduse" paragrahvi 77 lõike 1 alusel on registrist kustutatud järgmised tööstusdisainilahendused:

Reg nr	Kustutamise jõustumise päev
00380	27.07.2004
00384	02.09.2004
00385	02.09.2004
00386	03.09.2004
00402	20.10.2004
00412	13.09.2004
00414	13.09.2004
00478	26.08.2004
00502	26.08.2004

## XII. LOENDID

## REGISTREERITUD TÖÖSTUSDISAINILAHENDUSTE SÜSTEMAATILINE LOEND

Rahvusvahelise klassifikatsiooni klass ja alaklass(id)	Registreerimis-taotluse number	Registreeringu number			
02-02	D200400071	01060	14-03	D200400124	01055
02-02	D200400147	01061	14-03	D200400125	01046
02-02	D200400148	01062	14-03	D200400126	01056
02-02	D200400149	01063	14-03	D200400134	01048
02-07	D200400071	01060	14-03	D200400138	01049
02-07	D200400147	01061	14-03	D200400139	01050
02-07	D200400148	01062	14-03	D200400140	01051
02-07	D200400149	01063	14-03	D200400141	01052
06-06	D200400146	01044	14-03	D200400147	01061
07-02	D200500001	01057	14-03	D200400148	01062
09-01	D200400133	01047	14-03	D200400149	01063
09-01	D200500003	01058	14-03	D200500010	01059
09-03	D200500002	01064	14-03	D200500011	01066
14-02	D200500011	01066	14-03	D200500012	01067
14-02	D200500012	01067	14-03	D200500013	01068
14-02	D200500013	01068	19-08	D200500002	01064
14-03	D200400071	01060	19-08	D200500004	01065
14-03	D200400106	01041	23-02	D200400145	01054
14-03	D200400107	01042	23-04	D200500014	01069
14-03	D200400108	01043	25-01	D200400070	01040
14-03	D200400123	01045	25-02	D200400144	01053

## REGISTREERITUD TÖÖSTUSDISAINILAHENDUSTE REGISTREERIMISTAOTLUSTE NUMBRILINE LOEND

Registreerimis-taotluse number	Registreeringu number	Rahvusvahelise klassifikatsiooni klass(id) ja alaklass(id)			
D200400070	01040	25-01	D200400147	01061	02-07
D200400071	01060	02-02	D200400147	01061	14-03
D200400071	01060	02-07	D200400148	01062	02-02
D200400071	01060	14-03	D200400148	01062	02-07
D200400106	01041	14-03	D200400148	01062	14-03
D200400107	01042	14-03	D200400149	01063	02-02
D200400108	01043	14-03	D200400149	01063	02-07
D200400123	01045	14-03	D200400149	01063	14-03
D200400124	01055	14-03	D200500001	01057	07-02
D200400125	01046	14-03	D200500002	01064	09-03
D200400126	01056	14-03	D200500002	01064	19-08
D200400133	01047	09-01	D200500003	01058	09-01
D200400134	01048	14-03	D200500004	01065	19-08
D200400138	01049	14-03	D200500010	01059	14-03
D200400139	01050	14-03	D200500011	01066	14-02
D200400140	01051	14-03	D200500011	01066	14-03
D200400141	01052	14-03	D200500012	01067	14-02
D200400144	01053	25-02	D200500012	01067	14-03
D200400145	01054	23-02	D200500013	01068	14-02
D200400146	01044	06-06	D200500013	01068	14-03
D200400147	01061	02-02	D200500014	01069	23-04

**AVALDATUD RAHVUSVAHELISE REGISTREERINGU REGISTREERIMISE  
OTSUSE TEADETE NUMBRILINE LOEND**

DM/065284	DM/065371	DM/065499	DM/065603
DM/065294	DM/065380	DM/065501	DM/065605
DM/065297	DM/065392	DM/065503	DM/065607
DM/065299	DM/065393	DM/065504	DM/065608
DM/065313	DM/065394	DM/065575	DM/065610
DM/065314	DM/065459	DM/065584	DM/065701
DM/065344	DM/065465	DM/065585	DM/065814
DM/065347	DM/065467	DM/065587	DM/065816
DM/065360	DM/065468	DM/065588	DM/065818
DM/065362	DM/065473	DM/065589	DM/065819
DM/065366	DM/065474	DM/065590	DM/065835
DM/065368	DM/065475	DM/065591	DM/065875
DM/065369	DM/065480	DM/065594	DM/065883
DM/065370	DM/065494	DM/065601	

**XIII. TÖÖSTUSDISAINIALASED ÕIGUSAKTID JA MUU INFO****RIIKLIKUS PATENDIVOLNIKE REGISTRIS REGISTREERITUD PATENDIVOLNIKE NIMEKIRI**  
(seisuga 29. märts 2005)

Register on asutatud 1. septembril 2001. a Vabariigi Valitsuse 7. augusti 2001. a määrusega nr 271 "Riikliku patendivolinike registri asutamine ja registri pidamise põhimäärus" (RT I 2001, 70, 426) patendivoliniku seaduse § 21 alusel (RT I 2001, 27, 151).

**TEGEVUSVALDKOND: KAUBAMÄRK, TÖÖSTUSDISAINILAHENDUS JA GEOGRAAFILINE TÄHIS**

- |                              |   |                       |   |
|------------------------------|---|-----------------------|---|
| <b>Arno ANIJALG</b>          | <b>OÜ USTERVALL</b><br>Raekoja plats 16<br>51004 Tartu<br>pk 21, 50002 Tartu<br>telefon: 744 1980<br>telefaks: 744 1785<br>e-post: anijalg@ustervall.ee<br><a href="http://www.ustervall.ee">http://www.ustervall.ee</a><br>võõrkeeled: saksa, vene | <b>Juhan HÄMMALOV</b> | <b>OÜ Intels</b><br>Riia 11-3<br>51010 Tartu<br>telefon: 742 0401<br>telefaks: 742 0326<br>e-post: intelses@estpak.ee<br>võõrkeeled: inglise, saksa, vene   |
| <b>Aivo ARULA</b>            | <b>Patendibüroo Käosaar &amp; Co OÜ</b><br>Tähe 94<br>50107 Tartu<br>telefon: 738 3051<br>telefaks: 738 3055<br>e-post: info@kaosaar.ee<br><a href="http://www.kaosaar.ee">http://www.kaosaar.ee</a><br>võõrkeeled: inglise, vene                   | <b>Uno JÄÄGER</b>     | <b>Inseneribüroo Uneko OÜ</b><br>Rüütli 51a, 80010 Pärnu<br>telefon: 447 1021<br>telefaks: 447 1001<br>GSM: 515 1844<br>e-post: uno@estpak.ee<br>võõrkeeled: inglise, soome, vene   |
| <b>Martina BÖCKLER-LORVI</b> | <b>OÜ LASVET</b><br>Suurtüki 4a, 10133 Tallinn<br>pk 3136, 10505 Tallinn<br>telefon: 640 6600<br>telefaks: 640 6604<br>e-post: lasvet@lasvet.ee<br><a href="http://www.lasvet.ee">http://www.lasvet.ee</a><br>võõrkeeled: inglise, vene, soome      | <b>Sirje KAHU</b>     | <b>OÜ USTERVALL</b><br>Raekoja plats 16<br>51004 Tartu<br>pk 21, 50002 Tartu<br>telefon: 744 1980<br>telefaks: 744 1785<br>e-post: skahu@ustervall.ee<br><a href="http://www.ustervall.ee">http://www.ustervall.ee</a><br>võõrkeeled: inglise, vene                       |
| <b>Indrek EELMETS</b>        | <b>OÜ LASVET</b><br>Suurtüki 4a, 10133 Tallinn<br>pk 3136, 10505 Tallinn<br>telefon: 640 6600<br>telefaks: 640 6604<br>e-post: lasvet@lasvet.ee<br><a href="http://www.lasvet.ee">http://www.lasvet.ee</a><br>võõrkeeled: inglise, vene, soome      | <b>Lembit KALEV</b>   | <b>Patendibüroo ROOSILLA OÜ</b><br>Järveotsa tee 39-61<br>13520 Tallinn<br>telefon: 657 1722, 657 5381<br>telefaks: 657 5381<br>GSM: 511 9951<br>e-post: roosilla@roosilla.ee<br><a href="http://www.roosilla.ee">http://www.roosilla.ee</a><br>võõrkeeled: inglise, vene |
| <b>Alla HÄMMALOV</b>         | <b>OÜ Intels</b><br>Riia 11-3<br>51010 Tartu<br>telefon: 742 0401<br>telefaks: 742 0326<br>e-post: intelses@estpak.ee<br>võõrkeeled: inglise, poola, vene   | <b>Anneli KANG</b>    | <b>OÜ Synest</b><br>pk 977, 13402 Tallinn<br>telefon: 660 9786<br>telefaks: 660 9787<br>e-post: anneli@synest.ee<br>võõrkeeled: inglise, saksa, vene, prantsuse, soome, rootsi  |

- Urmas KAULER**      **Patendibüroo TURVAJA OÜ**  
Liivalaia 22  
10118 Tallinn  
telefon: 640 3109  
telefaks: 640 3105  
e-post: kauler@turvaja.ee  
http://www.turvaja.ee  
võõrkeeled: inglise, vene, soome
- Urmas KERNU**      **AAA Patendibüroo OÜ**  
Tartu mnt 16  
10117 Tallinn  
pk 3926, 10509 Tallinn  
telefon: 660 5910, 660 5911  
telefaks: 660 5912  
e-post: aaa@aaa.ee  
http://www.aaa.ee  
võõrkeeled: inglise, saksa, soome, vene
- Ljubov KESSELMAN**      **OÜ Kesna**  
Tedre 77-52  
10616 Tallinn  
telefon: 660 8068  
telefaks: 660 8069  
e-post: kesna@online.ee  
võõrkeeled: inglise, vene
- Marina KESSELMAN**      **OÜ Kesna**  
Tedre 77-52  
10616 Tallinn  
telefon: 660 8068  
telefaks: 660 8069  
e-post: kesna@online.ee  
võõrkeeled: inglise, saksa, vene
- Heinu KOITEL**      **Patendi- & Kaubamärgibüroo Koitel OÜ**  
Tartu mnt 65  
10115 Tallinn  
pk 1759, 10902 Tallinn  
telefon: 603 3260  
telefaks: 603 3261  
e-post: koitel@koitel.ee  
http://www.koitel.ee  
võõrkeeled: inglise, soome, vene
- Raivo KOITEL**      **Patendi- & Kaubamärgibüroo Koitel OÜ**  
Tartu mnt 65  
10115 Tallinn  
pk 1759, 10902 Tallinn  
telefon: 603 3260  
telefaks: 603 3261  
e-post: koitel@koitel.ee  
http://www.koitel.ee  
võõrkeeled: inglise, soome, vene
- Mart Enn KOPPEL**      **Patendibüroo Koppel OÜ**  
Kajaka 4-10  
11317 Tallinn  
telefon: 677 4136  
telefaks: 677 4138  
e-post: info@koppelpb.com  
http://www.koppelpb.com  
võõrkeeled: inglise, vene, soome
- Heinrich KRUPP**      **Patendibüroo TURVAJA OÜ**  
Liivalaia 22  
10118 Tallinn  
telefon: 640 3109  
telefaks: 640 3105  
e-post: turvaja@turvaja.ee  
http://www.turvaja.ee  
võõrkeeled: saksa, vene
- Jüri KÄOSAAR**      **Patendibüroo Käosaar & Co OÜ**  
Tähe 94  
50107 Tartu  
telefon: 738 3051  
telefaks: 738 3055  
e-post: info@kaosaar.ee  
http://www.kaosaar.ee  
võõrkeeled: inglise, vene
- Kalev KÄOSAAR**      **Patendibüroo Käosaar & Co OÜ**  
Peterburi tee 46  
11415 Tallinn  
telefon: 637 9484  
telefaks: 637 9485  
e-post: kalev.kaosaar@kaosaar.ee  
http://www.kaosaar.ee  
võõrkeeled: inglise, vene
- Reet MAASIKAMÄE**      **OÜ Kaitsepurus**  
Mulla 4-3  
10611 Tallinn  
telefon: 673 9097, 633 2798  
telefaks: 677 4844  
e-post: purus@online.ee  
purus@hot.ee  
http://www.hot.ee/purus/  
võõrkeeled: inglise, vene
- Raivo MATSOO**      **RM Hirvela Patendibüroo OÜ**  
Saku 15, 11314 Tallinn  
telefon: 614 0816  
telefaks: 614 0818  
e-post: hirvela@hirvela.ee  
võõrkeeled: inglise, vene

- Elle MELLIK**      **AAA Patendibüroo OÜ**  
Tartu mnt 16  
10117 Tallinn  
pk 3926, 10509 Tallinn  
telefon: 660 5910, 660 5911  
telefaks: 660 5912  
e-post: aaa@aaa.ee  
http://www.aaa.ee  
võõrkeeled: inglise, vene
- Lembit MITT**      **AAA Patendibüroo OÜ**  
Tartu mnt 16  
10117 Tallinn  
pk 3926, 10509 Tallinn  
telefon: 660 5910, 660 5911  
telefaks: 660 5912  
e-post: aaa@aaa.ee  
http://www.aaa.ee  
võõrkeeled: inglise, vene
- Ott MOORLAT**      **OÜ Moorlat & Ko Patendibüroo**  
pk 723, 12902 Tallinn  
telefon: 655 0450, 654 2844  
telefaks: 654 2844  
e-post: ott.moorlat@moorlat.ee  
http://www.moorlat.ee  
võõrkeeled: inglise, vene
- Anfia MORNA**      **Patendibüroo TURVAJA OÜ**  
Liivalaia 22, 10118 Tallinn  
telefon: 640 3109  
telefaks: 640 3105  
e-post: morna@turvaja.ee  
http://www.turvaja.ee  
võõrkeeled: inglise, vene
- Tõnu NELAS**      **AAA Patendibüroo OÜ**  
Tartu mnt 16  
10117 Tallinn  
pk 3926, 10509 Tallinn  
telefon: 660 5910, 660 5911  
telefaks: 660 5912  
e-post: aaa@aaa.ee  
http://www.aaa.ee  
võõrkeeled: inglise, vene, soome
- Jüri OLT**      **Patendibüroo Käosaar & Co OÜ**  
Tähe 94, 50107 Tartu  
telefon: 738 3051  
telefaks: 738 3055  
e-post: info@kaosaar.ee  
http://www.kaosaar.ee  
võõrkeeled: inglise, saksa, soome, vene
- Jaak OSTRAT**
- Villu PAVELTS**
- Toom PUNGAS**
- Kaie PUUR**
- Riina PÄRN**
- Tarmo ROSMAN**
- Arvo SALUMÄE**
- OÜ LASVET**  
Suurtüki 4a, 10133 Tallinn  
pk 3136, 10505 Tallinn  
telefon: 640 6600  
telefaks: 640 6604  
e-post: lasvet@lasvet.ee  
http://www.lasvet.ee  
võõrkeeled: inglise, saksa, soome, vene
- OÜ LASVET**  
Suurtüki 4a, 10133 Tallinn  
pk 3136, 10505 Tallinn  
telefon: 640 6600  
telefaks: 640 6604  
e-post: lasvet@lasvet.ee  
http://www.lasvet.ee  
võõrkeeled: inglise, soome, vene
- OÜ Synest**  
pk 977, 13402 Tallinn  
telefon: 660 9786  
telefaks: 660 9787  
e-post: toom@synest.ee  
võõrkeeled: inglise, saksa, soome, vene
- Patendibüroo Käosaar & Co OÜ**  
Tähe 94  
50107 Tartu  
telefon: 738 3051  
telefaks: 738 3055  
e-post: info@kaosaar.ee  
http://www.kaosaar.ee  
võõrkeeled: inglise, vene
- OÜ Intels**  
Riia 11-3  
51010 Tartu  
telefon: 742 0401  
telefaks: 742 0326  
e-post: intelses@estpak.ee  
võõrkeeled: inglise, vene
- Rosman ja Partnerid OÜ**  
pk 652, 12602 Tallinn  
telefon: 656 1450  
telefaks: 656 1450  
e-post: tarman@cc.ttu.ee  
võõrkeeled: saksa, inglise, ungari, vene
- OÜ Amende Patendibüroo**  
Raua 65  
10152 Tallinn  
telefon: 648 6125  
telefaks: 641 0174  
e-post: amende@hot.ee  
võõrkeeled: inglise, saksa, soome, vene



**Almar SEHVER****AAA Patendibüroo OÜ**

Tartu mnt 16  
10117 Tallinn  
pk 3926, 10509 Tallinn  
telefon: 660 5910, 660 5911  
telefaks: 660 5912  
e-post: aaa@aaa.ee  
<http://www.aaa.ee>  
võõrkeeled: inglise, vene

**Enn URGAS****Patendibüroo TURVAJA OÜ**

Liivalaia 22  
10118 Tallinn  
telefon: 640 3109  
telefaks: 640 3105  
e-post: [urgas@turvaja.ee](mailto:urgas@turvaja.ee)  
<http://www.turvaja.ee>  
võõrkeeled: inglise, vene

**Harald TEHVER****Patendibüroo TURVAJA OÜ**

Liivalaia 22  
10118 Tallinn  
telefon: 640 3109  
telefaks: 640 3105  
e-post: [tehver@turvaja.ee](mailto:tehver@turvaja.ee)  
<http://www.turvaja.ee>  
võõrkeeled: inglise, saksa, vene

**Juta-Maris UUSTALU****OÜ LASVET**

Suurtüki 4a, 10133 Tallinn  
pk 3136, 10505 Tallinn  
telefon: 640 6600  
telefaks: 640 6604  
e-post: [lasvet@lasvet.ee](mailto:lasvet@lasvet.ee)  
<http://www.lasvet.ee>  
võõrkeeled: inglise, vene

**Olga TREUFELDT****Patendibüroo TURVAJA OÜ**

Liivalaia 22  
10118 Tallinn  
telefon: 640 3109  
telefaks: 640 3105  
e-post: [olga@turvaja.ee](mailto:olga@turvaja.ee)  
<http://www.turvaja.ee>  
võõrkeeled: inglise, vene

**LIST OF PATENT ATTORNEYS, REGISTERED IN  
THE ESTONIAN STATE REGISTER OF PATENT ATTORNEYS  
(by 29 March 2005)**

Register is established on September 1<sup>st</sup> 2001

**FIELD OF ACTIVITY: TRADEMARKS, INDUSTRIAL DESIGNS AND GEOGRAPHICAL INDICATIONS**

<b>Arno ANIJALG</b>	<b>USTERVALL Ltd.</b> Raekoja plats 16 51004 Tartu, Estonia P.O. Box 21 50002 Tartu, Estonia Phone: +372 744 1980 Fax: +372 744 1785 E-mail: anijalg@ustervall.ee Http://www.ustervall.ee German, Russian, Estonian	<b>Juhan HÄMMALOV</b>	<b>Intels Ltd.</b> Riia Str. 11-3 51010 Tartu, Estonia Phone: +372 742 0401 Fax: +372 742 0326 E-mail: intelses@estpak.ee English, German, Russian, Estonian
<b>Aivo ARULA</b>	<b>Patent Agency Käosaar &amp; Co</b> Tähe Str. 94 50107 Tartu, Estonia Phone: +372 738 3051 Fax: +372 738 3055 E-mail: info@kaosaar.ee Http://www.kaosaar.ee English, Russian, Estonian	<b>Uno JÄÄGER</b>	<b>Inseneribüroo Uneko Ltd.</b> Rüütli 51a 80010 Pärnu, Estonia Phone: +372 447 1021 Fax: +372 447 1001 GSM: +372 515 1844 E-mail: uno@estpak.ee English, Finnish, Russian, Estonian
<b>Martina BÖCKLER-LORVI</b>	<b>Lasvet Ltd.</b> P.O. Box 3136 10505 Tallinn, Estonia Phone: +372 640 6600 Fax: +372 640 6604 E-mail: lasvet@lasvet.ee Http://www.lasvet.ee English, Russian, Finnish, Estonian	<b>Sirje KAHU</b>	<b>USTERVALL Ltd.</b> Raekoja plats 16 51004 Tartu, Estonia P.O. Box 21 50002 Tartu, Estonia Phone: +372 744 1980 Fax: +372 744 1785 E-mail: skahu@ustervall.ee Http://www.ustervall.ee English, Russian, Estonian
<b>Indrek EELMETS</b>	<b>Lasvet Ltd.</b> P.O. Box 3136 10505 Tallinn, Estonia Phone: +372 640 6600 Fax: +372 640 6604 E-mail: lasvet@lasvet.ee Http://www.lasvet.ee English, Finnish, Russian, Estonian	<b>Lembit KALEV</b>	<b>Patent Bureau ROOSILLA Ltd.</b> Järveotsa Road 39-61 13520 Tallinn, Estonia Phone: +372 657 1722 +372 657 5381 Fax: +372 657 5381 GSM: +372 511 9951 E-mail: roosilla@roosilla.ee Http://www.roosilla.ee English, Russian, Estonian
<b>Alla HÄMMALOV</b>	<b>Intels Ltd.</b> Riia Str. 11-3 51010 Tartu, Estonia Phone: +372 742 0401 Fax: +372 742 0326 E-mail: intelses@estpak.ee English, Polish, Russian, Estonian	<b>Anneli KANG</b>	<b>Synest Ltd.</b> P.O. Box 977 13402 Tallinn, Estonia Phone: +372 660 9786 Fax: +372 660 9787 E-mail: anneli@synest.ee English, German, Russian, French, Finnish, Swedish, Estonian

- Urmast KAULER**      **Patendibüroo TURVAJA OÜ**  
 Liivalaia 22  
 10118 Tallinn, Estonia  
 Phone: +372 640 3109  
 Fax: +372 640 3105  
 E-mail: kauler@turvaja.ee  
 Http://www.turvaja.ee  
 English, Russian, Finnish,  
 Estonian
- Urmast KERNU**      **AAA Legal Services**  
 Tartu Road 16  
 10117 Tallinn, Estonia  
 P.O. Box 3926  
 10509 Tallinn, Estonia  
 Phone: +372 660 5910  
 +372 660 5911  
 Fax: +372 660 5912  
 E-mail: aaa@aaa.ee  
 Http://www.aaa.ee  
 English, German, Finnish,  
 Russian, Estonian
- Marina KESSELMAN**      **Kesna Ltd.**  
 Tedre Str. 77-52  
 10616 Tallinn, Estonia  
 Phone: +372 660 8068  
 Fax: +372 660 8069  
 E-mail: kesna@online.ee  
 English, German, Russian,  
 Estonian
- Ljubov KESSELMAN**      **Kesna Ltd.**  
 Tedre Str. 77-52  
 10616 Tallinn, Estonia  
 Phone: +372 660 8068  
 Fax: +372 660 8069  
 E-mail: kesna@online.ee  
 English, Russian, Estonian
- Heinu KOITEL**      **Patent- & Trademark Office  
 Koitel Ltd.**  
 Tartu Road 65  
 10115 Tallinn, Estonia  
 P.O. Box 1759  
 10902 Tallinn, Estonia  
 Phone: +372 603 3260  
 Fax: +372 603 3261  
 E-mail: koitel@koitel.ee  
 Http://www.koitel.ee  
 English, Finnish, Russian,  
 Estonian
- Raivo KOITEL**      **Patent- & Trademark Office  
 Koitel Ltd.**  
 Tartu Road 65  
 10115 Tallinn, Estonia  
 P.O. Box 1759  
 10902 Tallinn, Estonia  
 Phone: +372 603 3260  
 Fax: +372 603 3261  
 E-mail: koitel@koitel.ee  
 Http://www.koitel.ee  
 English, Finnish, Russian,  
 Estonian
- Mart Enn KOPPEL**      **Patent Bureau Koppel**  
 Kajaka 4-10  
 11317 Tallinn, Estonia  
 Phone: +372 677 4136  
 Fax: +372 677 4138  
 E-mail: info@koppelpb.com  
 Http://www.koppelpb.com  
 English, Russian, Finnish,  
 Estonian
- Heinrich KRUPP**      **Patendibüroo TURVAJA OÜ**  
 Liivalaia 22  
 10118 Tallinn, Estonia  
 Phone: +372 640 3109  
 Fax: +372 640 3105  
 E-mail: turvaja@turvaja.ee  
 Http://www.turvaja.ee  
 German, Russian, Estonian
- Jüri KÄOSAAR**      **Patent Agency Käosaar & Co**  
 Tähe Str. 94  
 50107 Tartu, Estonia  
 Phone: +372 738 3051  
 Fax: +372 738 3055  
 E-mail: info@kaosaar.ee  
 Http://www.kaosaar.ee  
 English, Russian, Estonian
- Kalev KÄOSAAR**      **Patent Agency Käosaar & Co**  
 Peterburi Road 46  
 11415 Tallinn, Estonia  
 Phone: +372 637 9484  
 Fax: +372 637 9485  
 E-mail:  
 kalev.kaosaar@kaosaar.ee  
 Http://www.kaosaar.ee  
 English, Russian, Estonian

- Reet MAASIKAMÄE** **Patent Bureau Kaitsepurus Ltd.**  
Mulla Str. 4-3  
10611 Tallinn, Estonia  
Phone: +372 673 9097  
+372 633 2798  
Fax: +372 677 4844  
E-mail: purus@online.ee  
purus@hot.ee  
Http://www.hot.ee/purus/  
English, Russian, Estonian
- Raivo MATSOO** **RM Hirvela Patent Bureau Ltd**  
Saku 15, 11314 Tallinn, Estonia  
Phone: +372 614 0816  
Fax: +372 614 0818  
E-mail: hirvela@hirvela.ee  
English, Russian, Estonian
- Elle MELLIK** **AAA Legal Services**  
Tartu Road 16  
10117 Tallinn, Estonia  
P.O. Box 3926  
10509 Tallinn, Estonia  
Phone: +372 660 5910  
+372 660 5911  
Fax: +372 660 5912  
E-mail: aaa@aaa.ee  
Http://www.aaa.ee  
English, Russian, Estonian
- Lembit MITT** **AAA Legal Services**  
Tartu Road 16  
10117 Tallinn, Estonia  
P.O. Box 3926  
10509 Tallinn, Estonia  
Phone: +372 660 5910  
+372 660 5911  
Fax: +372 660 5912  
E-mail: aaa@aaa.ee  
Http://www.aaa.ee  
English, Russian, Estonian
- Ott MOORLAT** **Moorlat & Co Ltd. Patent Bureau**  
P.O. Box 723  
12902 Tallinn, Estonia  
Phone: +372 655 0450  
+372 654 2844  
Fax: +372 654 2844  
E-mail: ott.moorlat@moorlat.ee  
Http://www.moorlat.ee  
English, Russian, Estonian
- Anfia MORNA**
- Tõnu NELSAS**
- Jüri OLT**
- Jaak OSTRAT**
- Villu PAVELTS**
- Toom PUNGAS**
- Patendibüroo TURVAJA OÜ**  
Liivalaia 22  
10118 Tallinn, Estonia  
Phone: +372 640 3109  
Fax: +372 640 3105  
E-mail: morna@turvaja.ee  
Http://www.turvaja.ee  
English, Russian, Estonian
- AAA Legal Services**  
Tartu Road 16  
10117 Tallinn, Estonia  
P.O. Box 3926  
10509 Tallinn, Estonia  
Phone: +372 660 5910  
+372 660 5911  
Fax: +372 660 5912  
E-mail: aaa@aaa.ee  
Http://www.aaa.ee  
English, Russian, Finnish, Estonian
- Patent Agency Käosaar & Co**  
Tähe Str. 94  
50107 Tartu, Estonia  
Phone: +372 738 3051  
Fax: +372 738 3055  
E-mail: info@kaosaar.ee  
Http://www.kaosaar.ee  
English, German, Finnish, Russian, Estonian
- Lasvet Ltd.**  
P.O. Box 3136  
10505 Tallinn, Estonia  
Phone: +372 640 6600  
Fax: +372 640 6604  
E-mail: lasvet@lasvet.ee  
Http://www.lasvet.ee  
English, German, Finnish, Russian, Estonian
- Lasvet Ltd.**  
P.O. Box 3136  
10505 Tallinn, Estonia  
Phone: +372 640 6600  
Fax: +372 640 6604  
E-mail: lasvet@lasvet.ee  
Http://www.lasvet.ee  
English, Finnish, Russian, Estonian
- Synest Ltd.**  
P.O. Box 977  
13402 Tallinn, Estonia  
Phone: +372 660 9786  
Fax: +372 660 9787  
E-mail: toom@synest.ee  
English, German, Finnish, Russian, Estonian

- Kaie PUUR**      **Patent Agency Käosaar & Co**  
Tähe Str. 94  
50107 Tartu, Estonia  
Phone: +372 738 3051  
Fax: +372 738 3055  
E-mail: info@kaosaar.ee  
Http://www.kaosaar.ee  
English, Russian, Estonian
- Harald TEHVER**      **Patendibüroo TURVAJA OÜ**  
Liivalaia 22  
10118 Tallinn, Estonia  
Phone: +372 640 3109  
Fax: +372 640 3105  
E-mail: tehver@turvaja.ee  
Http://www.turvaja.ee  
English, German, Russian,  
Estonian
- Riina PÄRN**      **Intels Ltd.**  
Riia Str. 11-3  
51010 Tartu, Estonia  
Phone: +372 742 0401  
Fax: +372 742 0326  
E-mail: intelses@estpak.ee  
English, Russian,  
Estonian
- Olga TREUFELDT**      **Patendibüroo TURVAJA OÜ**  
Liivalaia 22  
10118 Tallinn, Estonia  
Phone: +372 640 3109  
Fax: +372 640 3105  
E-mail: olga@turvaja.ee  
Http://www.turvaja.ee  
English, Russian, Estonian
- Tarmo ROSMAN**      **Rosman and Partners Ltd.**  
P.O. Box 652  
12602 Tallinn, Estonia  
Phone: +372 656 1450  
Fax: +372 656 1450  
E-mail: tarman@cc.ttu.ee  
German, English, Hungarian,  
Russian, Estonian
- Enn URGAS**      **Patendibüroo TURVAJA OÜ**  
Liivalaia 22  
10118 Tallinn, Estonia  
Phone: +372 640 3109  
Fax: +372 640 3105  
E-mail: urgas@turvaja.ee  
Http://www.turvaja.ee  
English, Russian, Estonian
- Arvo SALUMÄE**      **AMENDE Patent Agency Ltd.**  
Raua 65, 10152 Tallinn, Estonia  
Phone: +372 648 6125  
Fax: +372 641 0174  
E-mail: amende@hot.ee  
English, German, Finnish,  
Russian, Estonian
- Juta-Maris UUSTALU**      **Lasvet Ltd.**  
P.O. Box 3136  
10505 Tallinn, Estonia  
Phone: +372 640 6600  
Fax: +372 640 6604  
E-mail: lasvet@lasvet.ee  
Http://www.lasvet.ee  
English, Russian, Estonian
- Almar SEHVER**      **AAA Legal Services**  
Tartu Road 16  
10117 Tallinn, Estonia  
P.O. Box 3926  
10509 Tallinn, Estonia  
Phone: +372 660 5910  
+372 660 5911  
Fax: +372 660 5912  
E-mail: aaa@aaa.ee  
Http://www.aaa.ee  
English, Russian,  
Estonian